

Access 3[®]



Cylinders and Keys



Introduction



Index

Introduction.....	2
Specifications & Features.....	3
System Administration	4
Quick Codes and Numbering	
Scheme Overview	5
Mortise Cylinders.....	6-8
Rim Cylinders.....	9
Large Format Interchangeable	
Core Cylinders	10
Component Cylinders for	
Cylindrical Locks	11
Cylinders for Deadbolts and	
Padlocks	12
Access 3 Pin Kits	13
Collars	14
Key Blanks/Key Sections.....	15
Master Keying & Keying Terms.....	16
Construction Master Keying	
(CMK).....	17
KeyWizard® Key Management	
Software.....	18
Architectural Specifications	19
Access 3 System Information	
Document Explanation.....	20
Access 3 System Information	
Document.....	21

The Access 3 Key System

The patented Access 3 system from Corbin Russwin provides the right level of security for each opening in a facility. Three levels of ANSI/BHMA Grade 1 protection, from patented keyway to UL437 certified, secures every opening. A common key for all three levels of security enhances key control and simplifies administrative procedures. Key blanks are controlled through authorized distribution and geographical protection is available. Available for mortise, rim, component and Large Format Interchangeable Core (LFIC) cylinders, Corbin Russwin offers the right level of access for every door in your facility.

Benefits

- Patent protection from unauthorized key duplication through 2027
- New keyway family protects system integrity from legacy systems
- Keys are significantly stronger than competitive systems
- User-friendly design with minimal components provides easy field service
- Availability in all existing Corbin Russwin cylinder types provides cost-effective upgrade for Corbin Russwin facilities
- Bump resistance for added protection

Access 3 - AP The first level of protection features a utility patented keyway and provides protection against bumping for mortise, rim and component fixed core cylinders. These cylinders easily retrofit into existing hardware and are appropriate for most applications. Keys for AP can only open AP cylinders.

Access 3 - AS This level builds on the utility patented keyway of AP and adds patented side bar locking with unique angled bottom pins that provide end users with geographical exclusivity. Cylinders provide protection against bumping and picking. Because of its superior key control and patent protection until 2027, AS cylinders are recommended for use in conjunction with AHS for new installations or when retrofitting systems.

Access 3 - AHS The highest level of security for the Access 3 key system. AHS combines utility patented keyway, side bar locking with unique angled bottom pins that provide end users with geographical exclusivity, and adds certification to UL437. AHS cylinders are classified as high security because of their superior resistance to physical attack and protection against unauthorized key duplication. Because of its superior key control, patent protection until 2027, and physical strength, we recommend AHS cylinders for new high-security installations or when retrofitting systems. Corbin Russwin also offers anti-vandal and high security locksets that complement AHS cylinders for those openings most vulnerable to attack.

Specifications & Features



Features of the Access 3 Key System

	AP	AS	AHS
Utility patented until 2027	X	X	X
Key blank distribution restrictions	X	X	X
Geographic exclusivity		X	X
Bump resistant	X	X	X
Common style pins	X		
Unique angled bottom pins		X	X
Convenient, simple to service	X	X	X
New keyway family and keying specifications from previous Corbin Russwin systems	X	X	X
Can be masterkeyed with all Access 3 levels	X	X	X
Certified to UL437			X

Product Specifications

All cylinders shall be utility patented, bump resistant and require the use of a patented key. All cylinders shall be available in any of the mortise, rim, key-in-knob/lever, auxiliary locks, padlocks or large format interchangeable core types.

Access 3 offers three distinct security options from which facilities can select the appropriate level of security for any door. Access 3's one key design allows the use of all three locking mechanisms within the same system to be operated with just one key. Access 3 provides the ultimate in key control by simplifying ordering processes and by allowing the system administrator to determine the level of protection for system components. Additional specifications are found on page 19.

Three levels of security.

Access 3 AP provides a utility patented keyway that protects against unauthorized key duplication until the year 2027 and is constructed to guard against bumping.

Access 3 AS consists of AP's utility patented keyway plus a sidebar and specially designed pins that increases the cylinders security and guards against attempts to be bumped or picked.

Access 3 AHS incorporates all the security features of AP and AS and is also specially constructed to guard against physical attack including drilling. It is certified to UL437.

Keying Specification

Keying

- Access 3 is a factory based key system
- 6 pin cylinders furnished with two nickel silver keys per cylinder. Access 3 cylinders may be furnished uncombined, master keyed, or grandmaster keyed to a specific facility. Double cylinder lock sets keyed alike on both sides will get two change keys total.
- Each level of Access 3 security (AP, AS, AHS) can be operated with just one key design.
- Access 3 systems are independent and cannot be keyed into existing and/or conventional Corbin Russwin master key systems
- Cross keying is not recommended. Key Systems Administration will review all requests and determine if compatible with a secured master key system

UL 437 Listed

Access 3 AHS cylinders are UL437 Listed. UL437 sets the standard for both drilling and picking resistances.

AHS cylinders are manufactured to include hardened drill resistant inserts in both the plug/barrel and body.

UL437 High Security cylinders are recommended for doors most likely to be physically assaulted, while the use of AP and AS cylinders are more advantageous and less costly for interior doors.

Patents

U.S. Utility Patent number 7,552,608 protects Access 3 keyways. Patent number 6,477,875 protects the sidebar and slider, and 6,945,082 protects the key blank, key and master key systems. Access 3 offers patent protection through 2027.

Product Certifications

ANSI/BHMA A156.5 Grade 1
E09211 (Mortise)
E09221 (Rim)
E09231 (Cylindrical Lock Cylinders)



Applications

Access 3 is recommended for installations requiring patented key control protection including picking and/or drilling, in one locking system. Access 3 is ideally suited for Educational and Healthcare facilities, Industrial and Commercial buildings.

System Administration



Access 3 System Administration

All Corbin Russwin Access 3 key systems must have a signed System Information Document (SID), located in the back of this catalog and available online, for each facility. The SID designates a primary systems administrator for the facility. Unless otherwise indicated by the primary systems administrator by way of a separate specific letter of authorization, all shipments for Access 3 product will go to the shipping address on the Systems Information Document.

All key blanks are to remain in the possession of the facility and must be accounted for. Any factory defect or incorrectly cut keys must be returned to the factory. All damaged or incorrectly field cut keys must be destroyed.

For AS and AHS, specific randomized security codes will be required for each order unless the systems administrator opts out of this feature. For more information, see the Systems Information Document.

Keyway Administration and Assignment

All keyways will be noted on the master key system bitting list. Corbin Russwin Key System Administration will assign all Access 3 keyways. Keyways will be assigned according to facility type, geographic location and keying system specifications. Unless otherwise authorized, all keys will ship directly to the end user. All master key systems will be registered with Key Systems Administration and all bittings will be factory created.

Key Control

Key control will be maintained by complying with the Corbin Russwin Security Policy. For a copy, contact Key System Administration or visit our web site at www.corbinrusswin.com. System information and/or systems-related product will be forwarded directly to the owner, unless otherwise indicated by the owner's appointed administrator.

Authorized Distributors

Corbin Russwin Access 3 is a system based product and is provided through authorized distribution. An authorized distributor may stock and service products upon specific written authorization from the primary system administrator of the facility. Authorized distributors who carry inventory for a specific facility's system must provide valid receipts and disbursements of all products, specifically key blanks/cut keys. All key blanks in the possession of an authorized distributor must be accounted for. Any defective, incorrectly cut or damaged key blanks must be destroyed. Refer to pages 20-21 for a copy of the SID and more information.

Quick Codes and Numbering Scheme Overview



Access 3 Quick Codes

AP	Patented Keyway
AS	Security Cylinder
AHS	High Security UL437
ACP	Patented Keyway - Interchangeable Core
ACS	Security - Interchangeable Core
ACHS	High Security UL437 - Interchangeable Core

Access 3 Keying Options Quick Codes

CMK**	Construction master keyed
UC***	Uncombined

**CMK is not available with hotel function cylinders or large format interchangeable cores. If construction master keying is required for LFIC, specify temporary construction cores CTAHD or CT6AHR/B/G.

***UC is not available with AHS cylinders

Access 3 Temporary Core Options Quick Codes

CT6R	IC 6-pin temporary core - Red (AP and AS)
CT6B	IC 6-pin temporary core - Blue (AP and AS)
CT6G	IC 6-pin temporary core - Green (AP and AS)
CTD	IC 6-pin disposable core (AP and AS)
CL6	IC 6-pin less core (AP and AS)
CT6AHR*	IC 6-pin temporary core - Red (AHS only)
CT6AHB*	IC 6-pin temporary core - Blue (AHS only)
CT6AHG*	IC 6-pin temporary core - Green (AHS only)
CTAHD*	IC 6-pin disposable core (AHS only)
CL6AH*	IC 6-pin less core (AHS only)

* Not available for cylindrical locks, DL2200/DL3200 Dead Bolts and A6/N6/PR6 Exit Trims.

How to Order Access 3 Cylinders

15				0		0		114		A01		6		CRA1		x Finish						
Cylinder Type				Mechanism		Function		Length		Cams		Pins		Keyway								
Mortise	AP	1	5	0	Standard	0	Standard	114	1-1/4" (32mm)	A01	6	CRA1	CRA1	x	Finish							
	AS	1	6			1	Hotel			A02			CRA2									
	AHS	1	7			8	UL Housing			A03			CRB1									
KIK/KIL	AP	2	5		7	Mortise Cylinder	138		1-3/8" (35mm)	A04		6	CRA1		CRB2							
	AS	2	6							A05					CRC1							
	AHS	2	7							A06					CRC2							
Competitor K/L	AP	2	3			8			Mortise Cylinder	112			1-1/2" (38mm)		A07			6	CRA1	CRD1		
	AS	2	8												A02					CRD2		
	AHS	2	9												A03							
Rim	AP	3	5						8	Mortise Cylinder			134		1-3/4" (44mm)				A04	6	CRA1	
	AS	3	6																A05			
	AHS	3	7																A06			
IC core	AP	8	5	8				IC Complete Cylinder (LFIC)		7	LFIC Housing		A07	6	CRA1							
	AS	8	6										A08									
	AHS	8	7										A09									

Access 3 Designations

AP	Patented Keyway
AS	Security Cylinder
AHS	High Security Cylinder

Description	Specify
Bright Brass	605
Satin Brass	606
Bright Bronze	611
Satin Bronze	612
Dark Oxidized Satin Bronze, Oil Rubbed	613
Dark Oxidized Satin Bronze – Equivalent	613E
Bright Nickel Plated	618
Satin Nickel Plated	619
Flat Black Coated	622
Bright Chromium Plated	625
Satin Chromium Plated	626
Bright Stainless Steel	629
Satin Stainless Steel	630
Black Oxidized Bronze, Oil Rubbed	722

Mortise Cylinders



Mortise Cylinders

For use with the following products:

- ML2000 Series mortise locks (including electrified and EAC devices)
- DL3000 and DL4100 deadlocks
- ED5600, ED6600 and ED7600 exit devices
- All ED5000 cylinder dogging, alarm units, delayed egress cylinders

Access 3 Mortise Cylinders supplied with:

- Solid brass, 6 pin cylinder, 1-5/32" (29mm) diameter
- New keyway family - see page 15 for available keyways.

Mortise Cylinders

Type	Length	Cam	Finish
Fixed Core:	114 - 1-1/4" (32mm)	A01 - Steel case mortise locks except classroom and institutional privacy functions.	605 - Bright Brass
1500 - AP Type	138 - 1-3/8" (35mm)	Deadbolt functions of green cast iron case mortise locks. NOT for master ring mortise cylinders.	606 - Satin Brass
1501 - AP Type Hotel	112 - 1-1/2" (38mm)	A02 - Steel case mortise lock classroom (55), inside of vestibule (42) and institutional privacy (69) functions. Most exit device trims. NOT for master ring mortise cylinders.	611 - Bright Bronze
1600 - AS Type	134 - 1-3/4" (44mm)		612 - Satin Bronze
1601 - AS Type Hotel			613 - Dark Oxidized Satin Bronze - oil rubbed
1700 - AHS Type			613E - Dark Oxidized Satin Bronze – equivalent
1701 - AHS Type Hotel			618 - Bright Nickel Plated
Interchangeable Core:		A03 - DL3000 Series Cylindrical Deadlocks only.	619 - Satin Nickel Plated
1580 - AP Type		A04 - DL4000 Series Mortise Deadlocks only.	622 - Flat Black Coated
1680 - AS Type		A05 - 4070 Series Deadlocks	625 - Bright Chromium Plated
1788 - AHS Type		A06 - Schlage® L9000 Series (Cloverleaf only)	626 - Satin Chromium Plated
1078 - UL 6-Pin Housing		A07 - DL4100 Series	629 - Bright Stainless Steel
		A62 - Mortise Series Master Ring classroom (55) function and inside of vestibule (42) function mortise locksets.	630 - Satin Stainless Steel
		900 Series Mullion, WS700 Series Mullion (Both KRM)	722 - Black oxidized bronze, oil rubbed
		A92 - Concealed vertical rod exit device outside grip handle operators 01 and 02.	

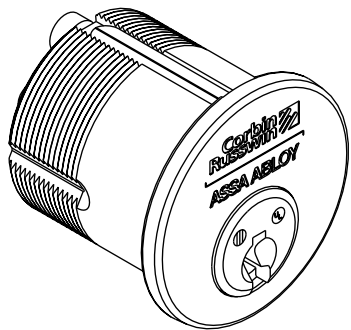

Mortise Fixed Core

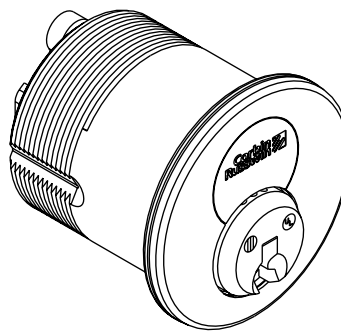

Mortise Interchangeable Core

Mortise Cylinders



How to Order Examples

Access 3 Fixed Core Mortise Cylinder Ordered Separately

Quantity	Keyset	Cylinder	Length	Cam	Keyway	Finish
50	AA1	1500	114	A01	CRA1	626

Access 3 Fixed Core Mortise Cylinder Ordered with a Mortise Lock

Quantity	Keyset	Series/Function	Trim	Keyway	Finish	Hand	Access 3 Quick Code
50	AA1	ML2051	LSA	CRA1	626	RHR	AP, AS or AHS

Access 3 Interchangeable Core Mortise Cylinder Ordered Separately

Quantity	Keyset	Cylinder	Length	Cam	Keyway	Finish	Collar *
50	AA1	1580	114	A01	CRA1	626	610F02

Access 3 Interchangeable Core Cylinder Ordered with a Mortise Lock

Quantity	Keyset	Series/Function	Trim	Keyway	Finish	Hand	Access 3 Quick Code
50	AA1	ML2051	LSA	CRA1	626	RHR	ACP, ACS, ACHS

Access 3 Interchangeable Temporary Core Cylinders Ordered with a Mortise Lock

Quantity	Keyset	Series/Function	Trim	Finish	Hand	Access 3 Quick Code**
50	AA1	ML2051	LSA	626	RHR	CT6AHR

Access 3 Interchangeable Core Mortise Housings Only

Quantity	Housing	Length	Cam	Finish
50	1070 (AP & AS), 1078 (AHS)	114	A01	626









*See page 14 for collar quick codes.

**See page 5 for Temporary Core Options Quick Codes

Cams for Mortise Cylinders



Cams for current products or models

Cam	Type	Part Number	Brand	Model/Description
	A01	756F50	Corbin Russwin	Steel case mortise locks except classroom and institutional privacy functions. Deadbolt functions of green cast iron case mortise locks. NOT for master ring mortise cylinders.
			Arrow®, Marks 5000, PDQ	All mortise functions using Cloverleaf cam.
	A02	756F51	Corbin Russwin	Steel case mortise lock classroom (55), inside of vestibule (42) and institutional privacy (69) functions. Most exit device trims. NOT for master ring mortise cylinders.
			Baldwin	All mortise locks.
			R. R. Brink	All except CKS.
			Marks	7000, 9000 and most brands of older black cast iron locks.
	A03	756F52	Corbin Russwin	DL3000 Series Cylindrical Deadlocks only.
			Adams Rite®	1800 Series, 4015 Deadlocks; 4500 and 4700 Series Latch Locks.
			Lori	4500, 4600 Series Deadlocks.
	A04	756F53	Corbin Russwin	DL4000 Series Mortise Deadlocks only.
	A05	756F54	Adams Rite®	4070 Series Deadlocks.
			R. R. Brink	"CKS" Control Key Switch.
	A06	756F55	Schlage®	L9000 Series (Cloverleaf only).
	A07	756F56	Corbin Russwin	DL4100 Series Deadlocks
	A62	756F58	Corbin Russwin	Mortise Series Master Ring classroom (55) function and inside of vestibule (42) function mortise locksets. 900 Series Mullion, WS700 Series Mullion (Both KRM)
			DORMA	Mortise Locks
	A92	756F62	Corbin Russwin	Concealed vertical rod exit device outside grip handle operators 01 and 02.

Rim Cylinders



Rim Cylinders

For use with Exit Devices and Auxiliary Locking Devices

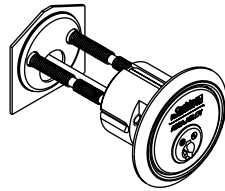

Access 3 Rim Cylinders supplied with:

- Solid brass, 6 pin cylinder, 1-5/32" (29mm) diameter
- New keyway family - see page 15 for available keyways.
- Surface mounted collar 422F88 furnished when cylinders are ordered with locking devices.
- Supplied with back plate and 2 breakaway screws.

Rim Cylinders

Type	Length	Part Number	Availability		Finish
			FC	IC	
Fixed Core: 3500 - AP Type 3600 - AS Type 3700 - AHS Type	058-5/8" (16mm) tailpiece	655F008 (FC) 655F018 (IC)	X	X	605 - Bright Brass 606 - Satin Brass 611 - Bright Bronze 612 - Satin Bronze 613 - Dark Oxidized Satin Bronze - oil rubbed 613E - Dark Oxidized Satin Bronze - equivalent 618 - Bright Nickel Plated 619 - Satin Nickel Plated 622 - Flat Black Coated 625 - Bright Chromium Plated 626 - Satin Chromium Plated 629 - Bright Stainless Steel 630 - Satin Stainless Steel 722 - Black oxidized bronze, oil rubbed
	114 - 1-1/4" (32mm) M61 & M62 option for ED8200 and ED9200 exit device alarms	582F298		X	
Interchangeable Core: 3580 - AP Type 3680 - AS Type 3780 - AHS Type 3078 - UL 6-Pin Housing	138 - 1-3/8" (35mm) M61 & M62 option for ED8200 and Obsolete ED9200 exit device alarms; for ED5202(S)(A) inside cylinder	490F558	X		
	178 - 1-7/8" tailpiece (48mm) (Std. Door)	253F858		X	
	178V - 1-7/8" (48mm) vertical tailpiece	483F098		X	
	200 - 2" (51mm) tailpiece	253F768	X		
	200N - 2" (51mm) tailpiece ED4000/ED5000 Night Latch Function	253F768	X		
	200V - 2" (51mm) vertical tailpiece	413F488	X		
	312 - 3-1/2" (89mm) tailpiece	253F778	X		
	312V - 3-1/2" (89mm) vertical tailpiece	413F498	X		
318 - 3-1/8" (79mm) tailpiece	284F138		X		

How to Order Examples

Access 3 Fixed Core Rim Cylinder Ordered Separately

Quantity	Keyset	Cylinder	Length	Keyway	Finish
50	AA1	3500, 3600 or 3700	200	CRA1	626

Access 3 Fixed Core Rim Cylinder Ordered with an Exit Device

Quantity	Keyset	Series/Function	Trim	Keyway	Finish	Hand	Access 3 Quick Code
50	AA1	ED5200	L955	CRA1	630	RHR	AP, AS or AHS

Access 3 Interchangeable Core Rim Cylinder ordered Separately

Quantity	Keyset	Cylinder	Length	Keyway	Finish
50	AA1	3580, 3680 or 3788	178	CRA1	626

Access 3 Interchangeable Core Rim Cylinder Ordered with an Exit Device

Quantity	Keyset	Series/Function	Trim	Keyway	Finish	Hand	Access 3 Quick Code
50	AA1	ED5200	L955	CRA1	630	RHR	ACP, ACS, ACHS

Access 3 Interchangeable Temporary Core Cylinders Ordered with an Exit Device

Quantity	Keyset	Series/Function	Trim	Finish	Hand	Access 3 Quick Code**
50	AA1	ED5200	L955	626	RHR	CT6AHR, CT6AHB or CT6AHG

Access 3 Interchangeable Core Rim Housings Only

Quantity	Keyset	Housing	Length	Finish
50	AA1	3070 or 3078	178	626

**See page 5 for Temporary Core Options Quick Codes

Large Format Interchangeable Core Cylinders



Interchangeable Core

For use with Corbin Russwin's 6-pin Interchangeable Core housings & shells.*

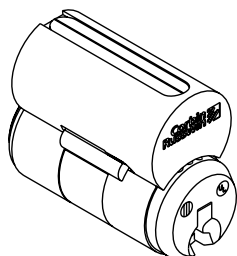

Type	Finish
8500 - AP Type	605 - Bright Brass
8600 - AS Type	606 - Satin Brass
8700 - AHS Type	611 - Bright Bronze
	612 - Satin Bronze
	613 - Dark Oxidized Satin Bronze - oil rubbed
	613E - Dark Oxidized Satin Bronze – equivalent
	618 - Bright Nickel Plated
	619 - Satin Nickel Plated
	622 - Flat Black Coated
	625 - Bright Chromium Plated
	626 - Satin Chromium Plated
	722 - Black oxidized bronze, oil rubbed

*8700 core must be used with 1078 or 3078 housings to maintain UL437 listing

Driver Assemblies

For use with LFIC cores

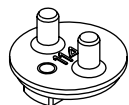

LFIC

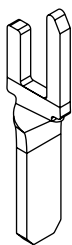

CL3300

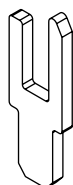

CL3100

Part No.	Driver Type
631F188	Driver, LFIC (114)
631F198	Driver, LFIC (138)
631F208	Driver, LFIC (112)
631F215	Driver S/A LFIC (134)
631F238	Driver, CL3300 Series
631F258	Driver, CL3100 Series

How to Order Examples

AS Security Interchangeable Core Ordered Separately

Quantity	Keyset	Cylinder	Keyway	Finish
50	AA1	8600	CRA1	605

Component Cylinders for Cylindrical Locks



For use with all Corbin Ruswin lever and knob cylindrical locks.

Access 3 Fixed Core Component Cylinder for Corbin Ruswin's Products

Type	Tailpiece	Lockset	Part Number	Finish
2500 - AP Type 2600 - AS Type 2700 - AHS Type	031	CL3100 Series Vandal Resistant	778F778	606 - Satin Brass 626 - Satin Chrome
	031H	CK4300 Knob	778F778	
	033	CL3300, CL3500, CL3600 (June 2000 and after), CL3800, Lever Trim - A6/N6/PR6	622F308	
	033H	G10 Exit Device Knob Trim	622F308	
	037	CL3700 Lever, CK4700 Knob	682F298	
	039	CL3900	680F608	
	039L	CL3900 Lever (2" and 2-1/4" Thick Door)	671F068	
	044	CK4400	N/A	
2501 - AP Type 2601 - AS Type 2701 - AHS Type	031	CL3100 Series Vandal Resistant	778F778	
	034	CL3300	622F308	

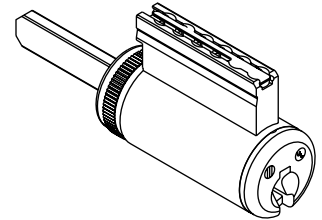

Access 3 Fixed Core Component Cylinder for Other Manufacturer's Products

Type	Tailpiece	Lockset	Finish
2300 - AP Type 2800 - AS Type 2900 - AHS Type	001-C21	Schlage D Series Lever Arrow H Series Knobs and Levers Sargent 10 Line	606 - Satin Brass 626 - Satin Chrome
	001-C22	Schlage AL and ND Series Levers	
	002-C21	Schlage D Series Knobs	
	002-C22	Schlage A Series Knobs (Ply, etc.)	
	002-C23	Schlage A Series Knobs (ORB only)	

How to Order Examples

Access 3 Fixed Core Component Cylinder Ordered Separately

Quantity	Keyset	Cylinder	Tailpiece	Keyway	Finish
50	AA1	2500	033	CRA1	626
50	AA1	2300	001-C21	CRA1	626

Access 3 Fixed Core Component Cylinder With Lockset

Quantity	Keyset	Series/Function	Trim	Keyway	Finish	Quick Code
50	AA1	CL3357	PZD	CRA1	626	AP, AS or AHS

Access 3 Interchangeable Core Cylinder Ordered With Lockset

Quantity	Keyset	Series/Function	Trim	Keyway	Finish	Quick Code
50	AA1	CL3357	PZD	CRA1	626	ACP, ACS, ACHS

Cylinders for Deadlocks and Padlocks



Deadlocks - DL2200/DL3200 Fixed Core Cylinders

Cylinder Type	Tailpiece	Deadbolt Function	Keyway	Finish
4500 - AP Type	134-A51	11, 13, 17	CRA1	606 - Satin Brass 626 - Satin Chrome Plated
4600 - AS Type	134-A52	12 (for 1-3/8" & 1-3/4" Door)		
4700 - AHS Type	214-A52	12 (for 2" & 2-1/4" Door)		

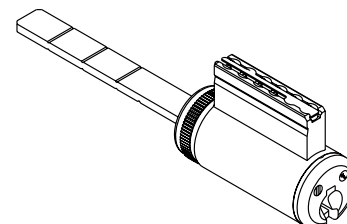

How to Order Examples

Access 3 Fixed Core Cylinder for DL2200/DL3200 Ordered Separately

Quantity	Keyset	Cylinder	Tailpiece	Keyway	Finish
50	AA1	4500	134-A51	CRA1	606

Deadlock with Access 3 Fixed Core Cylinder

Quantity	Keyset	Series/Function	Keyway	Finish	Quick Code
50	AA1	DL2213	CRA1	626	AP, AS or AHS
50	AA1	DL3213	CRA1	626	AP, AS or AHS
50	AA1	DL4113	CRA1	626	AP, AS or AHS

Deadlock with Access 3 Interchangeable Core Cylinder

Quantity	Keyset	Series/Function	Keyway	Finish	Quick Code
50	AA1	DL2213	CRA1	626	ACP, ACS or ACHS
50	AA1	DL3213	CRA1	626	ACP, ACS or ACHS
50	AA1	DL4113	CRA1	626	ACP, ACS or ACHS

Deadlock with Mortise UL IC 6-Pin Housing

Quantity	Keyset	Series/Function	Keyway	Finish	Quick Code
50	AA1	DL3213	CRA1	626	CT6AH (R/B/G), CTAHD OR CL6AH
50	AA1	DL4113	CRA1	626	CT6AH (R/B/G), CTAHD OR CL6AH

Cylinders must be ordered separately for DL3000 and DL4100 Series deadlock cylinders, see page 6.

Padlocks - Interchangeable Core Cylinders

Cylinder Type	Shackle	Keyway	Finish
8500 - AP Type 8600 - AS Type 8700 - AHS Type	7/8", 2-3/8"	CRA1	606 - Satin Brass

Fixed core cylinders not available.

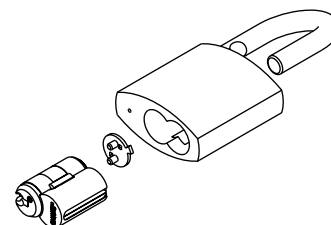

How to Order Example

Padlock with Access 3 Interchangeable Core Cylinder

Quantity	Keyset	Series/Function	Keyway	Shackle Length	Finish	Cylinder
50	AA1	PL5070	CRA1	7/8"	606	ACP, ACS or ACHS
50	AA1	PL5170	CRA1		606	ACP, ACS or ACHS
50	AA1	PL5270	CRA1		606	ACP, ACS or ACHS

PK-30-AP Pinning Kit

The PK-30-AP Kit is used to pin AP fixed and LFIC cylinders. The heavy duty steel kit prevents pins from mixing.

The kit includes:

- 100 each of bottom pins sizes 1-6
- 100 each of build up pins 1-11
- 100 each of master pins sizes 1-5
- 100 each of top pins sizes 1-9
- 100 each of bump resistant pins sizes 4-9
- 100 tumbler springs – part number 763F617
- 25 KIK/KIL/DB spring cover – part number 756F858
- 25 mortise/rim/LFIC spring cover – part number 756F722
- 10 sidebar – part number 763F565
- Tweezer – part number 239F368
- Access 3 Key gauge – part number 756F937

PK-30-MASTER Master Pinning Kit

The PK-30-MASTER “Master Kit” includes all pins needed to re-pin AP, AS and AHS cylinders.

The kit includes:

- 100 each of angled bottom pins sizes 1-6 (L-R-C)
- 100 each of AP bottom pins sizes 1-6
- 100 each of build up pins sizes 1-11
- 100 each of master pins sizes 1-5
- 100 each of top pins sizes 1-9
- 100 each of bump resistant pins sizes 4-9
- 100 tumbler springs – part number 763F617
- 25 KIK/KIL/DB spring cover – part number 756F858
- 25 mortise/rim/LFIC spring cover – part number 756F722
- 10 Sidebar – part number 756F807
- 10 sidebar – part number 763F565
- 10 sidebar spring – part number 756F817
- 10 slider spring – part number 756F797
- 10 screw – part number 756F847
- Tweezer – part number 239F368
- Access 3 Key gauge – part number 756F937

See the Technical Manual for individual part numbers.

Collars



Collars

- 1-3/4" (44mm) thick door. For other door thicknesses and trim considerations, contact Corbin Russwin Technical Product Support.
- Mortise Cylinders – 1-1/4" (32mm) length

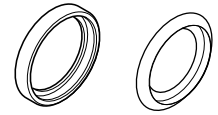

	Spring		Solid									Surface Mount
	605F43 (.350)	447F41 (.030)	700F53 (.090)	270F15 (.156)	598F89 (.156)	447F42 (.172)	610F02 (.289)	447F43 (.375)	654F07 (.350)	267F97 (.635)	422F88 (.000)	
Mortise Cylinder												
AP Separately (1500, 1580)	x											
AS & AHS Separately (1600, 1680, 1700, 1788)							x					
Mortise Lock												
Single Cylinder												
Sectional							x					
L Escutcheon		x										
N Escutcheon					x							
P Escutcheon					x							
M Escutcheon					x							
R Escutcheon		x										
T Escutcheon (no collar required)												
Double Cylinder												
Sectional								x				
L Escutcheon						x						
N Escutcheon							x					
P Escutcheon							x					
M Escutcheon							x					
R Escutcheon						x						
T Escutcheon						x						
V Escutcheon			x									
Auxiliary Locks												
DL4011, 4013, 4017, DL4100						x						
DL4012, DL4102								x				
Rim Cylinder												
AP Separately (3500, 3580)												x
AS & AHS Separately (3600, 3680, 3700, 3788)												x
Exit Devices												
ED4000-5000 Series												
700 Trim, F2, F3, T13, P9									x			
K1				x								
700M Trim, F2M, F3M, T13M							x					
900 Trim												x
Cylinder Dogging				x								
ED6000 Series												
N3, G4, T3				x								
N4M, G5M												x
T7M, T9M X					x							
ED7000 Series												
P4, P6, P7		x										
C4, O3, O5												x
T11												
ED8000 Series												
KO												x
F1, P1, P2 (no collar required)												

Collar Options - Mortise and Rim Cylinders Only

Description	Quick Code
Collar packet (549F52 + 253F97)	428F66
Rim collar, flush mount	255F53
Rim collar, flush mount (master ring)	255F54
Rim collar, surface mount (standard for rim cylinders)	422F88
Solid collar - .030	447F41
Solid collar - .031 (master ring)	447F44
Solid collar - .090 (VR trim only)	700F53
Solid collar - .094	261F54
Solid collar - .094 (master ring)	261F55
Solid collar - .156	270F15
Solid collar - .156	598F89
Solid collar - .172 (tapered security collar)	416F39
Solid collar - .172	447F42
Solid collar - .172 (master ring- standard for MR 118 cylinders)	447F45
Solid collar - .221	610F01
Solid collar - .289	610F02
Solid collar - .312	303F25
Solid collar - .350	654F07
Solid collar - .375	447F43
Solid collar - .375 (master ring)	447F46
Solid collar - .500	609F36
Solid collar - .510	134F05
Solid collar - .550	654F08
Solid collar - .635	267F97
Solid collar - .650	609F37
Solid collar - .749	399F47
Solid collar - .850	609F38
Spacer for flexible head cylinders - .125	370F29
Spacer for flexible head cylinders - .250	370F31
Spacer for flexible head cylinders - .315	252F82
Spacer for flexible head master ring cylinders - .094	370F33
Spacer for flexible head master ring cylinders - .281	370F35
Spacer for flexible head master ring cylinders (tapered) - .090	366F70
Spring collar - .150 (standard for 118 cylinders)	253F97
Spring collar - .219	549F52
Spring collar - .350 (standard for 114 cylinders)	605F43

Key Blanks/Key Sections



For Multiplex Masterkey Systems (CR keyway family shown)

Nickel silver
Key Bow type 38

- Ordering example AP Key Blank:**

XXXX-6PIN-38-AP
└── Keyway

- Ordering example AS/AHS Key Blank:**

XXXX-6PIN-38-AS60
└── Keyway

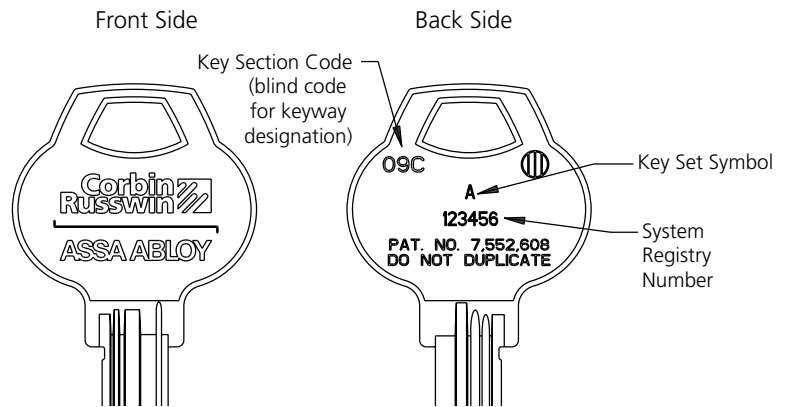

- Ordering example Hotel Emergency key (Mortise AP Cylinders)**

example: Keyway-6Pin-38-E2-AP

- Ordering example Hotel Emergency key (Key-in-Lever, AS or AHS Cylinders)**

example: Keyway-6Pin-38-E6-AS60

Back Side Stamping & Options

- Key set (VKC1), standard – unless otherwise indicated
- System registry number will be stamped on master keys unless otherwise indicated
- Concealed key control (CKC2) available on cylinders
- Visual Key Control VKC2 is available for level 1 (AP) only
- Visual Key Control VKC3 and Concealed Key Control CKC3 not available

Keyway Security

Access 3 keyways will be determined by the supervisor of Key Systems Administration. Assignment will be based on the overall system requirements and geographic location to provide maximum protection to the owner. For security reasons, the keyway profiles are not shown.

Keyway Group

All section – CRAD

Multi-section – CRAB - CRCD

Multi-section – CRA - CRB - CRC - CRD

Keyway – CRA1 - CRA2 - CRB1 - CRB2 - CRC1 - CRC2 - CRD1 - CRD2

Sample Keyway - MB

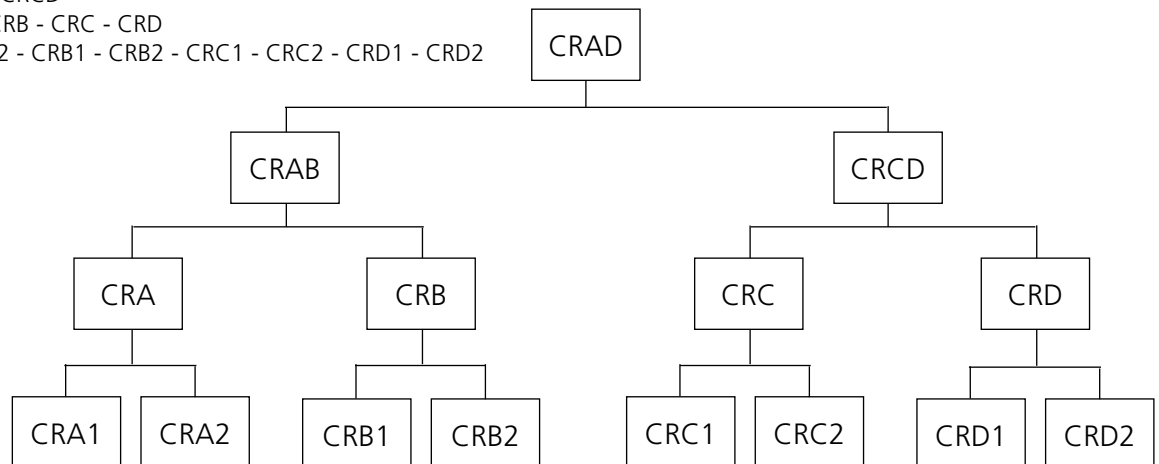

Master Keying and Keying Terms



Corbin Ruswin requires all orders containing Master Keying details to be submitted using the industry standard Door and Hardware Institute (DHI) ANSI/BHMA format. Key symbols used on a master keyed order require combinations of letters and/or letters and numbers.

For complete details on proper structuring format of key symbols refer to: ANSI/BHMA Standard A156.28, AMERICAN NATIONAL STANDARDS FOR KEYING SYSTEMS; or contact CORBIN RUSSWIN for assistance at 1-800-438-1951.

Basic Keying Terms

Keys	Abbreviation	Definition
Change key	CK	Individual lock key
Masterkey	MK	Operates any given quantity of cylinders with different key changes
Grand Masterkey	GMK	Operates all individual locks already operated by masterkey(s)
Great Grand Masterkey	GGMK	Operates all locks under the various masterkey(s) and grand master key(s) already established
Construction Master Key	CMK	Operates all cylinders designated for a temporary period during construction
Control Key	CTL	Key to install or remove interchangeable or removable cores
Keyway	KWY	Broaching in a cylinder plug
Key section	KWY	Sidewarding on key to match broaching in plug
Single keyed	SKD	Cylinders operated by their change key only; not operated by any master key

For complete master key system design information and instructions refer to ASSA ABLOY's Master Key System Design Guide.

The following codes and definitions have been established for specifying cylinder and key stamping for Access 3 cylinders and keys:

Note: All keys will have a key section code. For determining the actual key section contact the factory.

Quick Code	Definition
VKC0	No keyset, registry number, nor bitting stamping on any keys. Includes master keys and change keys. (Keys will be tagged.)
VKC1	Master keys stamped with their keyset symbol and registry number. Change keys stamped with their keyset symbol. (Standard for AP, AS and AHS.)
VKC2	Master Keys stamped with their keyset symbol and registry number. Change keys stamped with their keyset symbol. Cylinders stamped with their keyset symbol on the face of the plug. (Not available for AS and AHS.)
VKC3	Master Keys stamped with their registry number. Change keys stamped with their bitting. Cylinders stamped with their keyset symbol on the face of the plug. (Not available for AS and AHS.)
CKC2	Master keys stamped with their keyset symbol and registry number. Change keys stamped with their keyset symbol. Cylinders stamped with their keyset symbol in a concealed location.
CKC3	Master keys stamped with their registry number. Change keys stamped with their bitting, keyway* and system. Cylinders stamped with their keyset symbol in a concealed location. (Not available for AS and AHS cylinders.)

Construction Master Keying



Construction Master Keying (Lost Wafer Design)

Corbin Russwin master keyed Access 3 cylinders can be ordered with the convenience of construction master keying.

Construction master keying simplifies the process when the building gets turned over. With this feature, the cylinder is master keyed with a special construction feature in one of the chambers. The plug is prepped in two places along both sides of the same chamber containing the construction feature. This allows the construction master key to be used during the construction phases.

It is highly recommended that all construction keys are collected and accounted for once the project is complete to protect the integrity of the key system.

Orders to existing key systems that require additional construction master keys are to be specified and ordered separately.

Orders with construction master keying will have all change keys shipped separately from hardware.

Construction master keying is not available with hotel function cylinders or large format interchangeable cores. If construction keying is required for LFIC, specify temporary construction cores, CTAHD or CT6AHR/B/G. See page 5 for complete options.

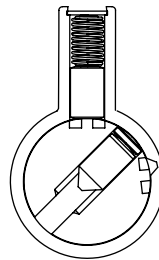
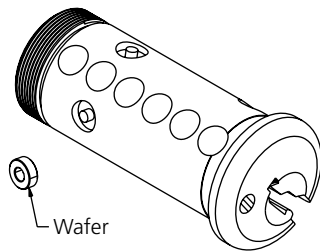

Cutaway cylinder showing construction master key being used, putting the wafer below the shear line while key is turned. Note the two empty "donut" holes on either side of the chamber.

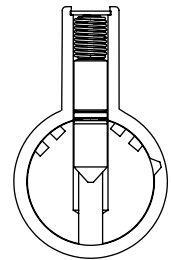

Change key inserted in cylinder putting the wafer at the shear line.

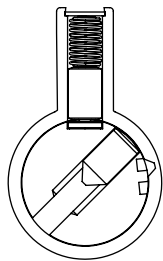

As change key rotates, construction wafer falls into "donut" hole in the side of plug. Only construction wafer will fall due to hole through its center.

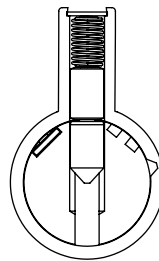

Change key rotated to position for extraction.

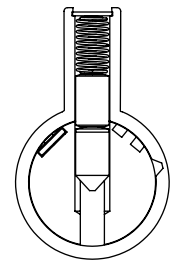

Construction master key inserted after wafer is trapped. Driver now extends into plug chamber. Construction master key, if used, will not rotate.

KeyWizard® Key Management Software



Corbin Ruswin's KeyWizard® 5.5 Software Package Tracks Multiple Key Systems Including Keys, Keyholders, Locations, and Hardware Information

This comprehensive key management software package was developed for locksmiths and end-users to track detailed information. The program features easy to navigate, non-cluttered screens and uses a format similar to Microsoft® Outlook™.

Features:

- Free Technical Support at 1-800-610-1706 and system upgrades for 1 year
- Website support at www.keywizard.net
- Multi-level passwords and access levels
- Clear, easy to read screens
- Manages multiple end user key systems
- Customized query, reporting and search capability
- Global searching across multiple key systems
- Comprehensive hardware schedules
- Keyholder photos and signatures for identity verification
- Scheduled maintenance and reminders for overdue keys and back-ups
- Accurate key symbol sorting
- Multi-level key authorizations and key deposits
- Network and stand-alone versions
- Pinning calculators
- Reports options including printing in a variety of formats and e-mail
- Cylinder and key random serial ID generator
- Key authorization forms that can be printed at will
- Editable field titles
- Ability to connect to a website and search for any updates

How to Order	Part Number
Single License Version	KW-SS1
Network Version	KW-SSN1
Demonstration Version	KW-DEMO1
KeyWizard® replacement for KeyMinder (Consult factory for eligibility requirements) Single License Version	UP-KW-SS1
Network Version	UP-KW-SSN1



Computer System Recommendations:

REQUIRED:

- 350 MHz processor
- 60 MB hard disk space
- Windows® 7, Vista, XP, NT, ME, 2000 or 98
- 64MB Ram
- CD drive

Architectural Specifications



Part 1 – General

Keying Schedule;

- The keying schedule is just as important as the hardware schedule
- The key meeting requirements;

Who attends

Example; "Upon approval of the finish hardware schedule meet with the owner's representative to determine the project's keying requirements. In attendance shall be a Certified Key System Specialist".

Administrative documents should be reviewed and executed at this meeting.

Delivery, Storage and Handling;

- The delivery & storage of the permanent cylinders, cores, keys, key control software.

Extra Material;

- Consideration should be given to include additional permanent cylinders, key blanks and key cutting equipment, etc.

Part 2 – Product

Keying: (Corbin Russswin Access 3)

All cylinders shall be Access 3 by Corbin Russswin. Provide utility patented cylinders that require the use of a patented controlled key. Provide bump resistant fixed core mortise and rim cylinders standard. Except where otherwise specified all locksets, exit devices and cylinders shall be of the same manufacturer. Provide recessed cylinder collars for all mortise and rim cylinders. Establish a new multilevel factory designed secured master key system for this project that will meet the owners requirements for this project and future expansion. All keying shall be done at the factory where permanent records will be established and maintained. Manufacturer to have a minimum of 10 years experience designing secured master key systems and have a published security policy.

Provide a 6 pin multilevel master key system which is comprised of patented controlled keys, security and high security cylinders that can all be operated by ONE key of the highest level. Geographical exclusivity shall be provided for all security and high security cylinders. Provide certified cylinders meeting ANSI/BHMA A156.5-2010 Grade 1. Provide mortise, rim, LFIC and key-in-lever cylinders certified to UL437 where specified.

Provide construction master keying for all fixed core cylinders. Provide temporary keyed cores for all large formatted interchangeable core cylinders. Permanent keys and cores are to be delivered directly to the owner or owner's representative. Provide nickel silver keys with industry standard Visual Key Control stamping on the bow only for each permanent cut key. Furnish keys in the following quantities.

- 1 each top master key for the system(s)
- 4 each Change keys per cylinder or 10 keys per keyed alike group
- 2 each Control keys (if required)
- 2 each Master keys per master key group and/or selective master key
- 2 each Construction control keys (if required)
- 12 each Construction keys
- Provide 1 copy of bitting list to the owner

Where specified AP; provide utility patented controlled keyway cylinders that are furnished with patented keys that are only available from authorized distribution. Provide bump resistant fixed core mortise and rim cylinders standard. Where specified AS; provide utility patented controlled keyway and side bar locking incorporating unique angled bottom pins that provide end users with geographical exclusivity. Cylinders shall be constructed to provide protection against bumping and picking. Where specified AHS; provide utility patented controlled keyway and side bar locking incorporating unique angled bottom pins that provide end users with geographical exclusivity. Cylinders shall be constructed to provide protection against bumping, picking and drilling. Provide mortise, rim, LFIC and key-in-lever cylinders certified to UL437.

Specified manufacturer Corbin Russswin Access 3 Key Control

- Specify Key Wizard software.

Part 3 – Execution

Care should be taken to identify the required process of turning over a patented locking system to the owner.

System Information Document Explanation



Access 3 AP Required Administrative Documents:

- **Mandatory:** all new systems will require a completed System Information Document (orders cannot be entered without this document). The fully executed original document will be kept on file at Corbin Russwin Key System Administration.
- **Subsequent order requirements:** A letter of authorization will be required if the product is shipped to an address other than what's recorded on the System Information Document and/or if the address on the purchase order is different than what is listed on the System Information Document.

Access 3 AS and AHS Required Administrative Documents:

- **Mandatory:** all new systems will require a completed System Information Document (orders cannot be entered without this document). The fully executed original document will be kept on file at Corbin Russwin Key System Administration.
- **Subsequent order requirements:** A specific randomized security code will be required for each order unless "Opt- Out" has been authorized by the systems administrator.
- If the "Opt Out" option is NOT selected
 - A correct system specific (randomized) security code must be included with each subsequent order.
 - Security codes are specific to each order.
 - If the shipping address is other than the one listed on the System Information Document, a Letter of Authorization signed by one of the recorded authorized representatives of the facility and an authorized security code must accompany the order.
 - Letter of Authorization must contain the same shipping address that appears on the customer's purchase order.
 - Letter of Authorization will not be kept on file at factory.
 - Without the proper security code, Letter of Authorization, or if the shipping address is other than what is listed on the System Information Document, the order cannot be processed.

The System Administrator may elect not to use security codes as part of the authorization process by selecting the "Opt Out" option.

- If the "Opt Out" option IS selected
 - If the shipping address is other than the one listed on the System Information Document, a Letter of Authorization signed by one of the facility's authorized representatives.
 - Letter of Authorization must be signed by one of the facility's authorized representatives.
 - Letter of Authorization must contain the same shipping address that appears on the customer's purchase order.
 - Letter of Authorization will not be kept on file at factory.

System Information Document



System: _____AP _____AS / AHS

NOTE: System Information Document required for all new systems; see reverse for additional document requirements.

Facility Name: _____ Facility Name: _____

Mailing Address: _____ Shipping Address: _____

City: _____ State: _____ City: _____ State: _____

Zip Code: _____ Zip Code: _____

Phone: (_____) _____

Fax: (_____) _____

E-Mail: _____

By: _____
 (Print Name, Primary Systems Administrator) (Title) (Authorized Signatures)

I understand that if any of the authorized representatives of this Facility (as set out below) are removed from their duties for any reason whatsoever, it is my responsibility to notify Corbin Russwin Key Systems Administration, in writing, of their release and the names of their replacements.

Date: _____

Authorized Facility Representatives (Printed Name)	(Title)	(Authorized Signatures)
_____	_____	_____
_____	_____	_____
_____	_____	_____

Please attach any additional.

_____ ((Signature or Initial by System Administrator Only))

"OPT-OUT" Option (System Type AS & AHS Only): By selecting this option I elect not to use the randomized security codes and agree to substitute them with a Letter of Authorization.

ASSA ABLOY is the global leader in door opening solutions, dedicated to satisfying end-user needs for security, safety and convenience



ASSA ABLOY

In U.S.

Corbin Russwin
Architectural Hardware
225 Episcopal Road
Berlin, CT 06037
Phone: 800-543-3658
Fax: 800-447-6714
corbinrusswin.com

In Canada

ASSA ABLOY Door
Security Solutions Canada
160 Four Valley Drive
Vaughan, Ontario
Canada L4K 4T9
Phone: 800-461-3007
Fax: 905-738-2478
www.assaabloy.ca

For more information regarding Corbin Russwin Locksets, Exit Devices, Door Controls and Key Systems, contact your authorized Corbin Russwin Distributor or Sales Representative.