



**Corbin  
Russwin**  
**ASSA ABLOY**

## Price List

Price Book #30

Effective September 1, 2017

ASSA ABLOY, the global leader in door opening solutions

**SECTION** **PAGES**

Service Center Business Hours, Holiday Schedule	1
Order Forms	2
Key System Information Request Form	6
Keyed Order Lead Sheet	7
Tools and Rules	10
Terms and Conditions	14
Warranty	18
Finishes, Samples, Templates	20

**MUSEO®**

TL3700 Series: Museo Levers & Inspire Trim	21
TL3700 Series: Museo Levers & Roses	22
TL3700 Series: Options	26
ML2000 Series: Museo Levers & Inspire Trim	27
ML2000 Series: Museo Levers, Roses & Thumbturns	28
ML2000 Series: Museo Levers & Escutcheons	33
ML20900 Series & ML20600 NAC Series: Museo Levers, Escutcheons, Roses and Thumbturns	38
ML20800 AC2 Series: Museo Levers	50
ED5000 AC2 Series: Museo Levers	53
ED4000 Series: Museo Levers with 800 Series Escutcheon	56
ED5000 Series: Museo Levers with 900 Series Escutcheon	58

**KEY SYSTEMS**

General Information	61
Policy	64
Construction Core	65
Keying, Stamping, Cut Keys	66
Bitting List	67
Key Wizard	68
Key Blanks	69
Access 3 AP Security Cylinders	71
Pyramid Cylinders	77
Conventional Cylinders	83
Interchangeable Core Cylinders	91
Security Cylinders	95
Master Ring Cylinders	101
Service Equipment	104

**ACCESS CONTROL**

Access 800® AC2	105
ML20800 Series	106
CL33800 Series	110
ED5000 x 9800 AC2 Series	114
WM800 Reader/Controller	120
Wiring Diagram Services and Accessories	121

**MORTISE LOCKSETS AND TRIM**

ML2000 Series	123
Vineyard™ Collection	133
Vandal Resistant Trim	135
ML20900 Series & ML20600 NAC Series	136
Cylinder and Keying Options	148
Miscellaneous Options	151

**SPECIALTY HARDWARE**

MicroShield® How to Order	153
BHSS Trim	154
BLSS Trim	155
HSS Trim	156
HPSK Trim	157
HP3000 Series Tubular Lock with Push/Pull Trim	158

CYLINDRICAL LOCKS		PAGES
MicroShield® How to Order		160
CL3100 Series Grade 1 Vandal Resistant Cylindrical Lever Locksets		161
CL3300 Series Grade 1 Extra Heavy-Duty Cylindrical Lever Locksets		167
CL3500 Series Grade 1 Heavy-Duty Cylindrical Lever Locksets		173
CL3800 Series Grade 2 Standard-Duty Lever Locksets		179
CK4300 Series Grade 1 Heavy-Duty Cylindrical Knob Locksets		183
CK4400 Series Grade 2 Standard-Duty Cylindrical Knob Locksets		186
PRE-ASSEMBLED UNIT LOCKSETS		
UT5200 Series		189
AUXILIARY HARDWARE		
PL5000 Series Padlocks		195
DL2200 Series Cylindrical Deadlocks		197
DL3000 Series Cylindrical Deadlocks		200
DL3200 Series Cylindrical Deadlocks		203
DL4100 Series Mortise Deadlocks		206
MULTI-POINT LOCKS		
FE5400S		209
FE6600		225
FE6700		237
MP9800		241
EXIT DEVICES		
MicroShield® Technology		253
ED3000 Crossbar Series		255
ED4000 Narrow Stile Pushpad Series		267
ED5000 Pushpad Series		279
ED7000 Narrow Stile Crossbar Series		302
ED8000 Pushpad Series		313
DOOR CLOSERS		
DC3000 Series		323
DC5000 Series (Cam Action Door Closer)		325
DC6000 Series		327
DC8000 Series		331
DC46900 Series (Safeguard™)		336
DC62900 Series		337
PARTS		
<b>Key Systems</b>		
Plugs and Shells		340
Cylinder Parts		341 - 342
Standard Diameter Cylinder Collars		343
Master Ring Cylinder Collars		344
Tools		344
<b>Mortise Locksets and Trim</b>		
ML2000 and ML2000HS Series – Mortise Locks		345 - 347
ML2000 and ML2000HS Series – Mortise Trim		348 - 356
<b>Vandal Resistant Cylindrical Lever Locksets</b>		
CL3100 Series		357 - 359
<b>Extra Heavy-Duty Cylindrical Lever Locksets</b>		
CL3300 Series		360 - 362
<b>Heavy-Duty Cylindrical Lever Locksets</b>		
CL3500 Series		363 - 364
<b>Grade 2 Key-In-Lever</b>		
CL3700 Series		364
CL3800 Series		365 - 366

Continued on next page.

PARTS	PAGE
-------	------

**Heavy-Duty Cylindrical Knob Locksets**

CK4200 Series	367
CK4300 Series	367

**Standard-Duty Cylindrical Knob Locksets**

CK4400 Series	368
CK4700 Series	368

**Pre-Assembled Unit Locksets**

UT5200 Series	369 - 370
---------------	-----------

**Padlocks, Deadlocks and Push-Pull Latches**

Padlocks	370
DL3000 Series Deadlocks	370

**ED4000 and ED5000 Series**

Device Parts	371 - 373
Trim Parts	373 - 375

**Crossbar Exit Devices and Trims**

ED7000 Series	376 - 381
---------------	-----------

**Pushpad Exit Devices and Trims**

ED8000 Series	382 - 383
---------------	-----------

**Door Closers**

DC3000 Series	384
DC5000 Series	384
DC6000 Series	385
DC8000 Series	386

**Electronic Hardware Parts**

DC46900 Series	387
DC62900 Series	387
Access 800® AC2 Series	387

**Part Number Index**

**388 - 399**

**Service Center Business Hours**

**ASSA ABLOY Door Security Solutions®**

**Customer Service – Monroe** .....8:00 a.m. – 4:30 p.m. (Eastern)

1902 Airport Road

Monroe, NC 28110

Telephone Number: .....(800) 438-1951

Fax Number: .....(800) 338-0965

**Technical Product Support** .....8:00 a.m. - 4:30 p.m. (Eastern)

225 Episcopal Road

Berlin, CT 06037

Telephone Number: .....(888) 607-5703

**Electrified Technical Product Support** .....8:00 a.m. - 4:30 p.m. (Eastern)

Telephone Number: .....(800) 810-WIRE (9473)

Fax Number: .....(203) 603-5981

**Holiday Schedule\***

These following entities will be CLOSED on these dates:

**ASSA ABLOY Door Security Solutions® Customer Service – Monroe**

**Technical Product Support**

**Electrified Technical Product Support- New Haven CT**

September 4, 2017

November 23, 2017

November 24, 2017

December 25, 2017

December 26, 2017

December 27, 2017

December 28, 2017

December 29, 2017

September 4, 2017

November 23, 2017

November 24, 2017

December 25, 2017

December 26, 2017

December 27, 2017

December 28, 2017

December 29, 2017

September 4, 2017

November 23, 2017

November 24, 2017

December 25, 2017

December 26, 2017

\* Dates subject to change.



ASSA ABLOY



ASSA ABLOY

<b>CUSTOMER ACCOUNT #</b>		<b>PLEASE CHECK</b> <input type="checkbox"/> PART SHIP <input type="checkbox"/> SHIP COMPLETE				<b>DATE REQUESTED</b>		<b>SOLD TO ADDRESS</b>	
<b>CUSTOMER P.O. #</b>		<b>P.O. DATE</b>		<b>CONTACT PERSON</b> PHONE # _____ FAX # _____		<b>SHIP TO ADDRESS</b>			
<b>SHIP VIA</b>		<b>MARKS</b> If markings are required, purchase order will be entered to the factory. See <i>Stock Condensed Order Form</i> to include appropriate information.				<b>BUYING PROGRAM</b> <input type="checkbox"/>		<b>OR</b> <input type="checkbox"/> <b>CPQ NUMBER</b> _____	
<b>QTY</b> <i>Required</i>	<b>PART #</b> <i>Required</i>	<b>CYLINDER</b> <i>(2000X033)</i>	<b>KEY</b> <b>BLANKS</b> <i>(6 pin-10)</i>	<b>SERIES &amp;</b> <b>FUNCTION</b> <i>Required</i>	<b>TRIM, DR</b> <b>WIDTH &amp;</b> <b>HEIGHT</b>	<b>HAND</b> <i>R, L, RR, LR</i>	<b>FINISH</b> <i>Required</i>	<b>KEYWAY/</b> <b>SECTION</b>	<b>QUICK CODE</b> <i>M52, M54, M55, M94, KR</i> <i>Electrified Locks</i> <i>(Requires Voltage)</i>



**ASSA ABLOY**

# Stock - Condensed Order Form

Sheet \_\_\_\_\_ of \_\_\_\_\_

This Sheet Only

<b>Customer Name</b>				<b>Purchase Order No.</b>	
<b>Qty.</b>	<b>Series and Function</b>	<b>Trim</b>	<b>Keyway</b>	<b>Finish</b>	<b>Quick Code Options</b>

**Special Notes:**

<b>Item</b>	<b>Qty.</b>	<b>Key Symbol</b>	<b>Hand</b>				<b>Door Number (Up to 10 characters)</b>	<b>Heading (Up to 10 characters)</b>
			<b>RH</b>	<b>LH</b>	<b>RHR</b>	<b>LHR</b>		



**ASSA ABLOY**

**Keyed Order - Condensed Form  
(Cylinders Ordered Separately)**

Sheet \_\_\_\_\_ of \_\_\_\_\_  
 This Sheet Only

<b>Customer Name</b>				<b>Purchase Order No.</b>		
<b>Qty.</b>	<b>Cylinder</b>	<b>Length</b>	<b>Pins</b>	<b>Keyway</b>	<b>Cam/Tailpiece</b>	<b>Finish</b>

**Special Notes:**

<b>Item</b>	<b>Qty.</b>	<b>Key Symbol</b>	<b>Door Number (Up to 10 characters)</b>	<b>Heading (Up to 10 characters)</b>	<b>Keyed Function Used</b>



Sheet \_\_\_\_\_ of \_\_\_\_\_

This Sheet Only

<b>Customer Name</b>				<b>Purchase Order No.</b>	
<b>Qty.</b>	<b>Series and Function</b>	<b>Trim</b>	<b>Keyway</b>	<b>Finish</b>	<b>Quick Code Options</b>

**Special Notes:**

Item	Qty.	Key Symbol	Hand				Door Number (Up to 10 characters)	Heading (Up to 10 characters)
			RH	LH	RHR	LHR		



ASSA ABLOY

Key Systems Information Request Form  
Please fax to Key Systems Admin. @ 800-338-0965



ASSA ABLOY

Date: \_\_\_\_\_

**KEY SYSTEMS INFORMATION**

\*Registry Number: \_\_\_\_\_

\*Job Name and Location: \_\_\_\_\_

\*Keyway: \_\_\_\_\_ Top Master Key Bitting: \_\_\_\_\_

Any Other Known System Information:

Empty rectangular box for system information.

Information Requested:

Empty rectangular box for information requested.

Requested By: \_\_\_\_\_

Phone: \_\_\_\_\_ Fax: \_\_\_\_\_ Email: \_\_\_\_\_

Agency/Distributor Name: \_\_\_\_\_

Key System Administration Response:

Empty rectangular box for key system administration response.

**Please attach a Letter of Authorization from the end user if requesting bitting information.**

**\*Required Information**

Sheet 1 of _____
Date: _____
Purchase Order No.: _____
Date Required: _____

**SOLD TO:**

\_\_\_\_\_

\_\_\_\_\_

\_\_\_\_\_

**SHIP TO:**

\_\_\_\_\_

\_\_\_\_\_

\_\_\_\_\_

**1. JOB NAME AND ADDRESS**

\_\_\_\_\_

\_\_\_\_\_

\_\_\_\_\_

**2. SYSTEM STATUS**

New  Existing ..... Registry No. \_\_\_\_\_

Customer Bittings (Please attach and indicate How to Read)  Bow to Tip  Tip to Bow

Corbin Russwin Factory Order No. \_\_\_\_\_ Authorized Security Code\* \_\_\_\_\_

\* Not required if opt-out has been recorded on SID

**3. HIGHEST LEVEL OF SYSTEM**

1 - SKD  2 - MK  3 - GM  4 - GGM  5 - GGGM

**4. SYSTEM TYPE**

Security  IC  Master Ring  Conventional  Pyramid\*\*  Access 3 - AP\*\*  Access 3 - AS\*\*  Access 3 - AHS\*\*

Other \_\_\_\_\_

\*\*Required documentation must accompany each initial Pyramid or Access 3 order to avoid delay.

**5. KEYS**

**Keyway Selection:**  Stock-L4  Standard  Restricted\*  Patented\* Protected

Specific Keyway \_\_\_\_\_

**Number of Pins:**  5  6 (Default)  7

\* Requires PRIOR Key Systems Approval

**Depth System:**  System 70 (Default)  Pre-System 70  Access 3-AP  Access 3-AS/AHS

**Key Bow Style:** \_\_\_\_\_

**Pyramid & Access 3 have dedicated Bows:** \_\_\_\_\_

**Key Stamping:**

<input type="checkbox"/> VKC0 - No Bitting or Key Set Stamping on Keys	<input type="checkbox"/> Bittings (Standard for Conventional Change Keys)
<input type="checkbox"/> VKC1 - Visual Key Control Keys Only	<input type="checkbox"/> DO NOT DUPLICATE
<input type="checkbox"/> VKC2 - Visual Key Control Keys and Cylinders	<input type="checkbox"/> US PROPERTY DO NOT DUPLICATE
<input type="checkbox"/> VKC3 - Visual Key Control Cylinders Only	<input type="checkbox"/> Special Stamping: _____
<input type="checkbox"/> CKC2 - Concealed Key Control Cylinders and VKC Keys	_____
<input type="checkbox"/> CKC3 - Concealed Key Control Cylinders Only	_____

**6. KEY QUANTITY**

Master Level	Qty.	Special Function	Qty.
<input type="checkbox"/> GGGM _____	_____	<input type="checkbox"/> Control .....	_____
<input type="checkbox"/> GGM _____	_____	<input type="checkbox"/> CMK .....	_____
<input type="checkbox"/> GM _____	_____	<input type="checkbox"/> CMK Control .....	_____
<input type="checkbox"/> _____	_____	<input type="checkbox"/> Emergency .....	_____
<input type="checkbox"/> _____	_____	<input type="checkbox"/> SKD Control .....	_____
<input type="checkbox"/> MK / Group _____	_____	<input type="checkbox"/> SKD CMK .....	_____
<input type="checkbox"/> _____	_____	<input type="checkbox"/> SKD CMK Control .....	_____
<input type="checkbox"/> _____	_____	<input type="checkbox"/> Blockout .....	_____
<input type="checkbox"/> Other _____	_____	<input type="checkbox"/> Maintenance .....	_____
<input type="checkbox"/> _____	_____	<input type="checkbox"/> Housekeeping .....	_____
<input type="checkbox"/> _____	_____	<input type="checkbox"/> Mechanical .....	_____
<input type="checkbox"/> _____	_____	<input type="checkbox"/> Engineering .....	_____
<input type="checkbox"/> _____	_____	<input type="checkbox"/> Janitorial .....	_____
<input type="checkbox"/> _____	_____	<input type="checkbox"/> Other .....	_____

<b>Change Keys*</b>	<b>Qty.</b>
Per cylinder _____	
Per keyed alike group _____	
Per keyed different cylinder _____	

\*Two cut change keys are standard per lockset/cylinder, keyblanks cannot be substituted for cut keys.

**7. CROSS KEYING**

Key Symbol:	To Be Operated By (OBY):

Sheet 2 of _____
Date: _____
Purchase Order No.: _____
Date Required: _____

**SOLD TO:**

\_\_\_\_\_

\_\_\_\_\_

\_\_\_\_\_

**8. CONSTRUCTION MASTER KEYING\***

\*This section Does NOT Refer To Temporary Construction Cores  
 This Order:    Yes             No         Establish for future use only

Ship Construction Keys To: \_\_\_\_\_

Attention: \_\_\_\_\_

**9. PRICING**

Order subject to follow pricing:

- |  |                         |                                      |
|--|-------------------------|--------------------------------------|
| <input type="checkbox"/> Price List Dated _____  | <b>Discounts Quoted</b> | Exit Devices _____                   |
| <input type="checkbox"/> Special Job Quote _____ | Cylindrical Locks _____ | Door Closers _____                   |
| Date Quoted _____                                | Mortise Locks _____     | Electrical Options _____             |
| Quote No. _____                                  | Deadlocks _____         | <input type="checkbox"/> Other _____ |
|  | Cylinders Only _____    | Other _____                          |

**10. PACKAGING AND MARKING**

- Pack change keys with locks (Standard)
- Pack change keys separately (Security, Pyramid and CMK jobs always)
- Label Boxes:     Key symbol     Door No.     Heading

Ship Change Keys To: \_\_\_\_\_

Attention: \_\_\_\_\_

**11. SHIPPING INSTRUCTIONS FOR MASTER KEYS**

Ship Master Keys To: \_\_\_\_\_

Attention: \_\_\_\_\_

**12. BITTING LIST**

Provide Bitting List for This Order:     Yes     No  
 Letter of Authorization:  Attached

Mail Bitting List To: \_\_\_\_\_

Attention: \_\_\_\_\_

**13. CONTACT**

**Name of individual in your organization who is knowledgeable about this project, should any clarification be necessary. (Please print or type.)**

\_\_\_\_\_

Name

\_\_\_\_\_

Phone

\_\_\_\_\_

Fax

This form has been completed by: (please print)

\_\_\_\_\_

Name:

**ADDITIONAL INFORMATION (attach)**

System Expansion Requirements, Special Remarks, etc.

## Ordering Tips

- Please submit **Quick Ship Program Orders** and **Plant Product Orders** on separate order forms.
- Please use **Quick Ship Program Forms** for all **Quick Ship Product Orders** and include **Quick Ship Part Numbers**.
- **Order Forms** are included in the Price Book and at [www.corbinrusswin.com](http://www.corbinrusswin.com).
- We recommend using the **Order Form** included with this Price Book when placing purchase orders for Corbin Russwin products. The **Order Form** is available for copying prior to placing your order.
- Please include **Job Name and Registry Number** for all contract orders.
- Be sure to include **Voltage** on all Electrified Hardware orders.
- A **Letter of Authorization** is required for all Protected and Pyramid Keyways.
- **Keyed Lead Sheets A and B** are *recommended* for contract orders that are keyed to existing Master Key systems.
- Remember to include **Keysets** on all contract orders.
- Be sure to include **Handing** for all unit locks, mortise locks and exit devices.
- If you have a **Quote**, please include it with the purchase order. Orders without this information may be delayed.

## Ordering Tip — Administrative Documentation

When submitting purchase orders to ASSA ABLOY Door Security Solutions® Consultants for processing, please remember that certain cylinder types and/or keyways require additional administrative documentation before the order can be entered.

Purchase orders will be held and questioned if the following keyway/cylinder types do not have the proper administrative documentation submitted with each purchase order:

- Protected and Pyramid keyway products
- Security cylinders and keys
- High security cylinders and keys

All of the above product types must be accompanied by additional administrative documents unless they are shipping direct to the end user facility. These administrative documents include, but may not be limited to, the following:

- Letter of Authorization – must be submitted on the end user facility letterhead, dated and signed by an authorized individual from the facility. Letter must be quantity specific for certain product types. ASSA ABLOY Door Security Solutions Consultants does not keep letters of authorization on file.
- Registration Certificate – only required for Pyramid systems.

## Ordering Checklist

Before placing your order, check for the following:

- ✓ Purchase Order on company letterhead
- ✓ Purchase Order is legible
- ✓ Purchase Order Number
- ✓ Account Number
- ✓ Ship To Address
- ✓ Contact Person for additional information requirements
- ✓ Pricing Requirements – Buying Program or CPQ (please attach)
- ✓ Quick Ship Order (Quick Ship Order Form or Quick Ship part numbers included)
- ✓ Contract Order (Keyed Lead Sheets attached)
- ✓ Handing (if applicable)
- ✓ Design (if applicable)
- ✓ Backset & Strike (if applicable)
- ✓ Finish (if applicable)

## Website

Corbin Russwin's website at [www.corbinrusswin.com](http://www.corbinrusswin.com) is the place to go for all your Corbin Russwin product information needs. Easy-to-navigate menus and intuitive icons allow simple and fast access to the latest on new products, as well as the most up-to-date catalogs, templates and installation instructions.

Another great benefit of the Corbin Russwin website is the ability to become an eBusiness member. Access gives additional information for Corbin Russwin account customers only.

## eBusiness

Visit [www.corbinrusswin.com](http://www.corbinrusswin.com) to sign up for ASSA ABLOY Door Security Solutions eBusiness access.

ASSA ABLOY Door Security Solutions Consultants provides sales, marketing and support for Corbin Russwin.

To sign up for eBusiness, follow the simple instructions listed below. Register today and start enjoying the many benefits!

eBusiness offers anytime access to:

- Order Status
- Stock Status Check
- Key Systems
- Newsletters
- Contact Webmaster
- Fax Order Acknowledgement
- Extended Literature (Price Books, Order Forms, Keyed Lead Sheets)
- Order Check by P.O.
- Cross Reference Guide
- Key Wizard® Order Forms
- ASSA ABLOY Door Security Solutions Online Store
- Fax Program Sign Up
- Fax Invoice

## How to sign up for eBusiness access:

- Step 1: Visit our website at [www.corbinrusswin.com](http://www.corbinrusswin.com)
- Step 2: Double-click eBusiness icon (top right corner)
- Step 3: Complete ASSA ABLOY Door Security Solutions eBusiness sign up form

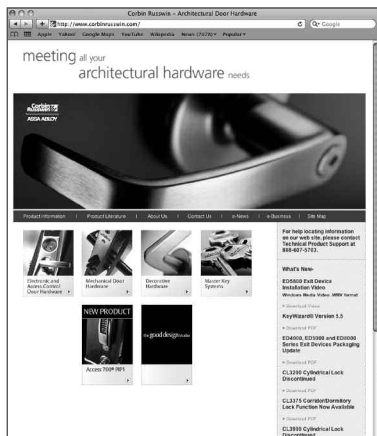



## ONLINE ORDER ENTRY

Would you like to reduce the time to get your orders entered to the factory and eliminate errors associated with manual order entry?

Then try our on-line order entry system. Our convenient web-based order forms can help you submit your orders directly to the factory in minutes.

Contact your customer service representative who will be able to issue your user name and password as well as set up appropriate training sessions for you and your staff.

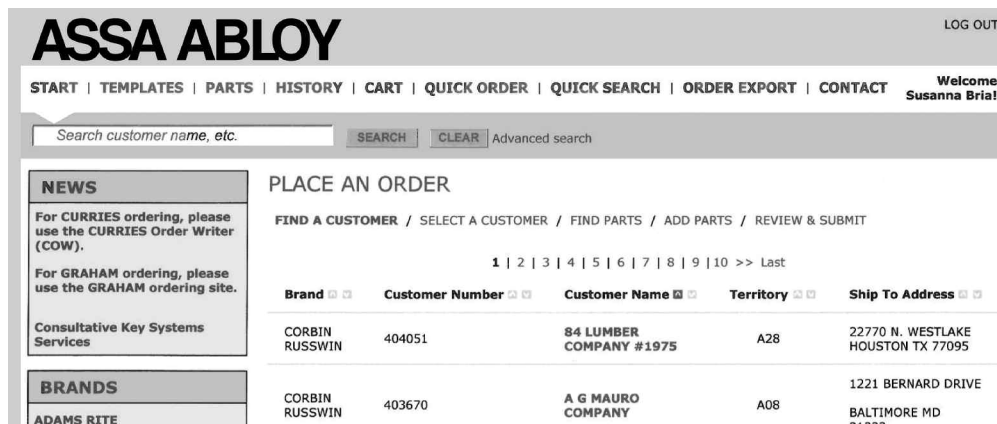

## FAX PROGRAM

Would you like to receive your acknowledgements and invoices, invoices and Return good Authorizations quickly and efficiently?

If so, ASSA ABLOY Door Security Solutions offers the Order Acknowledgement and Invoice, invoices and Return good Authorizations Fax Program. Please see the simple steps below to get signed up today!

Requirement: Valid eBusiness User ID and Password. (If you do not have an eBusiness User ID and Password, please refer to eBusiness Sign Up Section included in this Price Book.)

Step 1: Log into eBusiness.

Step 2: Double-click on "Sign Up for ASSA ABLOY Door Security Solutions's Fax Program Now!"

Step 3: Fill in appropriate information and send.

### Fax Program Signup

If your distributor would like to receive their CORBIN RUSSWIN, NORTON, RIXSON and YALE order acknowledgements, invoices, and return goods authorizations by fax, please complete the form below to sign them up today!

- Yes - Fax Invoices to Fax #:
- Yes - Fax Order Acknowledgements to Fax #:
- Yes - Fax Return Goods Authorizations to Fax #:

Enter the distributor's Account Number in the input box below and click [Add] to add it to your Account Number list. Repeat for each distributor Account Number that you have.

Enter Account Number:

Account Number List:

## Terms and Conditions

### ACCEPTANCE

Corbin Russwin reserves the right to decline an order, in whole or in part, when the type or quantity of goods or credit worthiness of the Purchaser is not satisfactory to us in our sole and absolute discretion.

Purchase Orders, Quote Requests, Acknowledgements or the like issued by the Purchaser that have contrary standard terms and conditions are not binding on Corbin Russwin, unless such terms and conditions are approved in a separate written agreement by Corbin Russwin's authorized representatives. In the event of an acceptance of Purchaser's Purchase Order by Corbin Russwin, the Purchaser agrees that such acceptance is solely conditioned on Purchaser's acceptance of the terms and conditions set forth in this instrument, regardless of the terms and conditions specified in Purchaser's Purchase Order. The terms and conditions in Purchaser's Purchase Order which conflict with the terms and conditions of this instrument shall be disregarded and are hereby rejected, and this instrument shall constitute the entire agreement between Corbin Russwin and the Purchaser.

In the event that Corbin Russwin does not enforce or require strict performance of any term or condition hereof, or of any other document, instrument or other agreement relating to goods sold, such lack of enforcement or requirement of strict performance will not waive, affect or diminish any right of Corbin Russwin to enforce or require strict performance of such term or condition in the future.

### PRICES

All prices are subject to change without notice and are not guaranteed. All shipments will be made at prices in effect at the time of shipment.

Possession of this price list does not constitute an agreement to sell.

We reserve the right to correct clerical, stenographic and other obvious errors at any time.

### TERMS

Invoices dated the 1st through the 15th will be due for 2% discount on the \*10th of the following month. Invoices dated the 16th through the 31st will be due for 2% discount on the \*25th of the following month. \*Net immediately thereafter. (Corbin Russwin retains the right to sell or to decline to sell to any Customer for any reason whatsoever when in its judgment is deemed sufficient.)

It is understood that Corbin Russwin may impose and charge a finance charge which is the lesser of one and one-half percent (1-1/2%) per month or the highest rate allowed by law on any amount which becomes past due and delinquent. Additionally the Customer shall be responsible for all collection costs, court costs and reasonable attorney's fees (where allowed by law) in connection with the recovery of any delinquent amount.

### FREIGHT

All orders are shipped FOB factory/warehouse, except as expressly provided below. When delivered to the Transportation Company, the Purchaser assumes the risk of loss or damage in transit.

Customer orders with net product value in excess of \$12,000.00 will be shipped prepaid by Corbin Russwin's carrier of choice to a single destination point in the United States.

Customer orders with net product value less than \$12,000.00 will be shipped prepaid by Corbin Russwin's carrier of choice and freight and handling charges will be added to the customer's invoice.

A minimum freight and handling charge of \$15.00 will be charged on orders with net product value of \$400.00 or less. The minimum freight and handling charge will not apply to orders for only Cut (bitted) keys of any type, Master Keys, Master keyed cylinders or padlocks and factory generated bitting lists that do not have any other product types included on the order. Freight on these orders will be charged as the percentage of invoice value.

For orders with net product value greater than \$400.00 and less than \$12,000.00, freight charges will be calculated as a percentage of the net invoice value and will be added to Customer's invoice. The percentage is based on the National U.S. Average On Highway Diesel Fuel Prices as reported by the US Department of Energy in effect at the beginning of each quarter. On the first Monday of each quarter, the new rate will be published on the Corbin Russwin and Door Security Solutions extranet and will go into effect on the 2nd Monday of the quarter. Please refer to the extranet for the rate chart and information on the current freight charge percentage. The percentage in effect at the time of shipment of the order will be charged.

Great Grand Master keys, Grand Master keys, Master keys, Construction Master keys, Control Keys, Lot Day Keys which are shipped separate from customer order for security reasons, on orders with total net product value in excess of \$12,000.00 will be shipped prepaid by Corbin Russwin's carrier of choice. If the total order value is less than \$12,000.00, the shipping charges will be added to Customer's invoice.

If a customer provides their own freight account # for the freight charges, Corbin Russwin will apply a handling fee of \$25.00 to the invoice.

Quick Ship Orders – All 1-Week Quick Ship orders are guaranteed to ship from Corbin Russwin 5 working days after receipt of all information necessary to process order or Corbin Russwin will pay freight costs. If Quick Ship is held for credit reasons Corbin Russwin will not be responsible for freight costs.

Expedited shipping options – If the customer requests an expedited method of shipment such as "Next Day Air" the charges will be prepaid by Corbin Russwin and the full rate for the service, as published by the carrier, will be added to the customer's invoice.

### **Terms and Conditions continued**

Packing – Corbin Russwin will pack, mark and ship the products according to its standard procedures for shipment, unless the parties agree, in writing, that Corbin Russwin will comply with any special instructions provided by the customer. Special instructions must be submitted, in writing, at time of order placement. Compliance with special instructions may result in an increased price.

#### **MINIMUM ORDER**

Minimum order value for complete product is \$250.00 net product value. The minimum order value for parts orders is \$100.00 net product value. In the event that the net product value does not meet the required net minimum, Corbin Russwin may, at its sole discretion (a) apply a minimum order charge, (b) reject the order or (c) waive the minimum requirement provided that the waiver of the requirement for one order shall not constitute a waiver of the requirement for any future orders.

The following products are exempt from this policy: Cut (bitted) Keys of any type, Master Keyed Cylinders, Master Keyed Padlocks and Factory Generated Bitting Lists.

#### **QUOTATIONS**

If Corbin Russwin elects to offer a quote, such quote will be valid until the expiration date on that quote. Complete shipment of the order must be accepted by Purchaser within standard manufacturing lead times. The quote number must be referenced on the order. Any invoiced order that has the incorrect discount applied to it and did not have the quote number written on the order will have a service fee of \$100.00 net DEDUCTED from any sales credit issued for the difference in discount. The quote is null and void if the Purchase Order does not include ALL product lines listed on the quote or if the quantities for any item covered by the quote deviate by 10% or more. With the issuance and acceptance of a quote for the purchase of products, the Purchaser agrees that products so purchased will not be resold or transferred to any Distributor not authorized by Corbin Russwin to sell its products. This would be inclusive of branches of the quoted Distributor. Failure to abide by this restriction may result in the Distributor's ineligibility for Quotations, or other actions in Corbin Russwin's discretion. Corbin Russwin and its sales representatives reserve the right, in their sole discretion and for any reason, to refuse a Distributor's request to quote a price other than Corbin Russwin's standard list price and regardless of whether Corbin Russwin or its sales representatives have previously quoted discounted prices to the Distributor on some or all of its orders.

#### **NON-CATALOGED PRODUCTS**

Products not cataloged or listed in this price book will be considered as special products, and will not be manufactured without prior written approval from Corbin Russwin. A minimum special handling charge of \$50.00 will be added for non-cataloged product. Any additional labor or material required will be charged accordingly. Special products require special handling, and therefore standard lead times may not apply. Please consult with your Sales Representative for further details.

#### **CHANGES/CANCELLATION OF ORDERS**

Changes or cancellations to an order will result in a charge of costs for material and labor expenses that have been incurred prior to notification from Customer. If products have already been made and/or are located in the shipping room, the 45% restocking fee will apply. Handling charges are billed on Customer's original order. All Non-Cataloged Goods and Corbin Russwin Quick Ship Orders may not be changed or cancelled.

#### **ADD-ON ORDERS TO QUOTE**

Any new order requesting special pricing to match an existing quote number, which has already been ordered, will be accepted up to sixty (60) days after the acknowledgement of the original order. All add-on orders must reference the original factory order number, and the corresponding quote number to receive the quoted pricing discount. Add-on orders for stock will not be accepted.

#### **PACKAGING**

Many items are defined as to Case Lot Packaging or Minimum Order. The Case Lot policy does not apply to hardware to be used on a specific hardware project.

#### **DELIVERY**

Orders will be acknowledged and given a scheduled delivery date based on estimated manufacturing lead times. Complete information is required to process all orders. Orders with insufficient information for processing (i.e. keying information, door sizes, handing, etc.) may be subject to extended lead times which are relative to the time required in obtaining the necessary information for order processing. Manufacturing lead time will begin once all information is received to process an order. Corbin Russwin will use reasonable efforts to deliver products as estimated, but makes no guarantees as to delivery dates. Corbin Russwin will not be liable for back charges incurred based on availability of product or as a result of delays in delivery caused by insufficient information required to process an order. Corbin Russwin will not be held responsible for delays in delivery caused by strikes, fires, floods or any other causes beyond our control, including the delivery of material to us. Under no circumstances shall Corbin Russwin be liable or accountable for consequential damages due to failure of delivery.

#### **CLAIMS**

In the event of Company or Customer error, claims for shortages, pricing errors and/or incorrectly filled orders must be submitted in writing to Customer Service within thirty (30) days from receipt of material. Any claims for shortages or damage by the Carrier must be made by the Customer directly to the Carrier.

**Terms and Conditions continued****INVOICE DEDUCTION**

A Corbin Russwin Sales Representative or Customer Service Representative must be notified of any disputed invoices within sixty (60) days from the date of invoice. Deductions should only be taken for the disputed amount and the balance of the invoice is due and payable within standard payment terms.

**RETURNED GOODS**

It is the policy of Corbin Russwin to not accept returns of any materials that are correctly furnished as per the Distributor's Purchase Order. Return of product due to customer order error or accommodation must be pre-arranged with Corbin Russwin and approved in writing by Sales Management.

All products returned as "Goodwill" must meet the following criteria to be considered a return:

- Be in original, unmarked and undamaged cartons.
- Be valued in excess of \$250.00 net.
- Shipped and invoiced within the previous one hundred twenty (120) days.
- Custom, non-cataloged goods, master-keyed or Corbin Russwin Quick Ship product is not returnable.

A MINIMUM restocking fee of 45% will be charged. Upon receipt and verification by Corbin Russwin that the returned merchandise meets the foregoing conditions, a credit will be issued for the original invoice amount less the MINIMUM 45% restocking fee.

Defective goods and "Goodwill" products that meet the foregoing criteria may be returned by fulfilling the following conditions:

- Send an RGA request in writing to the Corbin Russwin Sales Representative serving the Purchaser's area.
- Ensure the RGA labels that are sent to Purchaser by Corbin Russwin are visible on return goods shipment.
- Ensure that the RGA number appears on the return shipment label and is legible.
- Return the authorized merchandise within sixty (60) days from the date of RGA issuance date.
- Return shipments must be freight prepaid to the location specified on the RGA.
- Corbin Russwin is not liable for damages to product during shipping.

No credit may be taken or issued prior to RGA approval and receipt of product.

All defective goods within the terms of our limited warranty may be returned for credit or replacement.

**RETURNED GOODS – ELECTROMECHANICAL**

All defective replacement requests for electromechanical products/components must be authorized by contacting the Electromechanical Applications Team at 1-800-810-WIRE to obtain a case number. In order to receive credit for the replacement of an electromechanical product the following criteria needs to be met:

- Defective product return must be under warranty
- Defective product/component return must arrive at factory within 60 days of the Returned Goods Authorization issuance
- Returned product must be found defective or nonfunctional upon test at factory
- Returned product must not have been damaged during installation process

**TAXES**

Prices do not include any present or future Federal, State, or Local property, license, privilege, sales, use, excise, gross receipts or other like taxes or assessments, which may result from transactions or any services performed in connection herewith.

**GOVERNING LAW**

The rights and obligations of the parties shall be governed by the laws of the State of North Carolina, excluding any conflicts of law provisions. The United Nations Convention on Contracts for the International Sale of Goods shall not apply to this Agreement.

**LIMITED WARRANTY**

The Terms and Conditions outlined above are subject to Corbin Russwin's Limited Warranty, which is included in this Price List and incorporated herein by reference.

**PRODUCT MODIFICATIONS**

Corbin Russwin products are not designed or intended for aftermarket modification. The warranty on Corbin Russwin products becomes void if the product is modified in any way, regardless of whether the modification causes or contributes to any alleged defect. Warranty voiding modifications include, but are not limited to, third-party electrification of non-electric products and/or the installation of non-approved or non-Corbin Russwin components.

If a Corbin Russwin product is modified it no longer meets industry certification and quality control standards applicable to the original product and is no longer a genuine Corbin Russwin product. A modified product may not be sold as a Corbin Russwin product and the Corbin Russwin and Design® trademark or certification marks based on the original Corbin Russwin product, such as U.L. or ANSI/BHMA marks, may not appear anywhere on the modified product or on any packaging, literature, or instructions sold with the modified product.

All original Corbin Russwin packaging and literature carries the Corbin Russwin and Design® trademark and must be destroyed if the original Corbin Russwin product is modified. Portions of the product that carry the Corbin Russwin and Design® trademark or certification mark must be discarded and/or replaced by the party making the modification. U.L. and other certification testing and marking are also the responsibility of the party making modification. The use of the Corbin Russwin and Design® trademark on modified products constitutes trademark infringement.

**Terms and Conditions continued****FIRE RATED OPENINGS**

Any retrofit or other field modification to a fire rated opening can potentially impact the fire rating of the opening, and Corbin Russwin, Inc. makes no representations or warranties concerning what such impact may be in any specific situation. When retrofitting any portion of an existing fire-rated opening, or specifying and installing a new fire-rated opening, please consult with a code specialist or local code official (Authority Having Jurisdiction) to ensure compliance with all applicable codes and ratings.

The following policy ("Policy") of ASSA ABLOY Americas ("ASSA ABLOY"), and all of its affiliated group companies (collectively, the "Group Companies"), applies to the use of certain intellectual property of all such Group Companies, including all trademarks, names, logos, product images, and related information (the "ASSA ABLOY Marks"). ASSA ABLOY Marks are proprietary and critical to the success of ASSA ABLOY and the Group Companies, and may only be used in strict compliance with this Policy.

This Policy covers any person or entity reselling any product of any Group Company with the consent of such Group Company (each, an "Approved Reseller"). Each Approved Reseller has a non-exclusive right to use certain of the ASSA ABLOY Marks relating to any of the Group Companies for which it is an Approved Reseller, subject to the following conditions:

- (1) Approved Reseller's use of ASSA ABLOY Marks must be truthful, fair, and not misleading;
- (2) Approved Reseller's advertising must clearly indicate that it is advertising of the Approved Reseller, and is not advertising of ASSA ABLOY;
- (3) Approved Reseller may not use any ASSA ABLOY Marks as part of or in connection with a domain name;
- (4) Approved Reseller's advertising must not imply or suggest an association between the Approved Reseller and ASSA ABLOY other than that of buyer and seller;
- (5) Approved Reseller's use of ASSA ABLOY Marks must be a positive representation of ASSA ABLOY, the Group Companies, and their products;
- (6) Approved Reseller's trade name must be more predominant on Approved Reseller's advertising than the ASSA ABLOY Marks;
- (7) Approved Reseller's use of ASSA ABLOY Marks must include the trademark symbol ® or ™, as appropriate, along with the following trademark legend printed in legible text on the Web page or document containing ASSA ABLOY Marks: "[describe ASSA ABLOY Marks] are trademarks or registered trademarks of ASSA ABLOY, Inc. or one of its affiliates in the United States and other countries.";
- (8) Approved Reseller must not make modifications of any ASSA ABLOY Marks; and
- (9) Approved Reseller may use only ASSA ABLOY Marks associated with the Group Companies for which it is an Approved Reseller (e.g., an Approved Reseller that sells Group Company X products but not Group Company Y products may use Group Company X trademarks in connection with its sale of Group Company X products, but may not use Group Company Y trademarks).

ASSA ABLOY reserves the right to review Approved Reseller's usage of ASSA ABLOY Marks at any time and may:

- (a) require changes to the use of ASSA ABLOY Marks at any time in its sole discretion, which changes must be implemented within 30 days of written notice to Approved Reseller;
- (b) condition the use of ASSA ABLOY Marks on ASSA ABLOY's prior approval of such use, which approval may be withheld in its sole discretion;
- (c) revoke permission to use ASSA ABLOY Marks at any time for any or no reason upon 30 days prior written notice to Approved Reseller; and
- (d) revoke permission to use ASSA ABLOY Marks immediately upon notice to Approved Reseller in the event Approved Reseller is in violation of this Policy, or of any other agreement with ASSA ABLOY or any Group Company.

Approved Reseller's right to use ASSA ABLOY Marks in no way conveys to Approved Reseller any proprietary or economic interest in any ASSA ABLOY Marks.

Use of ASSA ABLOY Marks in violation of this Policy may result in severe civil and criminal liabilities. ASSA ABLOY will vigorously enforce this Policy by seeking all appropriate legal remedies, including, but not limited to, pecuniary damages and injunctive relief.

If there are any questions on this policy, please contact Linda Dean at [ldean@assaabloyusa.com](mailto:ldean@assaabloyusa.com) or 203-498-5596.

**TECHNICAL INFORMATION AND ADVICE**

(a) All designs, data, and specifications provided by Company are proprietary and will not be disclosed or reused by Customer without the prior written consent of Company; (b) Company assumes no obligation or liability for any advice given by Company, the results obtained, or damages incurred, and all such advice is given and accepted at Customer's risk.

**Limited Warranty**

Corbin Russwin, Inc. (Company) warrants that its products sold under the Corbin Russwin and Design® trade name in the United States of America are free from defects in workmanship and materials under normal use and service. This warranty does not cover defects or damage arising from improper installation, lack of or improper maintenance, improper storage, shipping and handling, corrosion, erosion, ordinary wear and tear, misuse, abuse, accident, unauthorized service, or use with unauthorized non-Corbin Russwin products or parts. This warranty is void if any modification is made to the warranty product, regardless of whether the modification causes or contributes to the alleged defect. All modifications are made at the risk of the party making the modification.

The only liability of the Company in tort or contract whether under this warranty or otherwise shall be limited to the repair or replacement of any product or component part which shall prove defective as covered by this warranty, within the stated time frame listed below, after delivery to the original purchaser.

Access 3 Cylinders	.1 year
Pyramid Cylinders	.5 years
CL3100 Series Cylindrical Locksets	.10 years
CL3300 Series Cylindrical Locksets	.7 years
CL3500 Series Cylindrical Locksets	.7 years
CL3800 Series Cylindrical Locksets	.5 years
CK4300 Series Cylindrical Locksets	.3 years
ML2000 Series Mortise Locksets	.10 years
Electrified Locksets	.2 years
ED3000, ED7000, ED8000 Series Exit Devices & Trim	.1 year
ED4000, ED5000 Series Exit Devices & 900 Series Trim	.5 years
All Other Exit Device Trim	.1 year
Electrified Exit Devices	.2 years
FE5400S	.7 years
FE6700	.7 years
FE6800	.7 years
Access 800® CL33800 x TCAC2 Cylindrical	.7 years (mechanical), 2 years (electrical)
Access 800® ML20800 x TCAC2 Mortise Locks	.10 years (mechanical), 2 years (electrical)
Access 800® ED5000 x 9800 x TCAC2 Exit Devices	.5 years (mechanical), 2 years (electrical)
DC3000 Series Closers	.15 years
DC5000 Series Closers	.10 years
DC6000 Series Closers	.25 years
DC8000 Series Closers	.25 years
All Other Corbin Russwin Products	.1 year
MicroShield® Finish	.1 year

**Finishes:**

Corbin Russwin finishes are covered by a limited warranty period of one year after invoice date.

**Warranty Requirements for Cylinders Factory or Field Combined:**

Cylinders are lubricated at the factory with a petroleum based lubricant (Medeco KeyLube). Cylinders should be lubricated periodically depending upon environmental conditions. Petroleum based lubricant is recommended. Never mix petroleum based lubricants with dry lubricants. Corbin Russwin cylinder and/or core warranty will be voided if used in non-Corbin Russwin locking devices.

**Warranty Requirements for Cylinders Field Combined:**

1. Keys shall be cut to the Corbin Russwin key biting specifications required for the particular keyway and depth system.
2. All pin lengths shall be selected according to prevailing factory standards.
3. Original Corbin Russwin cylinders and cylinder components, including pin tumblers and key blanks, shall be used. We reserve the right to void the warranty if we deem that a malfunction is a result of non-original components which do not conform to Corbin Russwin standards.

**Keying Systems:**

All bittings shall be originated or authorized by the Corbin Russwin Key Systems Department to be compatible with one another in a specific type of cylinder (Pyramid, conventional, security, master ring, interchangeable core) and within a particular keying system.

All components of electromagnetic products are covered by a limited warranty period of one year after invoice date thereof of the original purchaser from us. Product repair or replacement, or associated charges, will not be accepted under this warranty unless prior authorization from Corbin Russwin has been given. Upon receipt of products returned for repair or replacement, we will determine whether products qualify for repair or replacement under this warranty. If they do not, we will obtain authorization prior to proceeding.

We have no liability to pay any costs of repair performed by anyone other than qualified personnel authorized by Corbin Russwin prior to the work being done.

**Terms and Conditions continued**

The Company will not pay for the cost of repair performed other than in accordance with this warranty. Written notice of a product or component part believed to be defective as covered by this warranty should be sent to Corbin Russwin, Inc. 225 Episcopal Road, Berlin, CT 06037, and should include your name and address, an identification of the product or component part and a brief description of the defect. Upon receipt of such notice, the Company will inform you where to ship such product or component part, shipping charges prepaid, for examination and, in the event such examination reveals defect covered by this warranty, the product will be repaired or replaced. The Company reserves the right to replace discontinued product with an equivalent product as deemed by the Company.

THIS WARRANTY IS IN LIEU OF ALL OTHER EXPRESS WARRANTIES. TO THE EXTENT PERMITTED BY LAW, ALL IMPLIED WARRANTIES ARE LIMITED TO THE DURATION OF THIS WARRANTY. CORBIN RUSSWIN, INC. SHALL NOT BE LIABLE FOR ANY INCIDENTAL OR CONSEQUENTIAL DAMAGES. NO AGENT, SALES REPRESENTATIVE OR DEALER HAS THE AUTHORITY TO INCREASE OR ALTER THE OBLIGATIONS OF THIS WARRANTY. SOME STATES DO NOT ALLOW LIMITATIONS ON HOW LONG AN IMPLIED WARRANTY LASTS OR THE EXCLUSION OR LIMITATION OF INCIDENTAL OR CONSEQUENTIAL DAMAGES, SO THE ABOVE LIMITATION OR EXCLUSIONS MAY NOT APPLY TO YOU. THIS WARRANTY GIVES YOU SPECIFIC LEGAL RIGHTS, AND YOU MAY ALSO HAVE OTHER RIGHTS WHICH VARY FROM STATE TO STATE.

## Finishes

ANSI/BHMA Designation	Finish/Description
600	Primed for Painting (USP)
605	Bright Brass (US3)
606	Satin Brass (US4)
611	Bright Bronze (US9)
612	Satin Bronze (US10)
613	Dark Oxidized Satin Bronze, Oil Rubbed (US10B)
613E	Dark Oxidized Satin Bronze - Equivalent
613L	Dark Oxidized Satin Bronze, Clear Coated
618	Bright Nickel Plated (US14)
619	Satin Nickel Plated (US15)
622	Flat Black Coated (US19)
625	Bright Chromium Plated (US26)
626	Satin Chromium Plated (US26D)
628	Satin Aluminum, Clear Anodized (808 Mullion)
629*	Bright Stainless Steel (US32)
630*	Satin Stainless Steel (US32D)
689	Silver Aluminum Painted (SBL)
690	Dark Bronze Painted (LBL)
691	Light Bronze Painted (DBL)
693	Black Painted (FBL)
695	Dark Bronze Painted or Anodized (808 Mullion)
696	Satin Brass Painted (GBL)
722	Black oxidized bronze, oil rubbed

\*629 and 630 finish options are Not available for the following Muséo levers: 101, 104, 105, 111, 112, 113, 114, 115, 116, 117, 119, 121, 122, 126, 127, 130, 131, 132

## Samples

Display Mounts (Base Hardware not included). Price covers mount only.

For Product Series	Specify	Price
CL3100, CK4400	SM-CL-NTB	\$178.00
CL3300, CL3500, CL3800	SM-CL-TB	\$178.00
ML2000 x Sectional Trim (Lever, Knob, BLSS, HSS, HPSK)	SM-ML-L	\$166.00
ML2000 x BHSS trim	SM-ML-WAVE-CYL x TP	\$260.00
ML2000 x Roseless	SM-ML-RL	\$178.00
UT5200	SM-UT	\$178.00
HP3000	SM-CL-HP3000	\$217.00
Access 800® CL33800	SM-CL-A800	\$205.00
Access 800® ML20800	SM-ML-A800	\$286.00
Access 800® ED5000 x 9800	SM-ED-A800	\$310.00

Pyramid Sample Display Case

Specify	Price
PS-20-DC	\$310.00

Finish folder with cylinder scalps.

Specify	Price
FP	\$160.00

## Corbin Russwin Templates

Templates of Corbin Russwin products that are most commonly used are available through our website <http://www.corbinrusswin.com/en/site/corbin-russwin/Library/Product-Templates/>



# Tubular Locksets

TL3700 Series: Muséo Levers and Inspire™ Roseless Trim

# MUSÉO®

contemporary trim to complement the interior design of your next project

## GEORGIA



## PABLO



## JACKSON<sup>1</sup>



## SALVADOR



## MARC<sup>1</sup>



J Collar

<sup>1</sup>Handed: specify hand when ordering  
<sup>2</sup>Contact factory for current lead time

613E Dark Oxidized Satin Bronze - Equivalent  
 626 Satin Chromium Plated

605 Bright Brass, Clear Coated  
 606 Satin Brass, Clear Coated  
 611 Bright Bronze, Clear Coated  
 612 Satin Bronze, Clear Coated  
 613 Dark Oxidized Satin Bronze, Oil Rubbed  
 613L Dark Oxidized Satin Bronze, Clear Coated  
 618 Bright Nickel Plated  
 619 Satin Nickel Plated  
 625 Bright Chromium Plated  
 629\* Bright Stainless Steel  
 630\* Satin Stainless Steel  
 722 Black Oxidized Bronze, Oil Rubbed

### Function

TL3710	Passage Set	\$236.00	\$246.00
TL3710A	Passage Set-3 Hour	\$242.00	\$252.00
TL3720	Privacy Set	\$248.00	\$258.00
TL3720A	Privacy Set-3 Hour	\$254.00	\$264.00
TL3750	Single Lever Pull-Through Bolted	\$104.00	\$109.00
TL3770	Double Lever Pull	\$195.00	\$205.00
TL3780	Communicating Set	\$236.00	\$246.00
TL3780A	Communicating Set-3 Hour	\$242.00	\$252.00

Ordering Example Details →

TL3710 Passage: Non-Keyed tubular lock  
 102J Georgia Family Lever, J Collar  
 626 Satin Chrome Finish  
 LH Left Handed

Trim Only				
Quantity	Series/Function	Trim	Finish	Hand
24	TL3710	102J	626	LH

\*629 and \*630 finish options are Not available for all Muséo levers. Please refer to page 20 for availability.

contemporary trim to complement the interior design of your next project

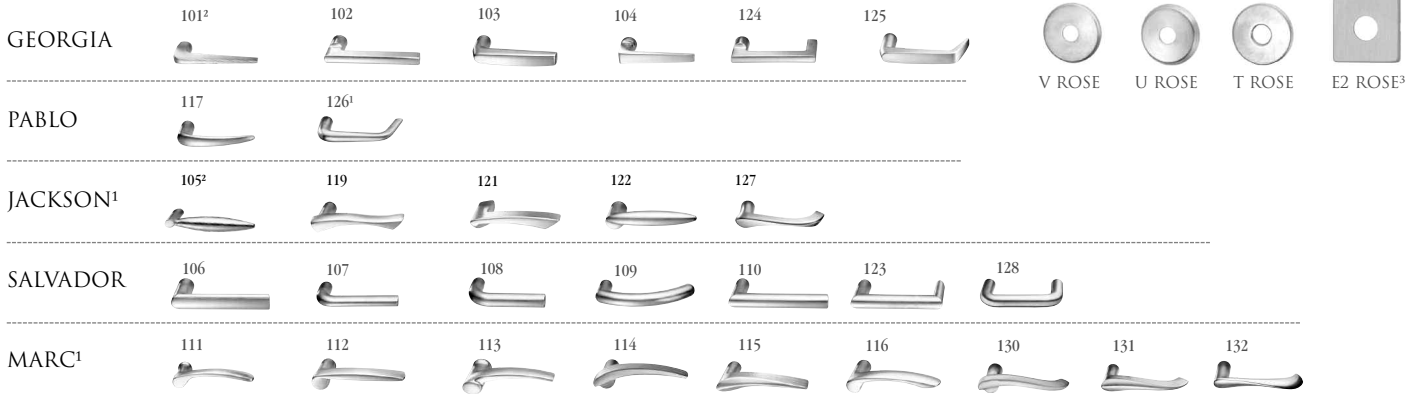

<sup>1</sup>Handed: specify hand when ordering

<sup>2</sup>Contact factory for current lead time

<sup>3</sup>**CAUTION:** Cannot retrofit on existing cylindrical lock door preps with through-bolt holes outside the 2-1/8" bored hole (Ex. CL3300 & CL3500).

613E	Dark Oxidized Satin Bronze - Equivalent
626	Satin Chromium Plated

605	Bright Brass, Clear Coated
606	Satin Brass, Clear Coated
611	Bright Bronze, Clear Coated
612	Satin Bronze, Clear Coated
613	Dark Oxidized Satin Bronze, Oil Rubbed
613L	Dark Oxidized Satin Bronze, Clear Coated
618	Bright Nickel Plated
619	Satin Nickel Plated
625	Bright Chromium Plated
629*	Bright Stainless Steel
630*	Satin Stainless Steel
722	Black Oxidized Bronze, Oil Rubbed

**Function**

TL3710	Passage Set	\$220.00	\$230.00
TL3710A	Passage Set-3 Hour	\$226.00	\$236.00
TL3720	Privacy Set	\$232.00	\$242.00
TL3720A	Privacy Set-3 Hour	\$238.00	\$248.00
TL3750	Single Lever Pull-Through Bolted	\$127.00	\$132.00
TL3750S	Single Lever Pull-Surface Mounted	\$97.00	\$107.00
TL3770	Double Lever Pull	\$184.00	\$194.00
TL3780	Communicating Set	\$220.00	\$230.00
TL3780A	Communicating Set-3 Hour	\$226.00	\$236.00

Ordering Example Details →

TL3710 Passage: Non-Keyed tubular lock  
 111T Marc Lever, T-Rose  
 626 Satin Chrome Finish  
 LH Left Handed

Trim Only				
Quantity	Series/Function	Trim	Finish	Hand
24	TL3710	111T	626	LH

\*629 and \*630 finish options are Not available for all Muséo levers. Please refer to page 20 for availability.

# Tubular Locksets

TL3700 Series: Muséo Levers and Roses



contemporary levers to complement the interior design of your next project

JOSEF

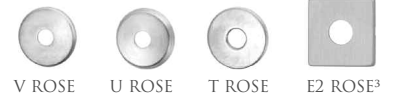

<sup>1</sup>Handed: specify hand when ordering

<sup>2</sup>Contact factory for current lead time

<sup>3</sup>**CAUTION:** Cannot retrofit on existing cylindrical lock door preps with through-bolt holes outside the 2-1/8" bored hole (Ex. CL3300 & CL3500).

613E Dark Oxidized Satin Bronze - Equivalent  
626 Satin Chromium Plated

605 Bright Brass, Clear Coated  
606 Satin Brass, Clear Coated  
611 Bright Bronze, Clear Coated  
612 Satin Bronze, Clear Coated  
613 Dark Oxidized Satin Bronze, Oil Rubbed  
613L Dark Oxidized Satin Bronze, Clear Coated  
618 Bright Nickel Plated  
619 Satin Nickel Plated  
625 Bright Chromium Plated  
629 Bright Stainless Steel  
630 Satin Stainless Steel  
722 Black Oxidized Bronze, Oil Rubbed

## Function

TL3710	Passage Set	\$230.00	\$240.00
TL3710A	Passage Set-3 Hour	\$236.00	\$246.00
TL3720	Privacy Set	\$244.00	\$254.00
TL3720A	Privacy Set-3 Hour	\$250.00	\$260.00
TL3750	Single Lever Pull-Through Bolted	\$130.00	\$140.00
TL3750S	Single Lever Pull-Surface Mounted	\$100.00	\$110.00
TL3770	Double Lever Pull	\$194.00	\$204.00
TL3780	Communicating Set	\$230.00	\$240.00
TL3780A	Communicating Set-3 Hour	\$236.00	\$246.00

Ordering Example Details →

TL3710 Passage: Non-Keyed tubular lock  
133E2 Josef Lever, E2 Rose  
626 Satin Chrome Finish  
LH Left Handed

Trim Only				
Quantity	Series/Function	Trim	Finish	Hand
24	TL3710	133E2	626	LH



Corbin Russwin Architectural Hardware | 225 Episcopal Road | Berlin, CT 06037  
Phone 800-543-3658 | Fax 800-447-6714 | corbinrusswinMUSEO.com

ASSA ABLOY, the global leader in door opening solutions

Price List. 23

September 1, 2017

contemporary levers to complement the interior design of your next project

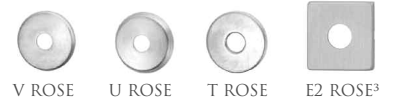
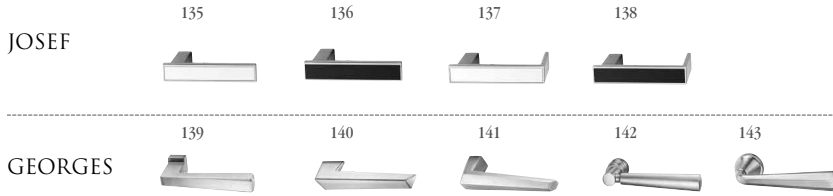

<sup>1</sup>Handed: specify hand when ordering  
<sup>2</sup>Contact factory for current lead time  
<sup>3</sup>**CAUTION:** Cannot retrofit on existing cylindrical lock door preps with through-bolt holes outside the 2-1/8" bored hole (Ex. CL3300 & CL3500).

613E	Dark Oxidized Satin Bronze - Equivalent	605	Bright Brass, Clear Coated
626	Satin Chromium Plated	606	Satin Brass, Clear Coated
		611	Bright Bronze, Clear Coated
		612	Satin Bronze, Clear Coated
		613	Dark Oxidized Satin Bronze, Oil Rubbed
		613L	Dark Oxidized Satin Bronze, Clear Coated
		618	Bright Nickel Plated
		619	Satin Nickel Plated
		625	Bright Chromium Plated
		629	Bright Stainless Steel
		630	Satin Stainless Steel
		722	Black Oxidized Bronze, Oil Rubbed

**Function**

TL3710	Passage Set	\$305.00	\$315.00
TL3710A	Passage Set-3 Hour	\$311.00	\$321.00
TL3720	Privacy Set	\$317.00	\$327.00
TL3720A	Privacy Set-3 Hour	\$323.00	\$333.00
TL3750	Single Lever Pull-Through Bolted	\$205.00	\$215.00
TL3750S	Single Lever Pull-Surface Mounted	\$175.00	\$185.00
TL3770	Double Lever Pull	\$268.00	\$278.00
TL3780	Communicating Set	\$305.00	\$315.00
TL3780A	Communicating Set-3 Hour	\$311.00	\$321.00

Ordering Example Details →

TL3710 Passage: Non-Keyed tubular lock  
 135E2 Josef Lever, E2 Rose  
 626 Satin Chrome Finish  
 LH Left Handed

Trim Only				
Quantity	Series/Function	Trim	Finish	Hand
24	TL3710	135E2	626	LH

# Tubular Locksets

TL3700 Series: Muséo Levers and Roses

# MUSÉO

contemporary trim to complement the interior design of your next project

PIET



629 Bright Stainless Steel  
630 Satin Stainless Steel

### Function

TL3710	Passage Set	240.00
TL3710A	Passage Set - 3 Hour	246.00
TL3720	Privacy Set	254.00
TL3720A	Privacy Set - 3 Hour	260.00
TL3750	Single Lever Pull - Through Bolted	140.00
TL3750S	Single Lever Pull - Surface Mounted	110.00
TL3770	Double Lever Pull	204.00
TL3780	Communicating Set	240.00
TL3780A	Communicating Set - 3 Hour	246.00

PIET



629 Bright Stainless Steel  
630 Satin Stainless Steel

### Function

TL3710	Passage Set	297.00
TL3710A	Passage Set - 3 Hour	303.00
TL3720	Privacy Set	308.00
TL3720A	Privacy Set - 3 Hour	314.00
TL3750	Single Lever Pull - Through Bolted	195.00
TL3750S	Single Lever Pull - Surface Mounted	165.00
TL3770	Double Lever Pull	260.00
TL3780	Communicating Set	297.00
TL3780A	Communicating Set - 3 Hour	303.00

PIET



629 Bright Stainless Steel  
630 Satin Stainless Steel

### Function

TL3710	Passage Set	315.00
TL3710A	Passage Set - 3 Hour	321.00
TL3720	Privacy Set	327.00
TL3720A	Privacy Set - 3 Hour	333.00
TL3750	Single Lever Pull - Through Bolted	215.00
TL3750S	Single Lever Pull - Surface Mounted	185.00
TL3770	Double Lever Pull	278.00
TL3780	Communicating Set	315.00
TL3780A	Communicating Set - 3 Hour	321.00

### Ordering Example Details

TL3710 Passage: Non-Keyed tubular lock  
21WU Piet Family Lever - Wood Insert, U-Rose  
29BH29 Lever Finish  
Wood insert with polished  
stainless steel (629) shank and  
polished stainless steel (629) grip  
629 Lock Finish  
LH Left Handed

### Stock Order

Quantity	Series/ Function	Trim	Lever Finish	Lock Finish	Hand
2	TL3710	21WU	29BH29	629	LH

**CAUTION:** Cannot retrofit on existing cylindrical lock door preps with through-bolt holes outside the 2-1/8" bored hole (Ex. CL3300 & CL3500).



Corbin Russwin Architectural Hardware | 225 Episcopal Road | Berlin, CT 06037  
Phone 800-543-3658 | Fax 800-447-6714 | corbinrusswinMUSEO.com

ASSA ABLOY, the global leader in door opening solutions

Price List. 25

September 1, 2017

contemporary trim to complement the interior design of your next project

### Door Thickness Options

Description	Specify Quick Code	Add or Deduct
1-3/8" (35mm) up to 1-3/4" (44mm)	D138	No Charge
1-3/4" (44mm) up to 2-1/4" (57mm)	(standard)	
2-1/4" (57mm) up to 2-1/2" (64mm)	D214	
(Consult factory if over 2-1/2" (64mm))		

### Backset Options

Description	Specify Quick Code	Add or Deduct
2-3/4"	(standard)	No Charge
2-3/8" <sup>1</sup>	B238	

### Strike Options

Lip Length	ANSI Curved Lip - Specify Quick Code	Curved Lip Box - Specify Quick Code	Full Lip Specify Quick Code	Full Lip Radius Corner Specify Quick Code	Add or Deduct
1"	SA100	SC100			No Charge
1-1/8"	SA118	SC118			
1-1/4"	SA114	(standard)	SF114	SFR114	
1-3/8"	SA138	SC138			
1-1/2"	SA112	SC112 <sup>2</sup>			
1-3/4"	SA134	SC134			Add \$16.00 per lockset
2"	SA200	SC200			
2-1/4"	SA214	SC214			
2-1/2"	SA212	SC212			
2-3/4"	SA234	SC234			
3"	SA300	SC300			

### Miscellaneous Options

Description	Specify Quick Code	Add or Deduct
Latch front, rounded corners	M13	Add \$2.50 per latch
1" (25mm) latch front, square corners <sup>3</sup>	M14	Add \$6.00 per lockset
1" (25mm) latch front, rounded corners	M15	Add \$2.50 per latch
ANSI wrought strike box	M17	Add \$6.00 per lockset

Notes:

1. 1" front supplied standard
2. Standard for D214
3. Standard for 2-3/8" backset

# Mortise Locksets

ML2000 Series: Muséo Levers and Inspire™ Roseless Trim



contemporary trim to complement the interior design of your next project

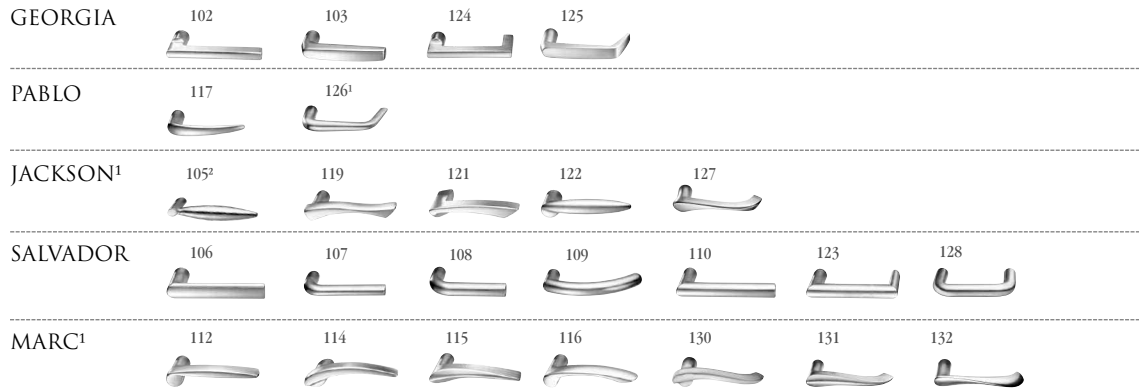

J Collar

<sup>1</sup>Handed: specify hand when ordering.  
<sup>2</sup>Contact factory for current lead time.

\*629 and \*630 finish options are Not available for all Muséo levers.  
 Please refer to page 20 for availability.

613E	Dark Oxidized Satin Bronze - Equivalent	605	Bright Brass, Clear Coated	618	Bright Nickel Plated
626	Satin Chromium Plated	606	Satin Brass, Clear Coated	619	Satin Nickel Plated
		611	Bright Bronze, Clear Coated	625	Bright Chromium Plated
		612	Satin Bronze, Clear Coated	629*	Bright Stainless Steel
		613	Dark Oxidized Satin Bronze, Oil Rubbed	630*	Satin Stainless Steel
		613L	Dark Oxidized Satin Bronze, Clear Coated	722	Black Oxidized Bronze, Oil Rubbed

## Function

Function	Model	Description	Price	Price
Non-Keyed	ML2010	Passage	\$815.00	\$839.00
	ML2020	Privacy		
	ML2030	Privacy	\$924.00	\$948.00
	ML2060	Privacy	\$885.00	\$909.00
	ML2050	Half Dummy	\$320.00	\$332.00
	ML2070	Full Dummy	\$640.00	\$664.00
	ML2080	Half Active Dummy Trim	\$528.00	\$540.00
	ML2090	Full Active Dummy Trim	\$848.00	\$872.00
Single Cylinder	ML2003	Classroom		
	ML2051	Office		
	ML2055	Classroom		
	ML2056	Classroom Holdback	\$971.00	\$995.00
	ML2057	Storeroom		
	ML2069	Institution Privacy		
	ML2053	Entrance		
	ML2054	Entrance	\$984.00	\$1,008.00
ML2058	Entrance Holdback			
Single Cylinder with Deadbolt	ML2024	Entrance		
	ML2048	Entrance		
	ML2059	Security Storeroom		
	ML2065	Dormitory	\$1,007.00	\$1,031.00
	ML2067	Apartment		
	ML2068	Privacy or Classroom		
	ML2073	Classroom Security		
	ML2075	Entrance/Office		
ML2029	Hotel	\$1,062.00	\$1,086.00	
Double Cylinder	ML2002	Classroom Intruder		
	ML2032	Institution		
	ML2042	Entrance	\$1,054.00	\$1,078.00
	ML2052	Classroom Intruder		
	ML2022	Store Door		
	ML2062	Intruder Deadbolt		
	ML2072	Classroom Security Intruder	\$1,090.00	\$1,114.00
	ML2082	Dormitory		
ML2092	Security Institution			
Full Working Trim (Quick Code M31) No cylinder; includes thumbturn lever			\$673.00	\$721.00



### Ordering Example Details

<b>ML2000</b>	ML2051	Office Function
Sectional Trim	102	Georgia Family Lever
(rose)	J	Collar
	625	Finish
	RHR	Handing

### Stock Order

Quantity	Series/Function	Trim	Finish	Hand
24	ML2051	102J	625	RHR



Corbin Russwin Architectural Hardware | 225 Episcopal Road | Berlin, CT 06037  
 Phone 800-543-3658 | Fax 800-447-6714 | corbinrusswinMUSEO.com

ASSA ABLOY, the global leader in door opening solutions

Price List. 27

September 1, 2017

# Mortise Locksets

ML2000 Series: Muséo Levers, Roses and Thumbturns



contemporary levers to complement the interior design of your next project

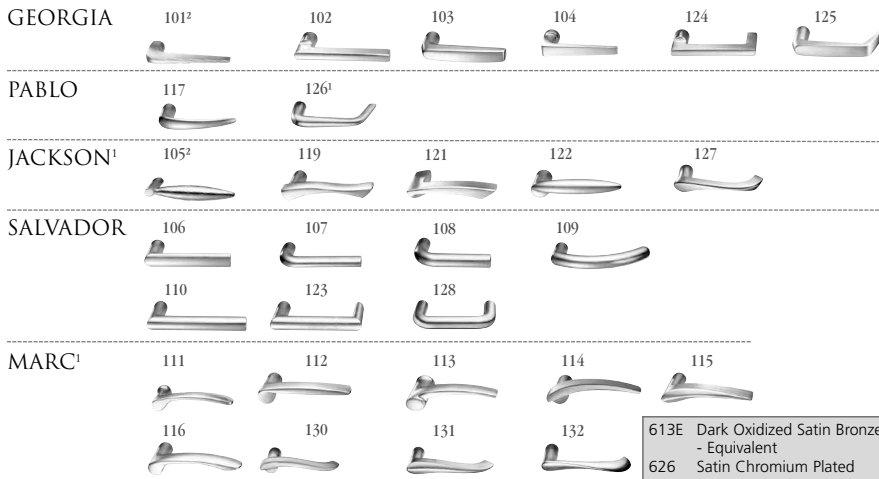

## ROSES

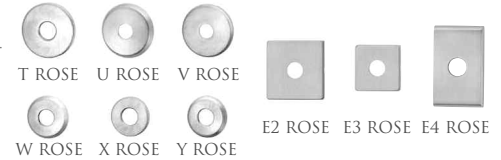

## THUMBTURN<sup>3</sup>



1. Handed: specify hand when ordering
2. Contact factory for current lead time
3. Specify thumbturn as quick code. Thumbturn backplate will match shape of rose chosen (i.e. round or square)

\*629 and \*630 finish options are Not available for all Muséo levers. Please refer to page 20 for availability.

613E	Dark Oxidized Satin Bronze - Equivalent	605	Bright Brass, Clear Coated	618	Bright Nickel Plated
626	Satin Chromium Plated	606	Satin Brass, Clear Coated	619	Satin Nickel Plated
		611	Bright Bronze, Clear Coated	625	Bright Chromium Plated
		612	Satin Bronze, Clear Coated	629*	Bright Stainless Steel
		613	Dark Oxidized Satin Bronze, Oil Rubbed	630*	Satin Stainless Steel
		613L	Dark Oxidized Satin Bronze, Clear Coated	722	Black Oxidized Bronze, Oil Rubbed

## Function

Function	Model	Description	Price	Price
Non-Keyed	ML2010	Passage	\$765.00	\$789.00
	ML2020	Privacy		
	ML2030	Privacy	\$874.00	\$898.00
	ML2060	Privacy	\$840.00	\$864.00
	ML2050	Half Dummy	\$416.00	\$440.00
	ML2070	Full Dummy	\$832.00	\$856.00
	ML2080	Half Active Dummy Trim	\$388.00	\$412.00
	ML2090	Full Active Dummy Trim	\$804.00	\$828.00
Single Cylinder	ML2003	Classroom		
	ML2051	Office		
	ML2055	Classroom		
	ML2056	Classroom Holdback	\$921.00	\$945.00
	ML2057	Storeroom		
	ML2069	Institution Privacy		
Single Cylinder with Deadbolt	ML2053	Entrance		
	ML2054	Entrance	\$934.00	\$958.00
	ML2058	Entrance Holdback		
	ML2024	Entrance		
	ML2048	Entrance		
	ML2059	Security Storeroom		
	ML2065	Dormitory	\$957.00	\$981.00
	ML2067	Apartment		
	ML2068	Privacy or Classroom		
Double Cylinder	ML2073	Classroom Security		
	ML2075	Entrance/Office		
	ML2029	Hotel	\$1,012.00	\$1,036.00
	ML2002	Classroom Intruder		
	ML2032	Institution	\$1,004.00	\$1,028.00
	ML2042	Entrance		
	ML2052	Classroom Intruder		
	ML2022	Store Door		
	ML2062	Intruder Deadbolt		
ML2072	Classroom Security Intruder	\$1,040.00	\$1,064.00	
ML2082	Dormitory			
ML2092	Security Institution			
Full Working Trim (Quick Code M31) No cylinder; includes thumbturn lever			\$735.00	\$759.00



### Ordering Example Details

<b>ML2000</b>	ML2051	Office Function
Sectional Trim (rose)	111	Marc Family Lever
	W	Rose
	625	Finish
	RHR	Handing

### Stock Order

Quantity	Series/Function	Trim	Finish	Hand
24	ML2051	111W	625	RHR

Copyright © 2002 - 2017 Corbin Russwin, Inc.



Corbin Russwin Architectural Hardware | 225 Episcopal Road | Berlin, CT 06037  
Phone 800-543-3658 | Fax 800-447-6714 | corbinrusswinMUSEO.com

ASSA ABLOY, the global leader in door opening solutions

Price List. 28

September 1, 2017



# Mortise Locksets

ML2000 Series: Muséo Levers, Roses and Thumbturns



contemporary levers to complement the interior design of your next project

## JOSEF



## ROSES

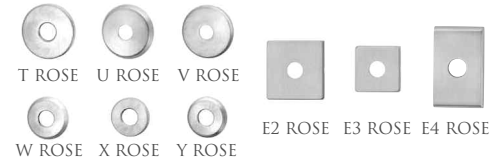

## THUMBTURNS<sup>3</sup>



1. Handed: specify hand when ordering
2. Contact factory for current lead time
3. Specify thumbturn as quick code. Thumbturn backplate will match shape of rose chosen (i.e. round or square)

613E	Dark Oxidized Satin Bronze - Equivalent	605	Bright Brass, Clear Coated	618	Bright Nickel Plated
626	Satin Chromium Plated	606	Satin Brass, Clear Coated	619	Satin Nickel Plated
		611	Bright Bronze, Clear Coated	625	Bright Chromium Plated
		612	Satin Bronze, Clear Coated	629	Bright Stainless Steel
		613	Dark Oxidized Satin Bronze, Oil Rubbed	630	Satin Stainless Steel
		613L	Dark Oxidized Satin Bronze, Clear Coated	722	Black Oxidized Bronze, Oil Rubbed

## Function

Function	Model	Description	Price	Price
Non-Keyed	ML2010	Passage	\$870.00	\$894.00
	ML2020	Privacy		
	ML2030	Privacy	\$935.00	
	ML2060	Privacy	\$901.00	\$959.00
	ML2050	Half Dummy	\$335.00	\$925.00
	ML2070	Full Dummy	\$694.00	\$359.00
	ML2080	Half Active Dummy Trim	\$511.00	\$718.00
	ML2090	Full Active Dummy Trim	\$870.00	\$535.00
Single Cylinder	ML2003	Classroom		
	ML2051	Office		
	ML2055	Classroom		
	ML2056	Classroom Holdback	\$982.00	\$1,006.00
	ML2057	Storeroom		
	ML2069	Institution Privacy		
	ML2053	Entrance		
ML2054	Entrance	\$995.00	\$1,019.00	
ML2058	Entrance Holdback			
Single Cylinder with Deadbolt	ML2024	Entrance		
	ML2048	Entrance		
	ML2059	Security Storeroom		
	ML2065	Dormitory	\$1,018.00	\$1,042.00
	ML2067	Apartment		
	ML2068	Privacy or Classroom		
	ML2073	Classroom Security		
	ML2075	Entrance/Office		
ML2029	Hotel	\$1,073.00	\$1,097.00	
Double Cylinder	ML2002	Classroom Intruder		
	ML2032	Institution		
	ML2042	Entrance	\$1,065.00	\$1,089.00
	ML2052	Classroom Intruder		
	ML2022	Store Door		
	ML2062	Intruder Deadbolt		
	ML2072	Classroom Security Intruder	\$1,101.00	\$1,125.00
	ML2082	Dormitory		
ML2092	Security Institution			
Full Working Trim (Quick Code M31) No cylinder; includes thumbturn lever			\$685.00	\$709.00



### Ordering Example Details

<b>ML2000</b>	ML2051	Office Function
Sectional Trim (rose)	133	Josef Family Lever
	E4	Rose
	625	Finish
	RHR	Handing

### Stock Order

Quantity	Series/Function	Trim	Finish	Hand
24	ML2051	133E4	625	RHR



Corbin Russwin Architectural Hardware | 225 Episcopal Road | Berlin, CT 06037  
Phone 800-543-3658 | Fax 800-447-6714 | corbinrusswinMUSEO.com

ASSA ABLOY, the global leader in door opening solutions

Price List. 29

September 1, 2017

# Mortise Locksets

ML2000 Series: Muséo Levers, Roses and Thumbturns



contemporary levers to complement the interior design of your next project

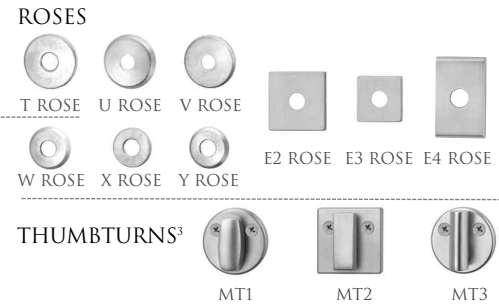
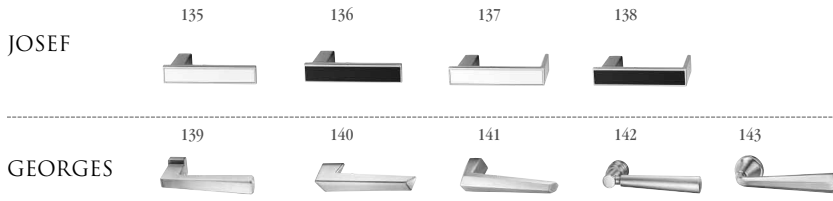

1. Handed: specify hand when ordering
2. Contact factory for current lead time
3. Specify thumbturn as quick code. Thumbturn backplate will match shape of rose chosen (i.e. round or square)

613E	Dark Oxidized Satin Bronze - Equivalent	605	Bright Brass, Clear Coated	618	Bright Nickel Plated
626	Satin Chromium Plated	606	Satin Brass, Clear Coated	619	Satin Nickel Plated
		611	Bright Bronze, Clear Coated	625	Bright Chromium Plated
		612	Satin Bronze, Clear Coated	629	Bright Stainless Steel
		613	Dark Oxidized Satin Bronze, Oil Rubbed	630	Satin Stainless Steel
		613L	Dark Oxidized Satin Bronze, Clear Coated	722	Black Oxidized Bronze, Oil Rubbed

## Function

Function	Model	Description	Price	Price
Non-Keyed	ML2010	Passage	\$942.00	\$966.00
	ML2020	Privacy	\$1,007.00	\$1,031.00
	ML2030	Privacy		
	ML2060	Privacy	\$968.00	\$992.00
	ML2050	Half Dummy	\$365.00	\$389.00
	ML2070	Full Dummy	\$754.00	\$778.00
	ML2080	Half Active Dummy Trim	\$548.00	\$572.00
	ML2090	Full Active Dummy Trim	\$937.00	\$961.00
Single Cylinder	ML2003	Classroom	\$1,054.00	\$1,078.00
	ML2051	Office		
	ML2055	Classroom		
	ML2056	Classroom Holdback		
	ML2057	Storeroom	\$1,067.00	\$1,091.00
	ML2069	Institution Privacy		
Single Cylinder with Deadbolt	ML2053	Entrance	\$1,090.00	\$1,114.00
	ML2054	Entrance		
	ML2058	Entrance Holdback		
	ML2024	Entrance		
	ML2048	Entrance	\$1,145.00	\$1,169.00
	ML2059	Security Storeroom		
	ML2065	Dormitory		
	ML2067	Apartment		
ML2068	Privacy or Classroom	\$1,173.00	\$1,197.00	
ML2073	Classroom Security			
ML2075	Entrance/Office			
ML2029	Hotel			
Double Cylinder	ML2002	Classroom Intruder	\$1,137.00	\$1,161.00
	ML2032	Institution		
	ML2042	Classroom Intruder		
	ML2052	Classroom Intruder		
	ML2022	Store Door	\$1,173.00	\$1,197.00
	ML2062	Intruder Deadbolt		
	ML2072	Classroom Security Intruder		
	ML2082	Dormitory		
ML2092	Security Institution			
Full Working Trim (Quick Code M31) No cylinder; includes thumbturn lever			\$755.00	\$779.00



### Ordering Example Details

<b>ML2000</b>	ML2051	Office Function
Sectional Trim (rose)	135	Josef Family Lever
	E4	Rose
	625	Finish
	RHR	Handing

### Stock Order

Quantity	Series/Function	Trim	Finish	Hand
24	ML2051	135E4	625	RHR

Copyright © 2002 - 2017 Corbin Russwin, Inc.



ASSA ABLOY

Corbin Russwin Architectural Hardware | 225 Episcopal Road | Berlin, CT 06037  
Phone 800-543-3658 | Fax 800-447-6714 | corbinrusswinMUSEO.com

ASSA ABLOY, the global leader in door opening solutions

Price List. 30

September 1, 2017

# Mortise Locksets

ML2000 Series: Muséo Levers, Roses and Thumbturns



contemporary trim to complement the interior design of your next project

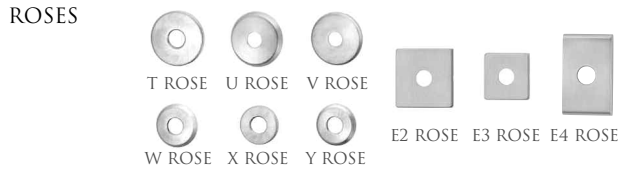

629	Bright Stainless Steel
630	Satin Stainless Steel

Specify thumbturn as quick code. Thumbturn backplate will match shape of rose chosen (i.e. round or square)

### Function

Non-Keypad	ML2010	Passage	\$894.00
	ML2020	Privacy	\$959.00
	ML2030	Privacy	
	ML2060	Privacy	\$925.00
	ML2050	Half Dummy	\$359.00
	ML2070	Full Dummy	\$718.00
	ML2080	Half Active Dummy Trim	\$535.00
	ML2090	Full Active Dummy Trim	\$894.00
Single Cylinder	ML2003	Classroom	\$1,006.00
	ML2051	Office	
	ML2055	Classroom	
	ML2056	Classroom Holdback	
	ML2057	Storeroom	\$1,019.00
	ML2069	Institution Privacy	
	ML2053	Entrance	
	ML2054	Entrance	
Single Cylinder with Deadbolt	ML2024	Entrance	\$1,042.00
	ML2048	Entrance	
	ML2059	Security Storeroom	
	ML2065	Dormitory	
	ML2067	Apartment	
	ML2068	Privacy or Classroom	
	ML2073	Classroom Security	
	ML2075	Entrance/Office	
ML2029	Hotel	\$1,097.00	
Double Cylinder	ML2002	Classroom Intruder	\$1,089.00
	ML2032	Institution	
	ML2042	Entrance	
	ML2052	Classroom Intruder	
	ML2022	Store Door	\$1,125.00
	ML2062	Intruder Deadbolt	
	ML2072	Classroom Security Intruder	
	ML2082	Dormitory	
ML2092	Security Institution		
Full Working Trim (Quick Code M31) No cylinder; includes thumbturn lever			\$709.00



### Ordering Example Details

**ML2000**  
Sectional Trim  
(rose)

ML2051 Office Function  
21M Piet Family Lever - Polished with Satin Insert  
V Rose  
293029 Lever Finish  
Polished with satin stainless steel insert (630),  
polished stainless steel (629) shank and  
polished stainless steel (629) grip  
629 Lock Finish  
RHR Handing

### Stock Order

Quantity	Series/Function	Trim	Lever Finish	Lock Finish	Hand
2	ML2051	21MV	293029	629	RHR



Corbin Russwin Architectural Hardware | 225 Episcopal Road | Berlin, CT 06037  
Phone 800-543-3658 | Fax 800-447-6714 | corbinrusswinMUSEO.com

ASSA ABLOY, the global leader in door opening solutions

Price List. 31

September 1, 2017

# Mortise Locksets

ML2000 Series: Muséo Levers, Roses and Thumbturns



contemporary levers to complement the interior design of your next project

## PIET



## ROSES

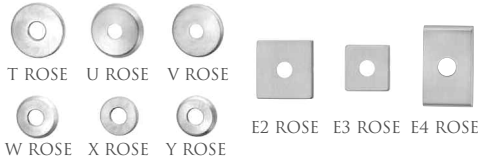

## THUMBTURNS



629	Bright Stainless Steel
630	Satin Stainless Steel

Specify thumbturn as quick code. Thumbturn backplate will match shape of rose chosen (i.e. round or square)

### Function

Function	Model	Description	Price
Non-Keypad	ML2010	Passage	\$966.00
	ML2020	Privacy	\$1,031.00
	ML2030	Privacy	
	ML2060	Privacy	\$992.00
	ML2050	Half Dummy	\$389.00
	ML2070	Full Dummy	\$778.00
	ML2080	Half Active Dummy Trim	\$572.00
	ML2090	Full Active Dummy Trim	\$961.00
Single Cylinder	ML2003	Classroom	\$1,078.00
	ML2051	Office	
	ML2055	Classroom	
	ML2056	Classroom Holdback	
	ML2057	Storeroom	
	ML2069	Institution Privacy	\$1,091.00
	ML2053	Entrance	
	ML2054	Entrance	
Single Cylinder with Deadbolt	ML2024	Entrance	\$1,114.00
	ML2048	Entrance	
	ML2059	Security Storeroom	
	ML2065	Dormitory	
	ML2067	Apartment	
	ML2068	Privacy or Classroom	
	ML2073	Classroom Security	
	ML2075	Entrance/Office	
ML2029	Hotel	\$1,169.00	
Double Cylinder	ML2002	Classroom Intruder	\$1,161.00
	ML2032	Institution	
	ML2042	Entrance	
	ML2052	Classroom Intruder	\$1,197.00
	ML2022	Store Door	
	ML2062	Intruder Deadbolt	
	ML2072	Classroom Security Intruder	
	ML2082	Dormitory	
ML2092	Security Institution		
Full Working Trim (Quick Code M31) No cylinder; includes thumbturn lever			\$779.00



### Ordering Example Details

<b>ML2000</b>	ML2051	Office Function
Sectional Trim (rose)	21W	Piet Family Lever - Wood Insert
	U	Rose
	29BH29	Lever Finish
		Wood insert with polished stainless steel (629) shank and polished stainless steel (629) grip
	629	Lock Finish
	RHR	Handing

### Stock Order

Quantity	Series/Function	Trim	Lever Finish	Lock Finish	Hand
2	ML2051	21WU	29BH29	629	RHR

Copyright © 2002 - 2017 Corbin Russwin, Inc.



Corbin Russwin Architectural Hardware | 225 Episcopal Road | Berlin, CT 06037  
Phone 800-543-3658 | Fax 800-447-6714 | corbinrusswinMUSEO.com

ASSA ABLOY, the global leader in door opening solutions

Price List. 32

September 1, 2017

# Mortise Locksets

ML2000 Series: Muséo Levers and Escutcheons



contemporary levers to complement the interior design of your next project

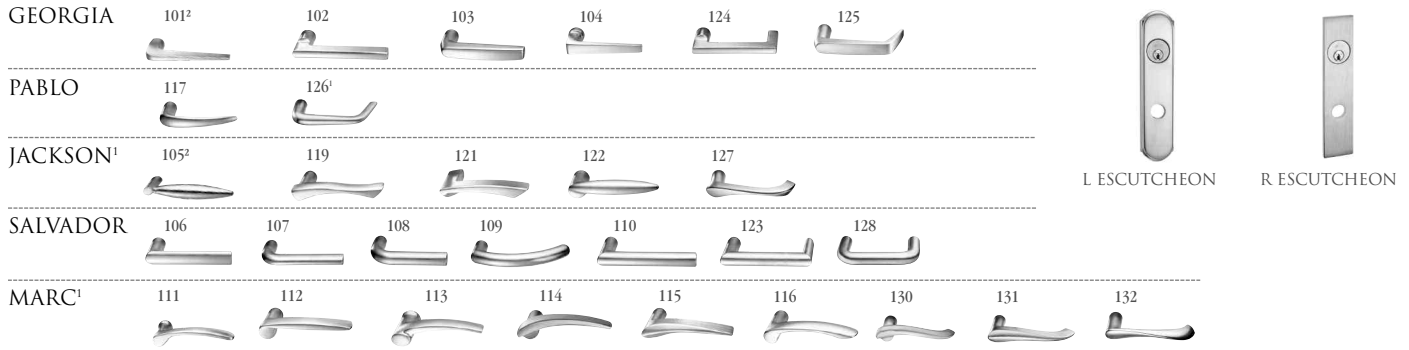

1. Handed: specify hand when ordering.
2. Contact factory for current lead time.

\*629 and \*630 finish options are Not available for all Muséo levers. Please refer to page 20 for availability.

613E	Dark Oxidized Satin Bronze - Equivalent	605	Bright Brass, Clear Coated	618	Bright Nickel Plated
626	Satin Chromium Plated	606	Satin Brass, Clear Coated	619	Satin Nickel Plated
		611	Bright Bronze, Clear Coated	625	Bright Chromium Plated
		612	Satin Bronze, Clear Coated	629*	Bright Stainless Steel
		613	Dark Oxidized Satin Bronze, Oil Rubbed	630*	Satin Stainless Steel
		613L	Dark Oxidized Satin Bronze, Clear Coated	722	Black Oxidized Bronze, Oil Rubbed

### Function

Model	Function	Price	Price
ML2010	Passage	\$819.00	\$843.00
ML2020	Privacy		
ML2030	Privacy	\$928.00	\$952.00
ML2060	Privacy	\$894.00	\$918.00
ML2050	Half Dummy	\$443.00	\$467.00
ML2070	Full Dummy	\$886.00	\$910.00
ML2080	Half Active Dummy Trim	\$415.00	\$439.00
ML2090	Full Active Dummy Trim	\$858.00	\$882.00
ML2003	Classroom		
ML2051	Office		
ML2055	Classroom	\$975.00	\$999.00
ML2056	Classroom Holdback		
ML2057	Storeroom		
ML2069	Institution Privacy		
ML2053	Entrance		
ML2054	Entrance	\$988.00	\$1,012.00
ML2058	Entrance Holdback		
ML2024	Entrance		
ML2048	Entrance		
ML2059	Security Storeroom		
ML2065	Dormitory	\$1,011.00	\$1,035.00
ML2067	Apartment		
ML2068	Privacy or Classroom		
ML2073	Classroom Security		
ML2075	Entrance/Office		
ML2029	Hotel	\$1,066.00	\$1,090.00
ML2002	Classroom Intruder		
ML2032	Institution	\$1,058.00	\$1,082.00
ML2042	Entrance		
ML2052	Classroom Intruder		
ML2022	Store Door		
ML2062	Intruder Deadbolt		
ML2072	Classroom Security Intruder	\$1,094.00	\$1,118.00
ML2082	Dormitory		
ML2092	Security Institution		
Full Working Trim (Quick Code M31) No cylinder; includes thumbturn lever		\$698.00	\$722.00



### Ordering Example Details

<b>ML2000</b>	Office Function
Escutcheon Trim	Marc Family Lever
ML2051	Escutcheon
111	Finish
L	Handing
619	
RHR	

### Stock Order

Quantity	Series/Function	Trim	Finish	Hand
24	ML2051	111L	619	RHR



Corbin Russwin Architectural Hardware | 225 Episcopal Road | Berlin, CT 06037  
Phone 800-543-3658 | Fax 800-447-6714 | corbinrusswinMUSEO.com

ASSA ABLOY, the global leader in door opening solutions

Price List. 33

September 1, 2017

# Mortise Locksets

ML2000 Series: Muséo Levers and Escutcheons

# MUSÉO®

contemporary levers to complement the interior design of your next project

JOSEF



L ESCUTCHEON R ESCUTCHEON

1. Handed: specify hand when ordering
2. Contact factory for current lead time

613E	Dark Oxidized Satin Bronze - Equivalent	605	Bright Brass, Clear Coated	618	Bright Nickel Plated
626	Satin Chromium Plated	606	Satin Brass, Clear Coated	619	Satin Nickel Plated
		611	Bright Bronze, Clear Coated	625	Bright Chromium Plated
		612	Satin Bronze, Clear Coated	629	Bright Stainless Steel
		613	Dark Oxidized Satin Bronze, Oil Rubbed	630	Satin Stainless Steel
		613L	Dark Oxidized Satin Bronze, Clear Coated	722	Black Oxidized Bronze, Oil Rubbed

### Function

Function	Model	Description	Price	Price
Non-Keyed	ML2010	Passage	\$943.00	\$967.00
	ML2020	Privacy		
	ML2030	Privacy	\$1,008.00	\$1,032.00
	ML2060	Privacy	\$974.00	\$998.00
	ML2050	Half Dummy	\$371.50	\$395.50
	ML2070	Full Dummy	\$767.00	\$791.00
	ML2080	Half Active Dummy Trim	\$547.50	\$571.50
	ML2090	Full Active Dummy Trim	\$943.00	\$967.00
Single Cylinder	ML2003	Classroom		
	ML2051	Office		
	ML2055	Classroom	\$1,055.00	\$1,079.00
	ML2056	Classroom Holdback		
	ML2057	Storeroom		
	ML2069	Institution Privacy		
	ML2053	Entrance		
ML2054	Entrance	\$1,068.00	\$1,092.00	
ML2058	Entrance Holdback			
Single Cylinder with Deadbolt	ML2024	Entrance		
	ML2048	Entrance		
	ML2059	Security Storeroom		
	ML2065	Dormitory	\$1,091.00	\$1,115.00
	ML2067	Apartment		
	ML2068	Privacy or Classroom		
	ML2073	Classroom Security		
	ML2075	Entrance/Office		
ML2029	Hotel	\$1,146.00	\$1,170.00	
Double Cylinder	ML2002	Classroom Intruder		
	ML2032	Institution	\$1,138.00	\$1,162.00
	ML2042	Entrance		
	ML2052	Classroom Intruder		
	ML2022	Store Door		
	ML2062	Intruder Deadbolt		
	ML2072	Classroom Security Intruder	\$1,174.00	\$1,198.00
	ML2082	Dormitory		
ML2092	Security Institution			
Full Working Trim (Quick Code M31) No cylinder; includes thumbturn lever			\$758.00	\$782.00



### Ordering Example Details

<b>ML2000</b>	ML2051	Office Function
Escutcheon Trim	133	Josef Family Lever
	L	Escutcheon
	619	Finish
	RHR	Handing

### Stock Order

Quantity	Series/Function	Trim	Finish	Hand
24	ML2051	133L	619	RHR

Copyright © 2002 - 2017 Corbin Russwin, Inc.



ASSA ABLOY

Corbin Russwin Architectural Hardware | 225 Episcopal Road | Berlin, CT 06037  
Phone 800-543-3658 | Fax 800-447-6714 | corbinrusswinMUSEO.com

ASSA ABLOY, the global leader in door opening solutions

Price List. 34

September 1, 2017

contemporary levers to complement the interior design of your next project

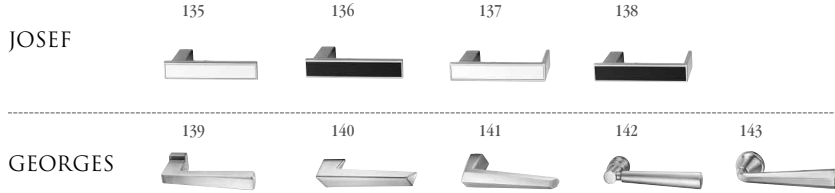

- 1. Handed: specify hand when ordering
- 2. Contact factory for current lead time

613E	Dark Oxidized Satin Bronze - Equivalent	605	Bright Brass, Clear Coated	618	Bright Nickel Plated
626	Satin Chromium Plated	606	Satin Brass, Clear Coated	619	Satin Nickel Plated
		611	Bright Bronze, Clear Coated	625	Bright Chromium Plated
		612	Satin Bronze, Clear Coated	629	Bright Stainless Steel
		613	Dark Oxidized Satin Bronze, Oil Rubbed	630	Satin Stainless Steel
		613L	Dark Oxidized Satin Bronze, Clear Coated	722	Black Oxidized Bronze, Oil Rubbed

**Function**

Function	Model	Description	Price 1	Price 2
Non-Keyed	ML2010	Passage	\$1,015.00	\$1,039.00
	ML2020	Privacy		
	ML2030	Privacy	\$1,080.00	\$1,104.00
	ML2060	Privacy	\$1,041.00	\$1,065.00
	ML2050	Half Dummy	\$401.50	\$425.50
	ML2070	Full Dummy	\$827.00	\$851.00
	ML2080	Half Active Dummy Trim	\$584.50	\$608.50
	ML2090	Full Active Dummy Trim	\$1,010.00	\$1,034.00
Single Cylinder	ML2003	Classroom		
	ML2051	Office		
	ML2055	Classroom	\$1,127.00	\$1,151.00
	ML2056	Classroom Holdback		
	ML2057	Storeroom		
	ML2069	Institution Privacy		
	ML2053	Entrance		
	ML2054	Entrance	\$1,140.00	\$1,164.00
Single Cylinder with Deadbolt	ML2024	Entrance		
	ML2048	Entrance		
	ML2059	Security Storeroom		
	ML2065	Dormitory	\$1,163.00	\$1,187.00
	ML2067	Apartment		
	ML2068	Privacy or Classroom		
	ML2073	Classroom Security		
	ML2075	Entrance/Office		
Double Cylinder	ML2029	Hotel	\$1,218.00	\$1,242.00
	ML2002	Classroom Intruder		
	ML2032	Institution	\$1,210.00	\$1,234.00
	ML2042	Entrance		
	ML2052	Classroom Intruder		
	ML2022	Store Door		
	ML2062	Intruder Deadbolt		
	ML2072	Classroom Security Intruder	\$1,246.00	\$1,270.00
ML2082	Dormitory			
ML2092	Security Institution			
Full Working Trim (Quick Code M31) No cylinder; includes thumbturn lever			\$828.00	\$852.00



Ordering Example Details

<b>ML2000</b>	ML2051	Office Function
Escutcheon Trim	135	Josef Family Lever
	L	Escutcheon
	619	Finish
	RHR	Handing

Stock Order

Quantity	Series/Function	Trim	Finish	Hand
24	ML2051	135L	619	RHR



Corbin Russwin Architectural Hardware | 225 Episcopal Road | Berlin, CT 06037  
Phone 800-543-3658 | Fax 800-447-6714 | corbinrusswinMUSEO.com

ASSA ABLOY, the global leader in door opening solutions

Price List. 35

September 1, 2017

# Mortise Locksets

ML2000 Series: Muséo Levers and Escutcheons

# MUSÉO®

contemporary levers to complement the interior design of your next project

PIET



L ESCUTCHEON

R ESCUTCHEON

629 Bright Stainless Steel  
630 Satin Stainless Steel

## Function

Non-Keypad	ML2010	Passage	\$967.00	
	ML2020	Privacy	\$1,032.00	
	ML2030	Privacy		
	ML2060	Privacy		
	ML2050	Half Dummy		
	ML2070	Full Dummy		
	ML2080	Half Active Dummy Trim		
	ML2090	Full Active Dummy Trim		
Single Cylinder	ML2003	Classroom		\$1,079.00
	ML2051	Office		
	ML2055	Classroom		
	ML2056	Classroom Holdback		
	ML2057	Storeroom		
	ML2069	Institution Privacy		
	ML2053	Entrance	\$1,092.00	
	ML2054	Entrance		
ML2058	Entrance Holdback			
Single Cylinder with Deadbolt	ML2024	Entrance	\$1,115.00	
	ML2048	Entrance		
	ML2059	Security Storeroom		
	ML2065	Dormitory		
	ML2067	Apartment		
	ML2068	Privacy or Classroom		
	ML2073	Classroom Security		
	ML2075	Entrance/Office		
ML2029	Hotel	\$1,170.00		
Double Cylinder	ML2002	Classroom Intruder	\$1,162.00	
	ML2032	Institution		
	ML2042	Entrance		
	ML2052	Classroom Intruder		
	ML2022	Store Door	\$1,198.00	
	ML2062	Intruder Deadbolt		
	ML2072	Classroom Security Intruder		
	ML2082	Dormitory		
ML2092	Security Institution			
Full Working Trim (Quick Code M31) No cylinder; includes thumbturn lever			\$782.00	



Ordering Example Details

**ML2000**  
Escutcheon  
Trim

ML2051 Office Function  
21M Piet Family Lever - Polished with Satin Insert  
L Escutcheon  
293029 Lever Finish  
Polished with satin stainless steel insert (630),  
polished stainless steel (629) shank and  
polished stainless steel (629) grip  
629 Lock Finish  
RHR Handing

## Stock Order

Quantity	Series/Function	Trim	Lever Finish	Lock Finish	Hand
2	ML2051	21ML	293029	629	RHR



**ASSA ABLOY**

Corbin Russwin Architectural Hardware | 225 Episcopal Road | Berlin, CT 06037  
Phone 800-543-3658 | Fax 800-447-6714 | corbinrusswinMUSEO.com

ASSA ABLOY, the global leader in door opening solutions

Price List. 36

September 1, 2017



# Mortise Locksets

ML2000 Series: Muséo Levers and Escutcheons



contemporary levers to complement the interior design of your next project

PIET



629	Bright Stainless Steel
630	Satin Stainless Steel

## Function

Function	Model	Description	Price
Non-Keyed	ML2010	Passage	\$1,039.00
	ML2020	Privacy	\$1,104.00
	ML2030	Privacy	\$1,065.00
	ML2060	Privacy	\$425.50
	ML2050	Half Dummy	\$851.00
	ML2070	Full Dummy	\$608.50
	ML2080	Half Active Dummy Trim	\$1,034.00
Single Cylinder	ML2003	Classroom	\$1,151.00
	ML2051	Office	
	ML2055	Classroom	
	ML2056	Classroom Holdback	
	ML2057	Storeroom	
	ML2069	Institution Privacy	
	ML2053	Entrance	
ML2054	Entrance		
ML2058	Entrance Holdback		
Single Cylinder with Deadbolt	ML2024	Entrance	\$1,187.00
	ML2048	Entrance	
	ML2059	Security Storeroom	
	ML2065	Dormitory	
	ML2067	Apartment	
	ML2068	Privacy or Classroom	
	ML2073	Classroom Security	
	ML2075	Entrance/Office	
ML2029	Hotel	\$1,242.00	
Double Cylinder	ML2002	Classroom Intruder	\$1,234.00
	ML2032	Institution	
	ML2042	Entrance	
	ML2052	Classroom Intruder	
	ML2022	Store Door	\$1,270.00
	ML2062	Intruder Deadbolt	
	ML2072	Classroom Security Intruder	
	ML2082	Dormitory	
ML2092	Security Institution		
Full Working Trim (Quick Code M31) No cylinder; includes thumbturn lever			\$852.00



### Ordering Example Details

<b>ML2000</b>	ML2051	Office Function
Escutcheon	21W	Piet Family Lever - Wood Insert
Trim	L	Escutcheon
	29BH29	Lever Finish
		Wood insert with polished stainless steel (629) shank and polished stainless steel (629) grip
	629	Lock Finish
	RHR	Handing

Stock Order					
Quantity	Series/Function	Trim	Lever Finish	Lock Finish	Hand
2	ML2051	21WL	29BH29	629	RHR



Corbin Russwin Architectural Hardware | 225 Episcopal Road | Berlin, CT 06037  
 Phone 800-543-3658 | Fax 800-447-6714 | corbinrusswinMUSEO.com

ASSA ABLOY, the global leader in door opening solutions

Price List. 37

September 1, 2017

# Mortise Locksets

ML20900 Series Museo Levers and Inspire Roseless Trim

# MUSÉO®

contemporary levers to complement the interior design of your next project

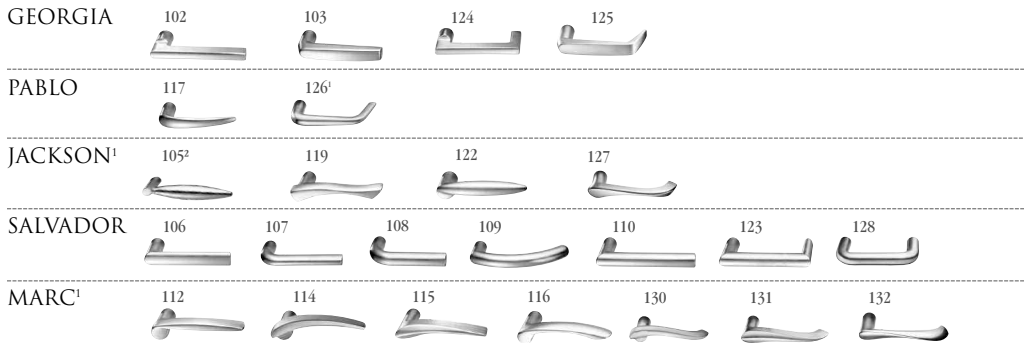

1. Handed: specify hand when ordering
2. Contact factory for current lead time

613E	Dark Oxidized Satin Bronze - Equivalent	605	Bright Brass, Clear Coated	618	Bright Nickel Plated
626	Satin Chromium Plated	606	Satin Brass, Clear Coated	619	Satin Nickel Plated
		611	Bright Bronze, Clear Coated	625	Bright Chromium Plated
		612	Satin Bronze, Clear Coated	629*	Bright Stainless Steel
		613	Dark Oxidized Satin Bronze, Oil Rubbed	630*	Satin Stainless Steel
		613L	Dark Oxidized Satin Bronze, Clear Coated	722	Black Oxidized Bronze, Oil Rubbed

### Function

Lever with Roses					
Single Cylinder	ML20914	Fail Safe	\$1,189.00	\$1,213.00	
	ML20906	Fail Safe Fail Secure Fail Secure			
No Cylinder Override	ML20907	Fail Safe	\$1,106.00	\$1,130.00	
	ML20915	Fail Safe Fail Secure Fail Secure			
Double Cylinder	ML20932	Fail Safe Fail Secure	\$1,272.00	\$1,296.00	



### Ordering Example Details

<b>ML2000</b>	Sectional Trim (rose)	ML2051	Office Function Georgia Family Lever
		J	Collar
		625	Finish
		RHR	Handing

Stock Order				
Quantity	Series/Function	Trim	Finish	Hand
24	ML2051	102J	625	RHR

\*629 and \*630 finish options are Not available for all Muséo levers. Please refer to page 20 for availability.

contemporary levers to complement the interior design of your next project

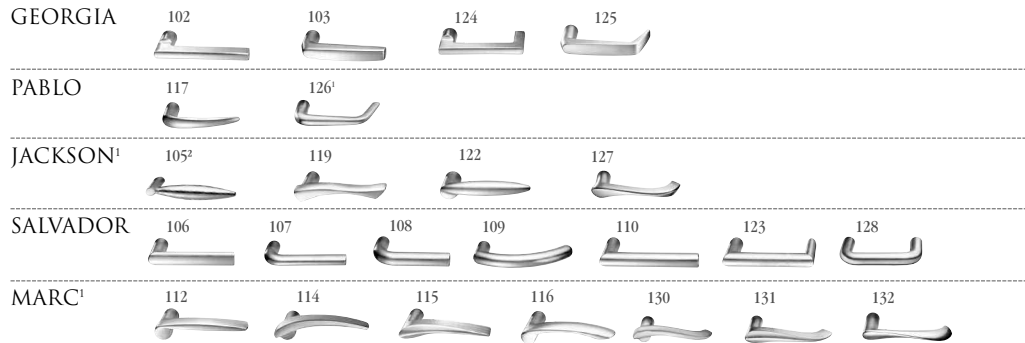

1. Handed: specify hand when ordering
2. Contact factory for current lead time

613E	Dark Oxidized Satin Bronze - Equivalent	605	Bright Brass, Clear Coated	618	Bright Nickel Plated
626	Satin Chromium Plated	606	Satin Brass, Clear Coated	619	Satin Nickel Plated
		611	Bright Bronze, Clear Coated	625	Bright Chromium Plated
		612	Satin Bronze, Clear Coated	629*	Bright Stainless Steel
		613	Dark Oxidized Satin Bronze, Oil Rubbed	630*	Satin Stainless Steel
		613L	Dark Oxidized Satin Bronze, Clear Coated	722	Black Oxidized Bronze, Oil Rubbed

**Function**

Lever with Roses					
Single Cylinder	ML20606 x NAC	Fail Safe/Fail Secure	\$1,364.00		\$1,388.00
	ML20608 x NAC	Fail Safe/Fail Secure	\$1,439.00		\$1,463.00
No Cylinder Override	ML20607 x NAC	Fail Safe/Fail Secure	\$1,281.00		\$1,305.00
	ML20609 x NAC	Fail Safe/Fail Secure	\$1,356.00		\$1,380.00

**ML20600 High Security Monitoring Options**

Description	Specify	Add or Deduct
Mercury and Lenel compatible 1KΩ/2KΩ resistance supervision	R01	Add \$100.00 per lockset
Software House compatible 1KΩ/2KΩ resistance supervision	R03	Add \$100.00 per lockset
AMAG compatible 4-state supervision	R04	Add \$100.00 per lockset
Deadbolt Privacy Function	PHR	Add \$100.00 per lockset
Deadbolt Privacy and Mercury / Lenel 1KΩ/2KΩ	PHRR01	Add \$200.00 per lockset
Deadbolt Privacy and Software House 1KΩ/2KΩ	PHRR03	Add \$200.00 per lockset
Deadbolt Privacy and AMAG 4-State	PHRR04	Add \$200.00 per lockset



Ordering Example Details →

ML2000 Mortise Lock x NAC x No Cylinder x Deadbolt x Fail-Secure

- Muséo® lever 102 with J Collar
- Polished chrome finish
- Right hand reverse
- Deadbolt privacy function, Mercury and Lenel compatible 1KΩ/2KΩ resistance supervision

Stock Order							
Quantity	Series/Function	Technology Code	Trim	Finish	Hand	Fail Safe/Fail Secure	High Security Monitoring Options
24	ML20608	NAC	102J	625	RHR	SEC	PHRR01

\*629 and \*630 finish options are Not available for all Muséo levers. Please refer to page 20 for availability.

# Electrically Controlled Mortise Locksets

ML20900 Series: Muséo Levers, Escutcheons, Roses and Thumbturns



contemporary levers to complement the interior design of your next project

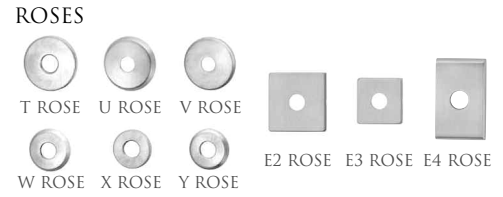
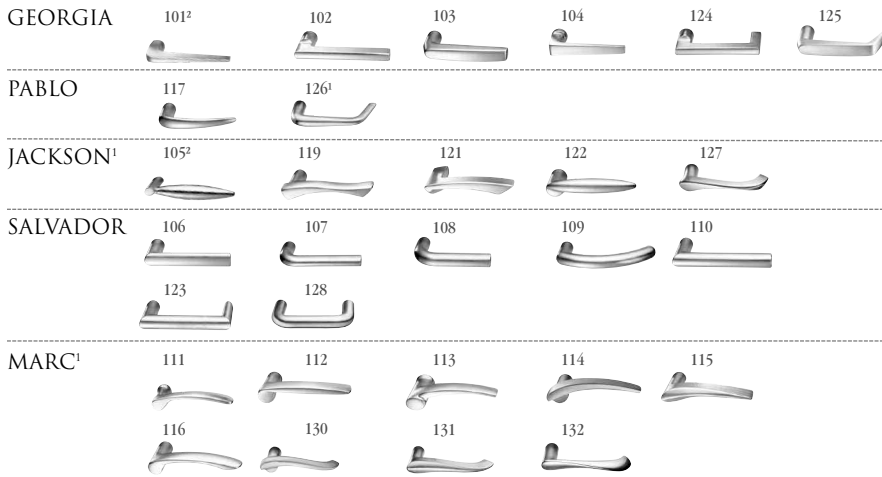

1. Handed: specify hand when ordering
2. Contact factory for current lead time
3. Specify thumbturn as quick code. Thumbturn backplate will match shape of rose chosen (i.e. round or square). Not available with escutcheons.

\*629 and \*630 finish options are Not available for all Muséo levers. Please refer to page 20 for availability.

613E	Dark Oxidized Satin Bronze - Equivalent	605	Bright Brass, Clear Coated	618	Bright Nickel Plated
626	Satin Chromium Plated	606	Satin Brass, Clear Coated	619	Satin Nickel Plated
		611	Bright Bronze, Clear Coated	625	Bright Chromium Plated
		612	Satin Bronze, Clear Coated	629*	Bright Stainless Steel
		613	Dark Oxidized Satin Bronze, Oil Rubbed	630*	Satin Stainless Steel
		613L	Dark Oxidized Satin Bronze, Clear Coated	722	Black Oxidized Bronze, Oil Rubbed

## Function

Lever with Escutcheons: L,R				
Single Cylinder	ML20914	Fail Safe/Fail Secure*	\$1,193.00	\$1,217.00
	ML20906			
No Cylinder Override	ML20907	Fail Safe/Fail Secure*	\$1,110.00	\$1,134.00
	ML20915			
Double Cylinder	ML20932	Fail Safe/Fail Secure*	\$1,276.00	\$1,300.00
Lever with Roses: V,U,T,Y,X,W,E2,E3,E4				
Single Cylinder	ML20914	Fail Safe/Fail Secure*	\$1,139.00	\$1,163.00
	ML20906			
No Cylinder Override	ML20907	Fail Safe/Fail Secure*	\$1,056.00	\$1,080.00
	ML20915			
Double Cylinder	ML20932	Fail Safe/Fail Secure*	\$1,222.00	\$1,246.00

\*Must specify: SAF for Fail Safe or SEC for Fail Secure.



Ordering Example Details  
**ML20900 ECL**  
 Escutcheon Trim  
 ML20914 Single Cylinder  
 SEC Fail Secure  
 104 Salvador Family Lever  
 L Escutcheon  
 613 Finish  
 RHR Handing  
 24 AD 24 Volt AC/DC

Stock Order						
Quantity	Series/Function	Fail Safe/Fail Secure	Trim	Finish	Hand	Voltage
24	ML20914	SEC	104L	613	RHR	24 AD

Copyright © 2002 - 2017 Corbin Russwin, Inc.



Corbin Russwin Architectural Hardware | 225 Episcopal Road | Berlin, CT 06037  
 Phone 800-543-3658 | Fax 800-447-6714 | corbinrusswinMUSEO.com

ASSA ABLOY, the global leader in door opening solutions

Price List. 04

September 1, 2017

contemporary levers to complement the interior design of your next project

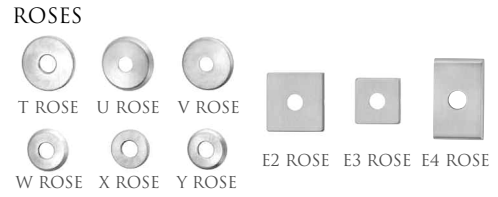
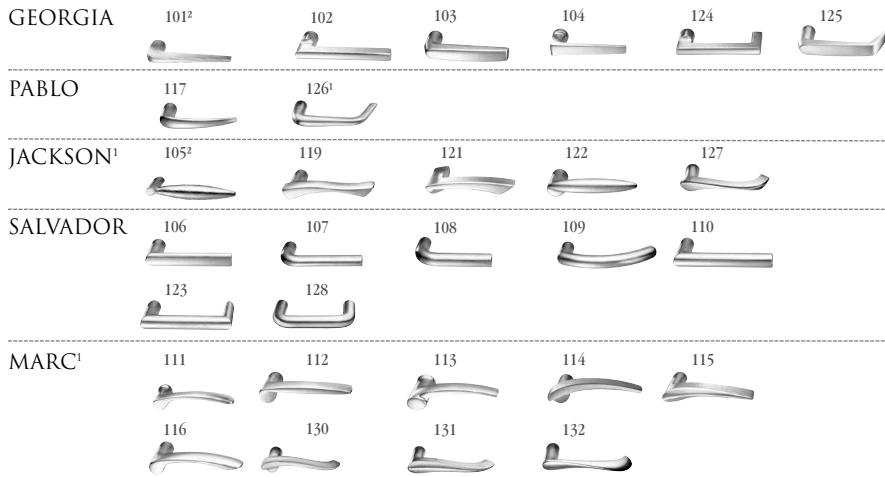

1. Handed: specify hand when ordering
2. Contact factory for current lead time
3. Specify thumbturn as quick code. Thumbturn backplate will match shape of rose chosen (i.e. round or square). Not available with escutcheons.

\*629 and \*630 finish options are Not available for all Muséo levers. Please refer to page 20 for availability.

613E Dark Oxidized Satin Bronze - Equivalent  
 626 Satin Chromium Plated

605 Bright Brass, Clear Coated  
 606 Satin Brass, Clear Coated  
 611 Bright Bronze, Clear Coated  
 612 Satin Bronze, Clear Coated  
 613 Dark Oxidized Satin Bronze, Oil Rubbed  
 613L Dark Oxidized Satin Bronze, Clear Coated  
 618 Bright Nickel Plated  
 619 Satin Nickel Plated  
 625 Bright Chromium Plated  
 629\* Bright Stainless Steel  
 630\* Satin Stainless Steel  
 722 Black Oxidized Bronze, Oil Rubbed

**Function**

Lever with Escutcheons: L,R					
Single Cylinder	ML20606 x NAC	Fail Safe/Fail Secure	\$1,368.00		\$1,392.00
	ML20608 x NAC	Fail Safe/Fail Secure	\$1,443.00		\$1,392.00
No Cylinder Override	ML20607 x NAC	Fail Safe/Fail Secure	\$1,285.00		\$1,309.00
	ML20609 x NAC	Fail Safe/Fail Secure	\$1,360.00		\$1,384.00

Lever with Roses: V,U,T,Y,X,W,E2,E3,E4					
Single Cylinder	ML20606 x NAC	Fail Safe/Fail Secure	\$1,314.00		\$1,338.00
	ML20608 x NAC	Fail Safe/Fail Secure	\$1,389.00		\$1,413.00
No Cylinder Override	ML20607 x NAC	Fail Safe/Fail Secure	\$1,231.00		\$1,255.00
	ML20609 x NAC	Fail Safe/Fail Secure	\$1,306.00		\$1,330.00

\*Must specify: SAF for Fail Safe or SEC for Fail Secure.

**ML20600 High Security Monitoring Options**

Description	Specify	Add or Deduct
Mercury and Lenel compatible 1KΩ/2KΩ resistance supervision	R01	Add \$100.00 per lockset
Software House compatible 1KΩ/2KΩ resistance supervision	R03	Add \$100.00 per lockset
AMAG compatible 4-state supervision	R04	Add \$100.00 per lockset
Deadbolt Privacy Function	PHR	Add \$100.00 per lockset
Deadbolt Privacy and Mercury / Lenel 1KΩ/2KΩ	PHRR01	Add \$200.00 per lockset
Deadbolt Privacy and Software House 1KΩ/2KΩ	PHRR03	Add \$200.00 per lockset
Deadbolt Privacy and AMAG 4-State	PHRR04	Add \$200.00 per lockset



Ordering Example Details

<b>ML20600 NAC</b> Escutcheon Trim	ML20608 Single Cylinder SEC Fail Secure 104 Salvador Family Lever L Escutcheon 613 Finish RHR Handing 24 AD 24 Volt AC/DC
---------------------------------------	---

**Stock Order**

Quantity	Series/Function	Technology Code	Trim	Finish	Hand	Fail Safe/Fail Secure	High Security Monitoring Options
24	ML20608	NAC	104L	613	RHR	SEC	PHRR01



Corbin Russwin Architectural Hardware | 225 Episcopal Road | Berlin, CT 06037  
 Phone 800-543-3658 | Fax 800-447-6714 | corbinrusswinMUSEO.com

ASSA ABLOY, the global leader in door opening solutions

Price List. 41

September 1, 2017

contemporary levers to complement the interior design of your next project

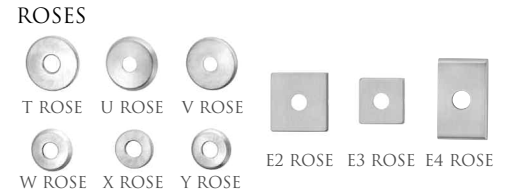

1. Handed: specify hand when ordering
2. Contact factory for current lead time
3. Specify thumbturn as quick code. Thumbturn backplate will match shape of rose chosen (i.e. round or square). Not available with escutcheons.

613E	Dark Oxidized Satin Bronze - Equivalent	605	Bright Brass, Clear Coated	618	Bright Nickel Plated
626	Satin Chromium Plated	606	Satin Brass, Clear Coated	619	Satin Nickel Plated
		611	Bright Bronze, Clear Coated	625	Bright Chromium Plated
		612	Satin Bronze, Clear Coated	629	Bright Stainless Steel
		613	Dark Oxidized Satin Bronze, Oil Rubbed	630	Satin Stainless Steel
		613L	Dark Oxidized Satin Bronze, Clear Coated	722	Black Oxidized Bronze, Oil Rubbed

**Function**

Lever with Escutcheons: L,R					
Single Cylinder	ML20914	Fail Safe/Fail Secure*	\$1,273.00		\$1,297.00
	ML20906				
No Cylinder Override	ML20907	Fail Safe/Fail Secure*	\$1,190.00		\$1,214.00
	ML20915				
Double Cylinder	ML20932	Fail Safe/Fail Secure*	\$1,356.00		\$1,380.00
Lever with Roses: V,U,T,Y,X,W,E2,E3,E4					
Single Cylinder	ML20914	Fail Safe/Fail Secure*	\$1,200.00		\$1,224.00
	ML20906				
No Cylinder Override	ML20907	Fail Safe/Fail Secure*	\$1,117.00		\$1,141.00
	ML20915				
Double Cylinder	ML20932	Fail Safe/Fail Secure*	\$1,283.00		\$1,307.00

\*Must specify: SAF for Fail Safe or SEC for Fail Secure.



Ordering Example Details

**ML20900 ECL**  
Escutcheon Trim

ML20914 Single Cylinder  
SEC Fail Secure  
133 Josef Family Lever  
L Escutcheon  
613 Finish  
RHR Handing  
24 AD 24 Volt AC/DC

**Stock Order**

Quantity	Series/Function	Fail Safe/Fail Secure	Trim	Finish	Hand	Voltage
24	ML20914	SEC	133L	613	RHR	24 AD

contemporary levers to complement the interior design of your next project

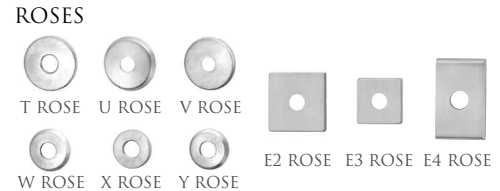

1. Handed: specify hand when ordering
2. Contact factory for current lead time
3. Specify thumbturn as quick code. Thumbturn backplate will match shape of rose chosen (i.e. round or square). Not available with escutcheons.

613E	Dark Oxidized Satin Bronze - Equivalent	605	Bright Brass, Clear Coated	618	Bright Nickel Plated
626	Satin Chromium Plated	606	Satin Brass, Clear Coated	619	Satin Nickel Plated
		611	Bright Bronze, Clear Coated	625	Bright Chromium Plated
		612	Satin Bronze, Clear Coated	629	Bright Stainless Steel
		613	Dark Oxidized Satin Bronze, Oil Rubbed	630	Satin Stainless Steel
		613L	Dark Oxidized Satin Bronze, Clear Coated	722	Black Oxidized Bronze, Oil Rubbed

**Function**

Lever with Escutcheons: L,R					
Single Cylinder	ML20606 x NAC	Fail Safe/Fail Secure	\$1,448.00		\$1,472.00
	ML20608 x NAC	Fail Safe/Fail Secure	\$1,523.00		\$1,547.00
No Cylinder Override	ML20607 x NAC	Fail Safe/Fail Secure	\$1,365.00		\$1,389.00
	ML20609 x NAC	Fail Safe/Fail Secure	\$1,440.00		\$1,464.00

Lever with Roses: V,U,T,Y,X,W,E2,E3,E4					
Single Cylinder	ML20606 x NAC	Fail Safe/Fail Secure	\$1,375.00		\$1,399.00
	ML20608 x NAC	Fail Safe/Fail Secure	\$1,450.00		\$1,474.00
No Cylinder Override	ML20607 x NAC	Fail Safe/Fail Secure	\$1,292.00		\$1,316.00
	ML20609 x NAC	Fail Safe/Fail Secure	\$1,367.00		\$1,391.00

\*Must specify: SAF for Fail Safe or SEC for Fail Secure.

**ML20600 High Security Monitoring Options**

Description	Specify	Add or Deduct
Mercury and Lenel compatible 1KΩ/2KΩ resistance supervision	R01	Add \$100.00 per lockset
Software House compatible 1KΩ/2KΩ resistance supervision	R03	Add \$100.00 per lockset
AMAG compatible 4-state supervision	R04	Add \$100.00 per lockset
Deadbolt Privacy Function	PHR	Add \$100.00 per lockset
Deadbolt Privacy and Mercury / Lenel 1KΩ/2KΩ	PHRR01	Add \$200.00 per lockset
Deadbolt Privacy and Software House 1KΩ/2KΩ	PHRR03	Add \$200.00 per lockset
Deadbolt Privacy and AMAG 4-State	PHRR04	Add \$200.00 per lockset

Ordering Example Details

<b>BHMA CERTIFIED</b>	<b>ML20600 NAC</b>	ML20608	Single Cylinder
	Escutcheon Trim	SEC	Fail Secure
		104	Salvador Family Lever
		L	Escutcheon
		613	Finish
		RHR	Handing
		24 AD	24 Volt AC/DC

**Stock Order**

Quantity	Series/Function	Technology Code	Trim	Finish	Hand	Fail Safe/Fail Secure	High Security Monitoring Options
24	ML20608	NAC	133L	613	RHR	SEC	PHRR01



Corbin Russwin Architectural Hardware | 225 Episcopal Road | Berlin, CT 06037  
 Phone 800-543-3658 | Fax 800-447-6714 | corbinrusswinMUSEO.com

ASSA ABLOY, the global leader in door opening solutions

Price List. 43

September 1, 2017

# Electrically Controlled Mortise Locksets

ML20900 Series: Muséo Levers, Escutcheons, Roses and Thumbturns



contemporary levers to complement the interior design of your next project

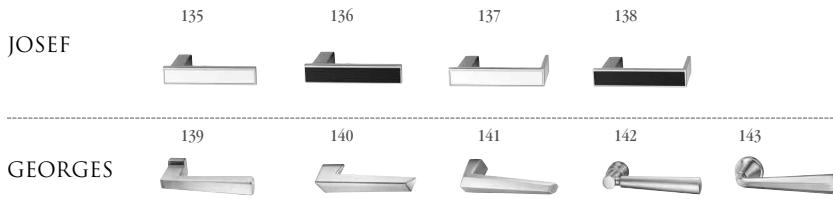

## ROSES

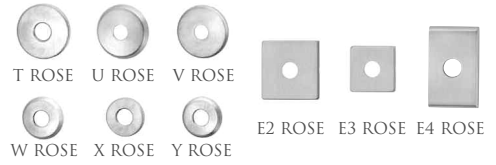

## ESCUTCHEONS



## THUMBTURNS<sup>3</sup>



1. Handed: specify hand when ordering
2. Contact factory for current lead time
3. Specify thumbturn as quick code. Thumbturn backplate will match shape of rose chosen (i.e. round or square). Not available with escutcheons.

613E	Dark Oxidized Satin Bronze - Equivalent	605	Bright Brass, Clear Coated	618	Bright Nickel Plated
626	Satin Chromium Plated	606	Satin Brass, Clear Coated	619	Satin Nickel Plated
		611	Bright Bronze, Clear Coated	625	Bright Chromium Plated
		612	Satin Bronze, Clear Coated	629	Bright Stainless Steel
		613	Dark Oxidized Satin Bronze, Oil Rubbed	630	Satin Stainless Steel
		613L	Dark Oxidized Satin Bronze, Clear Coated	722	Black Oxidized Bronze, Oil Rubbed

## Function

Lever with Escutcheons: L,R					
Single Cylinder	ML20914	Fail Safe/Fail Secure*	\$1,345.00		\$1,369.00
	ML20906				
No Cylinder Override	ML20907	Fail Safe/Fail Secure*	\$1,262.00		\$1,286.00
	ML20915				
Double Cylinder	ML20932	Fail Safe/Fail Secure*	\$1,428.00		\$1,452.00
Lever with Roses: V,U,T,Y,X,W,E2,E3,E4					
Single Cylinder	ML20914	Fail Safe/Fail Secure*	\$1,272.00		\$1,296.00
	ML20906				
No Cylinder Override	ML20907	Fail Safe/Fail Secure*	\$1,189.00		\$1,213.00
	ML20915				
Double Cylinder	ML20932	Fail Safe/Fail Secure*	\$1,355.00		\$1,379.00

\*Must specify: SAF for Fail Safe or SEC for Fail Secure.

## Ordering Example Details

<b>ML20900 ECL</b>	ML20914	Single Cylinder
Escutcheon Trim	SEC	Fail Secure
	135	Josef Family Lever
	L	Escutcheon
	613	Finish
	RHR	Handing
	24 AD	24 Volt AC/DC



Stock Order								
Quantity	Series/Function	Technology Code	Trim	Finish	Hand	Voltage	Fail Safe/Fail Secure	High Security Monitoring Options
24	ML20914	NAC	135L	613	RHR	24 AD	SEC	PHRR01

Copyright © 2002 - 2017 Corbin Russwin, Inc.



Corbin Russwin Architectural Hardware | 225 Episcopal Road | Berlin, CT 06037  
Phone 800-543-3658 | Fax 800-447-6714 | corbinrusswinMUSEO.com

ASSA ABLOY, the global leader in door opening solutions

Price List. 44

September 1, 2017



contemporary levers to complement the interior design of your next project

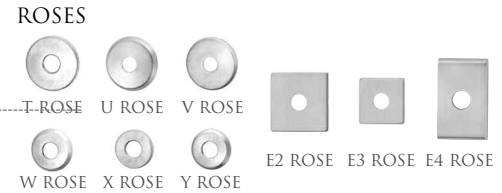
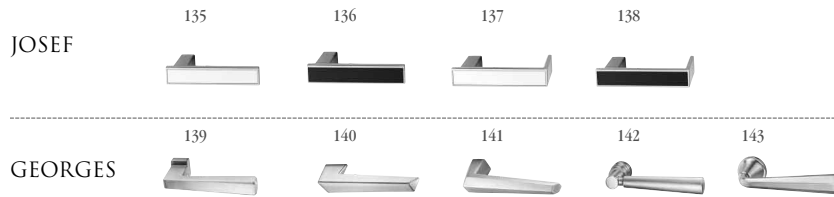

1. Handed: specify hand when ordering
2. Contact factory for current lead time
3. Specify thumbturn as quick code. Thumbturn backplate will match shape of rose chosen (i.e. round or square). Not available with escutcheons.

613E	Dark Oxidized Satin Bronze - Equivalent	605	Bright Brass, Clear Coated	618	Bright Nickel Plated
626	Satin Chromium Plated	606	Satin Brass, Clear Coated	619	Satin Nickel Plated
		611	Bright Bronze, Clear Coated	625	Bright Chromium Plated
		612	Satin Bronze, Clear Coated	629	Bright Stainless Steel
		613	Dark Oxidized Satin Bronze, Oil Rubbed	630	Satin Stainless Steel
		613L	Dark Oxidized Satin Bronze, Clear Coated	722	Black Oxidized Bronze, Oil Rubbed

**Function**

Lever with Escutcheons: L,R					
Single Cylinder	ML20606 x NAC	Fail Safe/Fail Secure	\$1,520.00		\$1,544.00
	ML20608 x NAC	Fail Safe/Fail Secure	\$1,595.00		\$1,619.00
No Cylinder Override	ML20607 x NAC	Fail Safe/Fail Secure	\$1,437.00		\$1,461.00
	ML20609 x NAC	Fail Safe/Fail Secure	\$1,512.00		\$1,536.00

Lever with Roses: V,U,T,Y,X,W,E2,E3,E4					
Single Cylinder	ML20606 x NAC	Fail Safe/Fail Secure	\$1,447.00		\$1,471.00
	ML20608 x NAC	Fail Safe/Fail Secure	\$1,522.00		\$1,546.00
No Cylinder Override	ML20607 x NAC	Fail Safe/Fail Secure	\$1,467.00		\$1,491.00
	ML20609 x NAC	Fail Safe/Fail Secure	\$1,542.00		\$1,566.00

\*Must specify: SAF for Fail Safe or SEC for Fail Secure.

**ML20600 High Security Monitoring Options**

Description	Specify	Add or Deduct
Mercury and Lenel compatible 1KΩ/2KΩ resistance supervision	R01	Add \$100.00 per lockset
Software House compatible 1KΩ/2KΩ resistance supervision	R03	Add \$100.00 per lockset
AMAG compatible 4-state supervision	R04	Add \$100.00 per lockset
Deadbolt Privacy Function	PHR	Add \$100.00 per lockset
Deadbolt Privacy and Mercury / Lenel 1KΩ/2KΩ	PHRR01	Add \$200.00 per lockset
Deadbolt Privacy and Software House 1KΩ/2KΩ	PHRR03	Add \$200.00 per lockset
Deadbolt Privacy and AMAG 4-State	PHRR04	Add \$200.00 per lockset

**BHMA CERTIFIED** Ordering Example Details →

ML20600 NAC Escutcheon Trim	ML20608	Single Cylinder
	SEC	Fail Secure
	104	Salvador Family Lever
	L	Escutcheon
	613	Finish
	RHR	Handing
	24 AD	24 Volt AC/DC

Stock Order							
Quantity	Series/Function	Technology Code	Trim	Finish	Hand	Fail Safe/Fail Secure	High Security Monitoring Options
24	ML20608	NAC	135L	613	RHR	SEC	PHRR01

*Electrically Controlled Mortise Locksets*  
 ML20900 Series: Muséo Levers, Escutcheons, Roses and Thumbturns



contemporary levers to complement the interior design of your next project



Specify thumbturn as quick code. Thumbturn backplate will match shape of rose chosen (i.e. round or square)

629	Bright Stainless Steel
630	Satin Stainless Steel

**Function**

Lever with Escutcheons: L,R			
Single Cylinder	ML20914	Fail Safe/Fail Secure*	\$1,297.00
	ML20906		
No Cylinder Override	ML20907	Fail Safe/Fail Secure*	\$1,214.00
	ML20915		
Double Cylinder	ML20932	Fail Safe/Fail Secure*	\$1,380.00
Lever with Roses: V,U,T,Y,X,W,E2,E3,E4			
Single Cylinder	ML20914	Fail Safe/Fail Secure*	\$1,224.00
	ML20906		
No Cylinder Override	ML20907	Fail Safe/Fail Secure*	\$1,141.00
	ML20915		
Double Cylinder	ML20932	Fail Safe/Fail Secure*	\$1,307.00

\*Must specify: SAF for Fail Safe or SEC for Fail Secure.

**BHMA CERTIFIED**  
 by ICCB, Inc. to meet ICCB Criteria

**ML20900 ECL**  
 Escutcheon  
 Trim

Ordering Example Details →

ML20914	Single Cylinder
SAF	Fail Safe
21M	Piet Family Lever - Polished with Satin Insert
L	Escutcheon
293029	Lever Finish
Polished with satin stainless steel insert (630), polished stainless steel (629) shank and polished stainless steel (629) grip	
629	Lock Finish
RHR	Handing
24 AD	24 Volt AC/DC

Stock Order							
Quantity	Series/Function	Fail Safe/Fail Secure	Trim	Lever Finish	Lock Finish	Hand	Voltage
2	ML20914	SAF	21ML	293029	629	RHR	24 AD

Copyright © 2002 - 2017 Corbin Russwin, Inc.



Corbin Russwin Architectural Hardware | 225 Episcopal Road | Berlin, CT 06037  
 Phone 800-543-3658 | Fax 800-447-6714 | corbinrusswinMUSEO.com

ASSA ABLOY, the global leader in door opening solutions

Price List. 46

September 1, 2017

contemporary levers to complement the interior design of your next project

PIET



ROSES



ESCUTCHEONS



THUMBTURNS



Specify thumbturn as quick code. Thumbturn backplate will match shape of rose chosen (i.e. round or square)

629	Bright Stainless Steel
630	Satin Stainless Steel

Function

Lever with Escutcheons: L,R			
Single Cylinder	ML20606 x NAC	Fail Safe/Fail Secure*	\$1,472.00
	ML20608 x NAC		\$1,547.00
No Cylinder Override	ML20607 x NAC	Fail Safe/Fail Secure*	\$1,389.00
	ML20609 x NAC		\$1,464.00
Lever with Roses: V,U,T,Y,X,W,E2,E3,E4			
Single Cylinder	ML20606 x NAC	Fail Safe/Fail Secure*	\$1,399.00
	ML20608 x NAC		\$1,474.00
No Cylinder Override	ML20607 x NAC	Fail Safe/Fail Secure*	\$1,316.00
	ML20609 x NAC		\$1,391.00

ML20600 High Security Monitoring Options

Description	Specify	Add or Deduct
Mercury and Lenel compatible 1KΩ/2KΩ resistance supervision	R01	Add \$100.00 per lockset
Software House compatible 1KΩ/2KΩ resistance supervision	R03	Add \$100.00 per lockset
AMAG compatible 4-state supervision	R04	Add \$100.00 per lockset
Deadbolt Privacy Function	PHR	Add \$100.00 per lockset
Deadbolt Privacy and Mercury / Lenel 1KΩ/2KΩ	PHRR01	Add \$200.00 per lockset
Deadbolt Privacy and Software House 1KΩ/2KΩ	PHRR03	Add \$200.00 per lockset
Deadbolt Privacy and AMAG 4-State	PHRR04	Add \$200.00 per lockset

\*Must specify: SAF for Fail Safe or SEC for Fail Secure.

Ordering Example Details

<b>ML20600 NAC</b>	ML20914	Single Cylinder
Escutcheon	SEC	Fail Secure
Trim	21W	Piet Family Lever - Wood Insert
	L	Escutcheon
	29BH29	Lever Finish Wood insert with polished stainless steel (629) shank and polished stainless steel (629) grip
	629	Lock Finish
	RHR	Handing
	24 AD	24 Volt AC/DC

Stock Order										
Qty	Series/Function	Tech. Code	Trim	Lever Finish	Finish	Hand	Voltage	Fail Safe/Fail Secure	High Security Monitoring Options	
2	ML20608	NAC	21ML	29BH29	629	RHR	24 AD	SEC	PHRR01	



Corbin Russwin Architectural Hardware | 225 Episcopal Road | Berlin, CT 06037  
Phone 800-543-3658 | Fax 800-447-6714 | corbinrusswinMUSEO.com

ASSA ABLOY, the global leader in door opening solutions

Price List. 47

September 1, 2017

# Electrically Controlled Mortise Locksets

ML20900 Series: Muséo Levers, Escutcheons, Roses and Thumbturns



contemporary levers to complement the interior design of your next project

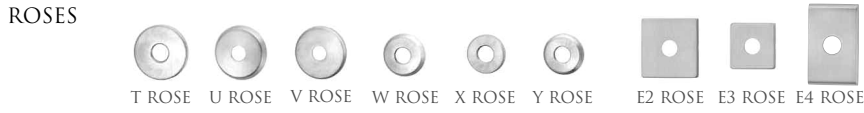

Specify thumbturn as quick code. Thumbturn backplate will match shape of rose chosen (i.e. round or square)

629 Bright Stainless Steel  
630 Satin Stainless Steel

## Function

Lever with Escutcheons: L,R			
Single Cylinder	ML20914	Fail Safe/Fail Secure*	\$1,369.00
	ML20906		
No Cylinder Override	ML20907	Fail Safe/Fail Secure*	\$1,286.00
	ML20915		
Double Cylinder	ML20932	Fail Safe/Fail Secure*	\$1,452.00
Lever with Roses: V,U,T,Y,X,W,E2,E3,E4			
Single Cylinder	ML20914	Fail Safe/Fail Secure*	\$1,296.00
	ML20906		
No Cylinder Override	ML20907	Fail Safe/Fail Secure*	\$1,213.00
	ML20915		
Double Cylinder	ML20932	Fail Safe/Fail Secure*	\$1,379.00

\*Must specify: SAF for Fail Safe or SEC for Fail Secure.



### Ordering Example Details

<b>ML20900 ECL</b>	ML20914 Single Cylinder
Escutcheon	SEC Fail Secure
Trim	21W Piet Family Lever - Wood Insert
	L Escutcheon
	29BH29 Lever Finish
	Wood insert with polished stainless steel (629) shank and polished stainless steel (629) grip
	629 Lock Finish
	RHR Handing
	24 AD 24 Volt AC/DC

### Stock Order

Quantity	Series/Function	Fail Safe/Fail Secure	Trim	Lever Finish	Lock Finish	Hand	Voltage
2	ML20914	SEC	21ML	29BH29	629	RHR	24 AD

Copyright © 2002 - 2017 Corbin Russwin, Inc.



Corbin Russwin Architectural Hardware | 225 Episcopal Road | Berlin, CT 06037  
Phone 800-543-3658 | Fax 800-447-6714 | corbinrusswinMUSEO.com

ASSA ABLOY, the global leader in door opening solutions

Price List. 48

September 1, 2017

*Electrically Controlled Mortise Locksets*  
 ML20600 NAC Series Electrified Mortise Lock with High Security Monitoring



contemporary levers to complement the interior design of your next project

PIET



ROSES



ESCUTCHEONS



THUMBTURNS



Specify thumbturn as quick code. Thumbturn backplate will match shape of rose chosen (i.e. round or square)

629	Bright Stainless Steel
630	Satin Stainless Steel

Function

Lever with Escutcheons: L,R			
Single Cylinder	ML20606 x NAC	Fail Safe/Fail Secure*	\$1,544.00
	ML20608 x NAC		\$1,619.00
No Cylinder Override	ML20607 x NAC	Fail Safe/Fail Secure*	\$1,461.00
	ML20609 x NAC		\$1,536.00
Lever with Roses: V,U,T,Y,X,W,E2,E3,E4			
Single Cylinder	ML20606 x NAC	Fail Safe/Fail Secure*	\$1,471.00
	ML20608 x NAC		\$1,546.00
No Cylinder Override	ML20607 x NAC	Fail Safe/Fail Secure*	\$1,388.00
	ML20609 x NAC		\$1,463.00

**ML20600 High Security Monitoring Options**

Description	Specify	Add or Deduct
Mercury and Lenel compatible 1KΩ/2KΩ resistance supervision	R01	Add \$100.00 per lockset
Software House compatible 1KΩ/2KΩ resistance supervision	R03	Add \$100.00 per lockset
AMAG compatible 4-state supervision	R04	Add \$100.00 per lockset
Deadbolt Privacy Function	PHR	Add \$100.00 per lockset
Deadbolt Privacy and Mercury / Lenel 1KΩ/2KΩ	PHRR01	Add \$200.00 per lockset
Deadbolt Privacy and Software House 1KΩ/2KΩ	PHRR03	Add \$200.00 per lockset
Deadbolt Privacy and AMAG 4-State	PHRR04	Add \$200.00 per lockset

\*Must specify: SAF for Fail Safe or SEC for Fail Secure.

BHMA CERTIFIED Ordering Example Details

<b>ML20600 NAC</b>	ML20608 Single Cylinder
Escutcheon Trim	SEC Fail Secure
	21W Piet Family Lever - Wood Insert
	L Escutcheon
	29BH29 Lever Finish
	Wood insert with polished stainless steel (629) shank and polished stainless steel (629) grip
	629 Lock Finish
	RHR Handing
	24 AD 24 Volt AC/DC

Stock Order									
Qty	Series/Function	Tech. Code	Trim	Lever Finish	Finish	Hand	Voltage	Fail Safe/Fail Secure	High Security Monitoring Options
2	ML20608	NAC	21ML	29BH29	629	RHR	24 AD	SEC	PHRR01



Corbin Russwin Architectural Hardware | 225 Episcopal Road | Berlin, CT 06037  
 Phone 800-543-3658 | Fax 800-447-6714 | corbinrusswinMUSEO.com

ASSA ABLOY, the global leader in door opening solutions

Price List. 49

September 1, 2017

# Access 800® AC2 Mortise Locksets

ML20800 Series: Muséo Levers

# MUSÉO®

contemporary levers to complement the interior design of your next project

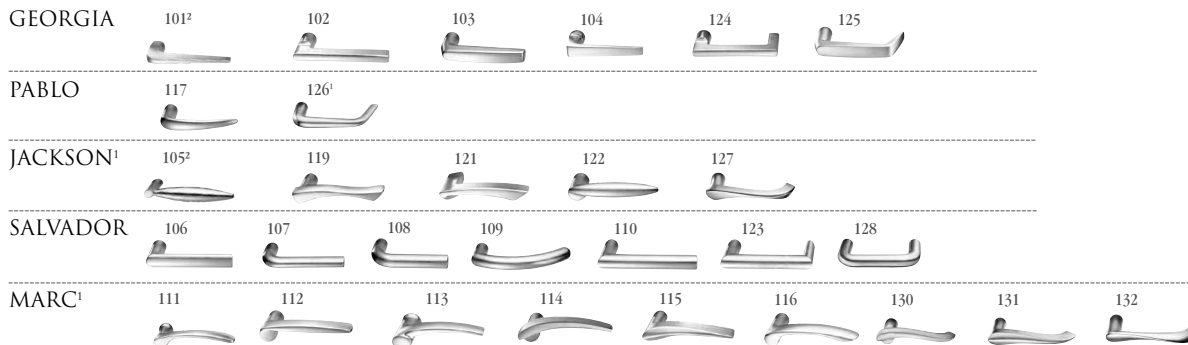

1. Handed: specify hand when ordering.
2. Contact factory for current lead time.

\*629 and \*630 finish options are Not available for all Muséo levers. Please refer to page 20 for availability.

613E	Dark Oxidized Satin Bronze - Equivalent	605	Bright Brass, Clear Coated	618	Bright Nickel Plated
626	Satin Chromium Plated	606	Satin Brass, Clear Coated	619	Satin Nickel Plated
		611	Bright Bronze, Clear Coated	625	Bright Chromium Plated
		612	Satin Bronze, Clear Coated	629*	Bright Stainless Steel
		613	Dark Oxidized Satin Bronze, Oil Rubbed	630*	Satin Stainless Steel
		613L	Dark Oxidized Satin Bronze, Clear Coated	722	Black Oxidized Bronze, Oil Rubbed

Function Description

Levers: Georgia, Pablo, Jackson, Salvador, Marc

ML20833	Without key override x M800	\$1,111.00	\$1,213.00
ML20834	With key override x M800	\$1,194.00	\$1,296.00
ML20835	Deadbolt without key override x M800	\$1,125.00	\$1,227.00
ML20836	Deadbolt with key override x M800	\$1,208.00	\$1,310.00
ML20837*	Dormitory Entry with Deadbolt and inside lever switch x M802	\$1,795.00	\$1,897.00
	Dormitory Entry with Deadbolt and inside lever switch x M803	\$1,860.00	\$1,962.00

\*ML20837 only compatible with proximity readers, M802 and M803

## Access 800® Options

Description	Specify Quick Code	Add
100 User, keypad only	M800	No Charge
2000 User, keypad only	M801	\$155.00
2000 User, proximity only	M802	\$587.00
2000 User, keypad and proximity	M803	\$652.00
2000 User, keypad and RF actuation	M804	\$369.00
2000 User, proximity and RF actuation	M805	\$801.00
2000 User, keypad, proximity and RF actuation	M806	\$865.00
Gasket	M99	No Charge



Ordering Example Details

<b>ML20800</b>	ML20834	Key Override
	114	Marc Family Lever
	619	Finish
	RHR	Handing

## Stock Order

Quantity	Series/Function	Technology Code	Trim	Finish	Hand	Option
24	ML20834	TCAC2	114Z	619	RHR	M801

Copyright © 2002 - 2017 Corbin Russwin, Inc.



ASSA ABLOY

Corbin Russwin Architectural Hardware | 225 Episcopal Road | Berlin, CT 06037  
Phone 800-543-3658 | Fax 800-447-6714 | corbinrusswinMUSEO.com

ASSA ABLOY, the global leader in door opening solutions

Price List. 50

September 1, 2017

# Access 800® AC2 Mortise Locksets

ML20800 Series: Muséo Levers

# MUSÉO®

contemporary levers to complement the interior design of your next project

JOSEF



GEORGES



1. Handed: specify hand when ordering
2. Contact factory for current lead time

613E Dark Oxidized Satin Bronze - Equivalent  
626 Satin Chromium Plated

605 Bright Brass, Clear Coated  
606 Satin Brass, Clear Coated  
611 Bright Bronze, Clear Coated  
612 Satin Bronze, Clear Coated  
613 Dark Oxidized Satin Bronze, Oil Rubbed  
613L Dark Oxidized Satin Bronze, Clear Coated

618 Bright Nickel Plated  
619 Satin Nickel Plated  
625 Bright Chromium Plated  
629 Bright Stainless Steel  
630 Satin Stainless Steel  
722 Black Oxidized Bronze, Oil Rubbed

Function	Description		
<b>Levers: Georgia, Pablo, Jackson, Salvador, Marc</b>			
ML20833	Without key override x M800	\$1,189.00	\$1,213.00
ML20834	With key override x M800	\$1,272.00	\$1,296.00
ML20835	Deadbolt without key override x M800	\$1,203.00	\$1,227.00
ML20836	Deadbolt with key override x M800	\$1,286.00	\$1,310.00
ML20837*	Dormitory Entry with Deadbolt and inside lever switch x M802	\$1,873.00	\$1,897.00
	Dormitory Entry with Deadbolt and inside lever switch x M803	\$1,938.00	\$1,962.00

\*ML20837 only compatible with proximity readers, M802 and M803

## Access 800® Options

Description	Specify Quick Code	Add
100 User, keypad only	M800	No Charge
2000 User, keypad only	M801	\$155.00
2000 User, proximity only	M802	\$587.00
2000 User, keypad and proximity	M803	\$652.00
2000 User, keypad and RF actuation	M804	\$369.00
2000 User, proximity and RF actuation	M805	\$801.00
2000 User, keypad, proximity and RF actuation	M806	\$865.00
Gasket	M99	No Charge



Ordering Example Details

**ML20800** | ML20834 Key Override  
133 Josef Family Lever  
619 Finish  
RHR Handing

### Stock Order

Quantity	Series/Function	Technology Code	Trim	Finish	Hand	Option
24	ML20834	TCAC2	133Z	619	RHR	M801



**ASSA ABLOY**

Corbin Russwin Architectural Hardware | 225 Episcopal Road | Berlin, CT 06037  
Phone 800-543-3658 | Fax 800-447-6714 | corbinrusswinMUSEO.com

ASSA ABLOY, the global leader in door opening solutions

Price List. 51

September 1, 2017

# Access 800® AC2 Mortise Locksets

ML20800 Series: Muséo Levers

# MUSÉO®

contemporary levers to complement the interior design of your next project

PIET



Function Description

629 Bright Stainless Steel  
630 Satin Stainless Steel

**Levers: Piet**

ML20833	Without key override x M800	\$1,213.00
ML20834	With key override x M800	\$1,296.00
ML20835	Deadbolt without key override x M800	\$1,227.00
ML20836	Deadbolt with key override x M800	\$1,310.00
ML20837 <sup>1</sup>	Dormitory Entry with Deadbolt and inside lever switch x M802	\$1,897.00
	Dormitory Entry with Deadbolt and inside lever switch x M803	\$1,962.00

### Access 800® Options

Description	Specify Quick Code	Add
100 User, keypad only	M800	No Charge
2000 User, keypad only	M801	\$155.00
2000 User, proximity only	M802	\$587.00
2000 User, keypad and proximity	M803	\$652.00
2000 User, keypad and RF actuation	M804	\$369.00
2000 User, proximity and RF actuation	M805	\$801.00
2000 User, keypad, proximity and RF actuation	M806	\$865.00



### Ordering Example Details

**ML20800** ML20834 Key Override  
21MZ Piet Family Lever - Polished with Satin Insert  
293029 Lever Finish  
Polished with satin stainless steel  
insert (630), polished stainless  
steel (629) shank and polished  
stainless steel (629) grip  
625 Lock Finish  
RHR Handing

### Stock Order

Quantity	Series/ Function	Technology Code	Trim	Lever Finish	Lock <sup>2</sup> Finish	Hand	Option
2	ML20834	TCAC2	21MZ	293029	625	RHR	M801

<sup>1</sup>ML20837 only compatible with proximity readers, M802 and M803

<sup>2</sup>Escutcheons (lock finish) are plated to match satin stainless steel (630) and polished stainless steel (629) finishes.

Copyright © 2002 - 2017 Corbin Russwin, Inc.



**ASSA ABLOY**

Corbin Russwin Architectural Hardware | 225 Episcopal Road | Berlin, CT 06037  
Phone 800-543-3658 | Fax 800-447-6714 | corbinrusswinMUSEO.com

ASSA ABLOY, the global leader in door opening solutions

Price List. 52

September 1, 2017



# Access 800® AC2 Exit Devices

ED5000 Series: Muséo Levers

# MUSÉO®

contemporary levers to complement the interior design of your next project

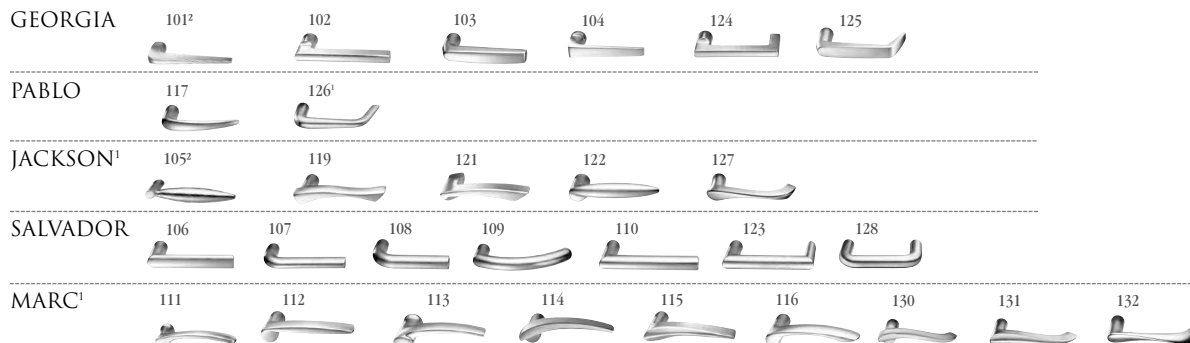

1. Handed: specify hand when ordering.
2. Contact factory for current lead time.

\*629 and \*630 finish options are Not available for all Muséo levers. Please refer to page 20 for availability.

### Levers: Georgia, Pablo, Jackson, Salvador, Marc

613E Dark Oxidized Satin Bronze - Equivalent	605 Bright Brass, Clear Coated	618 Bright Nickel Plated
630* Satin Stainless Steel	606 Satin Brass, Clear Coated	619 Satin Nickel Plated
	611 Bright Bronze, Clear Coated	625 Bright Chromium Plated
	612 Satin Bronze, Clear Coated	629* Bright Stainless Steel
	613 Dark Oxidized Satin Bronze, Oil Rubbed	722 Black Oxidized Bronze, Oil Rubbed
	613L Dark Oxidized Satin Bronze, Clear Coated	

Function	Description				
<b>Use with ED5200(S)(A) Rim/SecureBolt® Device</b>					
9833	Without key override x M800	\$1,193.00	\$1,213.00	Note: For key override, add Cylinder Quick Code Option and price. *When specifying function, prefix with lever design. Refer to page 230 for mechanical push bar pricing.	
9834	With key override x M800				
<b>Use with ED5633(A)L &amp; ED5634(A)L Mortise Device</b>					
9M833	Without key override x M800	\$1,152.00	\$1,172.00		
9M834	With key override x M800				

Note: 9M833 and 9M834 cannot be retrofitted to an existing ED5000 Series mortise device. When ordered as "Trim Only" 9M833 and 9M834 will be furnished with the appropriate mortise lock (refer to Parts Price List for mortise lock body pricing). If a "Trim Only" order is intended for retrofitting and exit device with an M91 Bolt Monitor or an M93 Trim Monitor function, that function must be specified with the trim order to ensure the correct lock is furnished.

### Access 800® Options

Description	Specify Quick Code	Add
100 User, keypad only	M800	No Charge
2000 User, keypad only	M801	\$155.00
2000 User, proximity only	M802	\$587.00
2000 User, keypad and proximity	M803	\$652.00
2000 User, keypad and RF actuation	M804	\$369.00
2000 User, proximity and RF actuation	M805	\$801.00
2000 User, keypad, proximity and RF actuation	M806	\$865.00
Gasket	M99	No Charge

Notes:

1. Available 0-bitted and Key Random (KR) only.
2. Available 0-bitted only.

**BHMA CERTIFIED** Ordering Example Details  
ED5000 Series

112 9M833 Marc Family Lever Mortise without key override function

Trim Only					
Quantity	Trim/Function	Technology Code	Finish	Hand	Options
24	1129M833	TCAC2	625	RHR	M800



Corbin Russwin Architectural Hardware | 225 Episcopal Road | Berlin, CT 06037  
Phone 800-543-3658 | Fax 800-447-6714 | corbinrusswinMUSEO.com

ASSA ABLOY, the global leader in door opening solutions

Price List. 53

September 1, 2017

# Access 800® AC2 Exit Devices

ED5000 Series: Muséo Levers



contemporary levers to complement the interior design of your next project

## JOSEF



## GEORGES



1. Handed: specify hand when ordering
2. Contact factory for current lead time

### Levers: Georgia, Pablo, Jackson, Salvador, Marc

613E Dark Oxidized Satin Bronze - Equivalent	605 Bright Brass, Clear Coated	618 Bright Nickel Plated
630 Satin Stainless Steel	606 Satin Brass, Clear Coated	619 Satin Nickel Plated
	611 Bright Bronze, Clear Coated	625 Bright Chromium Plated
	612 Satin Bronze, Clear Coated	629 Bright Stainless Steel
	613 Dark Oxidized Satin Bronze, Oil Rubbed	722 Black Oxidized Bronze, Oil Rubbed
	613L Dark Oxidized Satin Bronze, Clear Coated	

Function	Description			
<b>Use with ED5200(S)(A) Rim/SecureBolt® Device</b>				
9833	Without key override x M800		\$1,203.00	\$1,223.00
9834	With key override x M800			
<b>Use with ED5633(A)L &amp; ED5634(A)L Mortise Device</b>				
9M833	Without key override x M800		\$1,162.00	\$1,182.00
9M834	With key override x M800			

Note: For key override, add Cylinder Quick Code Option and price.  
 \*When specifying function, prefix with lever design.  
 Refer to page 230 for mechanical push bar pricing.

Note: For key override, add Cylinder Quick Code Option and price. See page 93.  
 \*When specifying function, prefix with lever design.  
 Refer to page 230 for mechanical push bar pricing.

Note: 9M833 and 9M834 cannot be retrofitted to an existing ED5000 Series mortise device. When ordered as "Trim Only" 9M833 and 9M834 will be furnished with the appropriate mortise lock (refer to Parts Price List for mortise lock body pricing). If a "Trim Only" order is intended for retrofitting and exit device with an M91 Bolt Monitor or an M93 Trim Monitor function, that function must be specified with the trim order to ensure the correct lock is furnished.

### Access 800® Options

Description	Specify Quick Code	Add
100 User, keypad only	M800	No Charge
2000 User, keypad only	M801	\$155.00
2000 User, proximity only	M802	\$587.00
2000 User, keypad and proximity	M803	\$652.00
2000 User, keypad and RF actuation	M804	\$369.00
2000 User, proximity and RF actuation	M805	\$801.00
2000 User, keypad, proximity and RF actuation	M806	\$865.00
Gasket	M99	No Charge

- Notes:
1. Available 0-bitted and Key Random (KR) only.
  2. Available 0-bitted only.



Ordering Example Details  
**ED5000 Series**

133 Josef Family Lever  
 9M833 Mortise without key override function

Trim Only					
Quantity	Trim/Function	Technology Code	Finish	Hand	Options
24	1339M833	TCAC2	625	RHR	M800



Corbin Russwin Architectural Hardware | 225 Episcopal Road | Berlin, CT 06037  
 Phone 800-543-3658 | Fax 800-447-6714 | corbinrusswinMUSEO.com

ASSA ABLOY, the global leader in door opening solutions

Price List. 54

September 1, 2017

# Access 800® AC2 Exit Devices

ED5000 Series: Muséo Levers

# MUSÉO®

contemporary levers to complement the interior design of your next project

PIET



Function Description

629 Bright Stainless Steel  
630 Satin Stainless Steel

Use with ED5200(S)(A) Rim/SecureBolt® Device		
9833	Without key override x M800	\$1,223.00
9834	With key override x M800	
Use with ED5633(A)L & ED5634(A)L Mortise Device		
9M833	Without key override x M800	\$1,182.00
9M834	With key override x M800	

Note: 9M833 and 9M834 cannot be retrofitted to an existing ED5000 Series mortise device. When ordered as "Trim Only" 9M833 and 9M834 will be furnished with the appropriate mortise lock (refer to Parts Price List for mortise lock body pricing). If a "Trim Only" order is intended for retrofitting and exit device with an M91 Bolt Monitor or an M93 Trim Monitor function, that function must be specified with the trim order to ensure the correct lock is furnished.

## Access 800® Options

Description	Specify Quick Code	Add
100 User, keypad only	M800	No Charge
2000 User, keypad only	M801	\$155.00
2000 User, proximity only	M802	\$587.00
2000 User, keypad and proximity	M803	\$652.00
2000 User, keypad and RF actuation	M804	\$369.00
2000 User, proximity and RF actuation	M805	\$801.00
2000 User, keypad, proximity and RF actuation	M806	\$865.00
Gasket	M99	No Charge

Notes:

1. Available 0-bitted and Key Random (KR) only.
2. Available 0-bitted only.



### Ordering Example Details

**ED5000 Series**

21W Piet Family Lever - Wood Insert  
9M833 Mortise without key override function  
29BH29 Lever Finish  
Wood insert with polished stainless steel (629) shank and polished stainless steel (629) grip  
625 Lock Finish  
RHR Handing

Trim Only						
Quantity	Trim/Function	Technology Code	Lever Finish	Lock <sup>2</sup> Finish	Hand	Option
2	21W9M833	TCAC2	29BH29	625	RHR	M800

<sup>2</sup>Escutcheons (lock finish) are plated to match satin stainless steel (630) and polished stainless steel (629) finishes.



Corbin Russwin Architectural Hardware | 225 Episcopal Road | Berlin, CT 06037  
Phone 800-543-3658 | Fax 800-447-6714 | corbinrusswinMUSEO.com

ASSA ABLOY, the global leader in door opening solutions

Price List. 55

September 1, 2017

# Pushpad Exit Devices

ED4000 Series: Muséo Levers with 800 Series Escutcheon

# MUSÉO®

contemporary levers to complement the interior design of your next project

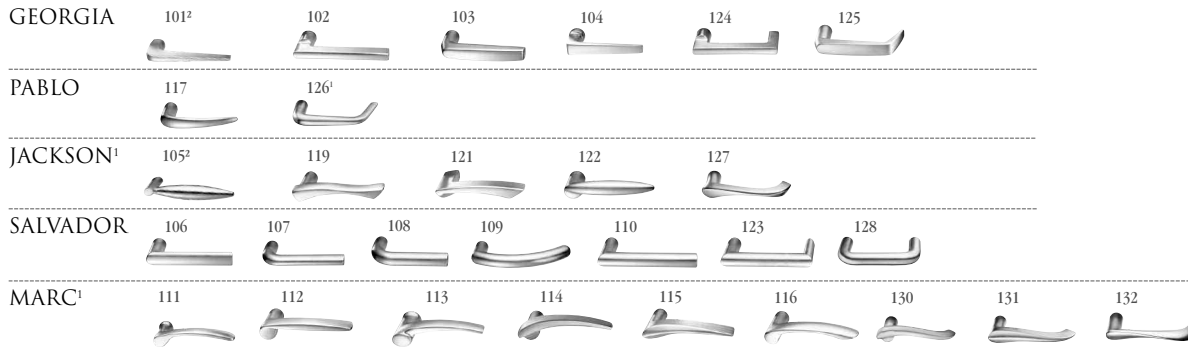

Parabolic Trim  
Specify: M60



Standard Trim

1. Handed: specify hand when ordering
2. Contact factory for current lead time

\*629 and \*630 finish options are Not available for all Muséo levers. Please refer to page 20 for availability.

613E Dark Oxidized Satin Bronze - Equivalent  
630\* Satin Stainless Steel

605 Bright Brass, Clear Coated  
606 Satin Brass, Clear Coated  
611 Bright Bronze, Clear Coated  
612 Satin Bronze, Clear Coated  
613 Dark Oxidized Satin Bronze, Oil Rubbed  
613L Dark Oxidized Satin Bronze, Clear Coated  
618 Bright Nickel Plated  
619 Satin Nickel Plated  
625 Bright Chromium Plated  
629\* Bright Stainless Steel  
722 Black Oxidized Bronze, Oil Rubbed

### Function

<b>Rim/SVR/CVR</b>	810 850 957	Passage Dummy Nightlatch	\$633.00	\$659.00
<b>Options</b>	M60	Parabolic Escutcheon	Add \$78.00 per device	Add \$78.00 per device

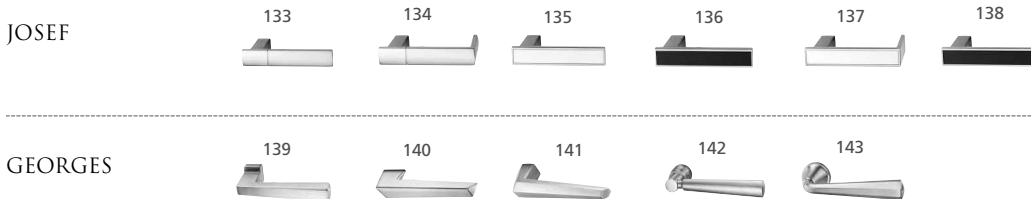

Parabolic Trim  
Specify: M60



Standard Trim

1. Handed: specify hand when ordering
2. Contact factory for current lead time

613E Dark Oxidized Satin Bronze - Equivalent  
630\* Satin Stainless Steel

605 Bright Brass, Clear Coated  
606 Satin Brass, Clear Coated  
611 Bright Bronze, Clear Coated  
612 Satin Bronze, Clear Coated  
613 Dark Oxidized Satin Bronze, Oil Rubbed  
613L Dark Oxidized Satin Bronze, Clear Coated  
618 Bright Nickel Plated  
619 Satin Nickel Plated  
625 Bright Chromium Plated  
629\* Bright Stainless Steel  
722 Black Oxidized Bronze, Oil Rubbed

<b>Rim/SVR/CVR</b>	810 850 957	Passage Dummy Nightlatch	\$625.00	\$651.00
<b>Options</b>	M60	Parabolic Escutcheon	Add \$78.00 per device	Add \$78.00 per device

# Pushpad Exit Devices

ED4000 Series: Muséo Levers with 800 Series Escutcheon

# MUSÉO®

contemporary levers to complement the interior design of your next project

PIET



Parabolic Trim  
Specify: M60



Standard Trim

629	Bright Stainless Steel
630	Satin Stainless Steel

### Function

<b>Rim/SVR/CVR</b>	810	Passage		\$659.00
	850	Dummy		
	957	Nightlatch		
<b>Options</b>	M60	Parabolic Escutcheon		Add \$78.00 per device

contemporary levers to complement the interior design of your next project

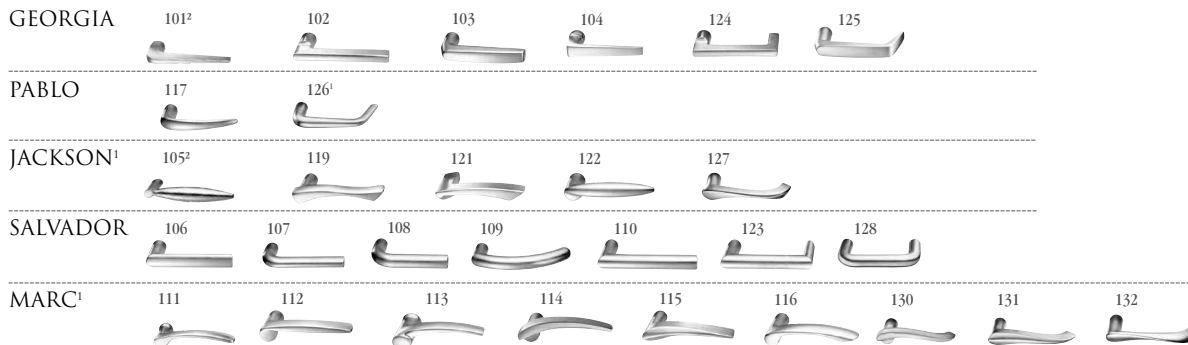

Parabolic Trim  
Specify: M60



Standard Trim

1. Handed: specify hand when ordering
2. Contact factory for current lead time

\*629 and \*630 finish options are Not available for all Muséo levers. Please refer to page 20 for availability.

613E	Dark Oxidized Satin Bronze - Equivalent
630*	Satin Stainless Steel

605	Bright Brass, Clear Coated
606	Satin Brass, Clear Coated
611	Bright Bronze, Clear Coated
612	Satin Bronze, Clear Coated
613	Dark Oxidized Satin Bronze, Oil Rubbed
613L	Dark Oxidized Satin Bronze, Clear Coated
618	Bright Nickel Plated
619	Satin Nickel Plated
625	Bright Chromium Plated
629*	Bright Stainless Steel
722	Black Oxidized Bronze, Oil Rubbed

**Function**

<b>Rim/SVR/CVR</b>	910	Passage		
	950	Dummy		
	955	Classroom	\$633.00	\$659.00
	957	Nightlatch		
	959	Storeroom		
<b>Mortise</b>	9M10	Passage		
	9M50	Dummy	\$633.00	\$659.00
	9M55	Classroom		
	9M57	Nightlatch		
<b>Electrified</b>	9903	Fail Safe	\$1,021.00	\$1,047.00
	9905	Fail Secure		
<b>Options</b>	M60	Parabolic Escutcheon	Add \$78.00 per device	Add \$78.00 per device

Ordering Example Details

- 111 Marc family lever
- 9M50 Dummy Trim; Mortise
- 625 Bright Chrome finish
- RHR Right Hand Reverse
- D214 2-1/4" Door Thickness
- M60 Parabolic Escutcheon Design (mechanical)



Trim Only					
Quantity	Trim/Function	Finish	Hand	Door Thickness	Option
24	1119M50	625	RHR	D214	M60

# Pushpad Exit Devices

ED5000 Series: Muséo Levers with 900 Series Escutcheon

# MUSÉO®

contemporary levers to complement the interior design of your next project

## JOSEF



Parabolic Trim  
Specify: M60

## GEORGES



Standard Trim

1. Handed: specify hand when ordering
2. Contact factory for current lead time

613E	Dark Oxidized Satin Bronze - Equivalent	605	Bright Brass, Clear Coated
630	Satin Stainless Steel	606	Satin Brass, Clear Coated
		611	Bright Bronze, Clear Coated
		612	Satin Bronze, Clear Coated
		613	Dark Oxidized Satin Bronze, Oil Rubbed
		613L	Dark Oxidized Satin Bronze, Clear Coated
		618	Bright Nickel Plated
		619	Satin Nickel Plated
		625	Bright Chromium Plated
		629	Bright Stainless Steel
		722	Black Oxidized Bronze, Oil Rubbed

## Function

Function	Model	Description	Price	Option Price
Rim/SVR/CVR	910	Passage		
	950	Dummy		
	955	Classroom	\$625.00	\$651.00
	957	Nightlatch		
	959	Storeroom		
Mortise	9M10	Passage		
	9M50	Dummy	\$625.00	\$659.00
	9M55	Classroom		
	9M57	Nightlatch		
Electrified	9903	Fail Safe	\$1,029.00	\$1,055.00
	9905	Fail Secure		
Options	M60	Parabolic Escutcheon	Add \$78.00 per device	Add \$78.00 per device

## Ordering Example Details

- 133 Josef family lever
- 9M50 Dummy Trim; Mortise
- 625 Bright Chrome finish
- RHR Right Hand Reverse
- D214 2-1/4" Door Thickness
- M60 Parabolic Escutcheon Design (mechanical)



Trim Only					
Quantity	Trim/Function	Finish	Hand	Door Thickness	Option
24	1339M50	625	RHR	D214	M60



Corbin Russwin Architectural Hardware | 225 Episcopal Road | Berlin, CT 06037  
Phone 800-543-3658 | Fax 800-447-6714 | corbinrusswinMUSEO.com

ASSA ABLOY, the global leader in door opening solutions

Price List. 59

September 1, 2017

# Pushpad Exit Devices

ED5000 Series: Muséo Levers with 900 Series Escutcheon

# MUSÉO®

contemporary levers to complement the interior design of your next project

PIET



Parabolic Trim  
Specify: M60

Standard Trim

629	Bright Stainless Steel
630	Satin Stainless Steel

## Function

<b>Rim/SVR/CVR</b>	910	Passage	\$659.00
	950	Dummy	
	955	Classroom	
	957	Nightlatch	
	959	Storeroom	
<b>Mortise</b>	9M10	Passage	\$659.00
	9M50	Dummy	
	9M55	Classroom	
	9M57	Nightlatch	
<b>Electrified</b>	9903	Fail Safe	\$1,047.00
	9905	Fail Secure	
<b>Options</b>	M60	Parabolic Escutcheon	Add \$78.00 per device



## Ordering Example Details

21M Piet Family Lever - Polished with Satin Insert  
 9M50 Dummy Trim; Mortise  
 293029 Lever Finish  
 Polished with satin stainless steel insert (630), polished stainless steel (629) shank and polished stainless steel (629) grip  
 629 Lock Finish  
 D214 2-1/4" Door Thickness  
 M60 Parabolic Escutcheon Design (mechanical)

Trim Only						
Quantity	Trim/Function	Lever Finish	Lock Finish	Hand	Door Thickness	Option
2	21M9M50	293029	629	RHR	D214	M60



**Standard Features**

**Keying**

0-bitted except high security; random keying option offered at no charge

**Keys**

Two nickel silver keys

**Pins**

5-pin for 252, 752, 852 and A Class; all others furnished 6-pin

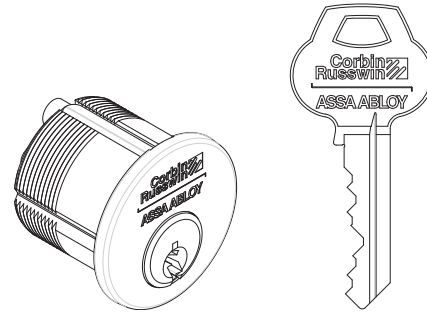

**Ordering Examples**

**Stock Order - Conventional Cylinder**

Quantity	Cylinder	Finish
25	1000	626

**Contract/Detailed Order - Conventional Cylinder**

Quantity	Keyset	Cylinder	Finish	Option
25	AA1	1000-138-A02-7	626	CKC2

**Stock Order - IC Cylinder**

Quantity	Cylinder	Finish
20	1080	626

**Contract/Detailed Order - IC Cylinder**

Quantity	Keyset	Cylinder	Finish	Misc.Option
4	AF3	1080-112-A04-7	606	CKC2

**Masterkey Service Fee:**

The value-added service of a customized masterkey security solution is provided when requested for a nominal charge with the purchase of complete Corbin Russwin keyed locking devices. In addition to the standard masterkeying charge, a masterkey service charge will be assessed, based on quantity, cylinder type, key system type, for an order that includes only Corbin Russwin cylinders or cores for use in non- Corbin Russwin manufactured locking devices for which Corbin Russwin has an equivalent.

### Keying

Description	Specify Quick Code	Add or Deduct
Keyed random <sup>3</sup>	KR	No Charge
Masterkey Service Fee. Applies to cylinders not being installed in Assa Abloy products		Consult Factory
Master keyed (all cylinders except 8000, 8020, 8027 IC, 8500, 8600, 8700 core)	specify keyset	Add \$16.00 per cylinder
Master keyed Pyramid (except 8020, 8027 IC core)	specify keyset	Add \$16.00 per cylinder
Master keyed Access 3 (except 8500, 8600, 8700 IC core)	specify keyset	Add \$16.00 per cylinder
Master keyed Security (including IC cylinder and core)	specify keyset	Add \$16.00 per cylinder
Master keyed (8000, 8020, 8027 IC core 8500, 8600, 8700)	specify keyset	No Charge
Master keyed to customer bittings or sample key	specify keyset	Add \$16.00 per cylinder
Construction master keyed <sup>1,2</sup>	CMK	Add \$16.00 per cylinder
Temporary Construction core, 6-pin (Red, Blue or Green) including Access 3 AP & AS	CT6R, CT6B, CT6G	No Charge
Temporary Construction core, 7-pin (Red, Blue or Green)	CT7R, CT7B, CT7G	No Charge
Temporary Construction core, 6-pin (Red, Blue or Green) Access 3 AHS	CT6AHR, CT6AHB, CT6AHG	No Charge
Temporary Construction core, Access 3 Pyramid	CTP	No Charge
Temporary Disposable core <sup>7</sup>	CT6D, CT7D, CTPD	No Charge
Small Format Temporary Disposable Cores <sup>7</sup>	CTSD	No Charge
Uncombined (Access 3, Pyramid, Security fixed and IC core) <sup>8</sup>	UC	Deduct \$8.00
Uncombined (conventional 8000 IC core) <sup>8</sup>	UC	Deduct \$2.00
Bump-Resistant Cylinder; Standard on Access 3 except LFIC	BRP	Add \$23.00 per cylinder
More than 2 keys per lock	KY# (e.g., KY6)	See Cut Keys Section Below

### Stamping

Visual key control (VKC)		
- No stamping	VKC0	\$4.50
- Keys only	VKC1	No Charge
- Cylinders and Keys <sup>4</sup>	VKC2	\$8.00
- Cylinders only <sup>4</sup>	VKC3	\$8.00
Concealed key control (CKC)		
- CKC cylinders with VKC keys	CKC2	\$8.00
- CKC cylinders only <sup>4</sup>	CKC3	\$8.00
DO NOT DUPLICATE	Order by number	see pages 69-74
End user custom die stamps* for key bows <sup>6</sup>		\$4.00
Other stamping on keys or cylinders <sup>6</sup> (Up to 7 characters on cylinders)		\$3.00 per character

\* For development of custom key stamp add one-time charge of \$840.00<sup>6</sup>. Dies property of Corbin Russwin.

### Cut Keys

	Conventional Keyway <sup>5</sup> Restricted Keyway		Protected Keyway		Security Keys	Pyramid Keys	Access 3		
	10 Series Bow	50 Series Bow	10 Series Bow	50 Series Bow	KB90 or KB92	KB28	AP	AS	AHS
Extra cut change keys with lockset/cylinder	\$5.30	\$5.80	\$6.30	\$6.70	\$19.50	\$10.30	\$5.20	\$10.30	\$10.30
Cut change keys without lockset/cylinder	\$11.00	\$11.50	\$12.00	\$12.40	\$19.50	\$15.00	\$11.00	\$16.10	\$16.10
Cut master keys (all levels) and control keys with or without lockset/cylinder	\$11.00	\$11.50	\$12.00	\$12.40	\$19.50	\$15.00	\$11.00	\$16.10	\$16.10
Cut construction master keys with or without lockset/cylinder	\$11.00	\$11.50	\$12.00	\$12.40	N/A	N/A	\$11.00	\$16.10	NA

Note: Two (2) cut change keys are provided per lockset or cylinder at no charge. Keyblanks cannot be substituted for cut keys. For keys with bows other than 10 and 90, specify "KB" + number as Quick Code, e.g. KB12. KB92 cannot be furnished with VKC or other markings. Cylinders pinned directly to GMK or MK level keys do not include cut keys. Please order GMK and MK keys separately.

**Notes:**

1. CMK Construction master keying charge is in addition to master keying charge.
2. CMK Construction master keying is not available in Pyramid or Security series.
3. Access 3 and Pyramid series is not available keyed random or 0-bitted.
4. VKC2, VKC3 is not available in Access 3, Pyramid or Security series.
5. Conventional cut change keys are furnished standard with key section, system type and bitting number.
6. Discount 50% only.
7. Disposable cores ordered separately - \$37.00 per set. Sold in multiples of 10 sets.
8. Keys, springs, and spring covers not included.

<b>Category</b>	<b>Description</b>	<b>Price</b>
Stock L4	Keyway used for stock orders and limited keying systems.	No Charge
Standard (see list at left)	Keyways in general use for keying systems.	No Charge
Restricted (not published)	Selective keyways for use in new and existing keying systems.	No Charge
Protected	Notice of Acceptance showing facilities name, address and contact information must be submitted to key records before orders can be processed. Key system administration approval required prior to processing of order.	No Charge
Pyramid	One of Corbin Russwin's line of high security cylinders	See Pyramid pages 75-80
Security	Old Emhart®/Security cylinders.	For existing systems only
Access 3	Corbin Russwin's highest level of key control.	See pages 69-74

## Key Systems Security Policy

The purpose of this security policy is to enforce our policies Access 3, Pyramid, Security, Protected & Restricted keyway product, including key system information.

No master key system information or security related product is to be given or sold to anyone other than the facility owner through written correspondence. Verification must be submitted (fax copy will be acceptable) to Key Systems Administration. The verification must be on the facility's letterhead and signed by a facility authorized systems administrator. Key Systems Administration does not maintain "Letters of Authorization" on file. Each order must be accompanied by proper authorization. Only after the authorization has been verified will the order be processed for production.

Also includes:

- Bitting information (even one bitting, absolutely no top-level master keys)
- Bitting lists (all formats; i.e., hard copy, disc)
- Key blanks and systems components for Access 3, Pyramid, protected and security cylinder systems.

Please note:

- No orders are to be processed through Key Systems Administration without proper authorization.
- Only orders with appropriate authorization attached will be given priority.
- Requests for systems information without proper authorization from the owner will be denied.
- Requests for information regarding the purchase of any systems support products as listed above will be referred to the local authorized sales agency.
- Refer to the current price lists for additional policies and procedures as they relate to this security policy.

Remember:

The purpose for the establishment of any security system is to provide an increased level of protection for the Facility owner.

## Construction Core Program

### How To Order

Use Quick Code CT6 for 6-PIN, CT7 for 7-PIN, and CTP for Access 3, Pyramid IC products. Use a separate purchase order or line item to order the permanent systems' core.

### Cut Keys

Specify the required number of change keys and control keys on the order. Two control keys are provided at no charge. Two change keys are provided at no charge for the first 20 units ordered. One additional change key is provided for every 10 additional units at no charge.

Examples: 25 units provide 2 operating keys; 30 units provide 3; 100 units provide 10. Additional keys will be invoiced at the prevailing cut key price.

### How To Return Cores

Contact your Customer Service Representative for a Returned Goods Authorization.

Provide the factory order number and year of the original order. Credit is issued for all cores returned in good operating condition, based on the price of a standard 6- or 7-pin core at the time of the original order.

Applicable discounts to the original unit are applied to the returned core.

Current pricing is as follows:	Price
6-PIN CONSTRUCTION CORE: (e.g. 8000-CT6) returned for credit	\$71.00
7-PIN CONSTRUCTION CORE: (e.g. 8000-CT7) returned for credit	\$73.00

## How To Price

Use Quick Code charts in lockset and exit device price sections.

1 ea. Lockset	ML2051 NSA 626	\$745.00	List Price
x Construction Core	CTP	\$59.00	List Price
		\$804.00	Subtotal
	Less 50/25% discount	\$301.50	Subtotal Net Price
1 ea. Pyramid Permanent Core	8027 x 626	\$99.00	List Price
	Less 50% discount	\$49.50	Net Price
		\$351.00	Subtotal Net Price
Return Construction Core	8000 Construction Core	\$59.00	List Price
	Less 50/25% discount	\$22.12	(Credit - RGA from factory)
		\$328.88	Your Total Cost

**Masterkey Service Fee:**

The value-added service of a customized masterkey security solution is provided when requested for a nominal charge with the purchase of complete Corbin Russwin keyed locking devices. In addition to the standard masterkeying charge, a masterkey service charge will be assessed, based on quantity, cylinder type, key system type, for an order that includes only Corbin Russwin cylinders or cores for use in non- Corbin Russwin manufactured locking devices for which Corbin Russwin has an equivalent.

### Keying

Description	Specify Quick Code	Add or Deduct
Keyed random <sup>3</sup>	KR	No Charge
Masterkey Service Fee. Applies to cylinders not being installed in Assa Abloy products		Consult Factory
Master keyed (all cylinders except 8000, 8020, 8027 IC, 8500, 8600, 8700 core)	specify keyset	Add \$16.00 per cylinder
Master keyed Pyramid (except 8020, 8027 IC core)	specify keyset	Add \$16.00 per cylinder
Master keyed Access 3 (except 8500, 8600, 8700 IC core)	specify keyset	Add \$16.00 per cylinder
Master keyed Security (including IC cylinder and core)	specify keyset	Add \$16.00 per cylinder
Master keyed (8000, 8020, 8027 IC core 8500, 8600, 8700)	specify keyset	No Charge
Master keyed to customer bittings or sample key	specify keyset	Add \$16.00 per cylinder
Construction master keyed <sup>1,2</sup>	CMK	Add \$16.00 per cylinder
Temporary Construction core, 6-pin (Red, Blue or Green) including Access 3 AP & AS	CT6R, CT6B, CT6G	No Charge
Temporary Construction core, 7-pin (Red, Blue or Green)	CT7R, CT7B, CT7G	No Charge
Temporary Construction core, 6-pin (Red, Blue or Green) Access 3 AHS	CT6AHR, CT6AHB, CT6AHG	No Charge
Temporary Construction core, Access 3 Pyramid	CTP	No Charge
Temporary Disposable core <sup>7</sup>	CT6D, CT7D, CTPD	No Charge
Small Format Temporary Disposable Cores <sup>7</sup>	CTSD	No Charge
Uncombined (Access 3, Pyramid, Security fixed and IC core) <sup>8</sup>	UC	Deduct \$8.00
Uncombined (conventional 8000 IC core) <sup>8</sup>	UC	Deduct \$2.00
Bump-Resistant Cylinder; Standard on Access 3 except LFIC	BRP	Add \$23.00 per cylinder
More than 2 keys per lock	KY# (e.g., KY6)	See Cut Keys Section Below

### Stamping

Visual key control (VKC)		
- No stamping	VKC0	\$4.50
- Keys only	VKC1	No Charge
- Cylinders and Keys <sup>4</sup>	VKC2	\$8.00
- Cylinders only <sup>4</sup>	VKC3	\$8.00
Concealed key control (CKC)		
- CKC cylinders with VKC keys	CKC2	\$8.00
- CKC cylinders only <sup>4</sup>	CKC3	\$8.00
DO NOT DUPLICATE	Order by number	see pages 69-74
End user custom die stamps* for key bows <sup>6</sup>		\$4.00
Other stamping on keys or cylinders <sup>6</sup> (Up to 7 characters on cylinders)		\$3.00 per character

\* For development of custom key stamp add one-time charge of \$840.00<sup>6</sup>. Dies property of Corbin Russwin.

### Cut Keys

	Conventional Keyway <sup>5</sup> Restricted Keyway		Protected Keyway		Security Keys	Pyramid Keys	Access 3		
	10 Series Bow	50 Series Bow	10 Series Bow	50 Series Bow	KB90 or KB92	KB28	AP	AS	AHS
Extra cut change keys with lockset/cylinder	\$5.00	\$5.50	\$6.00	\$6.40	\$19.50	\$10.30	\$5.20	\$10.30	\$10.30
Cut change keys without lockset/cylinder	\$11.00	\$11.50	\$12.00	\$12.40	\$19.50	\$15.00	\$11.00	\$16.10	\$16.10
Cut master keys (all levels) and control keys with or without lockset/cylinder	\$11.00	\$11.50	\$12.00	\$12.40	\$19.50	\$15.00	\$11.00	\$16.10	\$16.10
Cut construction master keys with or without lockset/cylinder	\$11.00	\$11.50	\$12.00	\$12.40	N/A	N/A	\$11.00	\$16.10	NA

Note: Two (2) cut change keys are provided per lockset or cylinder at no charge. Keyblanks cannot be substituted for cut keys. For keys with bows other than 10 and 90, specify "KB" + number as Quick Code, e.g. KB12. KB92 cannot be furnished with VKC or other markings. Cylinders pinned directly to GMK or MK level keys do not include cut keys. Please order GMK and MK keys separately.

**Notes:**

1. CMK Construction master keying charge is in addition to master keying charge.
2. CMK Construction master keying is not available in Pyramid or Security series.
3. Access 3 and Pyramid series is not available keyed random or 0-bitted.
4. VKC2, VKC3 is not available in Access 3, Pyramid or Security series.
5. Conventional cut change keys are furnished standard with key section, system type and bitting number.
6. Discount 50% only.
7. Disposable cores ordered separately - \$3.70 per set. Sold in multiples of 10 sets.
8. Keys, springs, and spring covers not included.

<b>Presentation Keys</b>		<b>Discount 50% Only</b>
Specify:	Key Symbol; Plating (nickel is standard); Stamping; Bow, if available for key class	
Standard Bow:	51 for all except below	
	90 for Security series	Nickel Plated \$112.00
	10 for 6PIN 852 & A Class keys	Gold Plated \$215.00

**Bitting Lists**

A letter of authorization from the end user is required to release a copy of the bitting lists for a factory established system. To protect the security of keying systems, bitting lists will only be sent to the end user or his designated agent, via Certified Mail Return Receipt Requested or UPS AOD. Copies will not be transmitted via fax. The complete name and address where the bitting list is to be sent must be indicated on the letter of authorization and on the purchase order.

Master key system bitting lists will not be created by Corbin Russwin Key Systems Administration unless the request is accompanied by an order for factory keyed product. Corbin Russwin releases all liabilities for cylinders not pinned to factory master key systems.

<b>Number of Bittings</b>	<b>Discount 50% Only</b>
1-50	\$195.00
51-200	\$299.00
201-1000	\$399.00
1001-3000	\$503.00
3001-6000*	\$588.00
6001-9000*	\$873.00
Over 9000*	Consult Key Systems Administration

\*Lead times may vary; consult Key Systems Administration

**NOTE:** Bitting Lists requested for keysets ordered with factory keyed product for either a new or existing system will be provided at no charge, except when KeyWizard® disc requested. For existing system pricing above will apply. For new system see page 50.

- Additional Bittings or P.O.'s for Bitting Lists Only – **EXISTING MASTER KEY GROUPS**  
Up to 10 **total** for keysets tied to **existing** master key groups will be provided at no charge  
11 or more bittings will be charged per above chart
- Additional Bittings or P.O.'s for Bitting Lists Only – **NEW MASTER KEY GROUPS**  
Regardless of the quantity being requested, will be charged per above chart

**Bitting lists will be billed at 50% off of list price – No additional discounts will apply.**

These prices are for a hierarchial Master Key system with no cross-keying of selected keys.  
For special requirements or for systems prior to 1999, consult Key Systems Administration for a quote.

Corbin Russwin releases all liabilities for cylinders not pinned to factory master key systems.

**Masterkey Service Fee:**

The value-added service of a customized masterkey security solution is provided when requested for a nominal charge with the purchase of complete Corbin Russwin keyed locking devices. In addition to the standard masterkeying charge, a masterkey service charge will be assessed, based on quantity, cylinder type, key system type, for an order that includes only Corbin Russwin cylinders or cores for use in non- Corbin Russwin manufactured locking devices for which Corbin Russwin has an equivalent.

Key Management Software		Discount 50% Only
Key Wizard® - Special online ordering procedures - contact customer service for more information		
Single Version - Order part number 68092		\$1,170.00
Network Version - Order part number 68093		\$1,375.00
Upgrade from Single Version to Network Version - Order part number 68095		\$707.00
Corbin Russwin factory key system formatted for importing to KeyWizard®. For existing systems, see Bitting Lists pricing on page 65. Note: Not available for key systems established prior to 1999. May not be available for systems since 1999. Consult Key Systems Administration for eligibility of system.		\$549.00
Key Systems Administration		
Customer bittings and sample keys 1,2,3,4,5		Add \$16.00 per cylinder <b>(Discount of 50% only)</b>
<p>Notes:</p> <ol style="list-style-type: none"> <li>1. This charge is for keying to customer supplied bittings only.</li> <li>2. All cylinders requested to be keyed to combinations not supplied by Corbin Russwin will be subject to this charge.</li> <li>3. Corbin Russwin releases all liabilities, including key interchange, to systems generated by customer-supplied bittings and/or sample keys that are supplied by others.</li> <li>4. Purchase orders with customer-supplied bittings or sample keys not meeting Corbin Russwin's specifications will be processed 0-bitted in the specified keyway and exempt from upcharge.</li> <li>5. Master keying or CMK charges not included.</li> </ol> <p><b>Disclaimer</b> Corbin Russwin reserves the right to release total liability of any factory generated master key system which incorporates cross keying, both controlled and uncontrolled. A master key system incorporating cross keying yields less security and jeopardizes system expansion.</p>		
Cross Keying		No Charge
<p><b>Controlled Cross Keying:</b> A condition in which two or more different keys of the same level of keying and under the same higher level key(s) operate one cylinder by design; e.g., XAA1 operated by AA2.</p> <p><b>Uncontrolled Cross Keying:</b> A condition in which two or more different keys under different higher-level keys operate one cylinder by design; e.g., XAA1 operated by AB, AB1.</p>		



**Stamping Key Section on Key Blanks**

Key blanks are furnished standard with no key section ID. When so specified, key blanks can be stamped with the key section at no charge. The minimum quantity for this service is a box of 50 key blanks

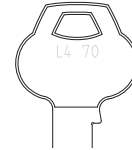

**Standard Bow, Nickel Silver (Order in multiples of 50)**



Coined Logo	Plain Both Sides	DO NOT DUPLICATE	US PROPERTY DO NOT DUPLICATE	RESTRICTED DO NOT DUPLICATE	Price Each		
					Standard Single Section	Restricted Single Section	Standard and Restricted Multi-Section**
(X1, Z1, R)*	(X4, Z4, P)*	(X5, Z5, P5)*	(X6, Z6, P6)*				
xx-5PIN-10	xx-5PIN-11	xx-5PIN-12	xx-5PIN-13	xx-5PIN-19	\$2.20	\$2.35	\$2.50
xx-6PIN-10	xx-6PIN-11	xx-6PIN-12	xx-6PIN-13	xx-6PIN-19			
xx-7PIN-10	xx-7PIN-11	xx-7PIN-12	xx-7PIN-13	xx-7PIN-19	\$2.27	\$2.42	\$2.52

\*(Old Reference)  
 \*\*Multi-section keys enter more than one keyway; eg. D12, H41, 2852, 9812, 59A, 57AD, 067, etc.  
 † Protected keyway keys will be stamped "Restricted"

**Pyramid (Available in quantities of 10, 25, 50 and multiples of 50)**

Standard bow furnished for all Pyramid Keys.



Key Blank Number	Description	Price Each
XX-7PIN-28	Single section	\$7.40
	Multi-section	\$14.00

**Access 3**



Key Blank Number	Description	Price Each
6PIN-38-AP	Standard key blanks for AP cylinders	\$3.90
6PIN-38-AS	Standard key blanks for AS & AHS cylinders	\$7.40

**Security Bow No other shape for security keys. (Order in multiples of 50)**

Not Available for 252, 752, 852, A, N, or X Class keys.  
Inactive, for existing systems only.



Coined Logo	Plain Both Sides	DO NOT DUPLICATE	US PROPERTY DO NOT DUPLICATE	RESTRICTED DO NOT DUPLICATE	Price Each
xx-6PIN-90	xx-6PIN-91	xx-6PIN-92	xx-6PIN-93	xx-6PIN-99	\$7.40
xx-7PIN-90 for hotel EMK					\$9.60

**Large Bows (Order in multiples of 50)**

Large Not Available for 252, 752, 852 or A Class keys.



Plain Both Sides	DO NOT DUPLICATE	US PROPERTY DO NOT DUPLICATE	RESTRICTED DO NOT DUPLICATE	Price Each	PROTECTED DO NOT DUPLICATE	Price Each
(Y4 and S)	(Y5 and S5)	(Y6 and S6)				
xx-5PIN-51	xx-5PIN-52	xx-5PIN-53	xx-5PIN-59	\$3.50	xx-5PIN-59	\$5.30
xx-6PIN-51	xx-6PIN-52	xx-6PIN-53	xx-6PIN-59		xx-6PIN-59	
xx-7PIN-51	xx-7PIN-52	xx-7PIN-53	xx-7PIN-59		xx-7PIN-59	

**Emergency Key Blanks for Hotel Function Access 3 Cylinder**

Description	Key Number	Price Each
Emergency key for mortise AP cylinders	6PIN-38-E2-AP	\$5.40
Emergency key for mortise AS & AHS cylinders	6PIN-38-E2-AS	\$7.60
Emergency key for key-in lever AP cylinders	6PIN-38-E6-AP	\$5.40
Emergency key for key-in lever AS & AHS cylinders	6PIN-38-E2-AS	\$7.60

**Emergency Master Key Blanks for Hotel Function Cylinder (Order in multiples of 10)**

Non-IC mortise cylinder use 7PIN blanks, as already listed: xx-7PIN-51 & xx-7PIN-90. (Order in multiples of 50)

Not Available for 252, 752, 852 or A Class keys.



Lockset	EMK Blank	Price Each
IC Mortise	xx-6PIN-51-E1	\$5.40
IC Mortise, Security	xx-6PIN-90-E1	\$7.60
CK4229, including IC; CK4429	xx-6PIN-51-E4	\$5.40
CK4229 Security, Including IC	xx-6PIN-90-E4	\$7.60
CL3329, CL3429, CL3629 6PIN, Including IC	xx-6PIN-51-E8	\$5.40
CL3329, CL3429, CL3629 7PIN, Including IC	xx-7PIN-51-E8	\$5.40
1400/4300 and 5600/3300 Series	xx-6PIN-51-E5	\$6.40

**Mortise Cylinder**

Cylinder Number	Description	Finish: 605, 606, 611, 612, 613, 613E, 618, 619, 622, 625, 626, 629, 630, 722
1500-114	ML2000 Series mortise locks (including electrified and EAC devices)	\$83.00
1500-114	DL3000 and DL4100 deadlocks	
1500-112	ED5600, ED6600 and ED7600 exit devices	
1500-134	All ED5000 cylinder dogging, alarm units, delayed egress cylinders	
1501-114-A01	AP Hotel Mortise Cylinder	\$119.00

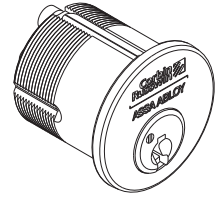

**Rim Cylinder**

Cylinder Number	Description	Finish: 605, 606, 611, 612, 613, 613E, 618, 619, 622, 625, 626, 629, 630, 722
3500-058	5/8" tailpiece	\$83.00
3500-138	1-3/8" M61 & M62 option for ED8200 and obsolete ED9200 exit device alarms; ED5202(A) inside cylinder	
3500-200	2" tailpiece	
3500-200N	2" ED4000/ED5000 night latch function	
3500-200V	2" vertical tailpiece	
3500-312	3-1/2" tailpiece	\$85.00
3500-312V	3-1/2" vertical tailpiece	

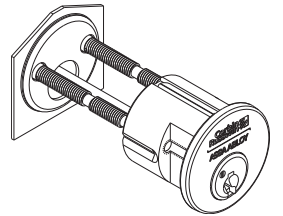

**AP LFIC - Mortise Cylinder**

Cylinder Number	Description	Finish: 605, 606, 611, 612, 613, 613E, 618, 619, 622, 625, 626, 629, 630, 722
1580-114	ML2000 Series mortise locks (including electrified and EAC devices)	\$154.00
1580-138	DL3000 and DL4100 deadlocks	\$157.00
1580-112	ED5600, ED6600 and ED7600 exit devices	
1580-134	All ED5000 cylinder dogging, alarm units, delayed egress cylinders	

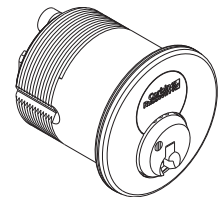

**AP LFIC - Rim Cylinder**

Cylinder Number	Description	Finish: 605, 606, 611, 612, 613, 613E, 618, 619, 622, 625, 626, 629, 630, 722
3580-058	5/8" tailpiece	\$154.00
3580-114	1-1/4" M61 & M62 option for ED8200 and ED9200 exit device alarms	
3580-178	1-7/8" tailpiece	
3580-178V	1-7/8" vertical tailpiece	
3580-318	3-1/8" tailpiece	\$156.00

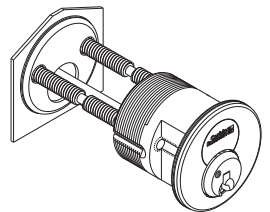

**AP LFIC Core**

Cylinder Number	Description	Finish: 605, 606, 611, 612, 613, 613E, 618, 619, 622, 625, 626, 629, 630, 722
8500	All Corbin Russwin LFIC cylinders	\$71.00

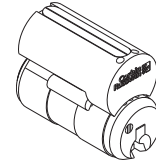

**AP Fixed Core Component Cylinder**

Cylinder Number	Description	Finish: 606, 626
2500-031	CL3100 Series Vandal Resistant, CK4300 Knob	\$76.00
2500-033	CL3300, CL3500, CL3600 (June 2000 and after), CL3800, Lever Trim - A6/N6/PR6	
2500-033H	G10 Exit Device Knob Trim	
2500-037	CL3700 Lever, CK4700 Knob	
2500-039	CL3900	
2500-039L	CL3900 Lever (2" and 2-1/4" Thick Door)	
2500-044	CK4400	
2500-052	CK4200/UT5200	

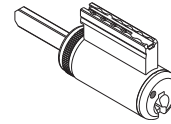

**AP Fixed Core Deadlock Cylinder**

Cylinder Number	Description	Finish: 606, 626
4500-134-A51	DL2200/DL3200 Series	\$76.00
4500-134-A52		
4500-214-A52		

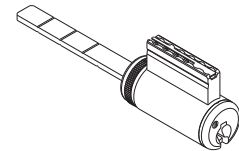

**AS Fixed Core - Mortise Cylinder**

Cylinder Number	Description	Finish: 605, 606, 611, 612, 613, 613E, 618, 619, 622, 625, 626, 629, 630, 722
1600-114	ML2000 Series mortise locks (including electrified and EAC devices)	\$132.00
1600-138	DL3000 and DL4100 deadlocks	
1600-112	ED5600, ED6600 and ED7600 exit devices	\$142.00
1600-134	All ED5000 cylinder dogging, alarm units, delayed egress cylinders	

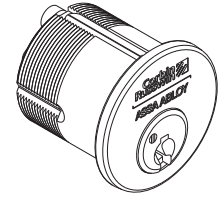

**AS Fixed Core - Rim Cylinder**

Cylinder Number	Description	Finish: 605, 606, 611, 612, 613, 613E, 618, 619, 622, 625, 626, 629, 630, 722
3600-058	5/8" tailpiece	\$132.00
3600-138	1-3/8" M61 & M62 option for ED8200 and obsolete ED9200 exit device alarms; ED5202(A) inside cylinder	
3600-200	2" tailpiece	
3600-200N	2" night latch function	
3600-200V	2" vertical tailpiece	
3600-312	3-1/2" tailpiece	\$134.00
3600-312V	3-1/2" vertical tailpiece	

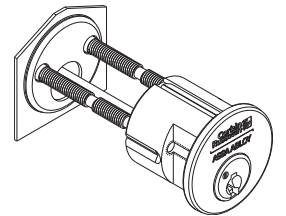

**AS LFIC - Mortise Cylinder**

Cylinder Number	Description	Finish: 605, 606, 611, 612, 613, 613E, 618, 619, 622, 625, 626, 629, 630, 722
1680-114	ML2000 Series mortise locks (including electrified and EAC devices)	\$203.00
1680-138	DL3000 and DL4100 deadlocks	\$206.00
1680-112	ED5600, ED6600 and ED7600 exit devices	
1680-134	All ED5000 cylinder dogging, alarm units, delayed egress cylinders	\$214.00

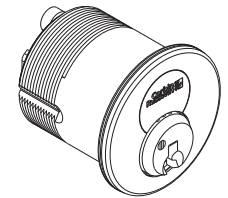

**AS LFIC - Rim Cylinder**

Cylinder Number	Description	Finish: 605, 606, 611, 612, 613, 613E, 618, 619, 622, 625, 626, 629, 630, 722
3680-058	5/8" tailpiece	\$203.00
3680-114	1-1/4" M61 & M62 option for ED8200 and ED9200 exit device alarms	
3680-178	1-7/8" tailpiece	
3680-178V	1-7/8" vertical tailpiece	
3680-318	3-1/8" tailpiece	
		\$205.00

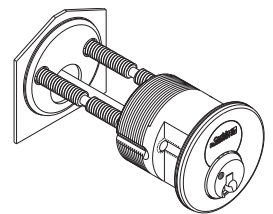

**AS LFIC Core**

Cylinder Number	Description	Finish: 605, 606, 611, 612, 613, 613E, 618, 619, 622, 625, 626, 629, 630, 722
8600	All Corbin Russwin LFIC Cylinders	\$120.00

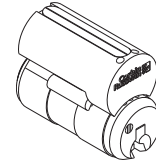

**AS Fixed Core Component Cylinder**

Cylinder Number	Description	Finish: 606, 626
2600-031	CL3100 Series Vandal Resistant, CK4300 Knob	\$125.00
2600-033	CL3300, CL3500, CL3600 (June 2000 and after), CL3800, Lever Trim - A6/N6/PR6	
2600-033H	G10 Exit Device Knob Trim	
2600-037	CL3700 Lever, CK4700 Knob	
2600-039	CL3900	
2600-039L	CL3900 Lever (2" and 2-1/4" Thick Door)	
2600-044	CK4400	
2600-052	CK4200/UT5200	

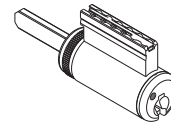

**AS Fixed Core Deadlock Cylinder**

Cylinder Number	Description	Finish: 606, 626
4600-134-A51	DL2200/DL3200 Series	\$125.00
4600-134-A52		
4600-214-A52		

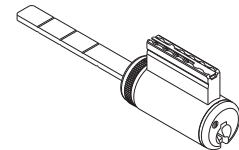

**AHS Fixed Core - Mortise Cylinder**

Cylinder Number	Description	Finish: 605, 606, 611, 612, 613, 613E, 618, 619, 622, 625, 626, 629, 630, 722
1700-114	ML2000 Series mortise locks (including electrified and EAC devices)	\$152.00
1700-138	DL3000 and DL4100 deadlocks	
1700-112	ED5600, ED6600 and ED7600 exit devices	\$162.00
1700-134	All ED5000 cylinder dogging, alarm units, delayed egress cylinders	

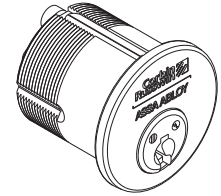

**AHS Fixed Core - Rim Cylinder**

Cylinder Number	Description	Finish: 605, 606, 611, 612, 613, 613E, 618, 619, 622, 625, 626, 629, 630, 722
3700-058	5/8" tailpiece	\$152.00
3700-138	1-3/8" M61 & M62 option for ED8200 and obsolete ED9200 exit device alarms; ED5202(A) inside cylinder	
3700-200	2" tailpiece	
3700-200N	2" night latch function	
3700-200V	2" vertical tailpiece	
3700-312	3-1/2" tailpiece	\$154.00
3700-312V	3-1/2" vertical tailpiece	

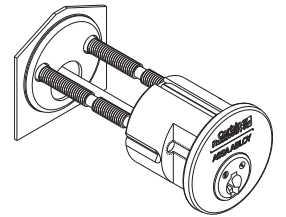

**AHS LFIC - Mortise Cylinder**

Cylinder Number	Description	Finish: 605, 606, 611, 612, 613, 613E, 618, 619, 622, 625, 626, 629, 630, 722
1788-114	ML2000 Series mortise locks (including electrified and EAC devices)	\$223.00
1788-138	DL3000 and DL4100 deadlocks	\$226.00
1788-112	ED5600, ED6600 and ED7600 exit devices	
1788-134	All ED5000 cylinder dogging, alarm units, delayed egress cylinders	\$234.00

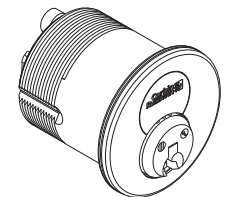

**AHS LFIC - Rim Cylinder**

Cylinder Number	Description	Finish: 605, 606, 611, 612, 613, 613E, 618, 619, 622, 625, 626, 629, 630, 722
3788-058	5/8" tailpiece	\$223.00
3788-114	1-1/4" M61 & M62 option for ED8200 and ED9200 exit device alarms	
3788-178	1-7/8" tailpiece	
3788-178V	1-7/8" vertical tailpiece	
3788-318	3-1/8" tailpiece	\$225.00

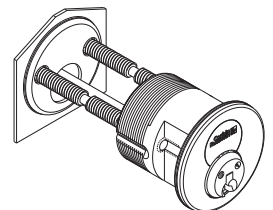

### AHS LFIC Core

Cylinder Number	Description	Finish: 605, 606, 611, 612, 613, 613E, 618, 619, 622, 625, 626, 629, 630, 722
8700	All Corbin Russwin LFIC cylinders	\$140.00

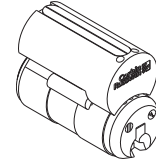

### AHS Fixed Core Component Cylinder

Cylinder Number	Description	Finish: 606, 626
2700-031	CL3100 Series Vandal Resistant, CK4300 Knob	\$145.00
2700-033	CL3300, CL3500, CL3600 (June 2000 and after), CL3800, Lever Trim - A6/N6/PR6	
2700-033H	G10 Exit Device Knob Trim	
2700-037	CL3700 Lever, CK4700 Knob	
2700-039	CL3900	
2700-039L	CL3900 Lever (2" and 2-1/4" Thick Door)	
2700-044	CK4400	
2700-052	CK4200/UT5200	

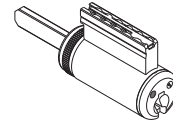

### AHS Fixed Core Deadlock Cylinder

Cylinder Number	Description	Finish: 606, 626
4700-134-A51	DL2200/3200 Series	\$145.00
4700-134-A52		
4700-214-A52		

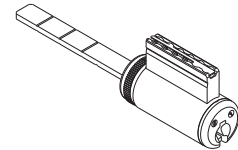

### UL LFIC 6-Pin Mortise Housing

Cylinder Number	Description	Finish: 605, 606, 611, 612, 613, 613E, 618, 619, 622, 625, 626, 629, 630, 722
1078-114	ML2000 Series mortise locks (including electrified and EAC devices)	\$83.00
1078-138	DL3000 and DL4100 deadlocks	\$86.00
1078-112	ED5600, ED6600 and ED7600 exit devices	
1078-134	All ED5000 cylinder dogging, alarm units, delayed egress cylinders	\$94.00

### UL LFIC 6-Pin Rim Housing

Cylinder Number	Description	Finish: 605, 606, 611, 612, 613, 613E, 618, 619, 622, 625, 626, 629, 630, 722
3078-058	5/8" tailpiece	\$83.00
3078-114	1-1/4" M61 & M62 option for ED8200 and ED9200 exit device alarms	
3078-178	1-7/8" tailpiece	
3078-178V	1-7/8" vertical tailpiece	
3078-318	3-1/8" tailpiece	\$85.00



**Fixed Core Mortise**

7-Pin - No Cross Keying - Furnished standard with 610502 solid recessed collar unless otherwise indicated.  
High Security UL437 Listed.

**Cylinder Number Example**

To simplify ordering, options designated "standard" may be omitted from the ordering sequence.



Length		Cam	Finish	
114	(1-1/4")	A01	605	619
		A02	606	622
112	(1-1/2")	A03	611	625
		A04	612	626
		A05	613	629
		A06 <sup>2</sup>	613E	630
			618	722
		A07		
		A62		
		A92		
		A93 <sup>1</sup>		
		For Obsolete Corbin® 610 Series and Russwin® 1403 Series Deadlock		
Cylinder No.			Price	
1020-114			\$167.00	

Notes: 1. Add \$2.00 per cylinder for A93 cam  
2. Add \$5.00 per cylinder for A06 cam

**Fixed Core Rim**

7-Pin - No Cross Keying - Furnished standard with 422F88 surface mount collar unless otherwise indicated.  
High Security UL437 Listed.

**Cylinder Number Example**

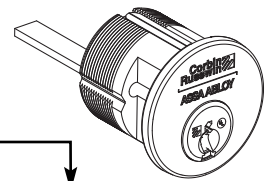
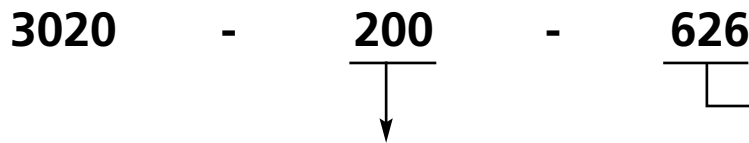

Tailpiece Length	Finish	
058 - 5/8"	605	619
138 - 1-3/8" M61 & M62 option for ED8200 and obsolete ED9200 exit device alarms	606	622
200 - 2"	611	625
200N - 2" ED4000/ED5000 Night Latch Function	612	626
200V - 2" vertical	613	629
312 - 3-1/2"	613E	630
312V - 3-1/2" vertical	618	722
Cylinder Number	Price	
3020 - _____	\$167.00	

**Key-In-Lever/Knob**

7-Pin - No Cross Keying

**High Security UL437 Listed**

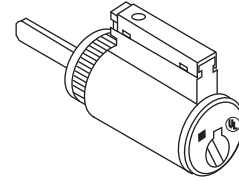

Cylinder Number	Used for	Finish: 606, 626
2020-031	CL3100 Lever, CK4300 Knob	\$158.00
2020-033	CL3300, CL3500, CL3800 [CL3600 (June 2000 and after)], A6, N6, PR6 Exit device trim	
2020-033H	G10 Exit device trim	
2020-034	CL3400, [CL3600 (prior to June 2000)], A5, N5 obsolete ED8000 trims	
2020-037	CL3700 Lever, CK4700 Knob	
2020-038	CL3800 Lever	
2020-039	CL3900 Lever	
2020-039L	CL3900 Lever (2" - 2-1/4" door)	
2020-051	G3 Exit Device Knob Trim	
2020-052	CK4200 Knob, UT5200 Knob and Lever	
4420-134-A51	DL2200, DL3200 Cylindrical Deadlock	
4420-134-A52	DL2200, DL3200 Cylindrical Deadlock	
4420-214-A52	DL2200, DL3200 Cylindrical Deadlock	

**Key-In-Lever/Knob**

For Other Manufacturers' Products

**High Security UL437 Listed**

Cylinder Number	Used for	Finish: 606, 626
2220-001-P21	Alarm Lock DL2500 Series	\$160.00
	Arrow® H Series Knobs and Levers	
	Arrow Q Series Levers	
	Sargent® 10 line (Enlarge Lever Hole)	
	Schlage® D Series Levers	
2220-002-P21	Schlage D Series Knobs	\$160.00
2220-001-P22	Schlage AL and ND Series Levers	
2220-002-P22	Schlage A Series Knobs (PLY, etc.)	
2220-002-P23	Schlage A Series Knob (ORB only)	

**IC Mortise**

7-Pin - No Cross Keying - Furnished standard with 610F02 solid recessed collar unless otherwise indicated.

**Cylinder Number Example**

To simplify ordering, options designated "standard" may be omitted from the ordering sequence.

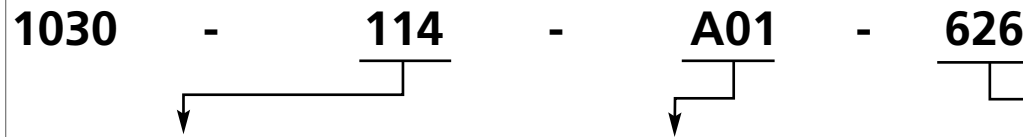
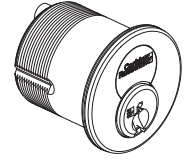

Length		Cam		Finish	
114	1-1/4"	A01	Cloverleaf (standard)	605	619
138	1-3/8"	A02	Straight	606	622
112	1-1/2"	A03	Adams Rite® MS & DL3000	611	625
134	1-3/4"	A04	DL4000 Deadlock	612	626
		A05	Adams Rite® 4070	613	629
		A06 <sup>2</sup>	Schlage® L9000	613E	630
		A07	DL4100 Series Deadlock	618	722
		A62	Straight		
		A92	Exit Grip 01, 02		
		A93 <sup>1</sup>	For Obsolete Corbin® 610 Series and Russwin® 1403 Series Deadlock		
Cylinder Number				Price	
1030-114				\$235.00	

Notes: 1. Add \$2.00 per cylinder for A93 cam.  
2. Add \$5.00 per cylinder for A06 cam.

**IC Rim**

7-Pin - No Cross Keying - Furnished standard with 422F88 surface mount collar unless indicated.

**Cylinder Number Example**

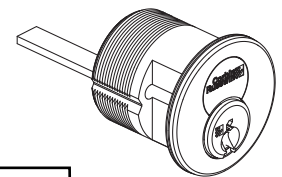

Tailpiece Length	Finish	
058 - 5/8"	605	619
114 - 1-1/4" M61 & M62 option for ED8200 and ED9200 exit device alarms	606	622
178 - 1-7/8"	611	625
178V - 1-7/8" vertical	612	626
318 - 3-1/8"	613	629
	613E	630
	618	722
Cylinder Number	Price	
3030-_____	\$235.00	

**Pyramid Core Only**

Cylinder Number	Price
8020	\$152.00

Note: For mortise and rim housing only, see page 91.

**Fixed Core Mortise**

7-Pin - No Cross Keying - Furnished standard with 605F43 spring collar unless otherwise indicated.

**Cylinder Number Example**

To simplify ordering, options designated "standard" may be omitted from the ordering sequence.

**1027 - 114 - A01 - 626**

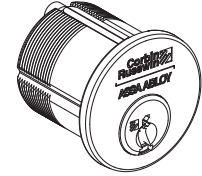

Length		Cam	Finish	
114	(1-1/4")	A01	605	619
		A02	606	622
112	(1-1/2")	A03	611	625
		A04	612	626
		A05	613	629
		A06 <sup>2</sup>	613E	630
		A07	618	722
		A62		
		A92		
		A93 <sup>1</sup>		
<b>Cylinder Number</b>			<b>Price</b>	
1027-114			\$138.00	

- Notes: 1. Add \$2.00 per cylinder for A93 cam.  
2. Add \$5.00 per cylinder for A06 cam.

**Fixed Core Rim**

7-Pin - No Cross Keying - Furnished standard with 422F88 surface mount collar unless otherwise indicated.

**Cylinder Number Example**

**3027 - 200 - 626**

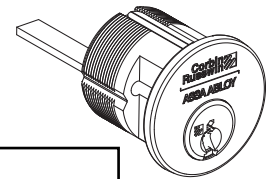

Tailpiece Length	Finish	
058 - 5/8"	605	619
138 - 1-3/8" M61 & M62 option for ED8200 and obsolete ED9200 exit device alarms	606	622
200 - 2"	611	625
200N - 2" ED4000/ED5000 Night Latch Function	612	626
200V - 2" (vertical)	613	629
312 - 3-1/2"	613E	630
312V - 3-1/2" (vertical)	618	722
<b>Cylinder Number</b>		<b>Price</b>
3027-_____		\$138.00

**Key-In-Lever/Knob**

7-Pin - No Cross Keying.

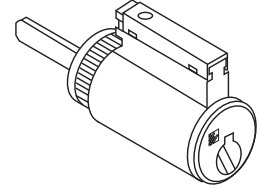

Cylinder Number	Used for	Finish: 606, 626
2027-031	CL3100 Lever, CK4300 Knob	\$131.00
2027-033	CL3300, CL3500, CL3800 [CL3600 (June 2000 and after)], A6, N6, PR6 Exit Device Trim	
2027-033H	G10 Exit device trim	
2027-034	CL3400, [CL3600 (before June 2000)], A5, N5 obsolete ED8000 trims	
2027-037	CL3700 Lever, CK4700 Knob	
2027-038	CL3800 Lever	
2027-039	CL3900 Lever	
2027-039L	CL3900 Lever (2" - 2-1/4" door)	
2027-051	G3 Exit Device Knob Trim	
2027-052	CK4200 knob, UT5200 Knob and Lever	
4427-134-A51	DL2200, DL3200 Cylindrical Deadlock	
4427-134-A52	DL2200, DL3200 Cylindrical Deadlock	
4427-214-A52	DL2200, DL3200 Cylindrical Deadlock	

**Key-In-Lever/Knob**

**For Other Manufacturer's Products**

Cylinder Number	Used for	Finish: 606, 626
2227-001-P21	Alarm Lock DL2500 Series	\$133.00
	Arrow® H Series Knobs and Levers	
	Arrow Q Series Levers	
	Sargent® 10 line (Enlarge Lever Hole)	
	Schlage® D Series Levers	
2227-002-P21	Schlage D Series Knobs	
2227-001-P22	Schlage AL and ND Series Levers	
2227-002-P22	Schlage A Series Knobs (PLY, etc.)	
2227-002-P23	Schlage A Series Knob (ORB only)	

**IC Mortise**

7-Pin - No Cross Keying - Furnished standard with 605F43 spring collar unless otherwise indicated.

**Cylinder Number Example**

To simplify ordering, options designated "standard" may be omitted from the ordering sequence.

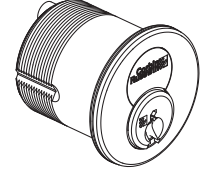

**1037 - 114 - A01 - 626**

Length	Cam		Finish	
114 1-1/4"	A01	Cloverleaf (standard)	605	619
138 1-3/8"	A02	Straight	606	622
112 1-1/2"	A03	Adams Rite® MS & DL3000	611	625
134 1-3/4"	A04	DL4000 Deadlock	612	626
	A05	Adams Rite® 4070	613	629
	A06 <sup>2</sup>	Schlage® L9000	613E	630
	A07	DL4100 Series Deadlock	618	722
	A62	Straight		
	A92	Exit Grip 01, 02		
	A93 <sup>1</sup>	For Obsolete Corbin® 610 Series and Russwin® 1403 Series Deadlock		
Cylinder Number			Price	
1037-114			\$207.00	

Notes:

1. Add \$2.00 per cylinder for A93 cam.
2. Add \$5.00 per cylinder for A06 cam.

**IC Rim**

7-Pin - No Cross Keying - Furnished standard with 422F88 surface mount collar unless otherwise indicated.

**Cylinder Number Example**

**3037 - 178 - 626**

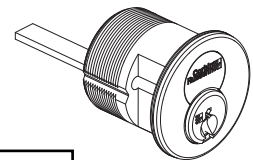

Tailpiece Length	Finish	
058 - 5/8"	605	619
114 - 1-1/4" M61 & M62 option for ED8200 and ED9200 exit device alarms	606	622
178 - 1-7/8"	611	625
	612	626
178V - 1-7/8" vertical	613	629
	613E	630
318 - 3-1/8"	618	722

Cylinder Number	Price
3037-_____	\$207.00

**Pyramid Core Only**

Cylinder Number	Price
8027	\$124.00

Note: For mortise and rim housing only, see page 91.

**Standard Mortise**

**Cylinder Number Example**

To simplify ordering, options designated "standard" may be omitted from the ordering sequence.

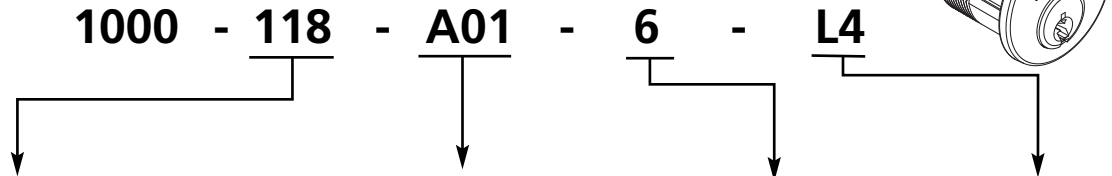

Length	Cam	Pins	Keyway
100	A01	5	L4
118	A02	6 (standard)	(standard)
114	A03	7	
138	A04		
112	A05		
134	A06 <sup>2</sup>		
200	A07		
	A62		
214	A92		
212	A93 <sup>1</sup>		
234			
300			
314			
312			
334			

Cylinder Number	Finish: 605, 606, 611, 612, 613, 613E, 618, 619, 622, 625, 626, 629, 630, 722	
	5- OR 6-PIN	7-PIN
1000-100-__-5 - Keyway	\$83.00	Not Available
1000-118-__-__ - Keyway		
1000-114-__-__ - Keyway		
1000-138-__-__ - Keyway	\$83.00	\$85.00
1000-112-__-__ - Keyway		
1000-134-__-__ - Keyway	\$93.00	\$95.00
1000-200-__-__ - Keyway		
1000-214-__-__ - Keyway		
1000-212-__-__ - Keyway	\$103.00	\$105.00
1000-234-__-__ - Keyway		
1000-300-__-__ - Keyway		
1000-314-__-__ - Keyway		
1000-312-__-__ - Keyway	\$113.00	Not Available
1000-334-__-__ - Keyway		

- Notes:  
 1. Add \$2.00 per cylinder for A93 cam.  
 2. Add \$5.00 per cylinder for A06 cam.

**Flexible Head Mortise**

**Cylinder Number Example**

To simplify ordering, options designated "standard" may be omitted from the ordering sequence.

**1100 - 118 - A01 - 6 - L4**



Length	Cam	Pins	Keyway
100 1" (6-pin standard)	A01 Cloverleaf (standard)	5	L4
118 1-1/8"	A02 Straight	6 (standard)	(standard)
114 1-1/4"		7	

Cylinder Number	Finish: 605, 606, 611, 612, 613, 613E, 618, 619, 622, 625, 626, 722	
	5- OR 6-PIN	7-PIN
1100-100-__ - __ - Keyway	\$156.00	Not Available
1100-118-__ - __ - Keyway		\$158.00
1100-114-__ - __ - Keyway	\$158.00	\$160.00

**Concealed Shell Mortise**

**Cylinder Number Example**

To simplify ordering, options designated "standard" may be omitted from the ordering sequence.

**1200 - 118 - A01 - 6 - L4**



Length	Cam	Pins	Keyways
100 1" (5-pin standard)	A01 Cloverleaf (standard)	5	L4
118 1-1/8" (6-pin standard)	A02 Straight	6 (standard)	(standard)
114 1-1/4"		7	
138 1-3/8"			
112 1-1/2"			

Cylinder Number	Finish: 606, 626	
	5- OR 6-PIN	7-PIN
1200-100-__ - 5 - Keyway	\$124.00	Not Available
1200-118-__ - __ - Keyway		
1200-114-__ - __ - Keyway		\$126.00
1200-138-__ - __ - Keyway		
1200-112-__ - __ - Keyway		



**Special Function Mortise**
**Hotel Function\* Cylinders**

To simplify ordering, you may specify only the first 4 digits (1001, 1101, 1201).

Cylinder Number	Description	Finish: 605, 606, 611, 612, 613, 613E, 618, 619, 625, 626, 629, 630, 722
1001-114-A01	Standard	\$120.00
1101-118-A01	Flex Head	\$144.00
1201-114-A01	Concealed Shell	\$134.00

Note: When ordering cylinders to accommodate the old Russwin® extra long EMK's in current ML2029 locks, specify A91 cam.  
\* Not available with D1, D2, L1, L2, 752, 852 or A class keyways.

**Brink Function Cylinders**

Cylinder Number	Description	Finish: 605, 606, 611, 612, 613, 613E, 618, 619, 625, 626, 629, 630, 722
1004-118-A02	Standard Clockwise	\$109.00
1005-118-A02	Standard Counter-Clockwise	
1004-118-A05	For Brink "CKS" Clockwise	
1005-118-A05	For Brink "CKS" Counter - Clockwise	

Note: For Security series, see page 94.

**Cylinder for Discontinued Exit Device**

Inside of Corbin® 3726-1/2, 3727-1/2 and Russwin® 736-1/2, 737-1/2

Cylinder Number	Finish: 605, 606, 611, 612, 613, 613E, 618, 619, 625, 626, 629, 630, 722
1006-118-A02	\$101.00

**Non-Keyed Mortise**
**Thumbturn Cylinders**

Cylinder Number	Description	Finish: 605, 606, 611, 612, 613, 613E, 618, 619, 625, 626, 629, 630, 722
1300-100-A02	Standard	\$83.00
1300-118-A02		
1300-114-A02	Standard	\$87.00
1300-138-A02		
1300-100-A03	Standard	\$83.00
1300-118-A03		
1300-114-A03	Standard	\$87.00
1300-138-A03		
1300-118-A93	Standard	\$85.00
1303-100-A03	Classroom	
1303-118-A03		
1303-114-A03	Classroom	\$89.00
1303-138-A03		

**Dummy Cylinders**

Cylinder Number	Finish: 605, 606, 611, 612, 613, 613E, 618, 619, 625, 626, 629, 630, 722
1400-118	\$70.00
1400-114	\$74.00
1400-138	\$78.00

**Rim Thumbturn Cylinders**

Cylinder Number	Finish: 605, 606, 611, 612, 613, 613E, 618, 619, 625, 626, 629, 630, 722
3300 -138	\$78.00
3300-138-M34	\$93.00
3300-200	\$78.00
3300-200-M34	\$93.00

**Rim (.552 dia. Plug)**

**Cylinder Number Example**

To simplify ordering, options designated "standard" may be omitted from the ordering sequence.

**3000 - 200 - 6 - L4**

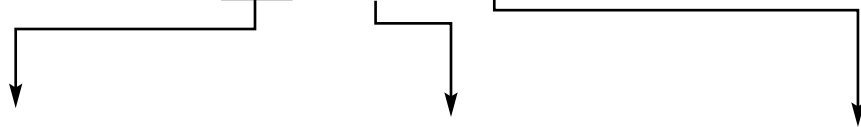
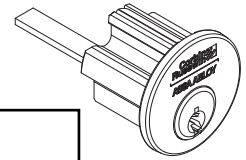

Tailpiece Length		Pins	Keyway
058	5/8"	5	L4 (Standard)
138	1-3/8" M61 & M62 option for ED8200 and obsolete ED9200 Exit Device Alarms	6 (Standard)	See page 61 for pricing of options.
		7	
200	2" (Standard)		
200N	2" ED4000/ED5000 Night Latch Function		
200V	2" Vertical		
312	3-1/2" (Thick door)		
312	3-1/2" (Thick door) Vertical		

Cylinder No.	Finish: 605, 606, 611, 612, 613, 613E, 618, 619, 622, 625, 626, 629, 630, 722	
	5- OR 6-PIN	7-PIN
3000-058      ___- Keyway		
3000-138      ___- Keyway		
3000-200-      ___- Keyway	\$83.00	\$85.00
3000-200N-    ___- Keyway		
3000-200V-    ___- Keyway		
3000-312-      ___- Keyway	\$85.00	\$87.00
3000-312V-    ___- Keyway		

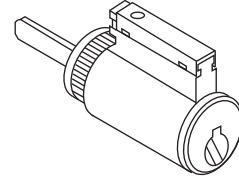
**Key-In-Lever/Knob (.509" plug)**

Cylinder Number		Finish: 606, 626		
		Series	6-PIN	7-PIN <sup>4</sup>
2000-031	Standard	CL3100, CK4300	\$76.00	\$78.00
2001-031 <sup>1</sup>	Hotel	CL3100	\$90.00	\$92.00
2400-031-C <sup>2</sup>	Schlage® C Keyway	CL3100	\$76.00	Not Available
2400-031-LA <sup>3</sup>	Sargent® LA Keyway	CL3100		
2000-033	Standard	CL3300, CL3500, CL3600, CL3800 <sup>B</sup>		\$78.00
2000-038	Standard	CL3800 <sup>A</sup>		
2001-034 <sup>1</sup>	Hotel	CL3300	\$90.00	\$92.00
2400-033-C <sup>2</sup>	Schlage® C keyway	CL3300, CL3500, CL3600, CL3800 <sup>B</sup>	\$76.00	Not Available
2400-033-LA <sup>3</sup>	Sargent® LA keyway			
2000-037	Standard	CL3700, CK4700		
2400-037-C <sup>2</sup>	Schlage® C keyway			
2400-037-LA	Sargent® LA keyway			
2000-039	Standard	CL3900	\$76.00	Not Available
2000-039L	2" to 2-1/4" Door			
2400-039-C <sup>2</sup>	Schlage® C keyway			
2400-039-LA <sup>3</sup>	Sargent® LA keyway			
2000-034	Standard	CL3400, CL3600 (Prior to June 2000)	\$76.00	\$78.00
2001-034 <sup>1</sup>	Hotel		\$90.00	\$92.00
2400-034-C <sup>2</sup>	Schlage® C keyway		\$76.00	Not Available
2400-034-LA <sup>3</sup>	Sargent® LA keyway			

**Notes:**

1. Not available in 752, 852 or A Class keyways.
  2. Available 0-bitted & keyed random only.
  3. Available 0-bitted only.
  4. For 7-pin version suffix "-7" to number. Not available in 752, 852 or A Class keyways.
- A. CL3800 manf. 1993-1997  
 B. CL3800 manf. 2006 -

**Cylindrical Deadlocks DL2200, DL3200 Series**

Cylinder Number		Door Thickness	Function	Finish: 606, 626 Price
4400-134-A51	6-Pin Conventional	All	11, 13, 17	\$76.00
4400-134-A52	6-Pin Conventional	1-3/8" to 1-3/4"	12	
4400-214-A52	6-Pin Conventional	2" to 2-1/4"	12	
4400-134-A51-7	7-Pin Conventional	All	11, 13, 17	\$78.00
4400-134-A52-7	7-Pin Conventional	1-3/8" to 1-3/4"	12	
4400-214-A52-7	7-Pin Conventional	2" to 2-1/4"	12	

**Key-In-Lever/Knob**
**For UT5200 & CK4200 Series Locksets (.552" dia plug)**

Cylinder Number	Description	Finish: 606, 626
2000-052	Standard	\$76.00
2001-052*	Hotel with Indicator	\$90.00
2100-052**	Discontinued Ronde & Continental Knob	\$90.00

**For CK4400 Series Locksets (.509" dia plug)**

Cylinder Number	Description	Finish: 606, 626
2000-044	All except below	\$76.00
2003-044	CK4455 & CK4482 before 8/93	
2001-044*	CK4429 with Indicator Pin New Style Straight Tailpiece	\$90.00
2001-066*	CK4429 with Indicator Pin Old Style Twisted Tailpiece	

**For G10 Exit Device Knob Trim**

Cylinder Number	Description	Finish: 606, 626
2000-033H	Standard	\$76.00

\* Not available with 752, 852 or A Class keyways.

\*\* Also available in 605, 611, 612, 613, 625 finishes. Not available with X Class keyways.

**For PL5000 Series Rekeyable Fixed Core Padlocks**

Cylinder Number	Description	Finish: 606, 626
2300	Standard 6-pin	\$76.00
2310	Security	\$181.00
2320	Pyramid High Security	\$158.00
2327	Pyramid Security	\$131.00

**For B2, G2, G3 Exit Device Trim**

Cylinder Number	Description	Finish: 606, 626
2000-051	Standard 6-pin	\$76.00

**Key-In-Lever/Knob (.552 dia Plug)**

For Other Manufacturers' Products

Cylinder Number	Description	Finish: 606, 626
2200-001-A21	Alarm Lock DL2500 Series	\$80.00
	Arrow® H Series Knobs and Levers	
	Arrow Q Series Levers	
	Sargent® 10 line (Enlarge Lever Hole)	
	Schlage® D Series Levers	
2200-001-A22	Schlage AL and ND Series Levers	
2200-002-A21	Schlage D Series Knobs	
2200-002-A23	Schlage A Series Knobs (ORB only)	
2200-002-A22	Schlage A Series Knobs (PLY, etc.)	
2200-003-A24	Lockwood® H Series Knobs (Enlarge Knob Hole)	
2200-008	Sargent 7, 8, 9 Line (Enlarge Knob Hole)	
2200-054	Yale® 5400, 6200 Knobs Only (Enlarge Knob Hole)	
2200-076	Sargent 7600 Integrallock	\$86.00

**For Adams Rite® 4025 Pull (.552" dia. Plug)**

Cylinder Number	Description	Finish: 606, 626
4200-003-A47	Cylinder & Housing	\$130.00
4200-002-A47	Cylinder Only	\$76.00

**IC Mortise**

For Construction Core Program, see page 63.  
For housing only, see page 91.

**Cylinder Number Example**

To simplify ordering, options designated "standard" may be omitted from the ordering sequence.

**1080 - 114 - A01 - 6 - L4**

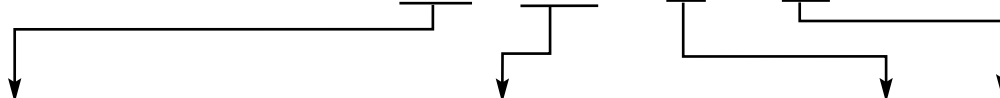
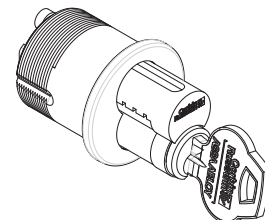

Length	Cam	Pins	Keyway
114 1-1/4" (6-pin standard)	A01 Cloverleaf (standard)	6 (standard)	L4 (standard)
138 1-3/8"	A02 Straight	7**	See page 61 for pricing of options.
112 1-1/2"	A03 Adams Rite® MS & DL300		
134 1-3/4"	A04 DL4000 Deadlock		
	A05 Adams Rite 4070		
	A06 <sup>2</sup> Schlage® L9000		
	A07 DL4100 Series Deadlock		
	A62 Straight		
	A92 Exit Group 01, 02		
	A93 <sup>1</sup> For obsolete Corbin® 610 Series and Russwin® 1403 Series Deadlocks		

Cylinder Number	Finish: 605, 606, 611, 612, 613, 613E, 618, 619, 622, 625, 626, 629, 630, 722	
	6-PIN	7-PIN
1080-114-	\$154.00	Not Available
1080-138-	\$157.00	Not Available
1080-112-__	\$157.00	\$161.00
1080-134-__	\$165.00	\$169.00

Notes:

- 1. Add \$2.00 per cylinder for A93 Cam.
- 2. Add \$5.00 per cylinder for A06 Cam.

**Hotel Function IC Mortise**

To simplify ordering, options designated "standard" may be omitted from the ordering sequence.

Cylinder Number	Finish: 605, 606, 611, 612, 613, 613E, 618, 619, 622, 625, 626, 629, 630, 722	
	6-PIN	7-PIN
1081-138-A01-6** (Hotel function uses E1-suffix EMK blank)	\$168.00	Not Available

- \*\* Not available with 752, 852 or A Class keyways.
- \*\* Only available in 1-1/2" and 1-3/4" length.

**IC Rim**

For Construction Core Program, see page 63.  
For housing only, see page 91.

**Cylinder Number Example**

To simplify ordering, options designated "standard" may be omitted from the ordering sequence.

**3080 - 178 - 6 - L4**

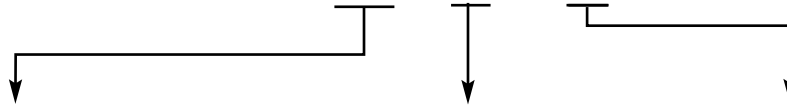
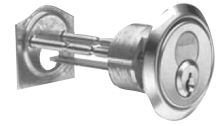

Tailpiece Length		Pins	Keyway
058	5/8" Tailpiece	6 Pin (standard)	L4 (standard)
178	1-7/8" (standard)	7 Pin	See page 61 for pricing of options
178V	1-7/8" Vertical		
318	3-1/8" (Thick door)		
114	1-1/4" M61 & M62 option for ED8200 and obsolete ED9200 exit device alarms		

Cylinder Number	Finish: 605, 606, 611, 612, 613, 613E, 618, 619, 622, 625, 626, 629, 630, 722	
	6 PIN	7 PIN
3080-058-	\$154.00	\$158.00
3080-178-__		
3080-178V-__		
3080-318-__	\$156.00	\$160.00
3080-114-__ (no back plate or screw)	\$156.00	\$160.00

**Core Only**



Cylinder Number (specify keyway)		Finish: 605, 606, 611, 612, 613, 613E, 618, 619, 622, 625, 626, 722
8000	6-Pin Standard	\$71.00
8000EMK*	6-Pin Standard set to hotel mortise EMK	
8000-7	7-Pin	\$73.00
8001-034*	6-Pin for CL3329, hotel indicator pin	\$87.00
8001-034-7*	7-Pin for CL3329, hotel indicator pin	\$89.00
8001-042*	6-Pin for CK4229, hotel indicator pin	\$87.00

\* Not available with 752, 852 or A Class keyways.  
Note: For uncombined cores suffix "UC". See page 48 for deduct.



**LFIC Mortise Housing Only**

**Housing Number Example**

To simplify ordering, options designated "standard" may be omitted from the ordering sequence.

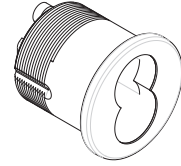

**1070 - 114 - A01 - 6**



Length	Cam		Pins
114 1-1/4" (6-pin standard)	A01	Cloverleaf (standard)	6 (standard)
138 1-3/8"	A02	Straight	7
112 1-1/2"	A03	Adams Rite® MS	
134 1-3/4"	A04	DL4000 Deadlock	
214 2-1/4"	A05	Adams Rite® 4070	
	A06 <sup>2</sup>	Schlage® L9000	
	A07	DL4100 Series Deadlock	
	A62	Straight	
	A92	Exit Group 01, 02	
	A93 <sup>1</sup>	For obsolete Corbin® 610 Series and Russwin® 1403 Series Deadlocks	

Cylinder Number	Finish: 605, 606, 611, 612, 613, 613E, 618, 619, 622, 625, 626, 629, 630, 722	
	6 PIN	7 PIN
1070-114-	\$83.00	Not Available
1070-138-	\$86.00	
1070-112-__-	\$86.00	\$88.00
1070-134-__-	\$94.00	\$96.00
1070-214-	\$100.00	Not Available
1071-138-A01 (Hotel function uses -E1 suffix EMK blank)	\$173.00	

**Notes:**

To simplify ordering, you may specify only "1071" since no length or cam variations exists.

1. Add \$2.00 per cylinder for A93 Cam.
2. Add \$5.00 per cylinder for A06 Cam.

**LFIC Rim Housing Only**

**3070 - 058 - 626**

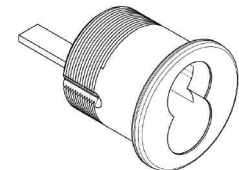
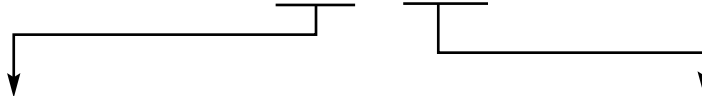

Cylinder Number	Finish : 605, 606, 611, 612, 613, 613E, 618, 619, 622, 625, 626, 629, 630, 722	
	6 PIN	7 PIN
3070-058- 5/8" tailpiece	\$83.00	\$85.00
3070-178-__ 1-7/8" tailpiece (standard)		
3070-178V-__ 1-7/8" vertical		
3070-318-__ 3-1/8" tailpiece (thick door)	\$85.00	\$87.00
3070-114-__ 1-1/4" tailpiece for M61, M62 exit alarm options. No back plate or screws.		

**SFIC Mortise Housing Only**

**Cylinder Number Example**

**1040 - 114 - A01 - 6**

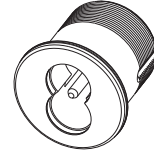

Length	Cam	Pins
114 1-1/4" (6-pin standard)	A01 Cloverleaf (standard)	6 (standard)
	A02 Straight	
	A03 Adams Rite® MS	
	A04 DL4000 Series Deadlock	
	A05 Adams Rite 4070	
	A06 Schlage® L9000	
	A07 DL4100 Series	
	A62 MR Straight	
	A93 Obsolete Deadlocks Corbin® 610 Series and Russwin® 1403 Series	
138 1-3/8" (7-pin standard) 112 1-1/2" (7-pin standard) 134 1-3/4" (7-pin standard)	A01 Cloverleaf (standard)	7
	A02 Straight	
	A03 Adams Rite® MS	
	A04 DL4000 Series Deadlock	
	A05 Adams Rite 4070	
	A06 Schlage® L9000	
	A07 DL4100 Series	
	A62 MR Straight	
	A93 Obsolete Deadlocks Corbin® 610 Series and Russwin® 1403 Series	

Cylinder Number	Finish: 605, 606, 611, 612, 613, 613E, 618, 619, 622, 625, 626, 629, 630, 722	
	6 PIN	7 PIN
1040-114-__-	\$83.00	Not Available
1040-138-__-	\$86.00	\$88.00
1040-112-__-	\$86.00	\$88.00
1040-134-__-	\$94.00	\$96.00

**SFIC Rim Housing Only**

**3040 - 058 - 626**

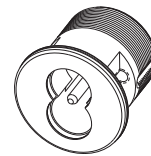

Cylinder Number	Finish : 605, 606, 611, 612, 613, 613E, 618, 619, 622, 625, 626, 629, 630, 722		
		6 PIN	7 PIN
3040-058- 5/8" tailpiece		\$83.00	\$85.00
3040-178-__ 1-7/8" tailpiece		\$83.00	\$85.00
3040-318-__ 3-1/8" tailpiece		\$85.00	\$87.00

**Standard Security Mortise**

For Existing Systems Only.\*  
For uncombined cylinders, suffix "UC".  
See page 48 for deduct.

6-Pin Only - No Cross Keying - Available in Z and DH Class Keyways only.  
Available UC or master keyed only.  
Not available KR or 0-bitted.

\* L4, D1 and 60 keyway sections may be ordered Keyed Random only, without prior Key Systems Administration approval

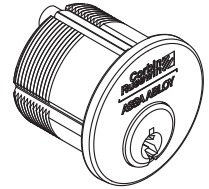

**Cylinder Number Example**

To simplify ordering, options designated "standard" may be omitted from the ordering sequence.

**1010 - 118 - A01 - L4**

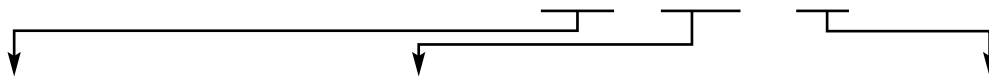

Length		Cam		Keyway
118	1-1/8" (standard)	A01	Cloverleaf (standard)	L4 (standard)
114	1-1/4"	A02	Straight	Available only with Z and DH Class keyways. See page 61 for pricing of options.
138	1-3/8"	A03	Adams Rite® MS & DL3000	
112	1-1/2"	A04	DL4000 Deadlock	
134	1-3/4"	A05	Adams Rite 4070	
200	2"	A06 <sup>2</sup>	Schlage® L9000	
214	2-1/4"	A07	DL4100 Series Deadlock	
		A62	Straight	
		A92	Exit Grip 01, 02	
212	2-1/2"	A93 <sup>1</sup>	For obsolete Corbin® 610 Series and Russwin® 1403 Series Deadlocks	
234	2-3/4"			

Cylinder Number	Finish: 605, 606, 611, 612, 613, 613E, 618, 619, 622, 625, 626, 629, 630, 722
1010-118-__	\$189.00
1010-114-__	
1010-138-__	\$197.00
1010-112-__	\$219.00
1010-134-__	\$229.00
1010-200-__	\$235.00
1010-214-__	\$241.00
1010-212-__	\$249.00
1010-234-__	\$253.00

Notes:

1. Add \$2.00 per cylinder for A93 Cam.
2. Add \$5.00 per cylinder for A06 Cam.

### Special Function Security Mortise

For Existing Systems Only.\*  
 6-Pin Only - No Cross Keying - Available in Z and DH Class Keyways only.  
 Available UC or master keyed only.  
 Not available KR or 0-bitted.  
 \* L4, D1 and 60 keyway sections may be ordered Keyed Random only, without prior Key Systems Administration approval

### Hotel Function Cylinders

Cylinder Number	Description	Finish: 605, 606, 611, 612, 613, 613E, 618, 619, 622, 625, 626, 629, 630, 722
1011-114-A01	1-1/4" Cloverleaf cam only	\$207.00

To simplify ordering, you may specify only "1011" since no length or cam variations exist.  
 For uncombined cylinders, suffix "UC". See page 48 for deduct.  
 Not available in D1, D2, L1 or L2 keyways.

### Blockout Function Cylinders

Cylinder Number	Description	Finish: 605, 606, 611, 612, 613, 613E, 618, 619, 622, 625, 626, 629, 630, 722
1012-114-A01	Cloverleaf	\$200.00
1012-114-A02	Straight	
1012-114-A03	DL3000 Series, Adams Rite® MS	
1012-114-A04	DL4000 Series Deadlock	
1012-114-A07	DL4100 Series Deadlock	
1012-114-A05	Adams Rite 4070	\$202.00
1012-114-A93	Obsolete Corbin® 610 Series and Russwin® 1403 Series Deadlock	

### Brink Function Cylinders

Cylinder Number	Description	Finish: 605, 606, 611, 612, 613, 613E, 618, 619, 622, 625, 626, 629, 630, 722
1014-118-A02	Standard Clockwise	\$193.00
1015-118-A02	Standard Counterclockwise	
1014-118-A05	For Brink "CKS" Clockwise	
1015-118-A05	For Brink "CKS" Counterclockwise	

**Security Rim**

For Existing Systems Only.\*

6-Pin Only - No Cross Keying - Available in Z and DH Class Keyways Only.  
Available UC or master keyed only. Not available KR or 0-bitted.

\* L4, D1 and 60 keyway sections may be ordered Keyed Random only, without prior Key Systems Administration approval

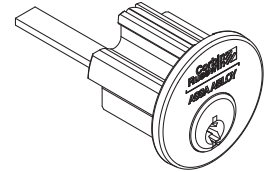

**Cylinder Number Example**

To simplify ordering, options designated "standard" may be omitted from the ordering sequence.

**3010 - 200 - L4**

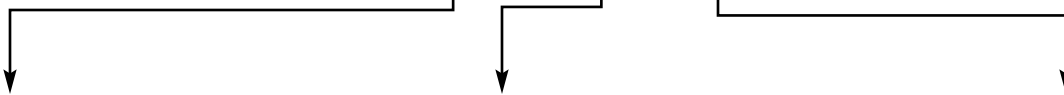

Function	Tailpiece Length	Keyway
<b>For 3010 Only:</b>	<b>For 3010 Only:</b>	L4 (standard) Available only with Z and DH Class keyways. See page 61 for pricing of options.
0 (standard)	200 2" (standard)	
2 Blockout	200V 2" vertical	
	312 3-1/2" (thick door)	
	312V 3-1/2" (thick door) vertical	
	058 5/8" Tailpiece	
	138 1-3/8" M61 and M62 option for ED8200 . . . . . and obsolete ED9200 exit device alarms	
	<b>For 3012 Only:</b>	
	178 1-7/8" (standard)	
	178V 1-7/8" vertical	
	318 3-1/8" (thick door)	
	318V 3-1/8" (thick door) vertical	

Cylinder Number	Finish: 605, 606, 611, 612, 613, 613E, 618, 619, 622, 625, 626, 629, 630, 722
3010-058-__	\$189.00
3010-200-__	
3010-200V-__	
3010-312-__	\$191.00
3010-312V-__	
3010-138-__ No back plate or screws	\$189.00
3012-178-__	\$197.00
3012-178V-__	
3012-318-__	\$199.00
3012-318V-__	

**Security Key-In-Lever/Knob**

For Existing Systems Only.\*  
6-Pin Only - No Cross Keying - Available in Z and DH Class Keyways Only.  
Available UC or master keyed only. Not available KR or 0-bitted.

\* L4, D1 and 60 keyway sections may be ordered Keyed Random only, without prior Key Systems Administration approval

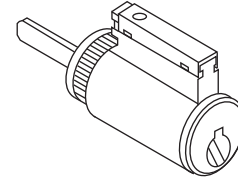

**For Key-In-Lever/Knob Trim (.552" plug)**

Cylinder Number	Series	Finish: 606, 626
2010-031	CL3100, CK4300	\$181.00
2010-033	CL3300, CL3500, CL3800 <sup>B</sup> , [CL3600 (June 2000 and after)]	
2010-034	CL3400, [CL3600 (prior to June 2000)]	
2010-038	CL3800 <sup>A</sup>	
2010-039	CL3900	
2010-039L	CL3900 ( 2 - 2-1/4" door)	
2010-052	CK4200, UT5200	
2011-042	CK4229 Hotel Function*	\$195.00
2010-051	B2, G2 Exit Device Knob Trim	\$181.00
4410-134-A51	DL2200, DL3200 Cylindrical Deadlock	\$181.00
4410-134-A52	DL2200, DL3200 Cylindrical Deadlock	\$181.00
4410-214-A52	DL2200, DL3200 Cylindrical Deadlock	\$181.00

For uncombined cylinders suffix "UC" - See page 48 for deduct.  
\*Not available with 752, 852, or A Class Keyways.

Notes: A CL3800 manf. 1993-1997  
B CL3800 manf. 2006 -

**For Other Manufacturers' Products (.552" plug)**

Cylinder Number	Series	Finish: 606, 626
2210-001-A21	Alarm Lock DL2500 Series	\$185.00
	Arrow® H Series Knobs and Levers	
	Arrow Q Series Levers	
	Sargent® 10 line (Enlarge Lever Hole)	
	Schlage® D Series Levers	
2210-001-A22	Schlage AL and ND Series Levers	
2210-002-A21	Schlage D Series Knobs	
2210-002-A23	Schlage A Series Knobs (ORB, only)	
2210-002-A22	Schlage A Series Knobs (PLY, ect)	
2210-003-A24	Lockwood® H Series Knobs (enlarge knob hole)	
2210-008	Sargent 7, 8, 9 Line (enlarge knob hole)	
2210-054	Yale® 5400, 6200 Knobs only (enlarge knob hole)	

**IC Mortise**

For Existing Systems Only.\*  
For Construction Core Program, see page 63. For housing only, see page 91.

6-Pin Only - No Cross Keying - Available in Z and DH Class Keyways Only.  
Available UC or master keyed only. Not available KR or 0-bitted.

\* L4, D1 and 60 keyway sections may be ordered Keyed Random only, without prior Key Systems Administration approval

**Cylinder Number Example**

To simplify ordering, options designated "standard" may be omitted from the ordering sequence.

**1090 - 114 - A01- L4**

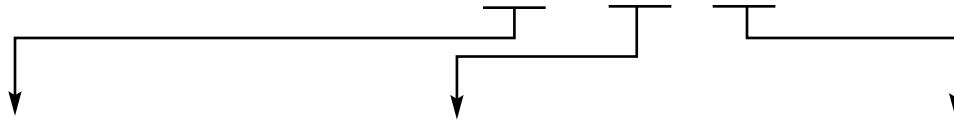
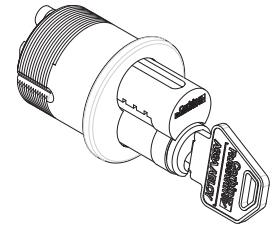

Length	Cam	Keyway
114 1-1/4" (standard)	A01 Cloverleaf (standard)	L4 (standard) Available only with Z and DH Class keyways. See page 61 for pricing of options.
138 1-3/8"	A02 Straight	
112 1-3/8"	A03 Adams Rite® MS & DL3000	
134 1-3/4"	A04 DL4000 Deadlock	
	A05 Adams Rite 4070	
	A06 <sup>2</sup> Schlage® L9000	
	A07 DL4100 Series Deadlock	
	A62 Straight	
	A92 Exit Grip 01, 02	
	A93 <sup>1</sup> For obsolete Corbin® 610 Series and Russwin® 1403 Series Deadlocks	

Cylinder Number	Finish: 605, 606, 611, 612, 613, 613E, 618, 619, 622, 625, 626, 629, 630, 722
1090-114-	\$259.00
1090-138-	\$262.00
1090-112-	
1090-134-	\$270.00

- Notes:  
1. Add \$2.00 per cylinder for A93 Cam.  
2. Add \$5.00 per cylinder for A06 Cam.

**Hotel Function IC Mortise**

Cylinder Number	Finish: 605, 606, 611, 612, 613, 613E, 618, 619, 622, 625, 626, 629, 630, 722
1091-138-A01 Hotel function uses - E1 suffix EMK blank	\$273.00

To simplify ordering, you may specify only "1091" since no length or cam variations exist.

**IC Rim**

For Existing Systems Only.\*  
 For Construction Core Program, see page 63.  
 For housing only, see page 91.  
 6-Pin Only - No Cross Keying - Available in Z and DH Class Keyways Only. Available UC or master keyed only. Not available 0-bitted.  
 \* L4, D1 and 60 keyway sections may be ordered Keyed Random only, without prior Key Systems Administration approval

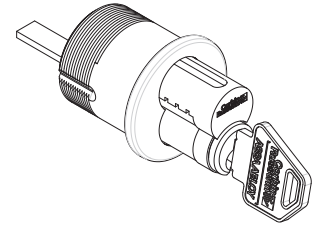

**Cylinder Number Example**

To simplify ordering, options designated "standard" may be omitted from the ordering sequence.

**3090 - 178 - L4**

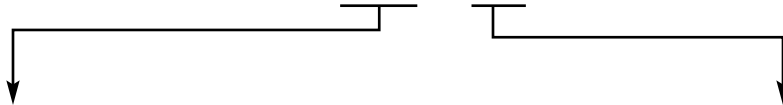

Tailpiece Length		Keyway
058	5/8" Tailpiece	L4 (standard). Available only with Z and DH Class keyways. See page 61 for pricing of options.
178	1-7/8" (standard)	
178V	1-7/8" (standard) vertical	
318	3-1/8" (thick door)	
114	1-1/4" for M61 and M62 option alarmed exit devices	

Cylinder Number	Finish: 605, 606, 611, 612, 613, 613E, 618, 619, 622, 625, 626, 629, 630, 722
3090-058	\$259.00
3090-178	
3090-178V	
3090-318	\$261.00
3090-114 No back plate or screws	\$261.00

**Security Core Only**

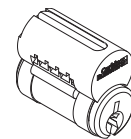

Cylinder Number	Finish: 605, 606, 611, 612, 613, 613E, 618, 619, 622, 625, 626, 722
8010 6-pin standard	\$176.00
8010EMK 6-pin standard set to hotel mortise EMK	
8011-042 6-pin for CK4229, hotel indicator pin	\$190.00

For uncombined cores, suffix "UC," see page 48 for deduct.



**Standard Master Ring Mortise**

**Cylinder Number Example**

To simplify ordering, options designated "standard" may be omitted from the ordering sequence.

**1060 - 118 - A61 - 6 - L4**

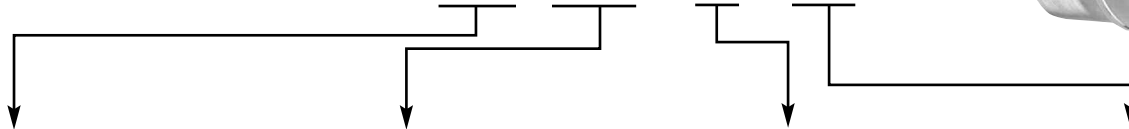

Length	Cam	Pins	Keyway
100 1" (5-pin only)	A61 New Cloverleaf (standard) (for locks made after 5/93; requires thumbturn hub 562F41-2)	5	L4 (standard) See page 61 for pricing of options.
118 1-1/8" (std)	A62 Straight	6 (standard)	
114 1-1/4"	A63* Large Short	7 (optional for 1-3/8" only)	
138 1-3/8"	A64* Large Long		
134 1-3/4"	A65* Old Cloverleaf (formerly 11A)		
112 1-1/2"			
200 2"			
214 2-1/4"			
212 2-1/2"			
234 2-3/4"			
300 3"			

Cylinder Number	Finish: 605, 606, 611, 612, 613, 613E, 618, 619, 622, 625, 626, 722
1060-100-__-5	\$128.00
1060-118-__-__	
1060-114-__-__	
1060-138-__-__	\$138.00
1060-112-__-__	
1060-134-__-__	
1060-200-__-__	\$148.00
1060-214-__-__	
1060-212-__-__	
1060-234-__-__	
1060-300-__-__	

\*Add \$2.00 per cylinder for A63, A64 and A65 Cam.

**Flexible Head Master Ring Mortise**

**Cylinder Number Example**

To simplify ordering, options designated "standard" may be omitted from the ordering sequence.

**1160 - 118 - A61 - 6 - L4**

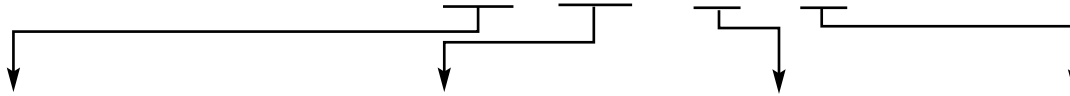

Length	Cam	Pins	Keyway
100 1" (6-pin std)	A61 New Cloverleaf (standard) (for locks made after 5/93; requires thumbturn hub 562F41-2)	5	L4 (standard) See page 61 for pricing of options.
118 1-1/8"		6 (standard)	
114 1-1/4"			
	A62 Straight		
	A63* Large Short		
	A64* Large Long		
	A65* Old Cloverleaf (formerly 11A)		

Cylinder Number	Finish: 605, 606, 611, 612, 613, 613E, 618, 619, 622, 625, 626, 722
1160-100-__-__	\$166.00
1160-118-__-__	
1160-114-__-__	

\* Add \$2.00 per cylinder for A63, A64 or A65 Cam.

**Dummy Master Ring Mortise Cylinders**

Cylinder Number	Finish: 605, 606, 611, 612, 613, 613E, 618, 619, 622, 625, 626, 722
1460-118	\$120.00
1460-114	
1460-138	
1460-112	

**Master Ring Rim**

Cylinder Number (Specify Keyway)		Finish: 605, 606, 611, 612, 613, 613E, 618, 619, 622, 625, 626, 722
3060-200	Standard horizontal tailpiece	\$128.00
3060-312	Thick door, horizontal tailpiece	
3060-200V	Vertical tailpiece	
3060-312V	Thick door, vertical tailpiece	

**For CK4200 & UT5200 Series Locksets (.552" dia. plug)**

Cylinder Number		Finish: 606, 626
2060-052	Standard	\$108.00
2061-042*	CK4229 Hotel with indicator pin	\$134.00
2160-052**	Discontinued Ronde and Continental Knob	\$118.00

\* Not Available with 752, 852 or A Class keyways.  
 \*\* Also Available in 605, 611, 612, 613, 625 finishes.  
 Not Available with X Class and certain restricted keyways.

**Master Ring Special Applications For Exit Device Operators (.552" plug)**

Cylinder Number		Finish: 606, 626
4266-001-A02	ED6800 x B5 or B6 trim	\$122.00
	ED7400 x 03 or 04 trim	
4266-001-A92	ED6800 x 01 or 02 trim	

**Pin Kits**

Description	Catalog Number	Part Number	Price
Corbin Russwin System 70 and Pre-System 70, 752, 852 and A Class keyways Not for System 70 Security	PK-1070	610F53-8	\$867.00
Corbin® Z Class and Russwin® DH Class keyways System 70, all cylinders except Security	PK-70-ZDH	602F12-9	\$578.00
Russwin N Class System, all cylinders	PK-70-N	602F11-9	\$451.00
Corbin X Class, all cylinders	PK-70-X	602F10-9	\$441.00
Pyramid High Security cylinders	PK-20-HS	694F96-8	\$1,189.00
Pyramid Security cylinders	PK-20-PS	715F96-8	\$878.00
Security cylinders, including interchangeable core, blockout and Brink	PK-70-HS	610F52-9	\$1,638.00
Access 3 Key System AP only	PK-30-AP	763F088	\$845.00
Access 3 Key System - AP, AS, AHS	PK-30-MASTER	763F098	\$1,231.00

**Tools**

Description	Catalog Number	Part Number	Price
Tool kit - contains 1 each: CT-4, CT-11, CT-19, CT-21, CT-22, CT-23, CT-26, CT-54	CT-93	612F58-8	\$287.00
Plug follower, .509" brass	CT-4	073F99-2	\$28.00
Pin chamber reamer	CT-5	239F75-8	\$78.00
Pin chamber burring tool	CT-7	382F18-8	\$206.00
Loading tool for .509" shell	CT-10	577F49-9	\$78.00
Key gauge, all Corbin® key classes	CT-11	239F37-7	\$28.00
Tweezers (was CT-6)	CT-19	239F36-8	\$33.00
Plug follower, .496	CT-20	694F97-2	\$14 (order in mult.of 10)
Key gauge, Pyramid	CT-20K	698F36-7	\$28.00
Key gauge, Access 3	CT-30K		
Key gauge, Russwin® N	CT-21	603F27-7	
Key gauge, Russwin® D & H	CT-22	604F19-7	
Key gauge, Russwin® 981/852	CT-23	604F18-7	
Plug follower, .552" brass	CT-54	073F98-2	\$35.00
IC mortise cylinder installation wrench	CT-80	363F61-2	\$48.00
Follower, disposable, .509" plug		484F72-9	\$1.00 (order in mult. Of 50)
Follower, disposable, .552" plug		484F73-9	\$0.50 (order in mult. Of 100)



Look for the  *MicroShield* icon.

**MicroShield®**

As part of their promise to provide innovative solutions to their customers, certain ASSA ABLOY Group brands offer the MicroShield® technology, a silver-based antimicrobial coating designed to inhibit the growth of bacteria.

MicroShield® is a registered trademark of Yale Security Inc., an ASSA ABLOY Group company.

Product	Series	MicroShield® Coated Components
Access 800®	All	Levers* and escutcheons

**AVAILABLE FINISHES**

- MicroShield® is available on 626 and 630. Other finishes available by Special Product Application Request Form only.
- Specify 626C (satin chrome plated) or 630C (satin stainless steel) when ordering.
- MicroShield® coating will be applied over 626 and 630 finishes. All components will match 626.

*Note: MicroShield® coating will only be applied to "high touch" components.*

Description	Add
Mortise Locks	Add \$62.00
Cylindrical Locks	Add \$62.00
Exit Devices & Outside Trims (ordered together)	Add \$76.00 (when ordered together)
Exit Devices & Trims (ordered separately)	Add \$62.00

**ML20800 Mortise  
Standard Features**

**Handing**

Handed; quick reversible

**Door Thickness**

1-3/4"

**Backset**

2-3/4" Standard

**Strike**

ANSI straight lip  
4-7/8" x 1-1/4" x 1-1/8"

**Cylinder**

1000-138-A01, 6-pin, L4, keyed random,  
finished standard for 1-3/4" door

**Keys**

Two nickel silver standard

**Weight**

11 lbs

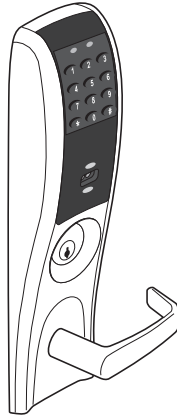

**ML20800 Mortise Lock Ordering Examples**

**Stock Order**

Quantity	Series/Function	Technology Code	Trim	Finish	Hand	Credential Quick Code
24	ML20834	TCAC2	LSZ	626	RHR	M803

**Split Trim/Finish Order**

Quantity	Series/Function	Technology Code	Trim		Finish		Hand	Credential Quick Code
			Outside	Inside	Outside	Inside		
24	ML20834	TCAC2	LSZ	CSZ	626	606	RHR	M803

**Contract/Detailed Order**

Quantity	Keypad	Series/Function	Technology Code	Trim	Finish	Hand	Door Thickness	Optional Strike	Credential Quick Code	Optional Cylinder	Keying
24	AA1	ML20834	TCAC2	LSZ	626	RHR	D214	SA200	M803	C7	VKC3

**Lever Design: ASZ, CSZ, DSZ, ESZ, LSZ, NSZ, PSZ, RSZ**

**Lever:** Cast    **Escutcheon:** Zinc Die Cast

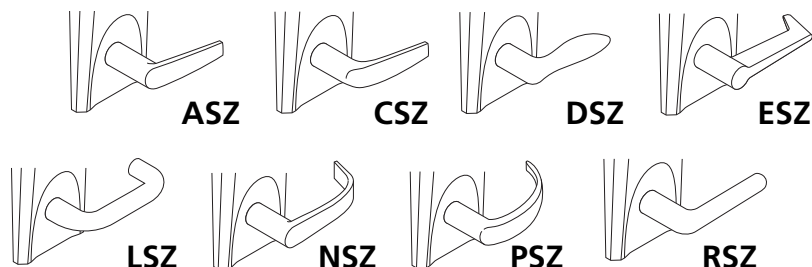

**Lever Design: FSZ, MSZ, TSZ, ZSZ**

**Lever:** Cast    **Escutcheon:** Zinc Die Cast



Function	Description	ASZ, CSZ, DSZ, ESZ, LSZ, NSZ, PSZ, RSZ		FSZ, MSZ, TSZ, ZSZ	
		Finish: 613E, 626	Finish: 605, 606, 611, 612, 613, 613L, 618, 619, 625, 630, 722	Finish: 613E, 626	Finish: 605, 606, 611, 612, 613, 613L, 618, 619, 625, 722
ML20833	Without key override x M800	\$1,111.00	\$1,213.00	\$1,111.00	\$1,213.00
ML20834	With key override x M800	\$1,194.00	\$1,296.00	\$1,194.00	\$1,296.00
ML20835	Deadbolt without key override x M800	\$1,125.00	\$1,227.00	\$1,125.00	\$1,227.00
ML20836	Deadbolt with key override x M800	\$1,208.00	\$1,310.00	\$1,208.00	\$1,310.00
ML20837*	Dormitory Entry with Deadbolt and inside leverswitch x M802	\$1,795.00	\$1,897.00	\$1,795.00	\$1,897.00
	Dormitory Entry with Deadbolt and inside leverswitch x M803	\$1,860.00	\$1,962.00	\$1,860.00	\$1,962.00

**Access 800® Options**

Description	Specify	Add
100 User, keypad only	M800	No Charge
2000 User, keypad only	M801	\$155.00
2000 User, proximity only	M802	\$587.00
2000 User, keypad and proximity	M803	\$652.00
2000 User, keypad and RF actuation**	M804	\$369.00
2000 User, proximity and RF actuation**	M805	\$801.00
2000 User, keypad, proximity and RF actuation**	M806	\$865.00

\* ML20837 only compatible with proximity readers, M802 and M803

\*\* Note: RF Fob must be ordered separately. See page 104.

**Mortise Lockset ML20800 Series Cylinder Options**

For Key Override function only

Description	Specify	Add or Deduct
Conventional 6-pin	(standard)	No Charge
Conventional 7-pin	7P	Add \$2.00 per cylinder
Less Standard Cylinder	LC	Deduct \$83.00 per cylinder
Access 3 Patented	AP	No Charge
Access 3 Security	AS	Add \$54.00 per cylinder
Access 3 High Security, UL 437	AHS	Add \$76.00 per cylinder
Access 3 IC Patented	ACP	Add \$71.00 per cylinder
Access 3 IC Security	ACS	Add \$120.00 per cylinder
Access 3 IC High Security, UL 437	ACHS	Add \$140.00 per cylinder
Pyramid Security Fixed Core	PS	Add \$55.00 per cylinder
Pyramid Security IC	PCS	Add \$124.00 per cylinder
Pyramid High Security Fixed Core	PHS	Add \$82.00 per cylinder
Pyramid High Security IC	PCHS	Add \$152.00 per cylinder
Pyramid IC with Temporary Construction Core	CTP	Add \$71.00 per cylinder
Pyramid IC with Temporary Disposable Core	CTPD	No Charge
Pyramid IC Less Core	CLP	No Charge
Security	HS	Add \$106.00 per cylinder
Security IC	CHS	Add \$176.00 per cylinder
IC 6-pin	C6	Add \$71.00 per cylinder
IC 6-pin with Temporary Construction Core (Red)	CT6R	Add \$71.00 per cylinder
IC 6-pin with Temporary Construction Core (Blue)	CT6B	Add \$71.00 per cylinder
IC 6-pin with Temporary Construction Core (Green)	CT6G	Add \$71.00 per cylinder
IC 6-pin with Temporary Disposable Core	CT6D	No Charge
IC 6-pin Less Core	CL6	No Charge
SFIC 6-pin with Less Core	CLS6	No Charge
IC 6-pin with SFIC disposable temporary core	CT6SD	No Charge
IC 7-pin	C7	Add \$73.00 per cylinder
IC 7-pin with Temporary Construction Core (Red)	CT7R	Add \$73.00 per cylinder
IC 7-pin with Temporary Construction Core (Blue)	CT7B	Add \$73.00 per cylinder
IC 7-pin with Temporary Construction Core (Green)	CT7G	Add \$73.00 per cylinder
IC 7-pin with Temporary Disposable Core	CT7D	Add \$2.00 per cylinder
IC 7-pin Less Core	CL7	Add \$2.00 per cylinder
SFIC 7-pin with Less Core	CLS7	Add \$2.00 per cylinder
IC 7-pin with SFIC disposable temporary core	CT7SD	Add \$2.00 per cylinder

**Keying Options\***

Description	Specify	Add or Deduct
0-Bitted with 2 blank keys	(standard)	No Charge
Keyed random	KR	No Charge
Construction master keyed <sup>1,2</sup>	CMK	Add \$16.00 per cylinder
Visual key control (VKC)		
- No Stamping	VKC0	\$4.50
- Keys only	VKC1	No Charge
- Cylinders and Keys <sup>3</sup>	VKC2	\$8.00
- Cylinders only <sup>3</sup>	VKC3	\$8.00
Concealed key control (CKC)		
- CKC cylinders with VKC keys	CKC2	\$8.00
- CKC cylinders only <sup>3</sup>	CKC3	\$8.00
More than 2 keys per lock	KY# (e.g., KY6)	See page 66 - Cut Keys Section

\*For key bows other than 10 and 90, specify "KB" + bow number as Quick Code, e.g. KB12.

Notes:

1. CMK Construction master keying charge is in addition to master keying charge.
2. CMK Construction master keying is not available in Pyramid or Security series.
3. VKC2, VKC3, CKC3 are not available in Pyramid or Security series.



**Door Thickness**

Description	Specify	Add or Deduct
1-3/4"	(standard)	No Charge
2"	D200	
2-1/4"	D214	

**Strike Options\***

(To purchase strike separately, see catalog or parts manual for part no.)

Lip Length	ANSI Straight Lip - Specify	ANSI Curved Lip - Specify	Add or Deduct
7/8"	SS078	N/A	No Charge
1-1/8"	(standard)	N/A	
1-1/4"	SS114	SA114	
1-3/8"	SS138	SA138	
1-1/2"	SS112	SA112	
1-3/4"	SS134	SA134	Add \$16.00 per lockset
2"	SS200	SA200	
2-1/4"	SS214	SA214	
2-1/2"	SS212	SA212	
2-3/4"	SS234	SS234	
3"	SS300	SA300	

Description	Door Thickness	Specify	Add or Deduct
Open Back Strike	1-3/4"	SB134	Add \$82.00 per lockset
Open Back Strike	2"	SB200	Add \$124.00 per lockset
Open Back Strike	2-1/4"	SB214	
Rabbeted front and strike		SR118	Add \$86.00 per lockset

\* If door thickness is standard or has been specified and no special door or frame condition exists, then only the first two characters of the optional strike Quick Code must be specified (e.g. "SA").

The correct lip length will be determined by our order entry system based on the standard or specified door thickness.

**Miscellaneous Options**

Description	Specify	Add or Deduct
Torx® head screws	M04	Add \$22.00 per lockset
ANSI wrought strike box	M17	No Charge
Knurling outside and inside <sup>1</sup>	M20	Add \$132.00 per lockset
Knurling outside only <sup>1</sup>	M21	Add \$66.00 per lockset
Knurling inside only	M22	Add \$66.00 per lockset
Abrasive coat outside and inside <sup>1</sup>	M23	Add \$82.00 per lockset
Abrasive coat inside only <sup>1</sup>	M24	Add \$41.00 per lockset
Abrasive coat outside only	M25	Add \$41.00 per lockset
Power/Remote Unlocking Harness	M35	Add \$47.00 per lockset
Forced/Propped Door <sup>2</sup>	M861	Add \$12.50 per lockset

Notes:

1. Not available with Vineyard™ or Muséo® levers.
2. Not compatible with M800

**CL33800 Cylindrical  
Standard Features**

**Handing**

Non-handed

**Door Thickness**

1-3/4" - 2"

**Backset**

2-3/4" Standard

**Strike**

ANSI curved lip

4-7/8" x 1-1/4" x 1-1/4"

**Cylinder**

6-pin, L4, keyed random,  
0-bitted standard

**Keys**

Two nickel silver standard

**Weight**

9.5 lbs

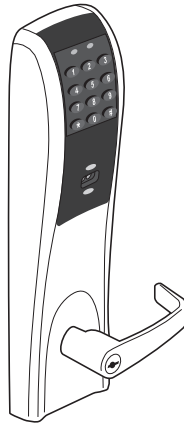

**CL33800 Cylindrical Lock Ordering Examples**

**Stock Order**

Quantity	Series/ Function	Technology Code	Trim	Finish	Hand	Credential Quick Code
100	CL33834	TCAC2	NZZ	626	RHR	M803

**Split Trim/Finish Order**

Quantity	Series/ Function	Technology Code	Trim		Finish		Hand	Credential Quick Code
			Outside	Inside	Outside	Inside		
12	CL33834	TCAC2	NZZ	AZZ	626	625	LH	M803

**Contract/Detailed Order**

Quantity	Keypad	Series/ Function	Technology Code	Trim	Finish	Hand	Door Thickness	Backset	Optional Strike	Credential Quick Code	Optional Cylinder	Keying
24	AA1	CL33834	TCAC2	NZZ	626	RHR	D214	B334	SC114	M802	C6	VKC3

**Lever Design: AZZ, NZZ, PZZ**

**Lever:** Zinc Die Cast

**Escutcheon:** Zinc Die Cast

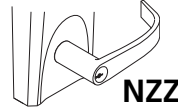
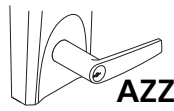

Function	Description	AZZ, NZZ, PZZ, FZZ	
		Finish: 613E, 626	Finish: 611, 605, 606, 612, 613, 613L, 618, 619, 625, 722
CL33834	With key override x M800	\$1,078.00	\$1,173.00

**Access 800® Options**

Description	Specify	Add
100 User, keypad only	M800	No Charge
2000 User, keypad only	M801	\$155.00
2000 User, proximity only	M802	\$587.00
2000 User, keypad and proximity	M803	\$652.00
2000 User, keypad and RF actuation*	M804	\$369.00
2000 User, proximity and RF actuation*	M805	\$801.00
2000 User, keypad, proximity and RF actuation*	M806	\$865.00

\* Note: RF Fob must be ordered separately. See page 104.

**Cylindrical Lockset CL33800 Series Cylinder Options**

Description	Specify	Add or Deduct
Conventional 6-pin	(standard)	No Charge
Conventional 7-pin	7P	Add \$2.00 per cylinder
Less Standard Cylinder	LC	Deduct \$76.00 per cylinder
Access 3 Patented	AP	No Charge
Access 3 Security	AS	Add \$54.00 per cylinder
Access 3 High Security, UL 437	AHS	Add \$76.00 per cylinder
Access 3 IC Patented	ACP	Add \$71.00 per cylinder
Access 3 IC Security	ACS	Add \$120.00 per cylinder
Access 3 IC High Security, UL 437	ACHS	Add \$140.00 per cylinder
Pyramid Security Fixed Core	PS	Add \$55.00 per cylinder
Pyramid Security IC	PCS	Add \$124.00 per cylinder
Pyramid High Security Fixed Core	PHS	Add \$82.00 per cylinder
Pyramid High Security IC	PCHS	Add \$152.00 per cylinder
Pyramid IC Less Core	CLP	No Charge
Security	HS	Add \$105.00 per cylinder
Security IC	CHS	Add \$176.00 per cylinder
IC 6-pin	C6	Add \$71.00 per cylinder
IC 6-pin with Temporary Construction Core (Red)	CT6R	Add \$71.00 per cylinder
IC 6-pin with Temporary Construction Core (Blue)	CT6B	Add \$71.00 per cylinder
IC 6-pin with Temporary Construction Core (Green)	CT6G	Add \$71.00 per cylinder
IC 6-pin with Temporary Disposable Core	CT6D	No Charge
IC 6-pin Small Format Disposable Core	CTSD	No Charge
IC 6-pin Less Core	CL6	No Charge
IC 7-pin	C7	Add \$73.00 per cylinder
IC 7-pin with Temporary Construction Core (Red)	CT7R	Add \$73.00 per cylinder
IC 7-pin with Temporary Construction Core (Blue)	CT7B	Add \$73.00 per cylinder
IC 7-pin with Temporary Construction Core (Green)	CT7G	Add \$73.00 per cylinder
IC 7-pin with Temporary Disposable Core	CT7D	No Charge
IC 7-pin Less Core	CL7	No Charge
Lockset furnished in Schlage® C Keyway <sup>1</sup>	C	No Charge
Lockset furnished in SARGENT® LA Keyway <sup>2</sup>	LA	No Charge

**Keying Options\***

Description	Specify	Add or Deduct
0-Bitted with 2 blank keys	(standard)	No Charge
Keyed random	KR	No Charge
Construction master keyed <sup>1, 2</sup>	CMK	Add \$16.00 per cylinder
Visual key control (VKC)		
- No Stamping	VKC0	\$4.50
- Keys only	VKC1	No Charge
- Cylinders and Keys <sup>3</sup>	VKC2	\$8.00
- Cylinders only <sup>3</sup>	VKC3	\$8.00
Concealed key control (CKC)		
- CKC cylinders with VKC keys	CKC2	\$8.00
- CKC cylinders only <sup>3</sup>	CKC3	\$8.00
More than 2 keys per lock	KY# (e.g., KY6)	See page 66 - Cut Keys Section

\*For key bows other than 10 and 90, specify "KB" + bow number as Quick Code, e.g. KB12.

Notes:

1. CMK Construction master keying charge is in addition to master keying charge.
2. CMK Construction master keying is not available in Pyramid or Security series.
3. VKC2, VKC3, CKC3 are not available in Pyramid or Security series.

**Door Thickness Options**

Description	Specify	Add or Deduct
1-3/4"	(standard)	
2"	D214	Add \$6.00 per lockset

**Backset Options**

Description	Specify	Add or Deduct
2-3/4"	(standard)	No Charge
3-3/4"	B334	Add \$15.00 to lockset
5"	B500	Add \$24.00 to lockset

**Strike Options\***

(To purchase strike separately, see catalog or parts manual for part no.)

Lip Length	ANSI Straight Lip - Specify	ANSI Curved Lip - Specify	Add or Deduct
1"	SA100	SC100	No Charge
1-1/8"	SA118	SC118	
1-1/4"	(standard)	SC114	
1-3/8"	SA138	SC138	
1-1/2"	SA112	SC112	
1-3/4"	SA134	SC134	Add \$16.00 per lockset
2"	SA200	SC200	
2-1/4"	SA214	SC214	
2-1/2"	SA212	SC212	
2-3/4"	SA234	SC234	
3"	SA300	SC300	
Rabbeted front and strike		SR118	Add \$86.00 per lockset

\*If door thickness is standard or has been specified and no special door or frame condition exists, then only the first two characters of the optional strike Quick Code must be specified (e.g. "SC").  
 The correct lip length will be determined by our order entry system based on the standard or specified door thickness.

**Miscellaneous Options**

Description	Specify	Add or Deduct
Torx® head screws	M04	Add \$22.00 per lockset
Less cylinder, with tailpiece for Schlage® cylinder	M06	No Charge
Lever to accept Best® type core (NZD & PZD designs only)	M08	No Charge
Lever to accept Sargent® cylinder (NZD & PZD design only)	M09	No Charge
Rounded corners on latch front	M13	Add \$2.50 per latch
3/4" (19mm) throw fire latch	M16	Add \$100.00 per lockset
ANSI wrought strike box	M17	No Charge
Knurling outside and inside	M20	Add \$132.00 per lockset
Knurling outside only	M21	Add \$66.00 per lockset
Knurling inside only	M22	Add \$66.00 per lockset
Abrasive coat outside and inside	M23	Add \$82.00 per lockset
Abrasive coat inside only	M24	Add \$41.00 per lockset
Abrasive coat outside only	M25	Add \$41.00 per lockset
Power/Remote Unlocking Harness	M35	Add \$47.00 per lockset
Lever to accept Schlage® interchangeable core (NZD & PZD design only)	M69	No Charge
Forced door/propped door <sup>2</sup>	M861	Add \$12.50 per lockset

Notes: 2. Not compatible with M800

**ED5000 Exit Devices**  
**Standard Features**

**Handing**

Device non-handed; lever trim is handed

**Door Thickness**

1-3/4" Standard

**Stile**

4-1/2" Minimum width

**Strike**

Rim Device: Surface mounted 3/8" diameter roller strike

Mortise Device: ANSI curved lip strike

**Projection**

3-1/4" active, 2-3/4" dogged

**Trim**

Cylinder is not included. See page 99 for Cylinder options.

**Weight**

8.5 lbs



**ED5000 Series Exit Devices Ordering Examples**

**Exit Device Only**

Quantity	Series/Function	Finish	Hand	Misc. Options
24	ED5200S	626	RHR	M51-M54

**Trim Only**

Quantity	Trim/Function	Technology Code	Finish	Hand	Credential Quick Code
24	N9M833	TCAC2	625	RHR	M800

**Exit Device with Trim**

Quantity	Exit Device	Trim/Function	Technology Code	Finish	Hand	Cylinder Option	Door Thickness	Optional Strike	Door Width	Misc. Options	Credential Quick Code
65	ED5634L	N9M834	TCAC2	605	LHR	6P	D200	SB134	W048	M51-M54 & M800	M800

**Contract/Detailed Order - Rim Exit Device with Trim**

Quantity	Keyset	Exit Device	Trim/Function	Technology Code	Finish	Hand	Door Width	Credential Quick Code	Cylinder Option
36	AA1	ED5200	C9834	TCAC2	626	LHR	W048	M804	79

**Removable Mullion**

Quantity	Mullion	Misc. Options
24	908A	M57

**Mortise Exit Only**

Trim Type	Function	Panic	Fire
Lever	Entry without key override	ED5600L	ED5600AL
Lever	Entry with key override	ED5634L	ED5634AL

**ED5200(S)(A) Rim/SecureBolt® Device**  
**Lever Design: A, C, D, E, L, N, PR, R**

**Lever:** Cast      **Keypad/Controller Escutcheon:** Zinc Die Cast  
**Trim Escutcheon:** Forged

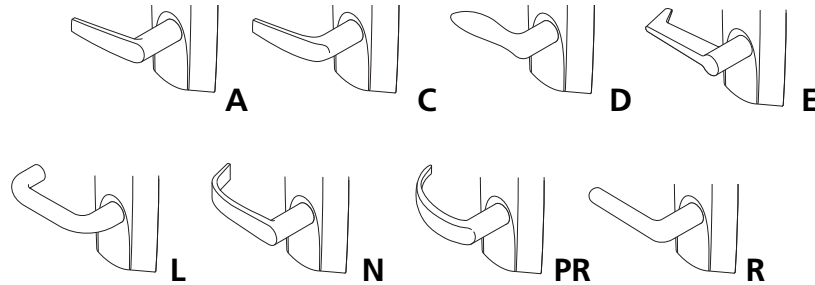

**Lever Design: FR, M, TS, Z**

**Lever:** Cast      **Keypad/Controller Escutcheon:** Zinc Die Cast  
**Trim Escutcheon:** Forged

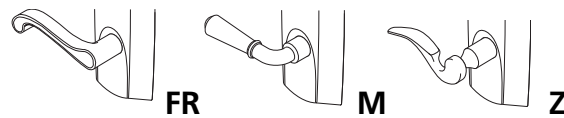

**Use with ED5200(S)(A) Rim/SecureBolt® Device**

Note: Exit Device ordered separately, starting on page 207.

Function*	Description	A, C, D, E, L, N, R, PR		FR, M, Z	
		Finish: 613E, 630	Finish: 605, 606, 611, 612, 613, 618, 619, 625, 626, 629, 722	Finish: 613E, 626	Finish: 605, 606, 611, 612, 613, 618, 619, 625, 722
9833	Without key override x M800	\$1,193.00	\$1,213.00	\$1,193.00	\$1,213.00
9834	With key override x M800				

Note: For key override add Cylinder Quick Code Option and price.  
\*When specifying function, prefix with lever design.  
Refer to ED7000 sections for mechanical push bar pricing.  
Refer to the ED5000 section push pad exit device for order info.

**Access 800® Options**

Description	Specify	Add
100 User, keypad only	M800	No Charge
2000 User, keypad only	M801	\$155.00
2000 User, proximity only	M802	\$587.00
2000 User, keypad and proximity	M803	\$652.00
2000 User, keypad and RF actuation*	M804	\$369.00
2000 User, proximity and RF actuation*	M805	\$801.00
2000 User, keypad, proximity and RF actuation*	M806	\$865.00

\* Note: RF Fob must be ordered separately. See page 104.

**ED5633(A)L & ED5634(A)L Mortise Device**

**Lever Design: A, C, D, E, L, N, PR, R**

**Lever:** Cast

**Keypad/Controller Escutcheon:** Zinc Die Cast

**Trim Escutcheon:** Forged

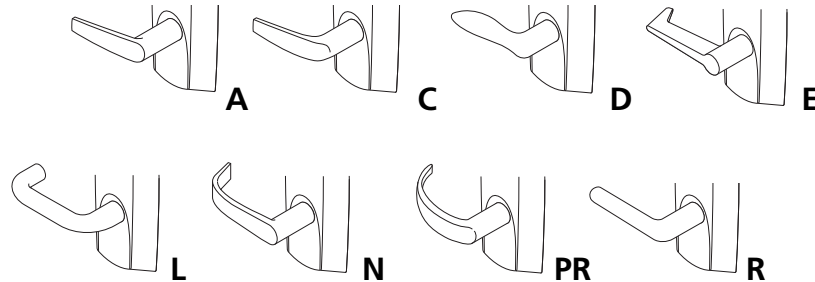

**Lever Design: FR, M, TS, Z**

**Lever:** Cast

**Keypad/Controller Escutcheon:** Zinc Die Cast

**Trim Escutcheon:** Forged

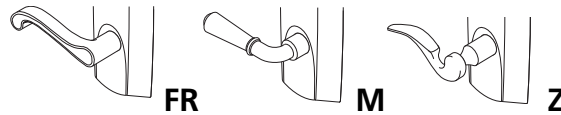

**Use with ED5633(A)L & ED5634(A)L Mortise Device**

Note: Exit Device ordered separately, starting on page 207.

Function*	Description	A, C, D, E, L, N, R, PR		FR, M, Z	
		Finish: 613E, 630	Finish: 605, 606, 611, 612, 613, 618, 619, 625, 626, 629, 722	Finish: 613E, 626	Finish: 605, 606, 611, 612, 613, 618, 619, 625, 722
9M833	Without key override x M800	\$1,152.00	\$1,172.00	\$1,152.00	\$1,172.00
9M834	With key override x M800				

Note: 9M833 and 9M834 cannot be retrofitted to an existing ED5600 Series mortise device. When ordered as "Trim Only", 9M833 and 9M834 will be furnished with the appropriate mortise lock (refer to Parts Price List for mortise lock body pricing). If a "Trim Only" order is intended for retrofitting and exit device with an M91 Bolt Monitor or an M93 Trim Monitor function, that function must be specified with the trim order to ensure the correct lock is furnished.

Note: For key override, add Cylinder Quick Code Option and price. See page 99.

\*When specifying function, prefix with lever design.

Refer to ED7000 sections for mechanical push bar pricing.

Refer to the ED5000 section push pad exit device for order info.

**Access 800® Options**

Description	Specify	Add
100 User, keypad only	M800	No Charge
2000 User, keypad only	M801	\$155.00
2000 User, proximity only	M802	\$587.00
2000 User, keypad and proximity	M803	\$652.00
2000 User, keypad and RF actuation*	M804	\$369.00
2000 User, proximity and RF actuation*	M805	\$801.00
2000 User, keypad, proximity and RF actuation*	M806	\$865.00
Gasket	M99	No Charge

Notes: 1. Available 0-bitted and Key Random (KR) only.

2. Available 0-bitted only.

\* Note: RF Fob must be ordered separately. See page 104.



**Exit Device ED5000 Series Cylinder Options\***

Description	Specify	Add or Deduct
Conventional 6-pin	6P**	Add \$83.00 per cylinder
Conventional 7-pin	7P	Add \$85.00 per cylinder
Access 3 Patented	AP	Add \$83.00 per cylinder
Access 3 Security	AS	Add \$132.00 per cylinder
Access 3 High Security, UL 437	AHS	Add \$152.00 per cylinder
Access 3 IC Patented	ACP	Add \$154.00 per cylinder
Access 3 IC Security	ACS	Add \$203.00 per cylinder
Access 3 IC High Security, UL 437	ACHS	Add \$223.00 per cylinder
Pyramid Security Fixed Core	PS	Add \$138.00 per cylinder
Pyramid Security IC	PCS	Add \$197.00 per cylinder
Pyramid High Security Fixed Core	PHS	Add \$167.00 per cylinder
Pyramid High Security IC	PCHS	Add \$235.00 per cylinder
Pyramid IC with Temporary Construction Core	CTP	Add \$154.00 per cylinder
Pyramid IC with Temporary Disposable Core	CTPD	Add \$83.00 per cylinder
Pyramid IC Less Core	CLP	Add \$83.00 per cylinder
Security	HS	Add \$189.00 per cylinder
Security IC	CHS	Add \$259.00 per cylinder
IC 6-pin	C6	Add \$154.00 per cylinder
IC 6-pin with Temporary Construction Core (Red)	CT6R	Add \$154.00 per cylinder
IC 6-pin with Temporary Construction Core (Blue)	CT6B	Add \$154.00 per cylinder
IC 6-pin with Temporary Construction Core (Green)	CT6G	Add \$154.00 per cylinder
IC 6-pin with Temporary Disposable Core	CT6D	Add \$83.00 per cylinder
IC 6-pin less core	CL6	Add \$83.00 per cylinder
SFIC 6-pin with Less Core	CLS6	Add \$83.00 per cylinder
IC 6-pin with SFIC disposable temporary core	CT6SD	Add \$83.00 per cylinder
IC 7-pin	C7	Add \$158.00 per cylinder
IC 7-pin with Temporary Construction Core (Red)	CT7R	Add \$158.00 per cylinder
IC 7-pin with Temporary Construction Core (Blue)	CT7B	Add \$158.00 per cylinder
IC 7-pin with Temporary Construction Core (Green)	CT7G	Add \$158.00 per cylinder
IC 7-pin with Temporary Disposable Core	CT7D	Add \$85.00 per cylinder
IC 7-pin less core	CL7	Add \$85.00 per cylinder
SFIC 7-pin with Less Core	CLS7	Add \$85.00 per cylinder
IC 7-pin with SFIC disposable temporary core	CT7SD	Add \$85.00 per cylinder

\*Optional dogging cylinder will be furnished with the same mechanism and keyed alike with the trim cylinder, unless otherwise specified. If different keying or cylinder type is required, specify outside (trim) first, then inside (dogging) cylinder.

\*\*6P cylinder option is supplied in 6-pin, L4 keyway, 0-bitted with two nickel silver keys.

**Keying Options\***

Description	Specify	Add or Deduct
0-Bitted with 2 blank keys	(standard)	No Charge
Keyed random	KR	No Charge
Construction master keyed <sup>1,2</sup>	CMK	Add \$16.00 per cylinder
Visual key control (VKC)		
- No stamping	VKC0	\$4.50
- Keys only	VKC1	No Charge
- Cylinders and keys <sup>3</sup>	VKC2	\$8.00
- Cylinders only <sup>3</sup>	VKC3	\$8.00
Concealed key control (CKC)		
- CKC cylinders with VKC keys	CKC2	\$8.00
- CKC cylinders only <sup>3</sup>	CKC3	\$8.00
More than 2 keys per lock	KY# (e.g., KY6)	See page 66 - Cut Keys Section

\*For key bows other than 10 and 90, specify "KB" + bow number as Quick Code, e.g. KB12.

Notes:

1. CMK Construction master keying charge is in addition to master keying charge.
2. CMK Construction master keying is not available in Pyramid or Security series.
3. VKC2, VKC3, CKC3 are not available in Pyramid or Security series.

**Strike Options\***

Description	Specify	Add or Deduct
Mortise Device		
-ANSI strike for pair of doors w/astragal (7/8" L to C)	SS078	No Charge
-Open back strike for 1-3/4" door	SB134	Add \$72.00 per lockset
-Open back strike for 2-1/4" door	SB214	\$128.00

\*(To purchase strike separately, see catalog or parts manual for part no.)

**Door Thickness Options**

Description	Specify	Add or Deduct
1-3/4"	(standard)	No Charge
2"	D200	No Charge
2-1/4"	D214	No Charge

**Door Width Options**

Description	Specify	Add or Deduct
24"	W024	Add \$292.00 per device
36"	(standard)	No Charge
48"	W048	Add \$35.00 per device

**Miscellaneous Options**

Description	Specify	Add or Deduct
Torx® Head Screws	M04	Add \$42.00 per device
ANSI wrought strike box (mortise)	M17	No Charge
Knurling outside & inside (embossed touchbar - device side) <sup>1</sup>	M20	Add \$139.00 per device
Knurling outside only (trim side) <sup>1</sup>	M21	Add \$65.00 per device
Knurling inside only (embossed touchbar - device side)	M22	Add \$74.00 per device
Abrasive coat outside and inside (trim and device) <sup>1</sup>	M23	Add \$88.00 per device
Abrasive coat inside only (device side)	M24	Add \$46.00 per device
Abrasive coat outside only (trim side) <sup>1</sup>	M25	Add \$42.00 per device
Power/Remote Unlocking Harness	M35	Add \$47.00 per lockset
Less dogging	M51	No Charge
Cylinder dogging	M52	Add \$78.00 per device
Sex nuts and bolts (SNBs)	M54	No Charge
Shim kit (for vision light)	M58	Add \$96.00 per device
Wood screws for use on fire-rated solid wood or wood core doors	M64	No Charge
Forced/Propped Door <sup>2</sup>	M861	Add \$12.50 per lockset

Notes: 1. Not available with Vineyard™ or Muséo® levers.  
 2. Not compatible with M800

**Electrified Options**

Description	Specify	Add or Deduct
Exit Alarm Device (cylinder not included)	M61	\$682.00
Bolt Position Monitoring	M91	Add \$217.00
Touchbar Monitoring or Signaling	M92*	Add \$204.00
Outside Monitoring or Signaling	M93	Add \$204.00
Motor Latch Retraction	MELR	\$835.00
Electric Dogging	M97	Add \$416.00

\*M92 is included with M861 option.

**Delayed Egress Options**

Description	Specify	Add or Deduct
Delayed Egress (15-second delay)	D	Add \$1533.00
30-second delay (may be accepted by local jurisdiction)	M88	\$103.00
BOCA 15-second delay	M89	\$103.00
BOCA 30-second delay	M90	\$103.00

**Electrified Accessories**

Description	Specify	Add or Deduct
Power Supply 9VDC Output	784	\$436.00
Power Supply 1.0 Amp @ 24 VDC Output	BPS-24-1	\$327.00
Power Supply 2 Amp @ 24 VDC Output	BPS-24-2	\$664.00
SPDT Maintained Switch (includes LED)	MKA, MKAN	\$189.00
SPDT Momentary Switch (includes LED)	MK	\$189.00
SPDT Momentary Switch (illuminated)	PB3	\$140.00
SPDT Maintained (Alt. Action) Switch	PB3EA	\$111.00
Sonalert 90lbs. @ 2ft. 12-24VDC mounted on one gang stainless steel plate	PZ1	\$93.00
Alarm Kit (cylinder is not included)**	ED50AK	\$774.00
Concealed transfer for over 120° swing doors	EPTL	\$124.00

\*\*Alarm Kit cannot be installed in the field to surface vertical rod device.  
 Any attempt to do so voids all warranties

**WM800**

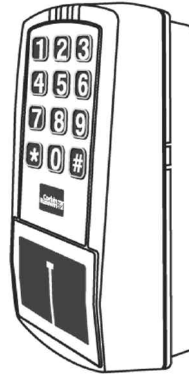

Function	Description	Finish: Dark Gray
WM800	Reader/Controller	\$1,068.00

Includes weather gasket and glass mounting kit

**Custom Wiring Diagram Services:**

Part Number	Description	Price
WD-BASIC	Basic riser / elevation diagrams	Contact 800-810-WIRE (9473) for pricing
WD-SPEC	Specification package	
WD-P2P	Point to Point package	
WD-SYSPK	System Package	
WD-SWP	Special Wiring Package	

**Keypad Versions (w/Ribbon Cable)**

Part Number	Description	Price
708F809	M800 (100 user, keypad only)	\$194.00
708F089	M801, M803, M804, M806 (2000 user keypad and keypad + prox)	\$457.00
708F099	M802, M805 (2000 user prox only)	\$372.00

**100 User Controllers – Contact 800-810-WIRE (9473) for pricing**

Part Number	Description	Price
708F819	M800 (100 user, keypad only) - Cylindrical	\$402.00
708F829	M800 (100 user, keypad only) - Mortise/Exits	

**2000 User Cylindrical Controllers**

Part Number	Description	Price
712F009	M801 (2000 user, keypad)	\$668.00
712F019	M802 or M803 (2000 user prox only or keypad + prox)	\$1,038.00
712F029	M804 (2000 user keypad + RF*)	\$890.00
712F039	M805 or M806 (prox + RF* or keypad + prox + RF*)	\$1,262.00

**2000 User Mortise & Exit Controllers**

Part Number	Description	Price
712F049	M801 (2000 user, keypad)	\$668.00
712F059	M802 or M803 (2000 user prox only or keypad + prox)	\$1,038.00
712F069	M804 (2000 user keypad + RF*)	\$890.00
712F079	M805 or M806 (prox + RF* or keypad + prox + RF*)	\$1,262.00

**Software**

Part Number	Description	Price
790F139	SoloPlus™ Software	\$326.00

\* Note: RF Fob must be ordered separately. See page 104.

**Credentials**

Part Number	Description	Order Multiples*	Order Minimums	Price (Each)
767F479	C/R 26 bit iCLASS 210 blank	Order 25-	100	\$10.50
767F489	HID 26 bit iCLASS 210 blank	Order 25-	100	
794F329	C/R 26 bit ISO Prox II blank	Order 25-	100	
794F359	HID® 26 bit ISO Prox II with logo	Order 25-	100	
794F369	HID 26 bit ISO Prox II without logo	Order 25-	100	
794F429	C/R MicroProx® tag	Order 10-	100	\$8.50
794F449	HID MicroProx tag with customer site code	Order 10-	100	
708F999	RF FOB	Order 1	1	\$97.00

\*Sold only in multiples of the number indicated.

Note: For HID credentials, site/facility code and card sequence numbers must be specified.

**Hardware**

Part Number	Description	Price
708F979	Conduit	\$13.00
793F039	784 Remote power supply (includes Plug-in Wall Transformer, 12 feet of shielded wire)	\$444.00
793F049	Plug in wall transformer	\$58.00
793F059	Cable assembly - power supply	\$55.00
793F069	Power/remote unlocking harness	\$60.00
793F089	12 V 1.2 A/Hr. Gel Cell Battery	\$64.00
793F199	Battery, Alkaline (AA) (single battery)	\$3.00
793F029	Ribbon Cable	\$34.00
712F089	New Enrollment Station	\$703.00
712F119	Forced/Propped Door Harness; when ordered separately	\$24.00
M861	Forced/Propped Door Function ordered with device	Add \$12.50 per lockset
M35	Power/Remote Unlocking Harness; ordered with device	Add \$47.00 per lockset
711F989	Power/Remote Unlocking Harness; when ordered separately	\$58.00

**Gaskets**

Part Number	Description	Price
794F509	Exit device - Keypad	\$10.00
794F519	Exit device trim	\$10.00
794F529	Cylindrical lock	\$13.00
794F539	Mortise lock	\$13.00

**Accessories**

Part Number	Description	Price
790F109	Data Transfer Device (DTD)	\$753.00

Notes: 1. Data Transfer Device (DTD) package includes: Handheld DTD, SoloPlus software CD, USB cable, four (4) AA batteries, instructions and a lanyard.



Look for the  *MicroShield* icon.

**MicroShield®**

As part of their promise to provide innovative solutions to their customers, certain ASSA ABLOY Group brands offer the MicroShield® technology, a silver-based antimicrobial coating designed to inhibit the growth of bacteria.

MicroShield® is a registered trademark of Yale Security Inc., an ASSA ABLOY Group company.

Product	Series	MicroShield® Coated Components
Mortise Locks	ML2000 Series	Knobs/Levers, roses and/or escutcheons

**AVAILABLE FINISHES**

- MicroShield® is available on 626 and 630. Other finishes available by Special Product Application Request Form only.
- Specify 626C (satin chrome plated) or 630C (satin stainless steel) when ordering.
- MicroShield® coating will be applied over 626 and 630 finishes. All components will match 626.

*Note: MicroShield® coating will only be applied to "high touch" components.*

**HOW TO ORDER**

Product	How to Order
Mortise Locks	ML2055 x LWA x 626C x RHR

Description	Add
Mortise Locks	Add \$62.00

**Standard Features**

**Handing**

Field reversible

**Door Thickness**

1-3/4"

**Backset**

2-3/4"

**Warranty**

10 Years

**Strike**

ANSI straight lip  
4-7/8" x 1-1/4" x 1-1/8" lip to center

**Cylinder**

Brass, 6-pin, L4 keyway, 0-bitted

**Keys**

Two nickel silver keys

**Case Quantity**

6

**Case Weight**

Variable

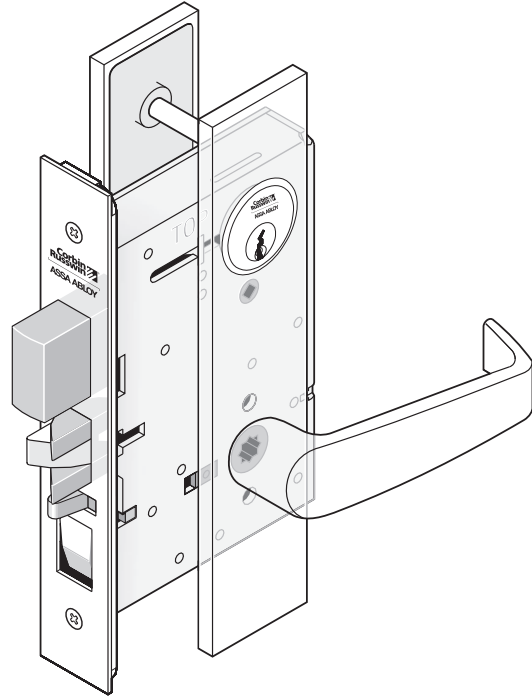

**Ordering Example**

**Stock Order**

Quantity	Series/Function	Trim	Finish	Hand
100	ML2055	LSB	626	RHR

**Split Trim/Split Finish**

Quantity	Series/Function	Trim		Finish		Hand
		Outside	Inside	Outside	Inside	
12	ML2055	LSB	GRC	626	625	RHR

Split trim is not available mixing escutcheon with sectional trim or with a different escutcheon

**Contract/Detailed Order**

Quantity	Keyset	Series/Function	Trim	Finish	Hand	Strike	Misc. Options	Cylinder and Keying
24	AA1	ML2055	LSB	626	RHR	SA200	M17-M26	C7-VKC3

**Working Trim Only**

Quantity	Function only	Trim	Finish	Hand	Door Thickness	Misc. Options
6	ML2055	LWA	626	RHR	D214	M31

(includes grip and spindle, rose or escutcheon, thumbturn, adapters and screws)

**High Security Monitoring Option Order**

Quantity	Series/Function	Technology Code	Trim	Finish	Hand	Fail Safe/ Fail Secure	High Security Monitoring Options
24	ML20608	NAC	ASA	626	RHR	SEC	PHRR01





**LWA RWA**  
Lever: Wrought  
Rose: Wrought

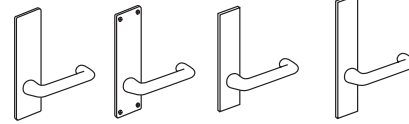

**LWM LWN LWP LWR**  
Lever: Wrought  
Escutcheon: Wrought  
Lever: Wrought  
Escutcheon: Solid Stainless Steel or Forged Brass

<b>Levers: LW, RW</b>	
<b>Roses: A</b>	
Roses: B, F (see note 1)	
<b>613E, 630</b>	<b>605, 606, 611, 612, 613, 618, 619, 625, 626, 629, 722</b>

<b>Levers: LW, RW</b>	
<b>Escutcheons: M, N, P</b>	
<b>613E, 626</b>	<b>605, 606, 611, 612, 613, 618, 619, 625, 629, 630, 722</b>

<b>Levers: LW, RW</b>	
<b>Escutcheons: R (see note 2)</b>	
<b>613E, 626</b>	<b>605, 606, 611, 612, 613, 618, 619, 625, 629, 630, 722</b>

Function	Model	Description	Price 1	Price 2	Price 3	Price 4	Price 5	Price 6
Non-Keyed	ML2010	Passage	\$603.00	\$627.00	\$623.00	\$647.00	\$677.00	\$701.00
	ML2020	Privacy	\$722.00	\$746.00	\$742.00	\$766.00	\$796.00	\$820.00
	ML2030	Privacy						
	ML2060	Privacy	\$659.00	\$683.00	\$679.00	\$703.00	\$733.00	\$757.00
	ML2050	Half Dummy	\$313.00	\$325.00	\$323.00	\$347.00	\$350.00	\$374.00
	ML2070	Full Dummy	\$626.00	\$650.00	\$646.00	\$670.00	\$700.00	\$724.00
	ML2080	Half Active Dummy Trim	\$303.00	\$315.00	\$323.00	\$347.00	\$377.00	\$401.00
	ML2090	Full Active Dummy Trim	\$616.00	\$640.00	\$636.00	\$660.00	\$690.00	\$714.00
Single Cylinder	ML2003	Classroom	\$733.00	\$757.00	\$753.00	\$777.00	\$807.00	\$831.00
	ML2051	Office						
	ML2055	Classroom						
	ML2056	Classroom						
	ML2057	Storeroom						
	ML2069	Institution Privacy						
ML2053	Entrance	\$746.00	\$770.00	\$766.00	\$790.00	\$820.00	\$844.00	
ML2054	Entrance							
ML2058	Entrance Holdback							
ML2068	Privacy or Apartment							
Single Cylinder with Deadbolt	ML2024	Entrance	\$769.00	\$793.00	\$789.00	\$813.00	\$843.00	\$867.00
	ML2048	Entrance						
	ML2065	Dormitory						
	ML2059	Security Storeroom						
	ML2067	Apartment						
	ML2073	Classroom Security						
	ML2075	Entrance/Office						
ML2029	Hotel	\$824.00	\$848.00	\$844.00	\$868.00	\$898.00	\$922.00	
Double Cylinder	ML2002	Classroom Intruder	\$816.00	\$840.00	\$836.00	\$860.00	\$890.00	\$914.00
	ML2032	Institution						
	ML2042	Entrance						
	ML2052	Classroom Intruder						
Double Cylinder with Deadbolt	ML2022	Store Door	\$852.00	\$876.00	\$872.00	\$896.00	\$926.00	\$950.00
	ML2062	Intruder Deadbolt						
	ML2072	Classroom Security						
	ML2082	Intruder						
	ML2092	Dormitory Security Institution						
Full Working Trim (Quick Code M31) No cylinder; includes thumbturn lever			\$506.00	\$530.00	\$526.00	\$550.00	\$580.00	\$604.00

NOTE:  
 1 - Rose substitutions for LWA, RWA: 2-1/4" cast rose in place of 2-1/4" wrought rose, substitute letter "B" in place of "A" (e.g. LWB). **Add \$38.00 per lockset.** 2-7/8" cast rose in place of 2-1/4" wrought rose, substitute letter "F" in place of "A" (e.g. RWF). **Add \$52.00 per lockset.**  
 2 - "R" Escutcheon trims are available for 1 3/8", 1 3/4", 2", or 2 1/4" door thickness only.

**LSA**

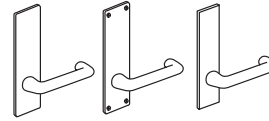
 Lever: Cast  
Rose: Wrought

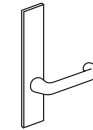
**LSM LSN LSP**

 Lever: Cast  
Escutcheon: Wrought

**LSR**

 Lever: Cast  
Escutcheon: Solid Stainless Steel  
or Forged Brass

<b>Levers: LS</b>	
<b>Roses: A</b>	
Roses: B, F (see note 1)	
<b>613E, 626</b>	<b>605, 606, 611, 612, 613, 618, 619, 625, 629, 630, 722</b>

<b>Levers: LS</b>	
<b>Escutcheons: M, N, P</b>	
<b>613E, 626</b>	<b>605, 606, 611, 612, 613, 618, 619, 625, 629, 630, 722</b>

<b>Levers: LS</b>	
<b>Escutcheons: R (see note 2)</b>	
<b>613E, 626</b>	<b>605, 606, 611, 612, 613, 618, 619, 625, 629, 630, 722</b>

**Function**

Non-Keyed	ML2010	Passage	\$623.00	\$709.00	\$760.00	\$784.00	\$794.00	\$818.00
	ML2020	Privacy	\$732.00	\$824.00	\$869.00	\$893.00	\$903.00	\$927.00
	ML2030	Privacy						
	ML2060	Privacy	\$698.00	\$788.00	\$835.00	\$859.00	\$869.00	\$893.00
	ML2050	Half Dummy	\$239.00	\$334.00	\$401.00	\$425.00	\$418.00	\$442.00
	ML2070	Full Dummy	\$478.00	\$573.00	\$802.00	\$826.00	\$836.00	\$860.00
	ML2080	Half Active Dummy Trim	\$423.00	\$511.00	\$398.00	\$422.00	\$442.00	\$466.00
	ML2090	Full Active Dummy Trim	\$662.00	\$750.00	\$799.00	\$823.00	\$833.00	\$857.00
Single Cylinder	ML2003	Classroom	\$779.00	\$874.00	\$916.00	\$940.00	\$950.00	\$974.00
	ML2051	Office						
	ML2055	Classroom						
	ML2056	Classroom						
	ML2057	Storeroom						
	ML2069	Institution Privacy						
ML2053	Entrance	\$792.00	\$887.00	\$929.00	\$953.00	\$963.00	\$987.00	
ML2054	Entrance							
ML2058	Entrance Holdback							
ML2068	Privacy or Apartment							
Single Cylinder with Deadbolt	ML2024	Entrance	\$815.00	\$912.00	\$952.00	\$976.00	\$986.00	\$1,010.00
	ML2048	Entrance						
	ML2065	Dormitory						
	ML2059	Security Storeroom						
	ML2067	Apartment						
	ML2073	Classroom Security						
	ML2075	Entrance/Office						
ML2029	Hotel	\$870.00	\$970.00	\$1,007.00	\$1,031.00	\$1,041.00	\$1,065.00	
Double Cylinder	ML2002	Classroom Intruder	\$862.00	\$961.00	\$999.00	\$1,023.00	\$1,033.00	\$1,057.00
	ML2032	Institution						
	ML2042	Entrance						
	ML2052	Classroom Intruder						
Double Cylinder with Deadbolt	ML2022	Store Door	\$898.00	\$999.00	\$1,035.00	\$1,059.00	\$1,069.00	\$1,093.00
	ML2062	Intruder Deadbolt						
	ML2072	Classroom Security Intruder						
	ML2082	Dormitory						
	ML2092	Security Institution						
Full Working Trim (Quick Code M31) No cylinder; includes thumbturn lever			\$512.00	\$607.00	\$705.00	\$729.00	\$739.00	\$763.00

**NOTE:**

 1 - Rose substitutions for LSA: 2-1/4" cast rose in place of 2-1/4" wrought rose, substitute letter "B" in place of "A" (e.g. LSB). **Add \$38.00 per lockset.**  
 2-7/8" cast rose in place of 2-1/4" wrought rose, substitute letter "F" in place of "A" (e.g. LSF). **Add \$52.00 per lockset.**

2 - "R" Escutcheon trims are available for 1 3/8", 1 3/4", or 2 1/4" door thickness only

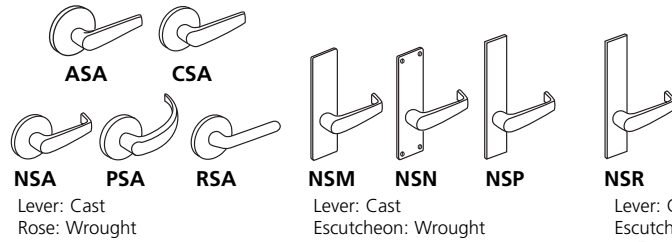

<b>Levers: AS, CS, NS PS, RS</b> <b>Roses: A</b> <b>Roses: B, F (see note 1)</b>		<b>Levers: AS, CS, NS, PS, RS</b> <b>Escutcheons: M, N, P</b>		<b>Levers: AS, CS, NS, PS, RS</b> <b>Escutcheons: R (see note 2)</b>	
<b>613E, 626</b>	<b>605, 606, 611, 612, 613, 618, 619, 625, 629, 630, 722</b>	<b>613E, 626</b>	<b>605, 606, 611, 612, 613, 618, 619, 625, 629, 630, 722</b>	<b>613E, 626</b>	<b>605, 606, 611, 612, 613, 618, 619, 625, 629, 630, 722</b>

Function	Model	Description	Price 1	Price 2	Price 3	Price 4	Price 5	Price 6
Non-Keyed	ML2010	Passage	\$740.00	\$764.00	\$760.00	\$784.00	\$794.00	\$818.00
	ML2020	Privacy	\$849.00	\$873.00	\$869.00	\$893.00	\$903.00	\$927.00
	ML2030	Privacy						
	ML2060	Privacy	\$815.00	\$839.00	\$835.00	\$859.00	\$869.00	\$893.00
	ML2050	Half Dummy	\$391.00	\$403.00	\$401.00	\$425.00	\$418.00	\$442.00
	ML2070	Full Dummy	\$782.00	\$806.00	\$802.00	\$826.00	\$836.00	\$860.00
	ML2080	Half Active Dummy Trim	\$388.00	\$400.00	\$398.00	\$422.00	\$442.00	\$466.00
	ML2090	Full Active Dummy Trim	\$779.00	\$803.00	\$799.00	\$823.00	\$833.00	\$857.00
Single Cylinder	ML2003	Classroom	\$896.00	\$920.00	\$916.00	\$940.00	\$950.00	\$974.00
	ML2051	Office						
	ML2055	Classroom						
	ML2056	Classroom						
	ML2057	Storeroom	\$909.00	\$933.00	\$929.00	\$953.00	\$963.00	\$987.00
	ML2069	Institution Privacy						
	ML2053	Entrance						
	ML2054	Entrance						
ML2058	Entrance Holdback	\$987.00	\$1,011.00	\$1,007.00	\$1,031.00	\$1,041.00	\$1,065.00	
ML2068	Privacy or Apartment							
Single Cylinder with Deadbolt	ML2024	Entrance	\$932.00	\$956.00	\$952.00	\$976.00	\$986.00	\$1,010.00
	ML2048	Entrance						
	ML2065	Dormitory						
	ML2059	Security Storeroom						
	ML2067	Apartment	\$987.00	\$1,011.00	\$1,007.00	\$1,031.00	\$1,041.00	\$1,065.00
	ML2073	Classroom Security						
	ML2075	Entrance/Office						
ML2029	Hotel							
Double Cylinder	ML2002	Classroom Intruder	\$979.00	\$1,003.00	\$999.00	\$1,023.00	\$1,033.00	\$1,057.00
	ML2032	Institution						
	ML2042	Entrance						
	ML2052	Classroom Intruder						
Double Cylinder with Deadbolt	ML2022	Store Door	\$1,015.00	\$1,039.00	\$1,035.00	\$1,059.00	\$1,069.00	\$1,093.00
	ML2062	Intruder Deadbolt						
	ML2072	Classroom Security						
	ML2082	Intruder						
	ML2092	Dormitory Security Institution						
Full Working Trim (Quick Code M31) No cylinder; includes thumbturn lever			\$685.00	\$709.00	\$705.00	\$729.00	\$739.00	\$763.00

**NOTE:**

1 - Rose substitutions for ASA, CSA, etc.: 2-1/4" cast rose in place of 2-1/4" wrought rose, substitute letter "B" in place of "A" (e.g. NSB). **Add \$38.00 per lockset.** 2-7/8" cast rose in place of 2-1/4" wrought rose, substitute letter "F" in place of "A" (e.g. NSF). **Add \$52.00 per lockset.**

2 - "R" Escutcheon trims are available for 1 3/8", 1 3/4", or 2 1/4" door thickness only



**DSA ESA**  
Lever: Cast  
Rose: Wrought

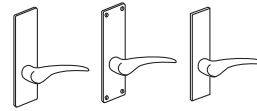

**DSM DSN DSP**  
Lever: Cast  
Escutcheon: Wrought

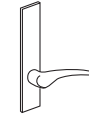

**DSR**  
Lever: Cast  
Escutcheon: Solid Stainless Steel  
or Forged Brass

<b>Levers: DS, ES</b>	
<b>Roses: A</b>	
<b>Roses: B, F (see note 1)</b>	
<b>613E, 626</b>	<b>605, 606, 611, 612, 613, 618, 619, 625, 629, 630, 722</b>

<b>Levers: DS, ES</b>	
<b>Escutcheons: M, N, P</b>	
<b>613E, 626</b>	<b>605, 606, 611, 612, 613, 618, 619, 625, 629, 630, 722</b>

<b>Levers: DS, ES</b>	
<b>Escutcheons: R (see note 2)</b>	
<b>613E, 626</b>	<b>605, 606, 611, 612, 613, 618, 619, 625, 629, 630, 722</b>

Function														
Non-Keyed	ML2010	Passage	\$765.00	\$789.00	\$785.00	\$809.00	\$819.00	\$843.00						
	ML2020	Privacy	\$874.00	\$898.00	\$884.00	\$908.00	\$928.00	\$952.00						
	ML2030	Privacy												
	ML2060	Privacy												
	ML2050	Half Dummy												
	ML2070	Full Dummy												
	ML2080	Half Active Dummy Trim												
	ML2090	Full Active Dummy Trim												
Single Cylinder	ML2003	Classroom							\$921.00	\$945.00	\$941.00	\$965.00	\$975.00	\$999.00
	ML2051	Office												
	ML2055	Classroom												
	ML2056	Classroom												
	ML2057	Storeroom												
	ML2069	Institution Privacy												
	ML2053	Entrance	\$934.00	\$958.00	\$954.00	\$978.00	\$988.00	\$1,012.00						
	ML2054	Entrance												
	ML2058	Entrance Holdback												
ML2068	Privacy or Apartment													
Single Cylinder with Deadbolt	ML2024	Entrance	\$957.00	\$981.00	\$977.00	\$1,001.00	\$1,011.00	\$1,035.00						
	ML2048	Entrance												
	ML2065	Dormitory												
	ML2059	Security Storeroom												
	ML2067	Apartment												
	ML2073	Classroom Security												
	ML2075	Entrance/Office												
ML2029	Hotel	\$1,012.00	\$1,036.00	\$1,032.00	\$1,056.00	\$1,066.00	\$1,090.00							
Double Cylinder	ML2002	Classroom Intruder	\$1,004.00	\$1,028.00	\$1,024.00	\$1,048.00	\$1,058.00	\$1,082.00						
	ML2032	Institution												
	ML2042	Entrance												
	ML2052	Classroom Intruder												
Double Cylinder with Deadbolt	ML2022	Store Door	\$1,040.00	\$1,064.00	\$1,060.00	\$1,084.00	\$1,094.00	\$1,118.00						
	ML2062	Intruder Deadbolt												
	ML2072	Classroom Security Intruder												
	ML2082	Dormitory												
	ML2092	Security Institution												
Full Working Trim (Quick Code M31) No cylinder; includes thumbturn lever			\$735.00	\$759.00	\$755.00	\$779.00	\$789.00	\$813.00						

NOTE:  
 1 - Rose substitutions for DSA, ESA: 2-1/4" cast rose in place of 2-1/4" wrought rose, substitute letter "B" in place of "A" (e.g.DSB). **Add \$38.00 per lockset.**  
 2-7/8" cast rose in place of 2-1/4" wrought rose, substitute letter "F" in place of "A" (e.g. ESF). **Add \$52.00 per lockset.**  
 2 -"R" Escutcheon trims are available for 1 3/8", 1 3/4", or 2 1/4" door thickness only



**GRC**

**GRD**

**GRE**



**BRC**

**BRD**

**BRE**

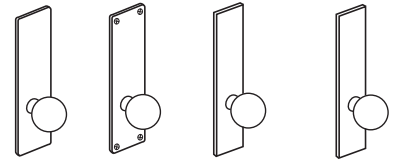

**GRM**

**GRN**

**GRP**

**GRR**

Knob: Wrought Reinforced  
Rose: Wrought

Knob: Wrought Reinforced  
Escutcheon: Wrought

Knob: Wrought Reinforced  
Escutcheon: Solid Stainless  
Steel or Forged Brass

Knobs: GR, BR Roses: C, D, E	
613E, 626	605, 606, 611, 612, 613, 618, 619, 625, 722

Knobs: GR, BR Escutcheons: M, N, P	
613E, 626	605, 606, 611, 612, 613, 618, 619, 625, 722

Knobs: GR, BR Escutcheons: R (see note 1)	
613E, 626	605, 606, 611, 612, 613, 618, 619, 625, 722

Function	Model	Description	613E, 626	605, 606, 611, 612, 613, 618, 619, 625, 722	613E, 626	605, 606, 611, 612, 613, 618, 619, 625, 722	613E, 626	605, 606, 611, 612, 613, 618, 619, 625, 722
Non-Keyed	ML2010	Passage	\$808.00	\$832.00	\$828.00	\$852.00	\$862.00	\$886.00
	ML2020	Privacy	\$881.00	\$905.00	\$901.00	\$925.00	\$935.00	\$959.00
	ML2030	Privacy						
	ML2060	Privacy	\$864.00	\$888.00	\$884.00	\$908.00	\$918.00	\$942.00
	ML2050	Half Dummy	\$423.00	\$447.00	\$433.00	\$445.00	\$450.00	\$462.00
	ML2070	Full Dummy	\$846.00	\$870.00	\$866.00	\$890.00	\$900.00	\$924.00
	ML2080	Half Active Dummy Trim	\$388.00	\$412.00	\$398.00	\$422.00	\$415.00	\$427.00
	ML2090	Full Active Dummy Trim	\$811.00	\$835.00	\$831.00	\$855.00	\$865.00	\$889.00
Single Cylinder	ML2003	Classroom	\$928.00	\$952.00	\$948.00	\$972.00	\$982.00	\$1,006.00
	ML2051	Office						
	ML2055	Classroom						
	ML2056	Classroom						
	ML2057	Storeroom						
	ML2069	Institution Privacy						
	ML2053	Entrance	\$941.00	\$965.00	\$961.00	\$985.00	\$995.00	\$1,019.00
	ML2054	Entrance						
	ML2058	Entrance Holdback						
ML2068	Privacy or Apartment							
Single Cylinder with Deadbolt	ML2024	Entrance	\$964.00	\$988.00	\$984.00	\$1,008.00	\$1,018.00	\$1,042.00
	ML2048	Entrance						
	ML2065	Dormitory						
	ML2059	Security Storeroom						
	ML2067	Apartment						
	ML2073	Classroom Security						
	ML2075	Entrance/Office						
	ML2029	Hotel	\$1,019.00	\$1,043.00	\$1,039.00	\$1,063.00	\$1,073.00	\$1,097.00
Double Cylinder	ML2002	Classroom Intruder	\$1,011.00	\$1,035.00	\$1,031.00	\$1,055.00	\$1,065.00	\$1,089.00
	ML2032	Institution						
	ML2042	Entrance						
	ML2052	Classroom Intruder						
Double Cylinder with Deadbolt	ML2022	Store Door	\$1,047.00	\$1,071.00	\$1,067.00	\$1,091.00	\$1,101.00	\$1,125.00
	ML2062	Intruder Deadbolt						
	ML2072	Classroom Security Intruder						
	ML2082	Dormitory						
	ML2092	Security Institution						
Full Working Trim (Quick Code M31) No cylinder; includes thumb-turn lever			\$749.00	\$773.00	\$769.00	\$793.00	\$803.00	\$827.00

NOTE 1:

"R" Escutcheon trims are available for 1 3/8", 1 3/4", or 2 1/4" door thickness only

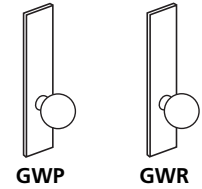
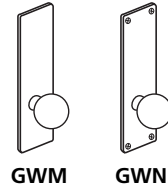

Knob: Wrought  
Rose: Wrought

Knob: Wrought  
Escutcheon: Wrought

Knob: Wrought  
Escutcheon: Solid Stainless  
Steel or Forged Brass

Knobs: GW, BW Roses: C, D, E		Knobs: GW, BW Escutcheons: M, N, P		Knobs: GW, BW Escutcheons: R (see note 1)	
613E, 626	605, 606, 611, 612, 613, 618, 619, 625, 722	613E, 626	605, 606, 611, 612, 613, 618, 619, 625, 722	613E, 626	605, 606, 611, 612, 613, 618, 619, 625, 722

Function	Model	Description	Price 1	Price 2	Price 3	Price 4	Price 5	Price 6
Non-Keyed	ML2010	Passage	\$750.00	\$774.00	\$770.00	\$794.00	\$813.00	\$837.00
	ML2020	Privacy	\$823.00	\$847.00	\$843.00	\$867.00	\$877.00	\$901.00
	ML2030	Privacy						
	ML2060	Privacy	\$806.00	\$830.00	\$826.00	\$850.00	\$839.00	\$863.00
	ML2050	Half Dummy	\$365.00	\$377.00	\$375.00	\$387.00	\$392.00	\$404.00
	ML2070	Full Dummy	\$730.00	\$754.00	\$750.00	\$774.00	\$784.00	\$808.00
	ML2080	Half Active Dummy Trim	\$388.00	\$400.00	\$398.00	\$410.00	\$415.00	\$427.00
	ML2090	Full Active Dummy Trim	\$753.00	\$777.00	\$773.00	\$797.00	\$807.00	\$831.00
Single Cylinder	ML2003	Classroom	\$870.00	\$894.00	\$890.00	\$914.00	\$924.00	\$948.00
	ML2051	Office						
	ML2055	Classroom						
	ML2056	Classroom						
	ML2057	Storeroom	\$883.00	\$907.00	\$903.00	\$927.00	\$937.00	\$961.00
	ML2069	Institution Privacy						
	ML2053	Entrance						
	ML2054	Entrance						
	ML2058	Entrance Holdback						
ML2068	Privacy or Apartment							
Single Cylinder with Deadbolt	ML2024	Entrance	\$906.00	\$930.00	\$926.00	\$950.00	\$960.00	\$984.00
	ML2048	Entrance						
	ML2065	Dormitory						
	ML2059	Security Storeroom						
	ML2067	Apartment						
	ML2073	Classroom Security						
	ML2075	Entrance/Office						
	ML2029	Hotel	\$961.00	\$985.00	\$981.00	\$1,005.00	\$1,020.00	\$1,044.00
Double Cylinder	ML2002	Classroom Intruder	\$953.00	\$977.00	\$973.00	\$997.00	\$1,007.00	\$1,031.00
	ML2032	Institution						
	ML2042	Entrance						
	ML2052	Classroom Intruder						
Double Cylinder with Deadbolt	ML2022	Store Door	\$989.00	\$1,013.00	\$1,009.00	\$1,033.00	\$1,043.00	\$1,067.00
	ML2062	Intruder Deadbolt						
	ML2072	Classroom Security Intruder						
	ML2082	Dormitory						
	ML2092	Security Institution						
Full Working Trim (Quick Code M31) No cylinder; includes thumb-turn lever			\$633.00	\$657.00	\$653.00	\$677.00	\$687.00	\$711.00

Note: 1  
"R" Escutcheon trims are available for 1 3/8", 1 3/4", or 2 1/4" door thickness only.



**YWA**

Knob: Wrought  
Rose: Wrought



**YWM**

Knob: Wrought  
Escutcheon: Wrought



**YWN**



**YWP**

Knob: Wrought  
Escutcheon: Solid Stainless  
Steel or Forged Brass



**YWR**

<b>Knobs: YW</b>	
<b>Roses: A</b>	
Roses: B, F (see note 1)	
<b>613E, 626</b>	<b>605, 606, 611, 612, 613, 618, 619, 625, 722</b>

<b>Knobs: YW</b>	
<b>Escutcheons: M, N, P</b>	
<b>613E, 626</b>	<b>605, 606, 611, 612, 613, 618, 619, 625, 722</b>

<b>Knobs: YW</b>	
<b>Escutcheons: R</b>	
(see note 2)	
<b>613E, 626</b>	<b>605, 606, 611, 612, 613, 618, 619, 625, 722</b>

Function	YWA		YWM		YWN		YWP		YWR	
	613E, 626	605, 606, 611, 612, 613, 618, 619, 625, 722	613E, 626	605, 606, 611, 612, 613, 618, 619, 625, 722	613E, 626	605, 606, 611, 612, 613, 618, 619, 625, 722	613E, 626	605, 606, 611, 612, 613, 618, 619, 625, 722	613E, 626	605, 606, 611, 612, 613, 618, 619, 625, 722
Non-Keyed	ML2010	Passage	\$808.00	\$832.00	\$828.00	\$852.00	\$862.00	\$886.00		
	ML2020	Privacy								
	ML2030	Privacy	\$881.00	\$905.00	\$901.00	\$925.00	\$935.00	\$959.00		
	ML2060	Privacy	\$864.00	\$888.00	\$884.00	\$908.00	\$918.00	\$942.00		
	ML2050	Half Dummy	\$423.00	\$447.00	\$433.00	\$445.00	\$450.00	\$462.00		
	ML2070	Full Dummy	\$846.00	\$870.00	\$866.00	\$890.00	\$900.00	\$924.00		
	ML2080	Half Active Dummy Trim	\$388.00	\$412.00	\$398.00	\$422.00	\$415.00	\$427.00		
	ML2090	Full Active Dummy Trim	\$811.00	\$835.00	\$831.00	\$855.00	\$865.00	\$889.00		
Single Cylinder	ML2003	Classroom								
	ML2051	Office								
	ML2055	Classroom	\$928.00	\$952.00	\$948.00	\$972.00	\$982.00	\$1,006.00		
	ML2056	Classroom								
	ML2057	Storeroom								
	ML2069	Institution Privacy								
	ML2053	Entrance								
	ML2054	Entrance	\$941.00	\$965.00	\$961.00	\$985.00	\$995.00	\$1,019.00		
ML2058	Entrance Holdback									
ML2068	Privacy or Apartment									
Single Cylinder with Deadbolt	ML2024	Entrance								
	ML2048	Entrance								
	ML2065	Dormitory								
	ML2059	Security Storeroom	\$964.00	\$988.00	\$984.00	\$1,008.00	\$1,018.00	\$1,042.00		
	ML2067	Apartment								
	ML2073	Classroom Security								
	ML2075	Entrance/Office								
ML2029	Hotel	\$1,019.00	\$1,043.00	\$1,039.00	\$1,063.00	\$1,073.00	\$1,097.00			
Double Cylinder	ML2002	Classroom Intruder								
	ML2032	Institution	\$1,011.00	\$1,035.00	\$1,031.00	\$1,055.00	\$1,065.00	\$1,089.00		
	ML2042	Entrance								
	ML2052	Classroom Intruder								
ML2022	Store Door									
Double Cylinder with Deadbolt	ML2062	Intruder Deadbolt								
	ML2072	Classroom Security Intruder	\$1,047.00	\$1,071.00	\$1,067.00	\$1,091.00	\$1,101.00	\$1,125.00		
	ML2082	Dormitory								
	ML2092	Security Institution								
Full Working Trim (Quick Code M31) No cylinder; includes thumb-turn lever		\$749.00							\$773.00	\$769.00

NOTES:

1 - Rose substitutions for YWA: 2-1/4" cast rose in place of 2-1/4" wrought rose, substitute letter "B" in place of "A" (e.g. YWB). **Add \$38.00 per lockset.**  
2-7/8" cast rose in place of 2-1/4" wrought rose, substitute letter "F" in place of "A" (e.g. YWF). **Add \$52.00 per lockset.**

2 - "R" Escutcheon trims are available for 1 3/8", 1 3/4", or 2 1/4" door thickness only



**GSA**

Knob: Cast  
Rose: Wrought



**GSM**

Knob: Cast  
Escutcheon: Wrought



**GSN**



**GSP**

Knob: Cast  
Escutcheon: Solid Stainless Steel or Forged Brass



**GSR**

<b>Knobs: GS</b>	
<b>Roses: A</b>	
Roses: B, F (see note 1)	
<b>613E, 626</b>	<b>605, 606, 611, 612, 613, 618, 619, 625, 722</b>

<b>Knobs: GS</b>	
<b>Escutcheons: M, N, P</b>	
<b>613E, 626</b>	<b>605, 606, 611, 612, 613, 618, 619, 625, 722</b>

<b>Knobs: GS</b>	
<b>Escutcheons: R</b>	
(see note 2)	
<b>613E, 626</b>	<b>605, 606, 611, 612, 613, 618, 619, 625, 722</b>

**Function**

Function	Model	Description	613E, 626	605, 606, 611, 612, 613, 618, 619, 625, 722	613E, 626	605, 606, 611, 612, 613, 618, 619, 625, 722	613E, 626	605, 606, 611, 612, 613, 618, 619, 625, 722
Non-Keyed	ML2010	Passage	\$927.00	\$951.00	\$947.00	\$971.00	\$981.00	\$1,005.00
	ML2020	Privacy	\$1,000.00	\$1,024.00	\$1,020.00	\$1,044.00	\$1,054.00	\$1,078.00
	ML2030	Privacy						
	ML2060	Privacy	\$983.00	\$1,007.00	\$1,003.00	\$1,027.00	\$1,037.00	\$1,061.00
	ML2050	Half Dummy	\$374.00	\$386.00	\$384.00	\$396.00	\$401.00	\$413.00
	ML2070	Full Dummy	\$748.00	\$772.00	\$768.00	\$792.00	\$802.00	\$826.00
	ML2080	Half Active Dummy Trim	\$556.00	\$568.00	\$566.00	\$590.00	\$583.00	\$595.00
	ML2090	Full Active Dummy Trim	\$930.00	\$954.00	\$950.00	\$974.00	\$984.00	\$1,008.00
Single Cylinder	ML2003	Classroom	\$1,047.00	\$1,071.00	\$1,067.00	\$1,091.00	\$1,101.00	\$1,125.00
	ML2051	Office						
	ML2055	Classroom						
	ML2056	Classroom						
	ML2057	Storeroom						
	ML2069	Institution Privacy						
	ML2053	Entrance	\$1,060.00	\$1,084.00	\$1,080.00	\$1,104.00	\$1,114.00	\$1,138.00
	ML2054	Entrance						
ML2058	Entrance Holdback							
ML2068	Privacy or Apartment							
Single Cylinder with Deadbolt	ML2024	Entrance	\$1,083.00	\$1,107.00	\$1,103.00	\$1,127.00	\$1,137.00	\$1,161.00
	ML2048	Entrance						
	ML2065	Dormitory						
	ML2059	Security Storeroom						
	ML2067	Apartment						
	ML2073	Classroom Security						
	ML2075	Entrance/Office						
ML2029	Hotel	\$1,138.00	\$1,162.00	\$1,158.00	\$1,182.00	\$1,192.00	\$1,216.00	
Double Cylinder	ML2002	Classroom Intruder	\$1,130.00	\$1,154.00	\$1,150.00	\$1,174.00	\$1,184.00	\$1,208.00
	ML2032	Institution						
	ML2042	Entrance						
	ML2052	Classroom Intruder						
Double Cylinder with Deadbolt	ML2022	Store Door	\$1,166.00	\$1,190.00	\$1,186.00	\$1,210.00	\$1,220.00	\$1,244.00
	ML2062	Intruder Deadbolt						
	ML2072	Classroom Security Intruder						
	ML2082	Dormitory						
	ML2092	Security Institution						
Full Working Trim (Quick Code M31) No cylinder; includes thumb-turn lever			\$646.00	\$670.00	\$666.00	\$690.00	\$700.00	\$724.00

**NOTES:**

- 1 - Rose substitutions for GSA: 2-1/4" cast rose in place of 2-1/4" wrought rose, substitute letter "B" in place of "A" (e.g.GSB). **Add \$38.00 per lockset.**
- 2-7/8" cast rose in place of 2-1/4" wrought rose, substitute letter "F" in place of "A" (e.g. GSF). **Add \$52.00 per lockset.**
- 2 - "R" Escutcheon trims are available for 1 3/8", 1 3/4", or 2 1/4" door thickness only



**Lever Designs: FSG, MSG, ZSG**



**Lever: Rose:**

Cast Cast



FSG



MSG



ZSG

**Frascati**



**Lever Designs: FSL, MSL<sup>1</sup>, ZSL**



**Lever: Escutcheon:**

Cast Cast



FSL

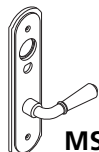

MSL



ZSL

**Merlot**

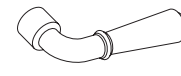

**Zinfandel**



Function	Description		FSG, MSG, ZSG		FSL, MSL, ZSL	
			613E, 626	605, 606, 611, 612, 613 <sup>2</sup> , 613L <sup>2</sup> , 618, 619, 625, 722	613E, 626	605, 606, 611, 612, 613 <sup>2</sup> , 613L <sup>2</sup> , 618, 619, 625, 722
Non-Keyed	ML2010	Passage	\$765.00	\$789.00	\$819.00	\$843.00
	ML2020	Privacy	\$874.00	\$898.00	\$928.00	\$952.00
	ML2030	Privacy				
	ML2060	Privacy	\$840.00	\$864.00	\$894.00	\$918.00
	ML2050	Half Dummy	\$416.00	\$440.00	\$443.00	\$467.00
	ML2070	Full Dummy	\$832.00	\$856.00	\$886.00	\$910.00
	ML2080	Half Active Dummy Trim	\$388.00	\$412.00	\$415.00	\$439.00
	ML2090	Full Active Dummy Trim	\$804.00	\$828.00	\$858.00	\$882.00
Single Cylinder	ML2003	Classroom	\$921.00	\$945.00	\$975.00	\$999.00
	ML2051	Office				
	ML2055	Classroom				
	ML2056	Classroom Holdback				
	ML2057	Storeroom	\$934.00	\$958.00	\$988.00	\$1,012.00
	ML2069	Institution Privacy				
	ML2053	Entrance				
	ML2054	Entrance				
ML2058	Entrance Holdback	\$1,012.00	\$1,035.00			
ML2068	Privacy or Apartment					
Single Cylinder with Deadbolt	ML2024	Entrance	\$957.00	\$981.00	\$1,011.00	\$1,035.00
	ML2048	Entrance				
	ML2059	Security Storeroom				
	ML2065	Dormitory				
	ML2067	Apartment				
	ML2073	Classroom Security				
	ML2075	Entrance/Office				
ML2029	Hotel	\$1,012.00	\$1,036.00	\$1,066.00	\$1,090.00	
Double Cylinder	ML2002	Classroom Intruder	\$1,004.00	\$1,028.00	\$1,058.00	\$1,082.00
	ML2032	Institution				
	ML2042	Entrance				
	ML2052	Classroom Intruder				
Double Cylinder with Deadbolt	ML2022	Store Door	\$1,040.00	\$1,064.00	\$1,094.00	\$1,118.00
	ML2062	Intruder Deadbolt				
	ML2072	Classroom Security Intrude				
	ML2082	Dormitory				
	ML2092	Security Institution				
Full Working Trim (Quick Code M31) No cylinder; includes thumbturn lever			\$735.00	\$759.00	\$789.00	\$813.00

Notes:

- Escutcheon trims are available for 1-3/8", 1-3/4" or 2-1/4" door thicknesses only.
- 613 finish is brass base lever & rose/escutcheon

**Deadbolt Only**

Include lockcase, armored front, strike, screw pack, cylinder(s) and thumbturn lever.

**Ordering Example**

Quantity	Series/Function	Trim Design (Escutcheon Type Only)	Finish	Door Thickness
12	ML2013	N	626	D138

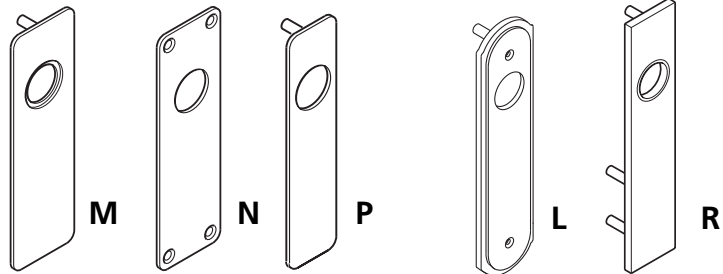

Deadlock No Trim

613E, 626	605, 606, 611, 612, 613, 618, 619, 625, 629, 630, 722
-----------	---

Wrought

M, N, P	
613E, 626	605, 606, 611, 612, 613, 618, 619, 625, 629, 630, 722

Solid Stainless Steel or Forged Brass

L, R	
613E, 626	605, 606, 611, 612, 613, 618, 619, 625, 629, 630, 722

**Function**

Function	Series	613E, 626	605, 606, 611, 612, 613, 618, 619, 625, 629, 630, 722	M, N, P	613E, 626	605, 606, 611, 612, 613, 618, 619, 625, 629, 630, 722	L, R	613E, 626	605, 606, 611, 612, 613, 618, 619, 625, 629, 630, 722
Single Cylinder	ML2011	\$366.00	\$372.00	\$422.00	\$428.00	\$494.00	\$500.00		
Double Cylinder	ML2012	\$449.00	\$455.00	\$533.00	\$539.00	\$622.00	\$628.00		
Cylinder x Thumbturn	ML2013	\$383.00	\$389.00	\$467.00	\$473.00	\$556.00	\$562.00		
Classroom Function Cylinder x Thumbturn	ML2017	\$383.00	\$389.00	\$467.00	\$473.00	\$556.00	\$562.00		

NOTE:  
Escutcheon trims are available for 1 3/8", 1 3/4", or 2 1/4" door thickness only

**Vandal Resistant Trim**

**Lever Designs: CSV, NSV**



**Citation**



**Newport**

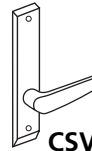
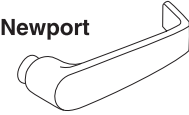

**CSV**

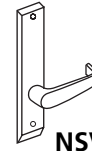

**NSV**

Lever: Cast  
Escutcheon: Cast

**CSV, NSV**

**630**

Function			
Non-Keyed	ML2010VR	Passage	\$1,254.00
	ML2020VR	Privacy	\$1,363.00
	ML2030VR	Privacy	\$1,329.00
	ML2060VR	Privacy	\$1,329.00
Single Cylinder	ML2051VR	Office	\$1,410.00
	ML2055VR	Classroom	
	ML2056VR	Classroom Holdback	
	ML2057VR	Storeroom	
	ML2069VR	Institution Privacy	\$1,423.00
	ML2053VR	Entrance	
	ML2054VR	Entrance	
ML2058VR	Entrance Holdback		
Single Cylinder with Deadbolt	ML2024VR	Entrance	\$1,501.00
	ML2048VR	Entrance	
	ML2059VR	Security Storeroom	
	ML2065VR	Dormitory	
	ML2067VR	Apartment	
	ML2073VR	Classroom Security	
	ML2075VR	Entrance/Office	
Double Cylinder	ML2032VR	Institution	\$1,529.00
	ML2042VR	Entrance	
	ML2052VR	Classroom Intruder	
	ML2022VR	Store Door	
	ML2062VR	Intruder Deadbolt	
	ML2072VR	Classroom Security Intruder	
	ML2082VR	Dormitory	
ML2092VR	Security Institution		
Deadlock	ML2011VR	Single Cylinder	\$1,231.00
	ML2013VR	Cylinder x Thumbturn	
	ML2017VR	Double Cylinder	
	ML2012VR	Double Cylinder	
Full Working Trim (Quick Code M31) No cylinder; includes thumbturn lever			\$1,079.00

NOTE:  
Escutcheon trims are available for 1 3/4", 2", or 2 1/4" door thickness only

**Electrically Controlled Mortise Locksets  
ML20900 Series**



**LWA RWA**

Lever: Wrought  
Rose: Wrought

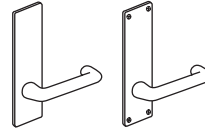

**LWM LWN**

Lever: Wrought  
Escutcheon: Wrought

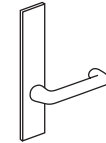

**LWR**

Lever: Wrought  
Escutcheon: Solid Stainless Steel  
or Forged Brass

**Levers: LW, RW  
Roses: A  
Roses: B, F (see note 1)**

**Levers: LW, RW  
Escutcheons: M, N**

**Levers: LW, RW  
Escutcheons: R  
(see note 2)**

Description	Function	Option (See Note)	613E, 630		613E, 626		613E, 626	
			605, 606, 611, 612, 613, 618, 619, 625, 626, 629, 722	605, 606, 611, 612, 613, 618, 619, 625, 629, 630, 722	605, 606, 611, 612, 613, 618, 619, 625, 629, 630, 722	605, 606, 611, 612, 613, 618, 619, 625, 629, 630, 722		
Single Cylinder	ML20914	Fail Safe/Fail Secure	\$951.00	\$975.00	\$971.00	\$995.00	\$1,025.00	\$1,049.00
	ML20906							
No Cylinder Override	ML20907	Fail Safe/Fail Secure	\$868.00	\$892.00	\$888.00	\$912.00	\$942.00	\$966.00
	ML20915							
Double Cylinder	ML20932	Fail Safe/Fail Secure	\$1,034.00	\$1,058.00	\$1,054.00	\$1,078.00	\$1,108.00	\$1,132.00



**ASA CSA LSA**

Lever: Cast  
Rose: Wrought

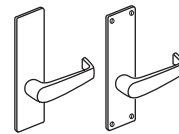

**NSM NSN**

Lever: Cast  
Escutcheon: Wrought

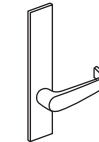

**NSR**

Lever: Cast  
Escutcheon: Solid Stainless Steel  
or Forged Brass

**Levers: AS, CS, LS, NS, PS, RS  
Roses: A  
Roses: B, F (see note 1)**

**Levers: AS, CS, LS, NS, PS, RS  
Escutcheons: M, N**

**Levers: AS, CS, LS, NS, PS, RS  
Escutcheons: R (see note 2)**

Description	Function	Option (See Note)	613E, 626		613E, 626		613E, 626	
			605, 606, 611, 612, 613, 618, 619, 625, 629, 630, 722	605, 606, 611, 612, 613, 618, 619, 625, 629, 630, 722	605, 606, 611, 612, 613, 618, 619, 625, 629, 630, 722	605, 606, 611, 612, 613, 618, 619, 625, 629, 630, 722		
Single Cylinder	ML20914	Fail Safe/Fail Secure	\$1,114.00	\$1,138.00	\$1,134.00	\$1,158.00	\$1,168.00	\$1,192.00
	ML20906							
No Cylinder Override	ML20907	Fail Safe/Fail Secure	\$1,031.00	\$1,055.00	\$1,051.00	\$1,075.00	\$1,085.00	\$1,109.00
	ML20915							
Double Cylinder	ML20932	Fail Safe/Fail Secure	\$1,197.00	\$1,221.00	\$1,217.00	\$1,241.00	\$1,251.00	\$1,275.00

**NOTES:**

1 - Rose substitutions for LWA, LSA, etc.: 2-1/4" cast rose in place of 2-1/4" wrought rose, substitute letter "B" in place of "A" (e.g. LSB). Add \$38.00 per lockset.

2-7/8" cast rose in place of 2-1/4" wrought rose, substitute letter "F" in place of "A" (e.g. LWF). Add \$52.00 per lockset.

2 - "R" Escutcheon trims are available for 1 3/8", 1 3/4" or 2 1/4" door thickness only.

Must Specify: SAF for Fail Safe or SEC for Fail Secure.



**ElectroLynx®**

As part of their promise to provide innovative, fast and effective high security solutions to their customers, certain ASSA ABLOY Group brands offer *ElectroLynx®*, a universal quick-connect system that simplifies the electrification of the door opening.

# Electrified Mortise Lock with High Security Monitoring ML20600 Series NAC

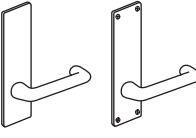
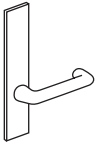
			 <b>LWA    RWA</b> Lever: Wrought Rose: Wrought		 <b>LWM    LWN</b> Lever: Wrought Escutcheon: Wrought		 <b>LWR</b> Lever: Wrought Escutcheon: Solid Stainless Steel or Forged Brass	
			<b>Levers: LW, RW</b> <b>Roses: A</b> Roses: B, F (see note 1)		<b>Levers: LW, RW</b> <b>Escutcheons: M, N</b>		<b>Levers: LW, RW</b> <b>Escutcheons: R</b> (see note 2)	
Description	Function	Option (See Note)	613E, 630	605, 606, 611, 612, 613, 618, 619, 625, 629, 626, 722	613E, 626	605, 606, 611, 612, 613, 618, 619, 625, 629, 630, 722	613E, 626	605, 606, 611, 612, 613, 618, 619, 625, 629, 630, 722
Single Cylinder	ML20606 x NAC	Fail Safe/Fail Secure	\$1,126.00	\$1,150.00	\$1,146.00	\$1,170.00	\$1,200.00	\$1,224.00
	ML20608 x NAC		\$1,201.00	\$1,225.00	\$1,221.00	\$1,245.00	\$1,275.00	\$1,299.00
No Cylinder Override	ML20607 x NAC	Fail Safe/Fail Secure	\$1,043.00	\$1,067.00	\$1,063.00	\$1,087.00	\$1,117.00	\$1,141.00
	ML20609 x NAC		\$1,118.00	\$1,142.00	\$1,138.00	\$1,162.00	\$1,192.00	\$1,216.00

			 <b>ASA    CSA    LSA</b> <b>NSA    PSA    RSA</b> Lever: Cast Rose: Wrought			 <b>NSM    NSN</b> Lever: Cast Escutcheon: Wrought		 <b>NSR</b> Lever: Cast Escutcheon: Solid Stainless Steel or Forged Brass	
			<b>Levers: AS, CS, LS, NS, PS, RS</b> <b>Roses: A</b> Roses: B, F (see note 1)			<b>Levers: AS, CS, LS, NS, PS, RS</b> <b>Escutcheons: M, N</b>		<b>Levers: AS, CS, LS, NS, PS, RS</b> <b>Escutcheons: R</b> (see note 2)	
Description	Function	Option (See Note)	613E, 626	605, 606, 611, 612, 613, 618, 619, 625, 629, 630, 722	613E, 626	605, 606, 611, 612, 613, 618, 619, 625, 629, 630, 722	613E, 626	605, 606, 611, 612, 613, 618, 619, 625, 629, 630, 722	
Single Cylinder	ML20606 x NAC	Fail Safe/Fail Secure	\$1,289.00	\$1,313.00	\$1,309.00	\$1,333.00	\$1,343.00	\$1,367.00	
	ML20608 x NAC		\$1,364.00	\$1,388.00	\$1,384.00	\$1,408.00	\$1,418.00	\$1,442.00	
No Cylinder Override	ML20607 x NAC	Fail Safe/Fail Secure	\$1,031.00	\$1,055.00	\$1,226.00	\$1,250.00	\$1,260.00	\$1,284.00	
	ML20609 x NAC		\$1,106.00	\$1,130.00	\$1,301.00	\$1,325.00	\$1,335.00	\$1,359.00	

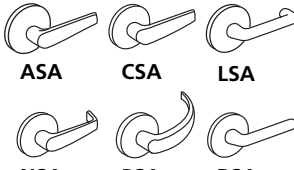
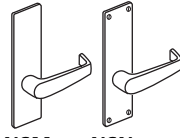
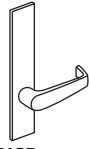
**NOTES:**

1 - Rose substitutions for LWA, LSA, etc.: 2-1/4" cast rose in place of 2-1/4" wrought rose, substitute letter "B" in place of "A" (e.g. LSB). Add \$38.00 per lockset.

2-7/8" cast rose in place of 2-1/4" wrought rose, substitute letter "F" in place of "A" (e.g. LWF). Add \$52.00 per lockset.

2 - "R" Escutcheon trims are available for 1 3/8", 1 3/4" or 2 1/4" door thickness only.

Must Specify: SAF for Fail Safe or SEC for Fail Secure.



**ElectroLynx®**

As part of their promise to provide innovative, fast and effective high security solutions to their customers, certain ASSA ABLOY Group brands offer *ElectroLynx®*, a universal quick-connect system that simplifies the electrification of the door opening.



DSA  
ESA  
Lever: Cast  
Rose: Wrought

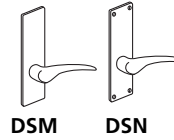

DSM  
DSN  
Lever: Cast  
Escutcheon: Wrought

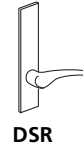

DSR  
Lever: Cast  
Escutcheon: Solid Stainless Steel  
or Forged Brass

**Lever: DS, ES**  
**Roses: A**  
Roses: B, F (see note 1)

**Lever: DS, ES**  
**Escutcheons: M, N**

**Lever: DS, ES**  
**Escutcheons: R (see note 2)**

Description	Function	Option (See Note)	Lever: DS, ES Roses: A Roses: B, F (see note 1)		Lever: DS, ES Escutcheons: M, N		Lever: DS, ES Escutcheons: R (see note 2)	
			613E, 626	605, 606, 611, 612, 613, 618, 619, 625, 629, 630, 722	613E, 626	605, 606, 611, 612, 613, 618, 619, 625, 629, 630, 722	613E, 626	605, 606, 611, 612, 613, 618, 619, 625, 629, 630, 722
Single Cylinder	ML20914	Fail Safe/Fail Secure	\$1,139.00	\$1,163.00	\$1,159.00	\$1,183.00	\$1,193.00	\$1,217.00
	ML20906							
No Cylinder Override	ML20907	Fail Safe/Fail Secure	\$1,056.00	\$1,080.00	\$1,076.00	\$1,100.00	\$1,110.00	\$1,134.00
	ML20915							
Double Cylinder	ML20932	Fail Safe/Fail Secure	\$1,222.00	\$1,246.00	\$1,242.00	\$1,266.00	\$1,276.00	\$1,300.00

**NOTES:**

1 - Rose substitutions for DSA, ESA: 2-1/4" cast rose in place of 2-1/4" wrought rose, substitute letter "B" in place of "A" (e.g.DSB). **Add \$38.00 per lockset.**  
2-7/8" cast rose in place of 2-1/4" wrought rose, substitute letter "F" in place of "A" (e.g. ESF). **Add \$52.00 per lockset.**

2 - "R" Escutcheon trims are available for 1 3/8", 1 3/4", or 2 1/4" door thickness only.

Must Specify: SAF for Fail Safe or SEC for Fail Secure.

**Lever Designs: CSV, NSV**

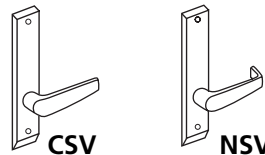

CSV  
NSV  
Lever: Cast  
Escutcheon: Cast

Description	Function	Option (See Note)	CSV, NSV	
			Finish: 630	
Single Cylinder	ML20914	Fail Safe/Fail Secure		\$1,547.00
	ML20906			
No Cylinder Override	ML20907	Fail Safe/Fail Secure		\$1,464.00
	ML20915			
Double Cylinder	ML20932	Fail Safe/Fail Secure		\$1,630.00

**Note:**

Escutcheon trims are available for 1 3/8", 1 3/4", or 2 1/4" door thickness only.

Must Specify: SAF for Fail Safe or SEC for Fail Secure.



**ElectroLynx®**

As part of their promise to provide innovative, fast and effective high security solutions to their customers, certain ASSA ABLOY Group brands offer ElectroLynx®, a universal quick-connect system that simplifies the electrification of the door opening.

# Electrified Mortise Lock with High Security Monitoring ML20600 Series NAC



Lever: Cast  
Rose: Wrought

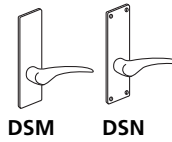

Lever: Cast  
Escutcheon: Wrought

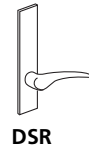

Lever: Cast  
Escutcheon: Solid Stainless Steel  
or Forged Brass

Description	Function	Option (See Note)	Lever: DS, ES Roses: A Roses: B, F (see note 1)		Lever: DS, ES Escutcheons: M, N		Lever: DS, ES Escutcheons: R (see note 2)	
			613E, 626	605, 606, 611, 612, 613, 618, 619, 625, 629, 630, 722	613E, 626	605, 606, 611, 612, 613, 618, 619, 625, 629, 630, 722	613E, 626	605, 606, 611, 612, 613, 618, 619, 625, 629, 630, 722
Single Cylinder	ML20606 x NAC	Fail Safe/Fail Secure	\$1,314.00	\$1,338.00	\$1,334.00	\$1,358.00	\$1,368.00	\$1,392.00
	ML20608 x NAC		\$1,389.00	\$1,413.00	\$1,409.00	\$1,433.00	\$1,443.00	\$1,467.00
No Cylinder Override	ML20607 x NAC	Fail Safe/Fail Secure	\$1,231.00	\$1,255.00	\$1,251.00	\$1,275.00	\$1,285.00	\$1,309.00
	ML20609 x NAC		\$1,306.00	\$1,330.00	\$1,326.00	\$1,350.00	\$1,360.00	\$1,384.00

**NOTES:**

1 - Rose substitutions for DSA, ESA: 2-1/4" cast rose in place of 2-1/4" wrought rose, substitute letter "B" in place of "A" (e.g.DSB). **Add \$38.00 per lockset.**  
2-7/8" cast rose in place of 2-1/4" wrought rose, substitute letter "F" in place of "A" (e.g. ESF). **Add \$52.00 per lockset.**

2 - "R" Escutcheon trims are available for 1 3/8", 1 3/4", or 2 1/4" door thickness only.

Must Specify: SAF for Fail Safe or SEC for Fail Secure.

## Lever Designs: CSV, NSV

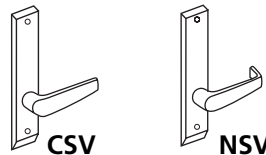

Lever: Cast  
Escutcheon: Cast

Description	Function	Option (See Note)	CSV, NSV	
			Finish: 630	
Single Cylinder	ML20606 x NAC	Fail Safe/Fail Secure	\$1,722.00	
	ML20608 x NAC		\$1,797.00	
No Cylinder Override	ML20607 x NAC	Fail Safe/Fail Secure	\$1,639.00	
	ML20609 x NAC		\$1,714.00	

**Note:**

Escutcheon trims are available for 1 3/8", 1 3/4", or 2 1/4" door thickness only.

Must Specify: SAF for Fail Safe or SEC for Fail Secure.



**ElectroLynx®**

As part of their promise to provide innovative, fast and effective high security solutions to their customers, certain ASSA ABLOY Group brands offer ElectroLynx®, a universal quick-connect system that simplifies the electrification of the door opening.

**Lever Designs: FSG, MSG, ZSG**



**Frascati**



**Lever: Rose:**  
Cast Cast



**FSG**



**MSG**



**ZSG**

Vineyard™  
collection

**Merlot**



**Lever Designs: FSL, MSL, ZSL**



**Zinfandel**

**Lever: Escutcheon:**  
Cast Cast



**FSL**

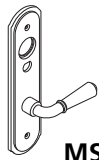

**MSL**

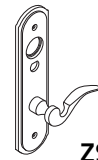

**ZSL**

Vineyard™  
collection



Description	Function	Option (See Note)	FSG, MSG, ZSG		FSL, MSL, ZSL	
			Finish: 613E, 626	Finish: 605, 606, 611, 612, 613 <sup>2</sup> , 613L <sup>2</sup> , 618, 619, 625, 722	Finish: 613E, 626	Finish: 605, 606, 611, 612, 613 <sup>2</sup> , 613L <sup>2</sup> , 618, 619, 625, 722
Single Cylinder	ML20914	Fail Safe/Fail Secure	\$1,139.00	\$1,163.00	\$1,193.00	\$1,217.00
	ML20906					
No Cylinder Override	ML20907	Fail Safe/Fail Secure	\$1,056.00	\$1,080.00	\$1,110.00	\$1,134.00
	ML20915					
Double Cylinder	ML20932	Fail Safe/Fail Secure	\$1,222.00	\$1,246.00	\$1,276.00	\$1,300.00

**Notes:**

- Escutcheon trims are available for 1-3/8", 1-3/4" or 2-1/4" door thicknesses only.
  - 613 finish is brass base lever & rose/escutcheon.
- Must Specify: SAF for Fail Safe or SEC for Fail Secure



**ElectroLynx®**



As part of their promise to provide innovative, fast and effective high security solutions to their customers, certain ASSA ABLOY Group brands offer *ElectroLynx®*, a universal quick-connect system that simplifies the electrification of the door opening.



**Lever Designs: FSG, MSG, ZSG** 

**Lever: Rose:**  
Cast Cast

Vineyard™ collection 

 **FSG**  **MSG**  **ZSG**

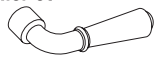

**Frascati** 

**Merlot** 

**Lever Designs: FSL, MSL, ZSL** 

**Lever: Escutcheon:**  
Cast Cast

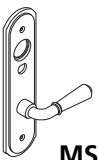
Vineyard™ collection 

 **FSL**  **MSL**  **ZSL**

**Zinfandel** 

Description	Function	Option (See Note)	FSG, MSG, ZSG		FSL, MSL, ZSL	
			Finish: 613E, 626	Finish: 605, 606, 611, 612, 613 <sup>2</sup> , 613L <sup>2</sup> , 618, 619, 625, 722	Finish: 613E, 626	Finish: 605, 606, 611, 612, 613 <sup>2</sup> , 613L <sup>2</sup> , 618, 619, 625, 722
Single Cylinder	ML20606 x NAC	Fail Safe/Fail Secure	\$1,314.00	\$1,338.00	\$1,334.00	\$1,358.00
	ML20608 x NAC		\$1,389.00	\$1,413.00	\$1,409.00	\$1,433.00
No Cylinder Override	ML20607 x NAC	Fail Safe/Fail Secure	\$1,231.00	\$1,255.00	\$1,251.00	\$1,275.00
	ML20609 x NAC		\$1,306.00	\$1,330.00	\$1,326.00	\$1,350.00

Notes:  
 1. Escutcheon trims are available for 1-3/8", 1-3/4" or 2-1/4" door thicknesses only.  
 2. 613 finish is brass base lever & rose/escutcheon.  
 Must Specify: SAF for Fail Safe or SEC for Fail Secure

 **ElectroLynx®**  
 As part of their promise to provide innovative, fast and effective high security solutions to their customers, certain ASSA ABLOY Group brands offer *ElectroLynx®*, a universal quick-connect system that simplifies the electrification of the door opening.

# Electrically Controlled Mortise Locksets

## ML20900 Series

**GRC GRD GRE**

**BRC BRD BRE**

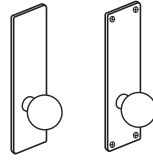
 Knob: Wrought Reinforced  
Rose: Wrought

**GRM GRN**

 Knob: Wrought Reinforced  
Escutcheon: Wrought

**GRR**

 Knob: Wrought Reinforced  
Escutcheon: Solid Stainless  
Steel or Forged Brass

**Knobs: GR, BR  
Roses: C, D, E**
**613E, 626 605, 606, 611, 612, 613,  
618, 619, 625, 722**
**Knobs: GR, BR  
Escutcheons: M, N**
**613E, 626 605, 606, 611, 612, 613,  
618, 619, 625, 722**
**Knobs: GR, BR  
Escutcheons: R (see note)**
**613E, 626 605, 606, 611, 612, 613,  
618, 619, 625, 722**

Description	Function	Option (See Note)	Knobs: GR, BR Roses: C, D, E		Knobs: GR, BR Escutcheons: M, N		Knobs: GR, BR Escutcheons: R (see note)	
			613E, 626	605, 606, 611, 612, 613, 618, 619, 625, 722	613E, 626	605, 606, 611, 612, 613, 618, 619, 625, 722	613E, 626	605, 606, 611, 612, 613, 618, 619, 625, 722
Single Cylinder	ML20914	Fail Safe/ Fail Secure	\$1,146.00	\$1,170.00	\$1,166.00	\$1,190.00	\$1,200.00	\$1,224.00
	ML20906							
No Cylinder Override	ML20907	Fail Safe/ Fail Secure	\$1,063.00	\$1,087.00	\$1,083.00	\$1,107.00	\$1,117.00	\$1,141.00
	ML20915							
Double Cylinder	ML20932	Fail Safe/ Fail Secure	\$1,229.00	\$1,253.00	\$1,249.00	\$1,273.00	\$1,283.00	\$1,307.00

**GWC GWD GWE**

**BWC BWD BRE**

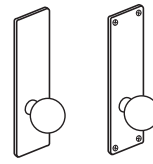
 Knob: Wrought  
Rose: Wrought

**GWM GWN**

 Knob: Wrought  
Escutcheon: Wrought

**GWR**

 Knob: Wrought  
Escutcheon: Solid Stainless  
Steel or Forged Brass

**Knobs: GW, BW  
Roses: C, D, E**
**613E, 626 605, 606, 611, 612, 613,  
618, 619, 625, 722**
**Knobs: GW, BW  
Escutcheons: M, N**
**613E, 626 605, 606, 611, 612, 613,  
618, 619, 625, 722**
**Knobs: GW, BW  
Escutcheons: R (see note)**
**613E, 626 605, 606, 611, 612, 613,  
618, 619, 625, 722**

Description	Function	Option (See Note)	Knobs: GW, BW Roses: C, D, E		Knobs: GW, BW Escutcheons: M, N		Knobs: GW, BW Escutcheons: R (see note)	
			613E, 626	605, 606, 611, 612, 613, 618, 619, 625, 722	613E, 626	605, 606, 611, 612, 613, 618, 619, 625, 722	613E, 626	605, 606, 611, 612, 613, 618, 619, 625, 722
Single Cylinder	ML20914	Fail Safe/ Fail Secure	\$1,088.00	\$1,112.00	\$1,108.00	\$1,132.00	\$1,142.00	\$1,166.00
	ML20906							
No Cylinder Override	ML20907	Fail Safe/ Fail Secure	\$1,005.00	\$1,029.00	\$1,025.00	\$1,049.00	\$1,059.00	\$1,083.00
	ML20915							
Double Cylinder	ML20932	Fail Safe/ Fail Secure	\$1,171.00	\$1,195.00	\$1,191.00	\$1,215.00	\$1,225.00	\$1,249.00

Note: "R" Escutcheon trims are available for 1 3/8", 1 3/4", or 2 1/4" door thickness only.  
Must Specify: SAF for Fail Safe or SEC for Fail Secure.

**ElectroLynx®**

 As part of their promise to provide innovative, fast and effective high security solutions to their customers, certain ASSA ABLOY Group brands offer *ElectroLynx®*, a universal quick-connect system that simplifies the electrification of the door opening.

# Electrified Mortise Lock with High Security Monitoring ML20600 Series NAC



**GRC GRD GRE**



**BRC BRD BRE**

Knob: Wrought Reinforced  
Rose: Wrought

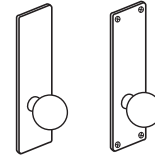

**GRM GRN**

Knob: Wrought Reinforced  
Escutcheon: Wrought



**GRR**

Knob: Wrought Reinforced  
Escutcheon: Solid Stainless  
Steel or Forged Brass

**Knobs: GR, BR  
Roses: C, D, E**

**613E, 626 605, 606, 611, 612, 613,  
618, 619, 625, 722**

**Knobs: GR, BR  
Escutcheons: M, N**

**613E, 626 605, 606, 611, 612, 613,  
618, 619, 625, 722**

**Knobs: GR, BR  
Escutcheons: R (see note)**

**613E, 626 605, 606, 611, 612, 613,  
618, 619, 625, 722**

Description	Function	Option (See Note)	Knobs: GR, BR Roses: C, D, E		Knobs: GR, BR Escutcheons: M, N		Knobs: GR, BR Escutcheons: R (see note)	
			613E, 626	605, 606, 611, 612, 613, 618, 619, 625, 722	613E, 626	605, 606, 611, 612, 613, 618, 619, 625, 722	613E, 626	605, 606, 611, 612, 613, 618, 619, 625, 722
Single Cylinder	ML20606 x NAC	Fail Safe/ Fail Secure	\$1,321.00	\$1,345.00	\$1,341.00	\$1,365.00	\$1,375.00	\$1,399.00
	ML20608 x NAC	Fail Secure	\$1,396.00	\$1,420.00	\$1,416.00	\$1,440.00	\$1,450.00	\$1,474.00
No Cylinder Override	ML20607 x NAC	Fail Safe/ Fail Secure	\$1,238.00	\$1,262.00	\$1,258.00	\$1,282.00	\$1,292.00	\$1,316.00
	ML20609 x NAC	Fail Secure	\$1,313.00	\$1,337.00	\$1,333.00	\$1,357.00	\$1,367.00	\$1,391.00



**GWC GWD GWE**



**BWC BWD BRE**

Knob: Wrought  
Rose: Wrought

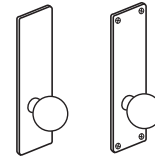

**GWM GWN**

Knob: Wrought  
Escutcheon: Wrought



**GWR**

Knob: Wrought  
Escutcheon: Solid Stainless  
Steel or Forged Brass

**Knobs: GW, BW  
Roses: C, D, E**

**613E, 626 605, 606, 611, 612, 613,  
618, 619, 625, 722**

**Knobs: GW, BW  
Escutcheons: M, N**

**613E, 626 605, 606, 611, 612, 613,  
618, 619, 625, 722**

**Knobs: GW, BW  
Escutcheons: R (see note)**

**613E, 626 605, 606, 611, 612, 613,  
618, 619, 625, 722**

Description	Function	Option (See Note)	Knobs: GW, BW Roses: C, D, E		Knobs: GW, BW Escutcheons: M, N		Knobs: GW, BW Escutcheons: R (see note)	
			613E, 626	605, 606, 611, 612, 613, 618, 619, 625, 722	613E, 626	605, 606, 611, 612, 613, 618, 619, 625, 722	613E, 626	605, 606, 611, 612, 613, 618, 619, 625, 722
Single Cylinder	ML20606 x NAC	Fail Safe/ Fail Secure	\$1,263.00	\$1,287.00	\$1,283.00	\$1,307.00	\$1,317.00	\$1,341.00
	ML20608 x NAC	Fail Secure	\$1,338.00	\$1,362.00	\$1,358.00	\$1,382.00	\$1,392.00	\$1,416.00
No Cylinder Override	ML20607 x NAC	Fail Safe/ Fail Secure	\$1,180.00	\$1,204.00	\$1,200.00	\$1,224.00	\$1,234.00	\$1,258.00
	ML20609 x NAC	Fail Secure	\$1,255.00	\$1,279.00	\$1,275.00	\$1,299.00	\$1,309.00	\$1,333.00

Note: "R" Escutcheon trims are available for 1 3/8", 1 3/4", or 2 1/4" door thickness only.  
Must Specify: SAF for Fail Safe or SEC for Fail Secure.



**ElectroLynx®**

As part of their promise to provide innovative, fast and effective high security solutions to their customers, certain ASSA ABLOY Group brands offer *ElectroLynx®*, a universal quick-connect system that simplifies the electrification of the door opening.

**YWA**

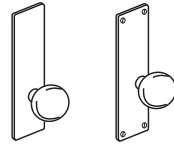
 Knob: Wrought  
Rose: Wrought

**YMM YWN**

 Knob: Wrought  
Escutcheon: Wrought

**YWR**

 Knob: Wrought  
Escutcheon: Solid Stainless Steel or Forged Brass

**Knobs: YW**  
**Roses: A**  
Roses: B, F (see note 1)

**Knobs: YW**  
**Escutcheons: M, N**
**Knobs: YW**  
**Escutcheons: R**

Description	Function	Option (See Note)	Knobs: YW Roses: A Roses: B, F (see note 1)		Knobs: YW Escutcheons: M, N		Knobs: YW Escutcheons: R	
			613E, 626	605, 606, 611, 612, 613, 618, 619, 625, 722	613E, 626	605, 606, 611, 612, 613, 618, 619, 625, 722	613E, 626	605, 606, 611, 612, 613, 618, 619, 625, 722
Single Cylinder	ML20914	Fail Safe/	\$1,146.00	\$1,170.00	\$1,166.00	\$1,190.00	\$1,200.00	\$1,224.00
	ML20906	Fail Secure						
No Cylinder Override	ML20907	Fail Safe/	\$1,063.00	\$1,087.00	\$1,083.00	\$1,107.00	\$1,117.00	\$1,141.00
	ML20915	Fail Secure						
Double Cylinder	ML20932	Fail Safe/ Fail Secure	\$1,229.00	\$1,253.00	\$1,249.00	\$1,273.00	\$1,283.00	\$1,307.00

**GSA**

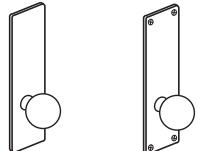
 Knob: Cast  
Rose: Wrought

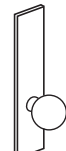
**GSM GSN**

 Knob: Cast  
Escutcheon: Wrought

**GSR**

 Knob: Cast  
Escutcheon: Solid Stainless Steel or Forged Brass

**Knobs: GS**  
**Roses: A**  
Roses: B, F (see note 1)

**Knobs: GS**  
**Escutcheons: M, N**
**Knobs: GS**  
**Escutcheons: R**

Description	Function	Option (See Note)	Knobs: GS Roses: A Roses: B, F (see note 1)		Knobs: GS Escutcheons: M, N		Knobs: GS Escutcheons: R	
			613E, 626	605, 606, 611, 612, 613, 618, 619, 625, 722	613E, 626	605, 606, 611, 612, 613, 618, 619, 625, 722	613E, 626	605, 606, 611, 612, 613, 618, 619, 625, 722
Single Cylinder	ML20914	Fail Safe/	\$1,173.00	\$1,289.00	\$1,285.00	\$1,309.00	\$1,319.00	\$1,343.00
	ML20906	Fail Secure						
No Cylinder Override	ML20907	Fail Safe/	\$1,182.00	\$1,206.00	\$1,202.00	\$1,226.00	\$1,117.00	\$1,260.00
	ML20915	Fail Secure						
Double Cylinder	ML20932	Fail Safe/ Fail Secure	\$1,348.00	\$1,372.00	\$1,368.00	\$1,392.00	\$1,402.00	\$1,426.00

**NOTE:**

Must Specify: SAF for Fail Safe or SEC for Fail Secure.

 1 - Rose substitutions for GSA, YWA: 2-1/4" cast rose in place of 2-1/4" wrought rose, substitute letter "B" in place of "A" (e.g. GSB). **Add \$38.00 per lockset.**  
 2-7/8" cast rose in place of 2-1/4" wrought rose, substitute letter "F" in place of "A" (e.g. YWF). **Add \$52.00 per lockset.**

2 -Escutcheon trims are available for 1 3/8", 1 3/4", or 2 1/4" door thickness only

**ElectroLynx®**

 As part of their promise to provide innovative, fast and effective high security solutions to their customers, certain ASSA ABLOY Group brands offer *ElectroLynx®*, a universal quick-connect system that simplifies the electrification of the door opening.

# Electrified Mortise Lock with High Security Monitoring ML20600 Series NAC

Description	Function	Option (See Note)	YWA		YMM YWN		YWR	
			613E, 626	605, 606, 611, 612, 613, 618, 619, 625, 722	613E, 626	605, 606, 611, 612, 613, 618, 619, 625, 722	613E, 626	605, 606, 611, 612, 613, 618, 619, 625, 722
Single Cylinder	ML20606 x NAC	Fail Safe/	\$1,321.00	\$1,345.00	\$1,341.00	\$1,365.00	\$1,375.00	\$1,399.00
	ML20608 x NAC	Fail Secure	\$1,396.00	\$1,420.00	\$1,416.00	\$1,440.00	\$1,450.00	\$1,474.00
No Cylinder Override	ML20607 x NAC	Fail Safe/	\$1,238.00	\$1,262.00	\$1,258.00	\$1,282.00	\$1,292.00	\$1,316.00
	ML20609 x NAC	Fail Secure	\$1,313.00	\$1,337.00	\$1,333.00	\$1,357.00	\$1,367.00	\$1,391.00



**YWA**

Knob: Wrought  
Rose: Wrought

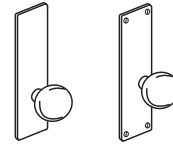

**YMM YWN**

Knob: Wrought  
Escutcheon: Wrought



**YWR**

Knob: Wrought  
Escutcheon: Solid Stainless Steel or Forged Brass

**Knobs: YW**  
**Roses: A**  
Roses: B, F (see note 1)

**Knobs: YW**  
**Escutcheons: M, N**

**Knobs: YW**  
**Escutcheons: R**

Description	Function	Option (See Note)	GSA		GSM GSN		GSR	
			613E, 626	605, 606, 611, 612, 613, 618, 619, 625, 722	613E, 626	605, 606, 611, 612, 613, 618, 619, 625, 722	613E, 626	605, 606, 611, 612, 613, 618, 619, 625, 722
Single Cylinder	ML20606 x NAC	Fail Safe/	\$1,440.00	\$1,464.00	\$1,460.00	\$1,484.00	\$1,494.00	\$1,518.00
	ML20608 x NAC	Fail Secure	\$1,515.00	\$1,539.00	\$1,535.00	\$1,559.00	\$1,569.00	\$1,593.00
No Cylinder Override	ML20607 x NAC	Fail Safe/	\$1,357.00	\$1,381.00	\$1,377.00	\$1,401.00	\$1,411.00	\$1,435.00
	ML20609 x NAC	Fail Secure	\$1,432.00	\$1,456.00	\$1,452.00	\$1,476.00	\$1,486.00	\$1,510.00



**GSA**

Knob: Cast  
Rose: Wrought

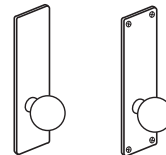

**GSM GSN**

Knob: Cast  
Escutcheon: Wrought



**GSR**

Knob: Cast  
Escutcheon: Solid Stainless Steel or Forged Brass

**Knobs: GS**  
**Roses: A**  
Roses: B, F (see note 1)

**Knobs: GS**  
**Escutcheons: M, N**

**Knobs: GS**  
**Escutcheons: R**

**NOTE:**

Must Specify: SAF for Fail Safe or SEC for Fail Secure.

1 - Rose substitutions for GSA, YWA: 2-1/4" cast rose in place of 2-1/4" wrought rose, substitute letter "B" in place of "A" (e.g.GSB). **Add \$38.00 per lockset.**  
2-7/8" cast rose in place of 2-1/4" wrought rose, substitute letter "F" in place of "A" (e.g. YWF). **Add \$52.00 per lockset.**

2 -Escutcheon trims are available for 1 3/8", 1 3/4", or 2 1/4" door thickness only



**ElectroLynx®**

As part of their promise to provide innovative, fast and effective high security solutions to their customers, certain ASSA ABLOY Group brands offer *ElectroLynx®*, a universal quick-connect system that simplifies the electrification of the door opening.

Fail Safe/Fail Secure	
Description	Specify Quick Code
Fail Safe	SAF
Fail Secure	SEC

Electrified Options for ML20900		
Description	Specify Quick Code	Add or Deduct
Latchbolt Monitor	M91	\$188.00
Request to Exit (REX)	M92	\$186.00
Security monitor	M105	\$327.00
Latchbolt monitor x request to exit	M91 x M92	\$374.00
Request to Exit x security monitor	M92 x M105	\$513.00

Accessories		
Part No.	Description	Add or Deduct
BPS-24-1	Power Supply 24V 1 AMP	\$327.00
BPS-12-1	Power Supply 12V 1 AMP	
BPS-24-2	Power Supply 24V 2 AMP	\$664.00
BPS-12-3	Power Supply 12V 3 AMP	

### ML20600 High Security Monitoring Options

EcoFlex® Mortise Lock End-of-Line Resistors and Deadbolt Privacy Options		
Description	Specify Quick Code	Add or Deduct
Mercury and Lenel compatible 1KΩ/2KΩ resistance supervision	R01	Add \$100.00 per lockset
Software House compatible 1KΩ/2KΩ resistance supervision	R03	Add \$100.00 per lockset
AMAG compatible 4-state supervision	R04	Add \$100.00 per lockset
Deadbolt Privacy Function	PHR	Add \$100.00 per lockset
Deadbolt Privacy and Mercury / Lenel 1KΩ/2KΩ	PHRR01	Add \$200.00 per lockset
Deadbolt Privacy and Software House 1KΩ/2KΩ	PHRR03	Add \$200.00 per lockset
Deadbolt Privacy and AMAG 4-State	PHRR04	Add \$200.00 per lockset

**ElectroLynx®**

As part of their promise to provide innovative, fast and effective high security solutions to their customers, certain ASSA ABLOY Group brands offer *ElectroLynx®*, a universal quick-connect system that simplifies the electrification of the door opening.

**Lock Only**

Includes lockcase, armored front, strike and screw pack. Cylinder(s) and thumbturn lever are not included.

**Ordering Example**

Quantity	Series/Function	Trim See Key Below	Finish	Door Thickness	Optional Strike
12	ML2055	LL	626	D138	SS078

**Trim Key**

KK	Knob x Knob	LK	Lever x Knob	HL	Lever Inside only
LL	Lever x Lever	KL	Knob x Lever	HK	Knob inside Only

Function	Description	LL, LK, KL, HL, HK <sup>2</sup> , KK <sup>2</sup>	
		Available in all listed mortise trim finishes	
Non-Keyed	ML2010	Passage	\$345.00
	ML2020	Privacy	\$419.00
	ML2030	Privacy	
	ML2060	Privacy	
Single Cylinder	ML2051	Office	\$383.00
	ML2003	Classroom	\$396.00
	ML2053	Entrance	
	ML2054	Entrance	\$383.00
	ML2055	Classroom	
	ML2056	Classroom Holdback	
	ML2057	Storeroom	
	ML2058	Entrance Holdback	\$396.00
	ML2068	Privacy and Apartment	\$383.00
ML2069	Institution Privacy		
Single Cylinder with Deadbolt	ML2024	Entrance	\$419.00
	ML2048	Entrance	
	ML2059	Security Storeroom	
	ML2065	Dormitory	
	ML2067	Apartment	\$428.00
	ML2073	Classroom Security	
	ML2075	Entrance/Office	
Double Cylinder	ML2002	Classroom Intruder	\$383.00
	ML2022	Store Door	
	ML2032	Institution	
	ML2042	Entrance	
	ML2052	Classroom Intruder	
	ML2062	Intruder Deadbolt	
	ML2072	Classroom Security Intruder	
	ML2082	Dormitory	
ML2092	Security Institution		
Single Cylinder	ML20914	Fail Safe/Fail Secure	\$601.00
	ML20906		
No Cylinder Override	ML20907	Fail Safe/Fail Secure	
	ML20915		
Double Cylinder	ML20932	Fail Safe/Fail Secure	

**Conversion Kits**

Part Number	Description	Price
683F34	Knob operation to lever operation <sup>1</sup>	\$42.00

Notes: 1. Kits contain internal lock parts only. Order knobs, spindles, escutcheons, cylinders and collars separately.  
2. For master ring, specify quick code MR-LC. Add \$20.00. Not available for ML20900 series.

### Cylinder & Keying Options

Description	Specify Quick Code	Add or Deduct
Conventional 6-pin	(standard)	No Charge
Conventional 7-pin	7P	Add \$2.00 per cylinder
Less Standard Cylinder	LC	Deduct \$83.00 per cylinder
Less Hotel Cylinder	LC	Deduct \$119.00 per cylinder
Less Master Ring Cylinder <sup>3</sup>	MR-LC	Deduct \$40.00 per cylinder
Less Concealed Shell Cylinder	PO-LC	Add \$5.00 per lockset
Access 3 Patented	AP	No Charge
Access 3 Security	AS	Add \$54.00 per cylinder
Access 3 High Security, UL 437	AHS	Add \$76.00 per cylinder
Access 3 IC Patented	ACP	Add \$71.00 per cylinder
Access 3 IC Security	ACS	Add \$120.00 per cylinder
Access 3 IC High Security, UL 437	ACHS	Add \$140.00 per cylinder
Pyramid Security Fixed Core <sup>2</sup>	PS	Add \$55.00 per cylinder
Pyramid Security IC <sup>2</sup>	PCS	Add \$124.00 per cylinder
Pyramid High Security Fixed Core <sup>2</sup>	PHS	Add \$82.00 per cylinder
Pyramid High Security IC <sup>2</sup>	PCHS	Add \$152.00 per cylinder
Pyramid IC with Temporary Construction Core <sup>2,4</sup>	CTP	Add \$71.00 per cylinder
Pyramid IC with Temporary Disposable Core <sup>2,4</sup>	CTPD	No Charge
Pyramid IC Less Core <sup>2</sup>	CLP	No Charge
Security <sup>5</sup>	HS	Add \$106.00 per cylinder
Security IC <sup>1,5</sup>	CHS	Add \$176.00 per cylinder
Blockout Function Cylinder	BO	Add \$105.00 per cylinder
IC 6-pin	C6	Add \$71.00 per cylinder
IC 6-pin with Temporary Construction Core (Red)	CT6R	Add \$71.00 per cylinder
IC 6-pin with Temporary Construction Core (Blue)	CT6B	Add \$71.00 per cylinder
IC 6-pin with Temporary Construction Core (Green)	CT6G	Add \$71.00 per cylinder
IC 6-pin with Temporary Disposable Core	CT6D	No Charge
IC 6-pin Less Core	CL6	No Charge
SFIC 6-pin with Less Core <sup>2</sup>	CLS6	No Charge
IC 6-pin with SFIC disposable temporary core <sup>2</sup>	CT6SD	No Charge
IC 7-pin <sup>2</sup>	C7	Add \$73.00 per cylinder
IC 7-pin with Temporary Construction Core (Red) <sup>2</sup>	CT7R	Add \$73.00 per cylinder
IC 7-pin with Temporary Construction Core (Blue) <sup>2</sup>	CT7B	Add \$73.00 per cylinder
IC 7-pin with Temporary Construction Core (Green) <sup>2</sup>	CT7G	Add \$73.00 per cylinder
IC 7-pin with Temporary Disposable Core <sup>2</sup>	CT7D	Add \$2.00 per cylinder
IC 7-pin Less Core <sup>2</sup>	CL7	Add \$2.00 per cylinder
SFIC 7-pin with Less Core <sup>2</sup>	CLS7	Add \$2.00 per cylinder
IC 7-pin with SFIC disposable temporary core <sup>2</sup>	CT7SD	Add \$2.00 per cylinder
Master Ring <sup>3</sup>	MR	Add \$65.00 per cylinder
Flex Head Cylinder, 6-pin (sectional trim)	FX6	Add \$69.00 per cylinder
Flex Head Cylinder, 7-pin (sectional trim)	FX7	Add \$72.00 per cylinder
Flex Head Master Ring (sectional trim)	FXM	Add \$118.00 per cylinder
Plug only to show, 6-pin (concealed shell) (available for M and R escutcheons and single cylinder functions only)	P06	Add \$85.00 per lockset
Plug only to show, 7-pin (concealed shell) (available for M and R escutcheons and single cylinder functions only)	P07	Add \$87.00 per lockset
Laser Engraving	LASER	Add \$20.00 per lockset

**Notes:**

1. CHS ordered with CT6 option no charge.
2. Pyramid series and IC-7 pin are not available in ML2029 function.
3. Available for "M" escutcheon and sectional trim only. Not available for 17, 29 or 32 functions, and ECL functions. Not available for ML20900 series.
4. Refer to Key construction core program, pg. 63 for example of CTP option pricing.
5. For existing systems only.



**Cylinder & Keying Options\* (con't)**

Description	Specify Quick Code	Add or Deduct
0-Bitted with two blank keys <sup>5</sup>	(standard)	No Charge
Keyed Random <sup>4</sup>	KR	No Charge
Master keyed (all cylinders except 8000, 8020, 8027 IC core)	specify keyset	Add \$16.00 per cylinder
Master keyed Pyramid	specify keyset	Add \$16.00 per cylinder
Master keyed Security (including IC cylinder and core)	specify keyset	Add \$16.00 per cylinder
Master keyed (8000, 8020, 8027 IC core)	specify keyset	No Charge
Master keyed to customer bittings or sample key	specify keyset	Add \$16.00 per cylinder
Construction master keyed <sup>1,2</sup>	CMK	Add \$16.00 per cylinder
Visual key control (VKC)		
- No Stamping	VKC0	\$4.50
- Keys only	VKC1	No Charge
- Cylinders and Keys <sup>3</sup>	VKC2	\$8.00
- Cylinders only <sup>3</sup>	VKC3	\$8.00
Concealed key control (CKC)		
- CKC cylinders with VKC keys	CKC2	\$8.00
- CKC cylinders only <sup>3</sup>	CKC3	\$8.00
More than 2 keys per lock	KY# (e.g., KY6)	See page 66 - Cut Keys Section

\*Double Cylinder Keying: Unless otherwise specified, both cylinders of ML2012, 2022, 2032, 2052, 2062, 2072, 2082, 2092 function locks will be keyed alike. The inside cylinder of 42 function locks will be keyed to the master key(s) only, while the outside cylinder will include the change key. If different is required, specify outside cylinder first, then inside cylinder. For key bows other than 10 and 90, specify "KB" + bow number as Quick Code, e.g. KB12. No extra charge.

**Notes:**

1. CMK Construction master keying charge is in addition to master keying charge.
2. CMK Construction master keying is not available in Pyramid series cylinders.
3. VKC2, VKC3, CKC3 are not available in Pyramid or Security series.
4. Pyramid series is not available keyed random.
5. Security series is not available 0-bitted.

**Strike Options\***

(To purchase strike separately, see catalog or parts manual for part no.)

Lip Length	ANSI Straight Lip - Specify Quick Code	ANSI Curved Lip - Specify Quick Code	Add or Deduct
7/8"	SS078	N/A	No Charge
1-1/8"	(standard)	N/A	
1-1/4"	SS114	SA114	
1-3/8"	SS138	SA138	
1-1/2"	SS112	SA112	
1-3/4"	SS134	SA134	Add \$16.00 per lockset
2"	SS200	SA200	
2-1/4"	SS214	SA214	
2-1/2"	SS212	SA212	
2-3/4"	SS234	SA234	
3"	SS300	SA300	

Description	Door Thickness	Specify Quick Code	Add or Deduct
Open Back Strike	1-3/4"	SB134	Add \$82.00 per lockset
Open Back Strike	2"	SB200	Add \$124.00 per lockset
Open Back Strike	2-1/4"	SB214	
Rabbeted front and strike		SR118	Add \$86.00 per lockset

\* If door thickness is standard or has been specified and no special door or frame condition exist, then only the first two characters of the optional strike Quick Code must be specified (e.g. "SA").

The correct lip length will be determined by our order entry system based on the standard or specified door thickness.

### Door Thickness with Locksets Mortised on Center

(Note: Door thickness with panel not to exceed 2" from centerline of lock.)

Door Thickness	Sectional Rose Trim Specify Quick Code	Escutcheon <sup>1,2</sup> Trim Specify Quick Code	Add or Deduct
1-3/4" (standard)	—	—	No Charge
1-3/8"	D138	D138	Add \$56
1-7/8"	D178	N/A	No Charge
2"	D200	D200	
2-1/8"	D218	N/A	
2-1/4"	D214	D214	
2-3/8"	D238	D238	Add \$92.00 per lockset
2-1/2"	D212	D212	
2-5/8"	D258	D258	
2-3/4"	D234	D234	
2-7/8"	D278	D278	
3"	D300	D300	
3-1/8"	D318	D318	
3-1/4"	D314	D314	
3-3/8"	D338	D338	
3-1/2"	D312	D312	
3-5/8"	D358	D358	
3-3/4"	D334	D334	
3-7/8"	D378	D378	
4"	D400	D400	

**Notes:**

- For 2-3/8" to 4" door thickness: throughbolts and thumbturn lever spindle for 4" door will be provided. Throughbolts and spindles may be field cut.
- "VR" and "T" escutcheons are only available for 1-3/8", 1-3/4" and 2-1/4" door thicknesses.

### Panel Applications

Specify Quick Code	Description	Add or Deduct
PNL1	Centerline of lockcase to edge of panel not to exceed 2"	Add \$92.00 per lockset

**Note:**

- When ordering, specify door thickness (less panel), panel thickness, and side of door panel will be applied (outside or inside).

### Custom Laser Engraving- LASER

**Laser engraving processing charge (all engraving types)**

- \$250 net per order. Charge will be applied to production order when placed.

**Single Vanity, Logo or Other (same engraving on all parts)**

- Lever - \$10 net add each
- Mortise Escutcheon - \$10 net add each
- HPSK Paddle - \$10 net add each

**Unique laser engraving (i.e. Room Number, Apartment Number, etc)**

- \$12 net add each (per piece)

**Miscellaneous Options**

Description	Specify Quick Code	Add or Deduct
Split designs and split finishes	Outside Trim x Inside Trim	Higher set price prevails
Spanner head screws	M02	Add \$16.00 per lockset
Torx® head screws (n/a with N escutcheon)	M04	Add \$22.00 per lockset
ANSI wrought strike box	M17	No Charge
Occupancy indicator (hotel function only)	M19	No Charge
Single Occupancy Indicator - Secure/Unsecure (Outside)	M19S*	Add \$85.00 per lockset
Single Occupancy Indicator - Vacant/Occupied (Outside)	M19V*	Add \$85.00 per lockset
Single Occupancy Indicator - Secure/Unsecure (Inside)	M19N*	Add \$85.00 per lockset
Double Occupancy Indicator - Secure/Unsecure (Outside)	M19SN*	Add \$162.00 per lockset
Double Indicator Vacant/Occupied (Outside)	M19VN*	Add \$162.00 per lockset
Knurling outside and inside	M20 <sup>1</sup>	Add \$132.00 per lockset
Knurling outside only	M21 <sup>1</sup>	Add \$66.00 per lockset
Knurling inside only	M22 <sup>1</sup>	Add \$66.00 per lockset
Abrasive coat outside and inside	M23 <sup>1</sup>	Add \$82.00 per lockset
Abrasive coat inside only	M24 <sup>1</sup>	Add \$41.00 per lockset
Abrasive coat outside only	M25 <sup>1</sup>	Add \$41.00 per lockset
Non-ferrous lockcase	M26	Add \$208.00 per lockset
Lead wrapped case	M29	Add \$252.00 per lockset
Half trim (for ML2010, ML2020, ML2022, ML2024, ML2029, ML2030, ML2032, ML2052, ML2053, ML2055, ML2056, ML2057, ML2058, ML2059, ML2062, ML2065 only) supplied with inside trim only	M30**	Deduct \$40.00 per lockset
Working trim only	M31	See pages 101 thru 111
Latch Hold Back 42, 51, 52, 55, 57 functions	LHB	Add \$40.00 per lockset
HPSK Positive Pull Stop Kit (813F068)		Add \$16.00
HPSK "PUSH" & "PULL" Identification (non-handed)	M38	Add \$20.00
HPSK Security Lever (not available on non-keyed functions)	M111	No Charge

\*Refer to ML2000 catalog for available indicators by locking function. Not available w/ BHSS or BLSS trim.

\*\*Not available with BHSS trim. Requires special application for BLSS, HSS, and HPSK trim.

**Thumbturn Options**

Specify door thickness	Specify Quick Code	Add or Deduct
Ergonomic	M34 <sup>2</sup>	Add \$14.00 per TT
Decorative	MT1	No Charge
Decorative square	MT2	No Charge
Decorative cylinder	MT3	No Charge

**MT1**

**MT2**

**MT3**

Notes:

1. Not available on Vineyard™ Collection.
2. M34 is not available with M19N, M19VN or M19SN.

Note: Thumbturn backplate will match shape of rose chosen (i.e. round or square)



ASSA ABLOY

Blank Page



Look for the  *MicroShield* icon.

**MicroShield®**

As part of their promise to provide innovative solutions to their customers, certain ASSA ABLOY Group brands offer the MicroShield® technology, a silver-based antimicrobial coating designed to inhibit the growth of bacteria.

MicroShield® is a registered trademark of Yale Security Inc., an ASSA ABLOY Group company.

Product	Trim	MicroShield® Coated Components
Specialty Hardware	BHSS, BLSS, BHD, HPSK	Knobs/Levers, roses and/or escutcheons

**AVAILABLE FINISHES**

- MicroShield® is available on 626 and 630. Other finishes available by Special Product Application Request Form only.
- Specify 626C (satin chrome plated) or 630C (satin stainless steel) when ordering.
- MicroShield® coating will be applied over 626 and 630 finishes. All components will match 626.

*Note: MicroShield® coating will only be applied to "high touch" components.*

**HOW TO ORDER**

Product	How to Order
Mortise Locks	ML2055 x BHSS x 626C x RHR

Description	Add
Cylindrical Locks & Mortise Locks	Add \$62.00

**Behavioral Health Series™**

**Lever Design: BHSS**

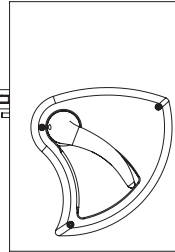

**BHSS**

Lever: Cast  
Escutcheon: Cast

			630	629
Non-Keyed	ML2010	Passage	\$1,544.00	\$1,568.00
	ML2020	Privacy	\$1,663.00	\$1,687.00
	ML2030	Privacy		
	ML2060	Privacy	\$1,601.00	\$1,625.00
Single Cylinder	ML2003	Classroom	\$1,679.00	\$1,703.00
	ML2051	Office		
	ML2055	Classroom		
	ML2056	Classroom HB		
	ML2057	Storeroom		
	ML2069	Institution Privacy	\$1,696.00	\$1,720.00
	ML2053	Entrance		
	ML2054	Entrance		
ML2058	Entrance Holdback			
ML2068	Privacy or Apartment			
Single Cylinder with Deadbolt	ML2024	Entrance	\$1,715.00	\$1,739.00
	ML2048	Entrance		
	ML2065	Dormitory		
	ML2059	Security Storeroom		
	ML2067	Apartment		
	ML2073	Classroom Security		
	ML2075	Entrance/Office		
	ML2029	Hotel	\$1,770.00	\$1,794.00
Double Cylinder	ML2002	Classroom Intruder	\$1,762.00	\$1,786.00
	ML2032	Institution		
	ML2042	Entrance		
	ML2052	Classroom Intruder		
Double Cylinder with Deadbolt	ML2022	Store Door	\$1,798.00	\$1,822.00
	ML2062	Intruder Deadbolt		
	ML2072	Classroom Security Intruder		
	ML2082	Dormitory		
	ML2092	Security Institution		
Single Cylinder	ML20906	Fail Safe/Fail Secure	\$1,897.00	\$1,921.00
	ML20914			
No Cylinder Override	ML20907	Fail Safe/Fail Secure	\$1,814.00	\$1,838.00
	ML20915			
Double Cylinder	ML20932	Fail Safe/Fail Secure	\$1,980.00	\$2,004.00
Full Working Trim	M31	No cylinder; includes thumbturn lever	\$1,199.00	\$1,223.00

**Behavioral Health Series™**

**Lever Design: BLSS**

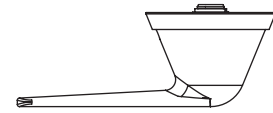
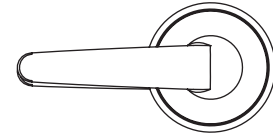

**BLSS**

Lever: Cast  
Rose: Wrought

			630	629
Non-Keyed	ML2010	Passage	\$1,482.00	\$1,506.00
	ML2030	Privacy	\$1,601.00	\$1,625.00
	ML2060	Privacy	\$1,539.00	\$1,563.00
Single Cylinder	ML2055	Classroom	\$1,617.00	\$1,641.00
	ML2057	Storeroom		
	ML2069	Institution Privacy	\$1,634.00	\$1,658.00
	ML2054	Entrance		
Single Cylinder with Deadbolt	ML2024	Entrance	\$1,653.00	\$1,677.00
	ML2065	Dormitory		
	ML2067	Apartment		
Double Cylinder	ML2032	Institution	\$1,700.00	\$1,724.00
	ML2042	Entrance		
	ML2052	Classroom Intruder		
Double Cylinder with Deadbolt	ML2022	Store Door	\$1,736.00	\$1,760.00
	ML2062	Intruder Deadbolt		
Single Cylinder	ML20906	Fail Safe/Fail Secure	\$1,835.00	\$1,859.00
	ML20914			
No Cylinder Override	ML20907	Fail Safe/Fail Secure	\$1,752.00	\$1,776.00
	ML20915			
Double Cylinder	ML20932	Fail Safe/Fail Secure	\$1,918.00	\$1,942.00
Full Working Trim	M31	No cylinder; includes thumbturn lever	\$1,137.00	\$1,161.00

**Anti-Harm Knob Trim**

**Knob Design: HSS**



**HSS** Knob: Brass

**HSS<sup>1</sup>**

**606, 626**

Function			
Non-Keyed	ML2010	Passage	\$1,280.00
	ML2020	Privacy	\$1,694.00
	ML2060	Privacy	\$1,660.00
	ML2090	Full Active Dummy Trim	\$1,309.00
Single Cylinder	ML2003	Classroom	\$1,741.00
	ML2051	Office	
	ML2055	Classroom	
	ML2056	Classroom Holdback	
	ML2057	Storeroom	\$1,756.00
	ML2069	Institution Privacy	
	ML2053	Entrance	
	ML2054	Entrance	
Single Cylinder with Deadbolt	ML2058	Entrance Holdback	\$1,777.00
	ML2068	Privacy or Apartment	
Double Cylinder	ML2024	Entrance	\$1,824.00
	ML2002	Classroom Intruder	
	ML2032	Institution	
	ML2042	Entrance	
Double Cylinder with Deadbolt	ML2052	Classroom Intruder	\$1,860.00
	ML2022	Store Door	
Deadlock	ML2092	Security Institution	\$571.00
	ML2011	Single Cylinder	
	ML2012	Double Cylinder	
	ML2013	Cylinder x Thumbturn	
Single Cylinder	ML2017	Classroom Function	\$1,959.00
	ML20906	Cylinder x Thumbturn	
Single Cylinder	ML20914	Fail Safe/Fail Secure	\$1,876.00
	ML20907	Fail Safe/Fail Secure	
No Cylinder Override	ML20915	Fail Safe/Fail Secure	\$2,042.00
	ML20932	Fail Safe/Fail Secure	

Notes:  
1. Sectional lever trim x HSS available.



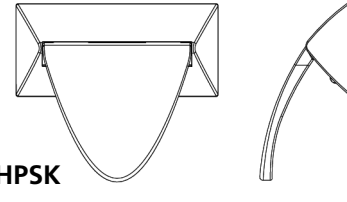

**HPSK**

Lever: Cast  
Rose: Wrought

Function			613E, 630	605, 606, 611, 612, 613, 618, 619, 629, 722
Non-Keyed	ML2010	Passage	\$956.00	\$980.00
	ML2020	Privacy	\$988.00	\$1,012.00
	ML2030	Privacy		
	ML2060	Privacy	\$984.00	\$1,008.00
Single Cylinder	ML2003	Classroom	\$1,067.00	\$1,091.00
	ML2051	Office		
	ML2055	Classroom		
	ML2056	Classroom		
	ML2057	Storeroom		
	ML2069	Institution Privacy		
	ML2053	Entrance	\$1,080.00	\$1,104.00
	ML2054	Entrance		
	ML2058	Entrance Holdback		
ML2068	Privacy or Apartment			
Single Cylinder with Deadbolt	ML2024	Entrance	\$1,103.00	\$1,127.00
	ML2048	Entrance		
	ML2065	Dormitory		
	ML2059	Security Storeroom		
	ML2067	Apartment		
	ML2073	Classroom Security		
	ML2075	Entrance/Office		
ML2029	Hotel	\$1,158.00	\$1,182.00	
Double Cylinder	ML2002	Classroom Intruder	\$1,150.00	\$1,174.00
	ML2032	Institution		
	ML2042	Entrance		
	ML2052	Classroom Intruder		
Double Cylinder with Deadbolt	ML2022	Store Door	\$1,233.00	\$1,257.00
	ML2062	Intruder Deadbolt		
	ML2072	Classroom Security Intruder		
	ML2082	Dormitory		
	ML2092	Security Institution		
Single Cylinder	ML20906	Fail Safe/Fail Secure	\$1,285.00	\$1,309.00
	ML20914			
No Cylinder Override	ML20907	Fail Safe/Fail Secure	\$1,202.00	\$1,226.00
	ML20915			
Double Cylinder	ML20932	Fail Safe/Fail Secure	\$1,309.00	\$1,392.00
Full Working Trim	M31	No cylinder, includes thumbturn lever	\$562.00	\$586.00

**Standard Features**

**Handing**

Passage (HP3010) function is non-handed  
Privacy (HP3020) function is handed

**Door Thickness**

1-3/4" (44mm) standard.  
Optional door thicknesses available

**Backset (5" - Standard)**

5" (127mm) standard.  
Optional: 2-3/4" (70mm) and 7" (177mm)

**Strike**

ANSI curved lip strike standard, 4-7/8" x 1-1/4" x 1-1/4" lip to center.

Optional strikes, lip lengths and ANSI wrought strike box available

**Latchbolt**

Brass, 1/2" (13mm) throw

**Covers**

Cast stainless steel or brass

**Paddles**

Cast stainless steel or brass



**Ordering Example**

**Stock Order**

Series/Function	Trim	Finish	Hand*
HP3010	HPSK	630	RH

Passage (HP3010) function is non-handed and privacy (HP3020) function is handed.

Function	Description	Finish	Finish
		613E, 630	605, 606, 611, 612, 613, 613L, 618, 619, 629, 722
HP3010	Passage	\$418.00	\$430.00
HP3020	Privacy	\$542.00	\$554.00

## Strike Options

Lip to Center	ANSI Curved Lip. Specify	Curved Lip Box. Specify	Full Lip. Specify	Add or Deduct
1" (25mm)	SA100	SC100		No Charge
1-1/8" (29mm)	SA118	SC118		
1-1/4" (32mm)	(standard)	SC114	SF114*	
1-3/8" (35mm)	SA138	SC138		
1-1/2" (38mm)	SA112	SC112		
1-3/4" (44mm)	SA134	SC134		Add \$16.00 per lockset
2" (51mm)	SA200	SC200		
2-1/4" (57mm)	SA214	SC214		
2-1/2" (63mm)	SA212	SC212		
2-3/4" (70mm)	SA234	SC234		
3" (76mm)	SA300	SC300		

\* Specify SFR114 for rounded corner.

## Door Thickness Options

Description	Specify Quick Code	Add or Deduct
1-3/4" (44mm)	(standard)	No Charge
2" (51mm)	D200	
2-1/4" (57mm)	D214	

## Backset Options

Description	Specify Quick Code	Add or Deduct
2-3/4" (70mm)	B234	No Charge
5" (127mm)	(standard)	
7" (177mm)	B700	Add \$6.00 per lockset

## Miscellaneous Options

Description	Specify Quick Code	Add or Deduct
Spanner head screws	M02	Add \$16.00 per lockset
Torx® head screws	M04	Add \$22.00 per lockset
Latch front, rounded corners	M13	Add \$2.50 per latch
ANSI wrought strike box	M17	No Charge
Lead lining. Specify Push or Pull side.	M28	Add \$262.00 per lockset
"PUSH & PULL" Identification*	M38	Add \$20.00
Retrofit Kit (part no. 791F39)		Add \$52.00
HP3000 Positive Pull Stop Kit (813F068)		Add \$16.00



CL3100  
CL3300  
CL3500  
CL3800

**MicroShield®**

As part of their promise to provide innovative solutions to their customers, certain ASSA ABLOY Group brands offer the MicroShield® technology, a silver-based antimicrobial coating designed to inhibit the growth of bacteria.

MicroShield® is a registered trademark of Yale Security Inc., an ASSA ABLOY Group company.

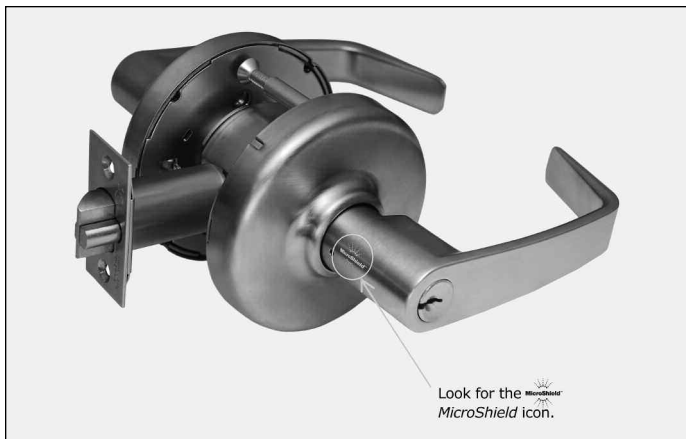

Product	Series	MicroShield® Coated Components
Cylindrical Locks	CL3100, CL3300, CL3500, and CL3800 Series	Levers*, roses

**AVAILABLE FINISHES**

- MicroShield® is available on 626. Other finishes available by Special Product Application Request Form only.
- Specify 626C (satin chrome plated) when ordering.
- MicroShield® coating will be applied over 626 finish. All components will match 626.

\* MicroShield® coating will only be applied to "high touch" components.

**HOW TO ORDER**

Product	How to Order
Cylindrical Locks	CL3355 x NZD x 626C

Description	Add
Cylindrical Locks	Add \$62.00

**Standard Features**

**Handing**

Non-handed

**Door Thickness**

1-3/4" - 2 standard

**Backset**

2-3/4" standard

**Strike**

ANSI curved lip  
4-7/8" x 1-1/4" x 1-1/4" lip to center

**Cylinder**

Brass, 6-pin, L4 keyway, 0-bitted

**Keys**

Two nickel silver keys

**Case Quantity**

6

**Case Weight**

32 lbs

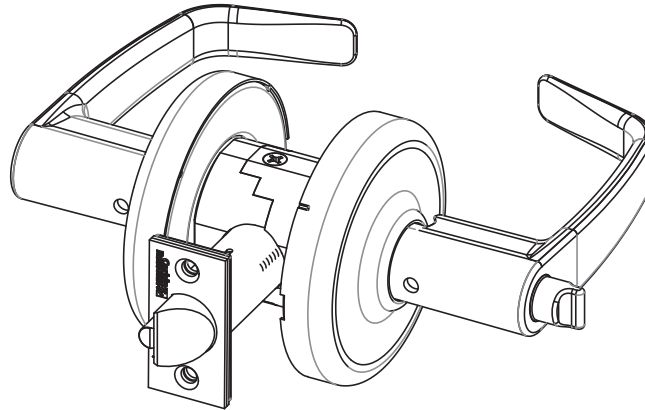

**Ordering Examples**

**Stock Order**

Quantity	Series/Function	Trim	Finish	Hand
100	CL3155	NZD	626	RHR

**Split Finish Order**

Quantity	Series/Function	Finish		Hand
		Outside	Inside	
12	CL3155	626	625	RHR

**Note:** Higher set price prevails

**Contract/Detailed Order**

Quantity	Keyset	Series/Function	Trim	Finish	Hand	Strike	Misc. Options	Cylinder and Keying
24	AA1	CL3155	NZD	626	RHR	SA112	M17	C6-VKC3

**Lever Designs:**



**Levers**

**Roses**

**Lever:**

Die cast zinc

**Rose:**

Brass

**Newport**



**Armstrong**

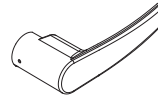

**Princeton**



C ROSE



D ROSE

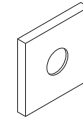

E ROSE



K ROSE

Function	Description		AZC, AZD, AZE, AZK, NZC, NZD, NZE, NZK, PZC, PZD, PZE, PZK	
			Finish: 613E, 626	Finish: 605, 606, 611, 612, 613, 618, 619, 625, 722
CL3110	Non-Keyed	Passage	\$461.00	\$477.00
CL3120		Privacy	\$525.00	\$541.00
CL3120H		Hospital Privacy		
CL3140NT		Exit Latch		
CL3150		Half Dummy		
CL3170		Full Dummy		
CL3180		Passage x blank plate		
CL3151	Single Cylinder	Entrance	\$619.00	\$635.00
CL3155		Classroom		
CL3157		Storeroom		
CL3161		Entrance	\$633.00	\$649.00
CL3175		Corridor/dormitory	\$695.00	\$711.00
CL3193		Service Station		
CL3129		Hotel		
CL3132	Double Cylinder	Institution	\$706.00	\$722.00
CL3152		Classroom Intruder		
CL3162		Communicating		
CL3172		Public Toilet		

<b>Cylinder Options</b>		
Description	Specify Quick Code	Add or Deduct
Conventional 6-pin	(standard)	No Charge
Conventional 7-pin	7P	Add \$2.00 per cylinder
Less Cylinder <sup>4</sup>	LC	Deduct \$76.00 per cylinder
Access 3 Patented	AP	No Charge
Access 3 Security	AS	Add \$54.00 per cylinder
Access 3 High Security, UL 437	AHS	Add \$76.00 per cylinder
Access 3 IC Patented	ACP	Add \$71.00 per cylinder
Access 3 IC Security	ACS	Add \$120.00 per cylinder
Access 3 IC High Security, UL 437	ACHS	Add \$140.00 per cylinder
Pyramid Security Fixed Core <sup>3</sup>	PS	Add \$55.00 per cylinder
Pyramid Security IC <sup>3</sup>	PCS	Add \$124.00 per cylinder
Pyramid High Security Fixed Core <sup>3</sup>	PHS	Add \$82.00 per cylinder
Pyramid High Security IC <sup>3</sup>	PCHS	Add \$152.00 per cylinder
Pyramid IC with Temporary Construction Core	CTP	Add \$71.00 per cylinder
Pyramid IC with Temporary Disposable Core	CTPD	No Charge
Pyramid IC Less Core	CLP	No Charge
Security <sup>3</sup>	HS	Add \$105.00 per cylinder
Security IC <sup>3</sup>	CHS	Add \$176.00 per cylinder
IC 6-pin	C6	Add \$71.00 per cylinder
IC 6-pin with Temporary Construction Core (Red)	CT6R	Add \$71.00 per cylinder
IC 6-pin with Temporary Construction Core (Blue)	CT6B	Add \$71.00 per cylinder
IC 6-pin with Temporary Construction Core (Green)	CT6G	Add \$71.00 per cylinder
IC 6-pin with Temporary Disposable Core	CT6D	No Charge
Small Format Temporary Disposable Core	CTSD	No Charge
IC 6-pin Less Core <sup>3</sup>	CL6	No Charge
IC 7-pin	C7	Add \$73.00 per cylinder
IC 7-pin with Temporary Construction Core (Red)	CT7R	Add \$73.00 per cylinder
IC 7-pin with Temporary Construction Core (Blue)	CT7B	Add \$73.00 per cylinder
IC 7-pin with Temporary Construction Core (Green)	CT7G	Add \$73.00 per cylinder
IC 7-pin with Temporary Disposable Core	CT7D	No Charge
IC 7-pin Less Core <sup>3</sup>	CL7	
Lockset furnished in Schlage® C Keyway <sup>1, 3</sup>	C	
Lockset furnished in Sargent® LA Keyway <sup>2, 3</sup>	LA	

**Notes:**

1. Available 0-bitted & key random (KR) only.
2. Available 0-bitted only.
3. Not available in CL3129 function.
4. CL3129 function is not available less cylinder.

### Keying Options\*

Description	Specify Quick Code	Add or Deduct
0-Bitted with 2 blank keys	(standard)	No Charge
Keyed random	KR	
Master keyed (all cylinders except 8000, 8020, 8027 IC core)	Specify keyset	Add \$16.00 per cylinder
Master keyed Pyramid	Specify keyset	
Master keyed Security (including IC cylinder and core)	Specify keyset	
Master keyed (8000, 8020, 8027 IC core)	Specify keyset	No Charge
Master keyed to customer bittings or sample key	Specify keyset	Add \$16.00 per cylinder
Construction master keyed <sup>1,2</sup>	CMK	Add \$16.00 per cylinder
Visual key control (VKC)		
-No stamping	VKC0	\$4.50
-Keys only	VKC1	No Charge
-Cylinder and Keys <sup>3</sup>	VKC2	\$8.00
-Cylinders only <sup>3</sup>	VKC3	\$8.00
Concealed key control (CKC)		
-CKC cylinders with VKC keys	CKC2	\$8.00
-CKC cylinders only <sup>3</sup>	CKC3	\$8.00
More than 2 keys per lock	KY# (e.g., KY6)	See page 66 - Cut Keys Section

Notes:

1. CMK Construction master keying charge is in addition to master keying charge.
2. CMK Construction master keying is not available in Pyramid or Security series.
3. VKC2, VKC3, CKC3 are not available in Access 3, Pyramid or Security series.

\*Double cylinder keying: unless otherwise specified, both cylinders of 32, 52 and 62 functions will be keyed alike. The inside cylinder of 72 function will be keyed to the master key(s) only, while the outside cylinder will include the change key.

If different keying is required, specify outside cylinder first, then inside cylinder.

For key bows other than 10 and 90, specify 'KB' + bow number as Quick Code, e.g. KB12.



**Door Thickness Options**

Description	Specify Quick Code	Add or Deduct
1-3/4" - 2"	(standard)	No Charge
Over 2" up to 2-1/4"	D214	

**Backset Options**

Description	Specify Quick Code	Add or Deduct
2-3/4"	(standard)	No Charge
3-3/4"	B334	Add \$15.00 to lockset
5"	B500	Add \$24.00 to lockset

**Strike Options<sup>2</sup>** (to purchase strike separately, see catalog or parts manual for part no.)

Lip Length	ANSI Curved Lip - Specify Quick Code	Curved Lip Box - Specify Quick Code	Add or Deduct
1"	SA100	SC100	No Charge
1-1/8"	SA118	SC118	
1-1/4"	(standard)	SC114	
1-3/8"	SA138	SC138	
1-1/2"	SA112	SC112	
1-3/4"	SA134	SC134	Add \$16.00 per lockset
2"	SA200	SC200	
2-1/4"	SA214	SC214	
2-1/2"	SA212	SC212	
2-3/4"	SA234	SC234	
3"	SA300	SC300	

<sup>12</sup>If door thickness is standard or has been specified and no special door or frame condition exist, then only the first two characters of the optional strike Quick Code must be specified (e.g. "SC").  
The correct lip length will be determined by our order entry system based on the standard or specified door thickness.

**Miscellaneous Options**

Description	Specify Quick Code	Add or Deduct
Spanner head screws	M02	Add \$16.00 per lockset
Torx® head screws	M04	Add \$22.00 per lockset
Less cylinder and with tailpiece for Schlage® cylinder <sup>2</sup>	M06	No Charge
Lever to accept SFIC core <sup>2</sup>	M08	No Charge
Lever to accept Sargent® cylinder <sup>2</sup>	M09	No Charge
Security Lever (not available on non-keyed functions)	M111	No Charge
3/4" throw fire latch x 2-3/4" backset (not available for CL3120, 29, 40, and 93 functions) Finishes                      Matching Available                      Lock Finish 605                              605 606                      606, 611, 612, 613 626                              625, 626	M16	Add \$100.00 per lockset
ANSI wrought strike box	M17	No Charge
Knurling outside and inside	M20	Add \$132.00 per lockset
Knurling outside only	M21	Add \$66.00 per lockset
Knurling inside only	M22	Add \$66.00 per lockset
Abrasive coat outside and inside	M23	Add \$82.00 per lockset
Abrasive coat inside only	M24	Add \$41.00 per lockset
Abrasive coat outside only	M25	Add \$41.00 per lockset
Lead lining (roses)	M28	Add \$164.00 per lockset
Lever to accept Schlage® IC core <sup>2</sup>	M69	No Charge
STC 55 Acoustical Door Kit	M112	

## Notes:

2. Not available in CL3129 function.

**Standard Features**

**Handing**

Non-handed except FZD

**Door Thickness**

1-3/4" - 2"

**Backset**

2-3/4"

**Strike**

ANSI curved lip  
4-7/8" x 1-1/4" x 1-1/4" lip to center

**Cylinder**

Brass, 6-pin, L4 keyway, 0-bitted

**Keys**

Two nickel silver keys

**Case Quantity**

6

**Case Weight**

32 lbs

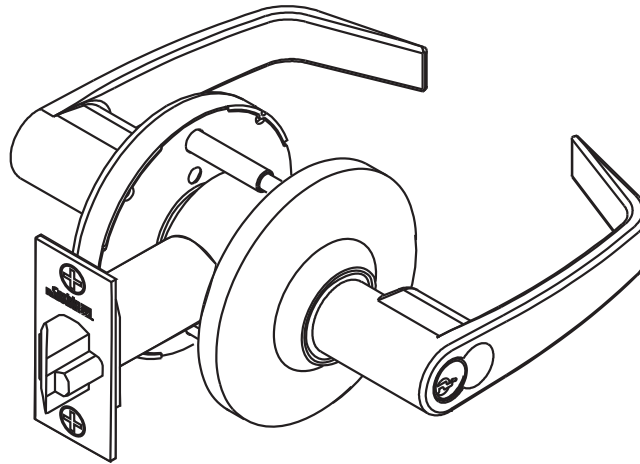

**Ordering Examples**

**Stock Order**

Quantity	Series/Function	Trim	Finish	Hand
100	CL3355	NZD	626	RHR

**Split Trim/Split Finish Order**

Quantity	Series/Function	Trim		Finish		Hand
		Outside	Inside	Outside	Inside	
12	CL3355	NZD	AZD	626	625	RHR

**Contract/Detailed Order**

Quantity	Keypad	Series/Function	Trim	Finish	Hand	Strike	Misc. Options	Cylinder and Keying
24	AA1	CL3355	NZD	626	RHR	SA112	M17	C6-VKC3

**Lever Designs: AZD, NZD, PZD, FZD**



**Lever:**  
Die cast zinc

**Rose:**  
Brass

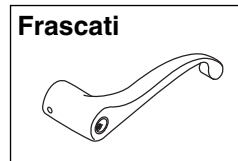
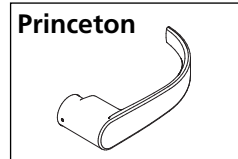
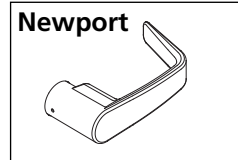

Function	Description	AZD, NZD, PZD, FZD	
		Finish: 613E, 626	Finish: 605, 606, 611, 612, 613, 613L, 618, 619, 625, 722
CL3310	Passage	\$458.00	\$474.00
CL3380	Passage x Blank Plate		
CL3390	Passage x Turnpiece	\$511.00	\$527.00
CL3320	Privacy		
CL3320H	Hospital Privacy	\$606.00	\$622.00
CL3320TO	Time Out Lock		
CL3340	Patio	\$511.00	\$527.00
CL3340NT	Exit Latch		
CL3350	Half Dummy	\$188.00	\$196.00
CL3370	Full Dummy	\$377.00	\$393.00
CL3351	Entrance		
CL3355	Classroom	\$606.00	\$622.00
CL3357	Storeroom		
CL3359	Storeroom or Public Restroom		
CL3361	Entrance	\$619.00	\$635.00
CL3375	Corridor/Dormitory		
CL3393	Service Station	\$673.00	\$689.00
CL3329	Hotel		
CL3381	Keyed x Blank Plate	\$606.00	\$622.00
CL3391	Keyed x Blank Plate		
CL3332	Institution		
CL3352	Classroom Intruder	\$697.00	\$713.00
CL3362	Communicating		
CL3372	Public Toilet		
CL33903*	Fail Safe	\$831.00	\$847.00
CL33905*	Fail Secure		



\*ElectroLynx®

As part of their promise to provide innovative, fast and effective, and higher security solutions to their customers, ASSA ABLOY Group companies offer ElectroLynx, a universal quick-connect system that simplifies the electrification of the door opening. ElectroLynx® is a registered trademark of ASSA ABLOY, Inc.

<b>Cylinder Options</b>		
Description	Specify Quick Code	Add or Deduct
Conventional 6-pin	(standard)	No Charge
Conventional 7-pin	7P	Add \$2.00 per cylinder
Less Cylinder <sup>4</sup>	LC	Deduct \$76.00 per cylinder
Access 3 Patented	AP	No Charge
Access 3 Security	AS	Add \$54.00 per cylinder
Access 3 High Security, UL 437	AHS	Add \$76.00 per cylinder
Access 3 IC Patented	ACP	Add \$71.00 per cylinder
Access 3 IC Security	ACS	Add \$120.00 per cylinder
Access 3 IC High Security, UL 437	ACHS	Add \$140.00 per cylinder
Pyramid Security Fixed Core <sup>3</sup>	PS	Add \$55.00 per cylinder
Pyramid Security IC <sup>3</sup>	PCS	Add \$124.00 per cylinder
Pyramid High Security Fixed Core <sup>3</sup>	PHS	Add \$82.00 per cylinder
Pyramid High Security IC <sup>3</sup>	PCHS	Add \$152.00 per cylinder
Pyramid IC with Temporary Construction Core	CTP	Add \$71.00 per cylinder
Pyramid IC with Temporary Disposable Core	CTPD	No Charge
Pyramid IC Less Core	CLP	No Charge
Security <sup>3</sup>	HS	Add \$105.00 per cylinder
Security IC <sup>3</sup>	CHS	Add \$176.00 per cylinder
IC 6-pin	C6	Add \$71.00 per cylinder
IC 6-pin with Temporary Construction Core (Red)	CT6R	Add \$71.00 per cylinder
IC 6-pin with Temporary Construction Core (Blue)	CT6B	Add \$71.00 per cylinder
IC 6-pin with Temporary Construction Core (Green)	CT6G	Add \$71.00 per cylinder
IC 6-pin with Temporary Disposable Core	CT6D	No Charge
Small Format Temporary Disposable Core	CTSD	No Charge
IC 6-pin Less Core <sup>3</sup>	CL6	No Charge
IC 7-pin	C7	Add \$73.00 per cylinder
IC 7-pin with Temporary Construction Core (Red)	CT7R	Add \$73.00 per cylinder
IC 7-pin with Temporary Construction Core (Blue)	CT7B	Add \$73.00 per cylinder
IC 7-pin with Temporary Construction Core (Green)	CT7G	Add \$73.00 per cylinder
IC 7-pin with Temporary Disposable Core	CT7D	No Charge
IC 7-pin Less Core <sup>3</sup>	CL7	
Lockset furnished in Schlage® C Keyway <sup>1, 3</sup>	C	
Lockset furnished in Sargent® LA Keyway <sup>2, 3</sup>	LA	

**Notes:**

1. Available 0-bitted & key random (KR) only.
2. Available 0-bitted only.
3. Not available in CL3329 function.
4. CL3329 function is not available less cylinder.

### Keying Options\*

Description	Specify Quick Code	Add or Deduct
0-Bitted with 2 blank keys	(standard)	No Charge
Keyed random	KR	
Master keyed (all cylinders except 8000, 8020, 8027 IC core)	Specify keyset	Add \$16.00 per cylinder
Master keyed Pyramid	Specify keyset	
Master keyed Security (including IC cylinder and core)	Specify keyset	
Master keyed (8000, 8020, 8027 IC core)	Specify keyset	No Charge
Master keyed to customer bittings or sample key	Specify keyset	Add \$16.00 per cylinder
Construction master keyed <sup>1,2</sup>	CMK	Add \$16.00 per cylinder
Visual key control (VKC)		
-No stamping	VKC0	\$4.50
-Keys only	VKC1	No Charge
-Cylinder and Keys <sup>3</sup>	VKC2	\$8.00
-Cylinders only <sup>3</sup>	VKC3	\$8.00
Concealed key control (CKC)		
-CKC cylinders with VKC keys	CKC2	\$8.00
-CKC cylinders only <sup>3</sup>	CKC3	\$8.00
More than 2 keys per lock	KY# (e.g., KY6)	See page 66 - Cut Keys Section

**Notes:**

1. CMK Construction master keying charge is in addition to master keying charge.
2. CMK Construction master keying is not available in Access 3, Pyramid or Security series.
3. VKC2, VKC3, CKC3 are not available in Access 3, Pyramid or Security series.

\*Double cylinder keying: unless otherwise specified, both cylinders of 32 and 82 functions will be keyed alike. The inside cylinder of 72 function will be keyed to the master key(s) only, while the outside cylinder will include the change key.

If different keying is required, specify outside cylinder first, then inside cylinder.

For key bows other than 10 and 90, specify 'KB' + bow number as Quick Code, e.g. KB12.

**Door Thickness Options**

Description	Specify Quick Code	Add or Deduct
1-3/4" - 2"	(standard)	No Charge
Over 2" up to 2-1/4"	D214	

**Backset Options**

Description	Specify Quick Code	Add or Deduct
2-3/4"	(standard)	No Charge
3-3/4"	B334	Add \$15.00 to lockset
5"	B500	Add \$24.00 to lockset

**Strike Options\*** (to purchase strike separately, see catalog or parts manual for part no.)

Lip Length	ANSI Curved Lip - Specify Quick Code	Curved Lip Box - Specify Quick Code	Add or Deduct
1"	SA100	SC100	No Charge
1-1/8"	SA118	SC118	
1-1/4"	(standard)	SC114	
1-3/8"	SA138	SC138	
1-1/2"	SA112	SC112	
1-3/4"	SA134	SC134	Add \$16.00 per lockset
2"	SA200	SC200	
2-1/4"	SA214	SC214	
2-1/2"	SA212	SC212	
2-3/4"	SA234	SC234	
3"	SA300	SC300	

Description	Specify Quick Code	Add or Deduct
Rabbeted front and strike	SR118	Add \$86.00 per lockset

\*If door thickness is standard or has been specified and no special door or frame condition exist, then only the first two characters of the optional strike Quick Code must be specified (e.g. "SC").  
The correct lip length will be determined by our order entry system based on the standard or specified door thickness.

**Miscellaneous Options**

Description	Specify Quick Code	Add or Deduct
Split designs and split finishes	Outside Trim x Inside Trim	Higher set price prevails
Spanner head screws	M02	Add \$16.00 per lockset
Torx® head screws	M04	Add \$22.00 per lockset
Less cylinder and with tailpiece for Schlage® cylinder <sup>2</sup>	M06	No Charge
Lever to accept SFIC core <sup>2</sup> (NZD, FZD and PZD designs only)	M08	No Charge
Lever to accept Sargent® cylinder <sup>2</sup>	M09	No Charge
1-1/8" latch front, rounded corners	M13	Add \$2.50 per latch
3/4" throw fire latch x 2-3/4" backset (not available for CL3320, 29, 40, and 93 functions)	M16	Add \$100.00 per lockset
Finishes                      Matching		
Available                    Lock Finish		
605                            605		
606                            606, 611, 612, 613		
626                            625, 626		
ANSI wrought strike box	M17	No Charge
Knurling outside and inside	M20	Add \$132.00 per lockset
Knurling outside only	M21	Add \$66.00 per lockset
Knurling inside only	M22	Add \$66.00 per lockset
Abrasive coat outside and inside	M23	Add \$82.00 per lockset
Abrasive coat inside only	M24	Add \$41.00 per lockset
Abrasive coat outside only	M25	Add \$41.00 per lockset
Lead lining (roses)	M28	Add \$164.00 per lockset
Lever to accept Schlage® IC core <sup>2</sup> (NZD and PZD designs only)	M69	No Charge
Request to Exit (REX) Switch (CL33900 only)	M92	\$186.00
CL33900 Series electrified options	12 AD	No Charge
12VAC/DC <sup>1</sup>	24 AD	
24VAC/DC		

**Notes:**

1. Voltage is universal for AC or DC current.
2. Not available in CL3329 function.



**Standard Features**

**Handing**

Non-handed

**Door Thickness**

1-3/4"

**Backset**

2-3/4"

**Strike**

ANSI curved lip  
4-7/8" x 1-1/4" x 1-1/4" lip to center

**Cylinder**

Brass, 6-pin, L4 keyway  
0-bitted

**Keys**

Two nickel silver keys

**Case Quantity**

6

**Case Weight**

26 lbs

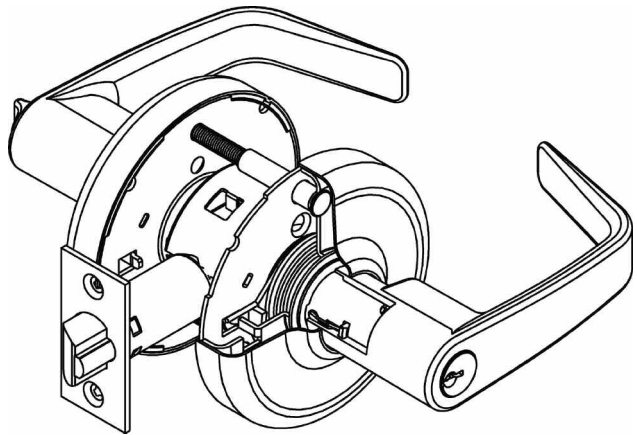

**Ordering Examples**

**Stock Order**

Quantity	Series/Function	Trim	Finish	Hand
100	CL3555	NZD	626	RH

**Split Trim/Split Finish Order**

Quantity	Series/Function	Trim		Finish		Hand
		Outside	Inside	Outside	Inside	
12	CL3555	NZD	AZD	626	625	RH

**Contract/Detailed Order**

Quantity	Keypad	Series/Function	Trim	Finish	Hand	Strike	Misc. Options	Cylinder and Keying
24	AA1	CL3555	NZD	626	RH	SA112	M17	C6-VKC3

**Lever Designs: AZD**



**Lever:**  
Die cast zinc

**Rose:**  
Brass



**AZD**

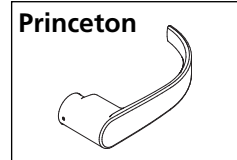
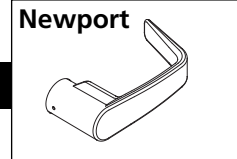

**Lever Designs: NZD**



**Lever:**  
Die cast zinc

**Rose:**  
Wrought Brass or Bronze



**NZD**

**Lever Designs: PZD**



**Lever:**  
Die cast zinc

**Rose:**  
Wrought Brass or Bronze



**PZD**

Function	Description		AZD, NZD, PZD	
			Finish: 613E, 626	Finish: 605, 606, 611, 612, 613, 613L, 618, 619, 625, 722
CL3510	Non-Keyed	Passage	\$422.00	\$438.00
CL3580		Passage x Blank Plate	\$466.00	\$482.00
CL3520		Privacy		
CL3550		Half Dummy		
CL3570		Full Dummy	\$377.00	\$393.00
CL3551	Single Cylinder	Entrance	\$530.00	\$546.00
CL3555		Classroom		
CL3557		Storeroom		
CL3561		Office or Privacy		
CL3581	Double Cylinder	Keyed x Blank Plate	\$606.00	\$622.00
CL3582		Store Door		

<b>Cylinder Options</b>		
<b>Description</b>	<b>Specify Quick Code</b>	<b>Add or Deduct</b>
Conventional 6-pin	(standard)	No Charge
Conventional 7-pin	7P	Add \$2.00 per cylinder
Less Cylinder	LC	Deduct \$76.00 per cylinder
Access 3 Patented	AP	No Charge
Access 3 Security	AS	Add \$54.00 per cylinder
Access 3 High Security, UL 437	AHS	Add \$76.00 per cylinder
Access 3 IC Patented	ACP	Add \$71.00 per cylinder
Access 3 IC Security	ACS	Add \$120.00 per cylinder
Access 3 IC High Security, UL 437	ACHS	Add \$140.00 per cylinder
Pyramid Security Fixed Core	PS	Add \$55.00 per cylinder
Pyramid Security IC	PCS	Add \$124.00 per cylinder
Pyramid High Security Fixed Core	PHS	Add \$82.00 per cylinder
Pyramid High Security IC	PCHS	Add \$152.00 per cylinder
Pyramid IC with Temporary Construction Core	CTP	Add \$71.00 per cylinder
Pyramid IC with Temporary Disposable Core	CTPD	No Charge
Pyramid IC Less Core	CLP	No Charge
Security	HS	Add \$105.00 per cylinder
Security IC	CHS	Add \$176.00 per cylinder
IC 6-pin	C6	Add \$71.00 per cylinder
IC 6-pin with Temporary Construction Core (Red)	CT6R	Add \$71.00 per cylinder
IC 6-pin with Temporary Construction Core (Blue)	CT6B	Add \$71.00 per cylinder
IC 6-pin with Temporary Construction Core (Green)	CT6G	Add \$71.00 per cylinder
IC 6-pin with Temporary Disposable Core	CT6D	No Charge
Small Format Temporary Disposable Core	CTSD	No Charge
IC 6-pin less core	CL6	No Charge
IC 7-pin	C7	Add \$73.00 per cylinder
IC 7-pin with Temporary Construction Core (Red)	CT7R	Add \$73.00 per cylinder
IC 7-pin with Temporary Construction Core (Blue)	CT7B	Add \$73.00 per cylinder
IC 7-pin with Temporary Construction Core (Green)	CT7G	Add \$73.00 per cylinder
IC 7-pin with Temporary Disposable Core	CT7D	No Charge
IC 7-pin Less Core	CL7	No Charge
Lockset furnished in Schlage® C Keyway <sup>1</sup>	C	
Lockset furnished in Sargent® LA Keyway <sup>2</sup>	LA	

**Notes:**

1. Available 0-bitted & key random (KR) only.
2. Available 0-bitted only.

**Keying Options\***

Description	Specify Quick Code	Add or Deduct
0-Bitted with 2 blank keys	(standard)	No Charge
Keyed random	KR	
Master keyed (all cylinders except 8000, 8020, 8027 IC core)	Specify keyset	Add \$16.00 per cylinder
Master keyed Pyramid	Specify keyset	
Master keyed Security (including IC cylinder and core)	Specify keyset	
Master keyed (8000, 8020, 8027 IC core)	Specify keyset	No Charge
Master keyed to customer bittings or sample key	Specify keyset	Add \$16.00 per cylinder
Construction master keyed <sup>1,2</sup>	CMK	Add \$16.00 per cylinder
Visual key control (VKC)		
-No stamping	VKC0	\$4.50
-Keys only	VKC1	No Charge
-Cylinder and Keys <sup>3</sup>	VKC2	\$8.00
-Cylinders only <sup>3</sup>	VKC3	\$8.00
Concealed key control (CKC)		
-CKC cylinders with VKC keys	CKC2	\$8.00
-CKC cylinders only <sup>3</sup>	CKC3	\$8.00
More than 2 keys per lock	KY# (e.g., KY6)	See page 66 - Cut Keys Section

## Notes:

1. CMK Construction master keying charge is in addition to master keying charge.
2. CMK Construction master keying is not available in Access 3, Pyramid or Security series.
3. VKC2, VKC3, CKC3 are not available in Access 3, Pyramid or Security series.

\*Double cylinder keying: unless otherwise specified, both cylinders of 82 functions will be keyed alike.

If different keying is required, specify outside cylinder first, then inside cylinder.

For key bows other than 10 and 90, specify "KB" + bow number as Quick Code, e.g. KB12.

**Door Thickness Options**

Description	Specify Quick Code	Add or Deduct
1-3/4"	(standard)	No Charge
1-3/8"	D138**1	

**Backset Options**

Description	Specify Quick Code	Add or Deduct
2-3/8"	B238 <sup>1</sup>	No Charge
2-3/4"	B234 (standard)	
3-3/4"	B334	Add \$15.00 to lockset
5"	B500	Add \$24.00 to lockset

**Strike Options\*** (to purchase strike separately, see catalog or parts manual for part no.)

Lip Length	ANSI Curved Lip Specify Quick Code	Curved Lip Box Specify Quick Code	Full Lip Specify Quick Code	Add or Deduct
1"	SA100	SC100		No Charge
1-1/8"	SA118	SC118	SF118	
1-1/4"	(standard)	SC114		
1-3/8"	SA138	SC138		
1-1/2"	SA112	SC112		Add \$16.00 per lockset
1-3/4"	SA134	SC134		
2"	SA200	SC200		
2-1/4"	SA214	SC214		
2-1/2"	SA212	SC212		
2-3/4"	SA234	SC234		
3"	SA300	SC300		

Description	Specify Quick Code	Add or Deduct
Rabbeted front and strike	SR118	Add \$86.00 per lockset

\*If door thickness is standard or has been specified and no special door or frame condition exist, then only the first two characters of the optional strike Quick Code must be specified (e.g. "SC").

The correct lip length will be determined by our order entry system based on the standard or specified door thickness.

\*\*If D138 is specified, 2-3/8" backset latch will be supplied unless B234 option is also specified.

1. M14 and B238 (2-3/8" backset) standard with D138 (1-3/8" door thickness) option.

**Miscellaneous Options**

Description	Specify Quick Code	Add or Deduct
Split designs and split finishes	Outside Trim x Inside Trim	Higher set price prevails
Spanner head screws	M02	Add \$16.00 per lockset
Torx® head screws	M04	Add \$22.00 per lockset
Less cylinder and with tailpiece for Schlage® cylinder	M06	No Charge
Lever to accept SFIC core (NZD & PZD design only)	M08	No Charge
Lever to accept Sargent® cylinder (NZD design only)	M09	No Charge
Lever to accept Schlage® Interchangeable core (NZD & PZD design only)	M69	No Charge
1-1/8" latch front, rounded corners	M13	Add \$2.50 per latch
1" latch front, square corners <sup>1</sup>	M14	Add \$6.00 per lockset
1" latch front, rounded corners	M15	Add \$2.50 per latch
ANSI wrought strike box	M17	No Charge
Knurling outside and inside	M20	Add \$132.00 per lockset
Knurling outside only	M21	Add \$66.00 per lockset
Knurling inside only	M22	Add \$66.00 per lockset
Abrasive coat outside and inside only	M23	Add \$82.00 per lockset
Abrasive coat inside only	M24	Add \$41.00 per lockset
Abrasive coat outside only	M25	Add \$41.00 per lockset
1-1/8" latch front, square corners (standard for 2-3/4" and 5" backsets)	M32	No Charge

## Note:

1. M14 and B238 (2-3/8" backset) standard with D138 (1-3/8" door thickness) option.

**Standard Features**

**Handing**

Non-handed

**Door Thickness**

1-3/8" - 1-7/8"  
Available in 2" - 2-1/4" upon request

**Backset**

2-3/4" standard

**Strike**

ANSI curved lip  
4-7/8" x 1-1/4" x 1-1/4" lip to center

**Cylinder**

Brass, 6-pin, L4 keyway  
0-bitted

**Keys**

Two nickel silver keys

**Case Quantity**

6

**Case Weight**

32 lbs

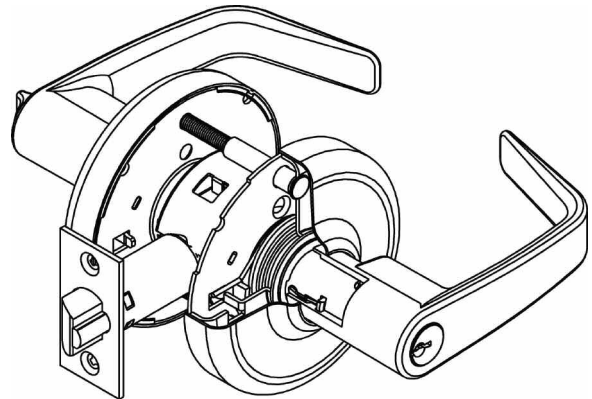

**Ordering Examples**

**Stock Order**

Quantity	Series/Function	Trim	Finish	Hand
100	CL3855	NZD	626	RHR

**Split Trim/Split Finish Order**

Quantity	Series/Function	Trim		Finish		Hand
		Outside	Inside	Outside	Inside	
12	CL3855	NZD	AZD	626	625	RHR

**Contract/Detailed Order**

Quantity	Keyset	Series/Function	Trim	Finish	Hand	Strike	Misc. Options	Cylinder and Keying
24	AA1	CL3855	NZD	626	RHR	SA112	M02	C6-VKC3

**Lever Designs: AZD, NZD, PZD**



**Armstrong**

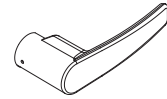

**Newport**

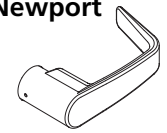

**Princeton**



**Lever:**

Die cast zinc

**Rose:**

Wrought Brass or Bronze



Function	Description	AZD, NZD, PZD	
		Finish: 613E, 626	Finish: 605, 606, 611, 612, 613, 613L, 618, 619, 625, 722
CL3810	Passage	\$200.00	\$216.00
CL3880	Passage x Blank Plate	\$220.00	\$236.00
CL3820	Privacy		
CL3850	Half Dummy	\$112.00	\$118.00
CL3870	Full Dummy	\$212.00	\$228.00
CL3851	Entrance	\$276.00	\$292.00
CL3855	Classroom		
CL3857	Storeroom		
CL3861	Office		



**Cylinder & Keying Options**

Description	Specify Quick Code	Add or Deduct
Conventional 6-pin	(standard)	No Charge
Conventional 7-Pin	7P	Add \$2.00 per cylinder
Less Cylinder	LC	Deduct \$76.00 per cylinder
Access 3 Patented	AP	No Charge
Access 3 Security	AS	Add \$54.00 per cylinder
Access 3 High Security, UL 437	AHS	Add \$76.00 per cylinder
Access 3 IC Patented	ACP	Add \$71.00 per cylinder
Access 3 IC Security	ACS	Add \$120.00 per cylinder
Access 3 IC High Security, UL 437	ACHS	Add \$140.00 per cylinder
Pyramid Security Fixed Core <sup>3</sup>	PS	Add \$55.00 per cylinder
Pyramid Security IC <sup>3</sup>	PCS	Add \$124.00 per cylinder
Pyramid High Security Fixed Core <sup>3</sup>	PHS	Add \$82.00 per cylinder
Pyramid High Security IC <sup>3</sup>	PCHS	Add \$152.00 per cylinder
Pyramid IC with Temporary Construction Core	CTP	Add \$71.00 per cylinder
Pyramid IC with Temporary Disposable Core	CTPD	No Charge
Pyramid IC Less Core	CLP	No Charge
Security	HS	Add \$105.00 per cylinder
Security IC	CHS	Add \$176.00 per cylinder
IC 6-pin	C6	Add \$71.00 per cylinder
IC 6-pin with Temporary Construction Core (Red)	CT6R	Add \$71.00 per cylinder
IC 6-pin with Temporary Construction Core (Blue)	CT6B	Add \$71.00 per cylinder
IC 6-pin with Temporary Construction Core (Green)	CT6G	Add \$71.00 per cylinder
IC 6-pin with Temporary Disposable Core	CT6D	No Charge
Small Format Temporary Disposable Core	CTSD	No Charge
IC 6-pin Less Core	CL6	No Charge
IC 7-Pin	C7	Add \$73.00 per cylinder
IC 7-Pin with Temporary Construction Core (Red)	CT7R	Add \$73.00 per cylinder
IC 7-Pin with Temporary Construction Core (Blue)	CT7B	Add \$73.00 per cylinder
IC 7-Pin with Temporary Construction Core (Green)	CT7G	Add \$73.00 per cylinder
IC 7-Pin with Temporary Disposable Core	CT7D	No Charge
IC 7-Pin Less Core	CL7	No Charge
Lockset furnished in Schlage® C Keyway <sup>1</sup>	C	No Charge
Lockset furnished in SARGENT® LA Keyway <sup>2</sup>	LA	No Charge
0-Bitted with 2 blank keys	(standard)	No Charge
Keyed random	KR	
Master keyed (all cylinders except 8000, 8020, 8027 IC core)	Specify keyset	Add \$16.00 per cylinder
Master keyed Pyramid	Specify keyset	
Master keyed Security (including IC cylinder and core)	Specify keyset	
Master keyed (8000, 8020, 8027 IC core)	Specify keyset	No Charge
Master keyed to customer bittings or sample key	Specify keyset	Add \$16.00 per cylinder
Construction master keyed <sup>3,4</sup>	CMK	Add \$16.00 per cylinder
Visual key control (VKC)		
-No stamping	VKC0	\$4.50
-Keys only	VKC1	No Charge
-Cylinder and Keys <sup>5</sup>	VKC2	\$8.00
-Cylinders only <sup>5</sup>	VKC3	\$8.00
Concealed key control (CKC)		
-CKC cylinders with VKC keys	CKC2	\$8.00
-CKC cylinders only <sup>3</sup>	CKC3	\$8.00
More than 2 keys per lock	KY# (e.g., KY6)	See page 66 - Cut Keys Section

**Notes:**

1. Available 0-bitted & key random (KR) only.
  2. Available 0-bitted only.
  3. CMK Construction master keying charge is in addition to master keying charge.
  4. CMK Construction master keying is not available in Pyramid or Security series.
  5. VKC2, VKC3, CKC3 are not available in Access 3, Pyramid or Security series.
- For key bows other than 10 and 90, specify "KB" + bow number as Quick Code, e.g. KB12. No extra charge.

**Door Thickness Options**

Description	Specify Quick Code	Add or Deduct
1-3/8" — 1-7/8"	(standard)	No Charge
2" — 2-1/4"	D214	Add \$5.00 per lockset

**Backset Options**

Description	Specify Quick Code	Add or Deduct
2-3/8"	B238 <sup>1</sup>	No Charge
2-3/4"	(standard)	
3-3/4"	B334	Add \$12.00 to lockset
5"	B500	Add \$14.00 to lockset

**Strike Options\*** (to purchase strike separately, see catalog or parts manual for part no.)

Lip Length	ANSI Curved Lip Specify Quick Code	Curved Lip Box Specify Quick Code	Full Lip Specify Quick Code	Full Lip Radius Corner Specify Quick Code	Add or Deduct
1"	SA100	SC100			No Charge
1-1/8"	SA118	SC118			
1-1/4"	(standard)	SC114	SF114	SFR114	
1-3/8"	SA138	SC138			
1-1/2"	SA112	SC112			Add \$16.00 per lockset
1-3/4"	SA134	SC134			
2"	SA200	SC200			
2-1/4"	SA214	SC214			
2-1/2"	SA212	SC212			
2-3/4"	SA234	SC234			
3"	SA300	SC300			

\*If door thickness is standard or has been specified and no special door or frame condition exist, then only the first two characters of the optional strike Quick Code must be specified (e.g. "SC"). The correct lip length will be determined by our order entry system based on the standard or specified door thickness.

**Miscellaneous Options**

Description	Specify Quick Code	Add or Deduct
Split designs and split finishes	Outside Trim x Inside Trim	Higher set price prevails
Spanner head screws	M02	Add \$16.00 per lockset
Torx® head screws	M04	Add \$22.00 per lockset
Less cylinder and with tailpiece for Schlage® cylinder	M06	No Charge
Lever to accept SFIC core (FZD, NZD & PZD design only)	M08	No Charge
Lever to accept Sargent® cylinder (NZD & PZD design only)	M09	No Charge
1-1/8" latch front, rounded corners	M13	Add \$2.50 per latch
1" latch front, square corners <sup>1</sup>	M14	Add \$6.00 per lockset
1" latch front, rounded corners	M15	Add \$2.50 per latch
ANSI wrought strike box	M17	No Charge
Knurling outside and inside	M20	Add \$132.00 per lockset
Knurling outside only	M21	Add \$66.00 per lockset
Knurling inside only	M22	Add \$66.00 per lockset
Abrasive coat outside and inside only	M23	Add \$82.00 per lockset
Abrasive coat inside only	M24	Add \$41.00 per lockset
Abrasive coat outside only	M25	Add \$41.00 per lockset
1-1/8" latch front, square corners (standard for 2-3/4" and 5" backsets)	M32	No Charge
Lever to accept Schlage® IC core (NZD & PZD designs only)	M69	No Charge

Note:

1. M14 and B238 (2-3/8" backset) standard with D138 (1-3/8" door thickness) option.

**Standard Features**

**Handing**

Field reversible

**Door Thickness**

1-3/4" - 2"

**Backset**

2-3/4"

**Strike**

ANSI curved lip 4-7/8" - 1-1/4" x  
1-1/4" lip to center

**Cylinder**

Brass, 6-pin, L4 keyway  
0-bitted

**Keys**

Two nickel silver keys

**Case Quantity**

10

**Case Weight**

32 lbs

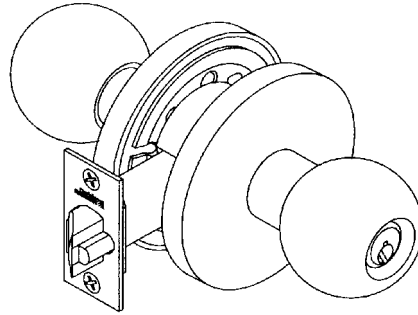

**Ordering Example**

**Stock Order**

Quantity	Series/Function	Trim	Finish	Hand
100	CK4355	GRD	630	RHR

**Contract/Detailed Order**

Quantity	Keyset	Series/Function	Trim	Finish	Hand	Strike	Misc. Options	Cylinder and Keying
24	AA1	CK4355	GRD	630	RHR	SA112	M02	VKC3

**Knob Designs: GRD**
**Knob:**

 Wrought  
Reinforced

**Rose:**

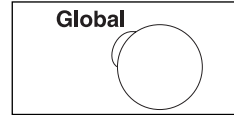
 Wrought  
Reinforced

Function	Description		GRD
			Finish: 605, 613E, 630
CK4310	Non-Keyed	Passage	\$549.00
CK4320		Privacy	\$616.00
CK4350		Half Dummy	\$236.00
CK4351	Single Cylinder	Entrance	\$681.00
CK4355		Classroom	
CK4357		Storeroom	
CK4332	Double Cylinder	Institution	\$742.00

**Cylinder Options**

Description	Specify Quick Code	Add or Deduct
Conventional 6-pin	(standard)	No Charge
Less (1) Cylinder	LC	Deduct \$76.00 per cylinder
Access 3 Patented	AP	No Charge
Access 3 Security	AS	Add \$54.00 per cylinder
Access 3 High Security, UL 437	AHS	Add \$76.00 per cylinder
Pyramid Security Fixed Core	PS	Add \$55.00 per cylinder
Pyramid High Security Fixed Core Security	PHS	Add \$82.00 per cylinder
	HS	Add \$105.00 per cylinder

**Keying Options\***

Description	Specify Quick Code	Add or Deduct
0-Bitted with 2 blank keys	(standard)	No Charge
Keyed random	KR	
Master keyed	Specify keyset	Add \$16.00 per cylinder
Master keyed Pyramid	Specify keyset	Add \$16.00 per cylinder
Master keyed Security	Specify keyset	Add \$16.00 per cylinder
Master keyed	Specify keyset	No Charge
Master keyed to customer bittings or sample key	Specify keyset	Add \$16.00 per cylinder
Construction master keyed <sup>1,2</sup>	CMK	Add \$16.00 per cylinder
Visual key control (VKC)		
-No stamping	VKC0	\$4.50
-Keys only	VKC1	No Charge
-Cylinder and Keys <sup>3</sup>	VKC2	\$8.00
-Cylinders only <sup>3</sup>	VKC3	\$8.00
Concealed key control (CKC)		
-CKC cylinders with VKC keys	CKC2	\$8.00
-CKC cylinders only <sup>3</sup>	CKC3	\$8.00
More than 2 keys per lock	KY# (e.g., KY6)	See page 66 - Cut Keys Section

**Notes:**

1. CMK Construction master keying charge is in addition to master keying charge.
2. CMK Construction master keying is not available in Pyramid or Security series.
3. VKC2, VKC3, CKC3 are not available in Access 3, Pyramid or Security series.

\*Double cylinder keying: unless otherwise specified, both cylinders of 32 functions will be keyed alike. If different keying is required, specify outside cylinder first, then inside cylinder. For key bows other than 10 and 90, specify "KB" + bow number as Quick Code, e.g. KB12. No extra charge.

**Strike Options\***

To purchase strike separately, see catalog or parts manual for part number.

Lip Length	ANSI Curved Lip - Specify Quick Code	Curved Lip Box - Specify Quick Code	Add or Deduct
1"	SA100	SC100	No Charge
1-1/8"	SA118	SC118	
1-1/4"	(standard)	SC114	
1-3/8"	SA138	SC138	
1-1/2"	SA112	SC112	
1-3/4"	SA134	SC134	Add \$16.00 per lockset
2"	SA200	SC200	
2-1/4"	SA214	SC214	
2-1/2"	SA212	SC212	
2-3/4"	SA234	SC234	
3"	SA300	SC300	

\*If door thickness is standard or has been specified and no special door or frame condition exist, then only the first two characters of the optional strike Quick code must be specified(e.g. "SC").  
The correct lip length will be determined by our order entry system based on the standard or specified door thickness.

**Backset Options**

Description	Specify Quick Code	Add or Deduct
2-3/4"	(standard)	No Charge

**Door Thickness Options**

Description	Specify Quick Code	Add or Deduct
1-3/4" - 2"	(standard)	No Charge

**Miscellaneous Options**

Description	Specify Quick Code	Add or Deduct
Spanner head screws	M02	Add \$16.00 per lockset
Torx® head screws	M04	Add \$22.00 per lockset
ANSI wrought strike box	M17	No Charge

**Standard Features**

**Handing**

Field reversible

**Door Thickness**

1-3/8" - 1-3/4"

**Backset**

2-3/4"

**Strike**

ANSI curved Lip 4-7/8" x 1-1/4"  
x 1-1/4" lip to center

**Cylinder**

Brass, 6-pin, L4 keyway,  
0-bitted

**Keys**

Two nickel silver keys

**Case Quantity**

20

**Case Weight**

40 lbs

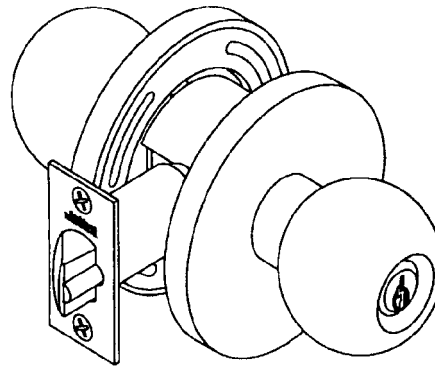

**Ordering Example**

**Stock Order**

Quantity	Series/Function	Trim	Finish	Hand
100	CK4451	GWC	630	RHR

**Split Trim/Split Finish Order** (Privacy function CK4430 only: inside finish 629 only)

Quantity	Series/Function	Finish	Finish		Hand
			Outside	Inside	
12	CK4430	GWC	605	629	RHR

**Contract/Detailed Order**

Quantity	Keyset	Series/Function	Trim	Finish	Hand	Strike	Misc. Options	Cylinder and Keying
24	AA1	CK4451	GWC	630	RHR	SA200	M17	VK1

**Knob Designs: GWC**
**Knob:**  
Wrought

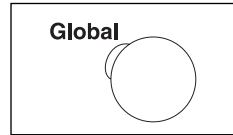
**Rose:**  
Wrought  
Reinforced

Function	Description	GWC		
		Finish: 630	Finish: 605, 612, 613, 629	
CK4410	Non-Keyed	Passage	\$174.00	\$190.00
CK4480		Communicating		
CK4430		Privacy	\$193.00	\$209.00
CK4440		Patio		
CK4450	Half Dummy	\$145.00	\$153.00	
CK4451	Single Cylinder	Entrance	\$251.00	\$267.00
CK4455		Classroom		
CK4457		Storeroom		
CK4429		Hotel		
CK4482	Double Cylinder	Storeroom	\$251.00	\$267.00

**Cylinder & Keying Options\***

Description	Specify Quick Code	Add or Deduct
Conventional 6-pin	(standard)	No Charge
Less (1) cylinder	LC	Deduct \$76.00 per cylinder
Less hotel cylinder	LC	Deduct \$80.00
0-Bitted with 2 blank keys	(standard)	No Charge
Keyed random	KR	No Charge
Master keyed*	specify keyset	Add \$16.00 per cylinder
Master keyed to customer bittings or sample key	specify keyset	Add \$16.00 per cylinder
Construction master keyed <sup>1</sup>	CMK	Add \$16.00 per cylinder
Visual key control (VKC)		
-No stamping	VKC0	\$4.50
-Keys only	VKC1	No Charge
Concealed key control (CKC)		
-CKC cylinders with VKC keys	CKC2	\$8.00
-CKC cylinders only	CKC3	\$8.00
More than 2 keys per lock	KY# (e.g., KY6)	See page 66 - Cut Keys Section

Notes:

1. CMK Construction master keying charge is in addition to master keying charge.

\*Both cylinders of double cylinder function locksets will be keyed alike, unless otherwise specified.

If different keying is required, specify outside cylinder first, then inside cylinder.

For key bows other than 10 and 90, specify "KB" + bow number as Quick Code, e.g. KB12. No extra charge.

**Backset Options**

Description	Specify Quick Code	Add or Deduct
2-3/8"	B238	No Charge
2-3/4"	(standard)	
3-3/4"	B334	Add \$12.00 to lockset
5"	B500	Add \$14.00 to lockset

**Strike Options\***

To purchase strike separately, see catalog or parts manual for part no.

**Strike Options\*** (to purchase strike separately, see catalog or parts manual for part no.)

Lip Length	ANSI Curved Lip Specify Quick Code	Curved Lip Box Specify Quick Code	Full Lip Specify Quick Code	Full Lip Radius Corner Specify Quick Code	Add or Deduct
1"	SA100	SC100			No Charge
1-1/8"	SA118	SC118			
1-1/4"	(standard)	SC114	SF114	SFR114	
1-3/8"	SA138	SC138			
1-1/2"	SA112	SC112			
1-3/4"	SA134	SC134			Add \$16.00 per lockset
2"	SA200	SC200			
2-1/4"	SA214	SC214			
2-1/2"	SA212	SC212			
2-3/4"	SA234	SC234			
3"	SA300	SC300			

\*If door thickness is standard or has been specified and no special door or frame condition exist, then only the first two characters of the optional strike Quick Code must be specified (e.g. "SC").

**Miscellaneous Options**

Description	Specify Quick Code	Add or Deduct
Split designs and split finishes	Outside Trim x Inside Trim	Higher set price prevails
NOTE: Split finish on inside must be 629 for CK4430 only.		
1" latch front, square corners (for 2-3/8" backset only)	M14	Add \$6.00 per lockset
ANSI wrought strike box	M17	No Charge
Abrasive coat outside and inside	M23	Add \$82.00 per lockset
Abrasive coat inside only	M24	Add \$41.00 per lockset
Abrasive coat outside only	M25	Add \$41.00 per lockset



**Standard Features**

**Handing**

Specify hand

**Door Thickness**

1-3/4" only

**Backset**

2-3/4" only

**Strike**

ANSI curved lip 4-7/8" x 1-1/4" x 1-1/4" lip to center

**Cylinder**

Brass, 6-pin, L4 keyway, 0-bitted

**Keys**

Two nickel silver keys

**Case Quantity**

6 leversets  
9 knobsets

**Case Quantity**

36

**Case Weight**

45 lbs

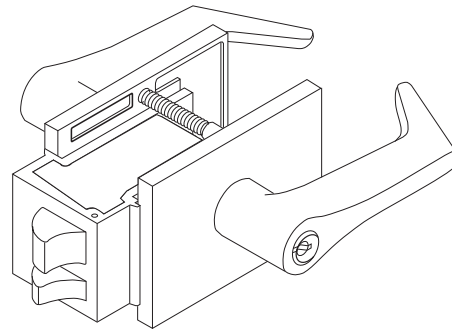

Now available with MicroShield® antimicrobial finish. Specify 626C finish (\$35.00 upcharge per lockset)

**Ordering Example**

**Stock Order**

Quantity	Series/Function	Trim	Finish	Hand
100	UT5251	ESE	626	RH

**Split Trim/Split Finish Order**

Quantity	Series/Function	Trim	Finish		Hand
			Outside	Inside	
12	UT5251	ESE	626	625	RHR

**Contract/Detailed Order**

Quantity	Keyset	Series/Function	Trim	Finish	Hand	Strike	Misc. Options	Cylinder and Keying
24	AA1	UT5251	ESE	626	RHR	SC200	M21	MR-VKC3

**Lever Designs: ESE**

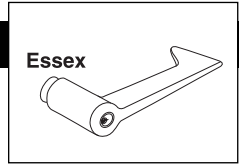

**Lever:**  
Forged

**Escutcheon:**  
Forged

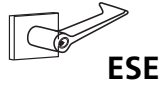

Function	Description		ESE
			Finish: 612, 613, 613E, 625, 626
UT5210	Non-keyed	Passage or Closet	\$1,141.00
UT5220		Privacy	\$1,223.00
UT5251	Single Cylinder	Entrance	\$1,309.00
UT5255		Classroom	
UT5257		Storeroom	
UT5282	Double Cylinder	Store Door	\$1,381.00

**Cylinder Options**

Description	Specify Quick Code	Add or Deduct
Conventional 6-pin	(standard)	No Charge
Less (1) Cylinder	LC	Deduct \$76.00 per cylinder
Access 3 Patented	AP	No Charge
Access 3 Security	AS	Add \$54.00 per cylinder
Access 3 High Security, UL 437	AHS	Add \$76.00 per cylinder
Access 3 IC Patented	ACP	Add \$71.00 per cylinder
Access 3 IC Security	ACS	Add \$120.00 per cylinder
Access 3 IC High Security, UL 437	ACHS	Add \$140.00 per cylinder
Pyramid Security Fixed Core	PS	Add \$55.00 per cylinder
Pyramid Security IC	PCS	Add \$124.00 per cylinder
Pyramid High Security Fixed Core	PHS	Add \$82.00 per cylinder
Pyramid High Security IC	PCHS	Add \$152.00 per cylinder
Pyramid IC with Temporary Construction Core	CTP	Add \$71.00 per cylinder
Pyramid IC with Temporary Disposable Core	CTPD	No Charge
Pyramid IC Less Core	CLP	No Charge
Security	HS	Add \$105.00 per cylinder
Security IC	CHS	Add \$176.00 per cylinder
IC 6-pin	C6	Add \$71.00 per cylinder
IC 6-pin with Temporary Construction Core (Red)	CT6R	Add \$71.00 per cylinder
IC 6-pin with Temporary Construction Core (Blue)	CT6B	Add \$71.00 per cylinder
IC 6-pin with Temporary Construction Core (Green)	CT6G	Add \$71.00 per cylinder
IC 6-pin with Temporary Disposable Core	CT6D	No Charge
IC 6-pin with Small Format Temporary Disposable Core	CTSD	No Charge
IC 6-pin Less Core	CL6	No Charge
IC 7-pin	C7	Add \$73.00 per cylinder
IC 7-pin with Temporary Construction Core (Red)	CT7R	Add \$73.00 per cylinder
IC 7-pin with Temporary Construction Core (Blue)	CT7B	Add \$73.00 per cylinder
IC 7-pin with Temporary Construction Core (Green)	CT7G	Add \$73.00 per cylinder
IC 7-pin with temporary Disposable Core	CT7D	No Charge
IC 7-pin Less Core	CL7	No Charge
Master Ring	MR	\$45.00

**Keying Options\***

Description	Specify Quick Code	Add or Deduct
0-Bitted with 2 blank keys	(standard)	No Charge
Keyed Random	KR	
Master keyed (all cylinders except 8000, 8020, 8027 IC core)	Specify keyset	Add \$16.00 per cylinder
Master keyed Pyramid	Specify keyset	
Master keyed Security (including IC cylinder and core)	Specify keyset	
Master keyed (8000, 8020, 8027 IC core)	Specify keyset	No Charge
Master keyed to customer bittings or sample key	Specify keyset	Add \$16.00 per cylinder
Construction master keyed <sup>1,2</sup>	CMK	Add \$16.00 per cylinder
Visual key control (VKC)		
-No stamping	VKC0	\$4.50
-Keys only	VKC1	No Charge
-Cylinder and Keys <sup>3</sup>	VKC2	\$8.00
-Cylinders only <sup>3</sup>	VKC3	
Concealed key control (CKC)		
-CKC cylinders with VKC keys	CKC2	\$8.00
-CKC cylinders only <sup>3</sup>	CKC3	
More than 2 keys per lock	KY# (e.g., KY6)	See page 66 - Cut Keys Section

**Notes:**

1. CMK Construction master keying charge is in addition to master keying charge.
2. CMK Construction master keying is not available in Pyramid or Security series.
3. VKC2, VKC3, CKC3 are not available in Access 3, Pyramid or Security series.

\*Double cylinder keying: unless otherwise specified, both cylinders of 32 and 82 functions will be keyed alike. The inside cylinder of 72 function will be keyed to the master key(s) only, while the outside cylinder will include the change key.

If different keying is required, specify outside cylinder first, then inside cylinder.

For key bows other than 10 and 90, specify "KB" + bow number as Quick Code, e.g. KB12. No extra charge.

**Strike Options\***

To purchase strike separately, see catalog for part no.

Lip Length	ANSI Curved Lip Specify Quick Code	T-Strike Curved Lip Box Specify Quick Code	Add or Deduct
1-1/4"	Standard	NA	No Charge
2"	N/A	SC200	Add \$16.00 per lockset
2-1/8"	N/A	SC218	
2-1/4"	N/A	SC214	
2-1/2"	N/A	SC212	
2-3/4"	N/A	SC234	
3"	N/A	SC300	

Lip Length	ANSI Straight Lip For Door Pair** Quick Code	For Door Pair** Quick Code	Add or Deduct
1-13/16"	SA136	SP136	No Charge

Lip length	ANSI Straight Lip For Extended Lip Escutcheon Quick Code	For Extended Lip Escutcheon Quick Code	Add or Deduct
15/16"	Standard when Extended Lip Option is Specified	SX156	No Charge

\*If door thickness is standard or has been specified and no special door or frame condition exist, then only the first two characters of the optional strike Quick code must be specified (e.g. "SC").

The correct lip length will be determined by our order entry system based on the standard or specified door thickness.

\*\* Lip is measured from back of strike.

**Miscellaneous Options**

Description	Specify Quick Code	Add or Deduct
Split designs and split finishes	Outside Trim x Inside Trim	Higher set price prevails
Delrin insert (knob filler cover)	M01	Add \$2.00 per lockset
Spanner head screws	M02	Add \$16.00 per lockset
Torx® head screws (on strike)	M04	Add \$22.00 per lockset
Lever to accept SFIC core (ESE only)	M08	Deduct \$20.00 per lockset
Knob to accept SFIC core, less core	M10	Add \$10.00 per knob. Less core, no cylinder deduct allowed.
Extended lip escutcheon (for single door reverse bevel; 630 finish to match 626 only)	M11	Add \$52.00 per lockset
Knurling outside and inside	M20	Add \$132.00 per lockset
Knurling outside only	M21	Add \$66.00 per lockset
Knurling Inside only	M22	
Abrasive coat outside and inside	M23	
Abrasive coat inside only	M24	Add \$41.00 per lockset
Abrasive coat outside only	M25	
Lead lining escutcheon	M28	
Unstaked lever retainer	M33	No Charge

[Empty rectangular box for notes]

**Standard Features**
**Case**

Extruded Brass

**Shackle**

1 1/32" (8.7mm) diameter hardened steel (PL5000 Series), brass (PL5100 Series) or stainless steel (PL5200 Series)

**Locking**

Ball-bearing locking heel and toe

**Cylinder**

 RFC model: 6-pin Fixed Core (2300)  
 IC model: 6-pin & Pyramid IC (8000 series)  
 L4 keyway standard

**Case Quantity**

36

**Case Weight**

27 lbs

**Ordering Example**
**Stock Order**

Quantity	Series/Function
10	PL5000R

**Access 3 Order**

Quantity	Series/Function	Misc. Options
8	PL5070	ACP M44

**Contract Order**

Quantity	Keyset	Series/Function	Shackle Length	Misc. Options
10	AA1	PL5080	258	M45

**Padlocks**

Hardened Steel Shackle	Brass Shackle	Description	List Price
PL5000R	PL5100R	Rekeyable Fixed Core (RFC)	\$97.00
PL5070*	PL5170*	Interchangeable core (IC), less core	\$103.00
PL5080	PL5180	IC 6-pin	\$174.00
PL5090	PL5190	IC security	\$279.00
PL5030	PL5130	Pyramid High Security (IC)	\$255.00
PL5037	PL5137	Pyramid Security (IC)	\$227.00

Stainless Steel Shackle	Description	List Price
PL5200R	Rekeyable Fixed Core (RFC)	\$102.00
PL5270*	Interchangeable core (IC), less core	\$108.00
PL5280	IC 6-pin	\$179.00
PL5290	IC security	\$284.00
PL5230	Pyramid High Security (IC)	\$260.00
PL5237	Pyramid Security (IC)	\$232.00

**Shackle Length Options with Padlocks**

Description	Specify Quick Code	Add or Deduct
7/8"	(standard)	No Charge
2-5/8"	258	Add \$5.00 to padlock

\* Access 3 is only available with Less Core.

**Cylinder & Keying Options\***

Description	Specify Quick Code	Add or Deduct
Access 3 IC Patented	ACP	Add \$71.00 per cylinder
Access 3 IC Security	ACS	Add \$116.00 per cylinder
Access 3 IC High Security, UL 437	ACHS	Add \$136.00 per cylinder
Keyed random (standard for Pyramid & IC security padlocks)	KR	No Charge
0-Bitted (not available for Pyramid & IC security padlocks)	(standard)	
Master Keyed RFC	specify keyset	Add \$16.00 per cylinder
Master Keyed IC security	specify keyset	
Master Keyed IC 6-pin & Pyramid IC	specify keyset	No Charge
Master Keyed to customer bittings or sample key	specify keyset	Add \$16.00 per cylinder
Construction Master Keyed (RFC & IC 6-pin padlocks only) <sup>1,2</sup>	CMK	Add \$16.00 per cylinder
Temporary construction core (IC 6-pin padlocks only) (Red)	CT6R	No Charge
Temporary Construction Core (IC 6-pin padlocks only) (Blue)	CT6B	No Charge
Temporary Construction Core (IC 6-pin padlocks only) (Green)	CT6G	No Charge
Visual key control (VKC)		
- No Stamping	VKC0	\$4.50
- Keys only	VKC1	No Charge
- Locks and Keys <sup>3</sup> (RFC & IC 6-pin padlocks only)	VKC2	\$8.00
- Locks only <sup>3</sup> (RFC & IC 6-pin padlocks only)	VKC3	
Concealed key control (CKC) (IC 6-pin & IC security padlocks only)		
- CKC cores with VKC keys <sup>4</sup>	CKC2	\$8.00
- CKC cores only <sup>3,4</sup>	CKC3	
More than 2 keys per lock	KY# (e.g., KY6)	See page 66 - Cut Keys Section
Rekeybale FC (RFC) Less Cylinder	LC	Deduct \$20.00

**Notes:**

1. CMK Construction master keying charge is in addition to master keying charge.
  2. CMK is not available in Pyramid or Security series.
  3. VKC2, VKC3, CKC3 are not available in Access 3, Pyramid or Security series.
  4. CKC2, CKC3 is not available in PL5000, PL5100, PL5070 or PL5170 padlock.
- \*For key bows other than 10 and 90, specify "KB" + bow number as Quick Code, e.g. KB12. No extra charge.

**Miscellaneous Options**

Description	Specify Quick Code	Add or Deduct
Chain and clevis attached	M44	Add \$4.00 per padlock
Custom die stamped case* (specify existing die number or lettering specifications for artwork)	M45**	Add \$5.5 per padlock

\*To create new die stamp, contact factory. Provide artwork with request for quotation.  
Die stamps remain the property of Corbin Russwin.

\*\*Only available on PL5200 Series stainless steel shackle padlocks.



**ANSI/BHMA 156.5  
Grade 2**

**Standard Features**

**Handing**

Non-handed

**Door Thickness**

1-3/8" - 2-1/4"

**Backset**

2-3/4" (standard)  
2-3/8" available

**Strike**

2-3/4" x 1-1/8"

**Cylinder**

Brass 6-pin,  
0-bitted, L4 keyway

**Keys**

Two nickel silver keys

**Case Quantity**

14

**Case Weight**

30 lbs

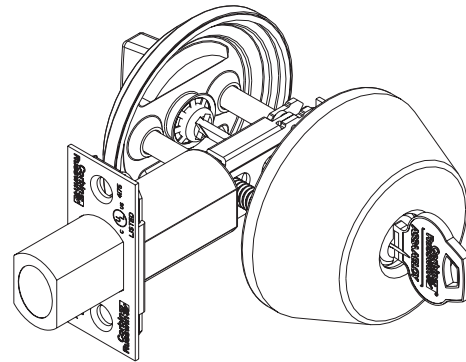

**Ordering Example**

**Stock Order**

Quantity	Series/Function	Finish
30	DL2213	626

**Contract Order**

Quantity	Keypad	Finish	Keypad	Optional Strike
30	DL2213	626	AA1	SS134

Function	Description	Finish: 613E, 626	Finish: 605, 606, 612, 613, 625
DL2213	Single Cylinder	\$103.00	\$107.00
DL2212	Double Cylinder	\$134.00	\$140.00
DL2217	Classroom	\$103.00	\$107.00
DL2211	Cylinder x Blank		
DL2260	Thumbturn x Blank	\$75.00	\$79.00

**Cylinder & Keying Options\***

Description	Specify Quick Code	Add or Deduct
Conventional 6-pin	(standard)	No Charge
Conventional 7-pin	7P	Add \$2.00 per cylinder
Less cylinder	LC	No Deduct
Interchangeable core (IC) 6-pin	C6	Add \$71.00 per cylinder
IC 6-pin less core	CL6	No Charge
SFIC 6-pin with Less Core	CLS6	No Charge
IC 6-pin with temporary construction core	CT6	Add \$71.00 per cylinder
IC 7-pin	C7	Add \$73.00 per cylinder
IC 7-pin less core	CL7	No Charge
SFIC 7-pin with Less Core	CLS7	No Charge
IC 7-pin with temporary construction core	CT7	Add \$73.00 per cylinder
Security	HS	Add \$105.00 per cylinder
Security IC	CHS	Add \$176.00 per cylinder
Access 3 Patented	AP	No Charge
Access 3 Security	AS	Add \$54.00 per cylinder
Access 3 High Security, UL 437	AHS	Add \$76.00 per cylinder
Access 3 IC Patented	ACP	Add \$71.00 per cylinder
Access 3 IC Security	ACS	Add \$120.00 per cylinder
Access 3 IC High Security, UL 437	ACHS	Add \$140.00 per cylinder
Pyramid High Security Fixed Core	PHS	Add \$82.00 per cylinder
Pyramid High Security IC	PCHS	Add \$152.00 per cylinder
Pyramid Security Fixed Core	PS	Add \$55.00 per cylinder
Pyramid Security IC	PCS	Add \$124.00 per cylinder
0-Bitted with two blank keys	(standard)	No Charge
Keyed Random	KR	No Charge
Construction Master Keyed (not available for Pyramid & Security cylinders) <sup>1</sup>	CMK	Add \$16.00 per cylinder
Visual key control (VKC)		
- Keys only	VKC1	No Charge
- Cylinders and Keys (not for Access 3, Pyramid, HS or CHS)	VKC2	\$8.00
- Cylinders only (not for Access 3, Pyramid, HS or CHS)	VKC3	
Concealed key control (CKC)		
- CKC cylinders with VKC keys	CKC2	\$8.00
- CKC cylinders only	CKC3	
More than 2 keys per lock	KY# (e.g., KY6)	See page 66 - Cut Keys Section

**Notes:**

1. CMK Construction master keying charge is in addition to master keying charge.

\*Both cylinders of double cylinder deadlocks are keyed alike, unless otherwise specified. If different keying is required, specify outside cylinder first, then inside cylinder.

For key bows other than 10 and 90, specify 'KB' + bow number as Quick Code, e.g. KB12.

Note: KB92 cannot be furnished with VKC or other markings.

**Strike Options**

To purchase strike separately, see catalog or parts manual for part no.

Lip Length	ANSI Straight Lip - Specify Quick Code	Add or Deduct
7/8"	SS078	No Charge
1-1/8"	SS118	
1-1/4"	SS114	
1-3/8"	SS138	
1-1/2"	SS112	
1-3/4"	SS134	
2"	SS200	Add \$16.00 per lockset
2-1/4"	SS214	
2-1/2"	SS212	
2-3/4"	SS234	
3"	SS300	

**Door Thickness Options**

Description	Specify Quick Code	Add or Deduct
1-3/8"	D138	No Charge
1-3/4"	(standard)	No Charge
2"	D200	No Charge
2-1/4"	D214	No Charge

**Miscellaneous Options**

Description	Specify Quick Code	Add or Deduct
1" (25mm) bolt front, square corners	M14	Add \$6.00 per lockset
ANSI wrought strike box	M17	
Plastic box for standard strike	(standard)	
2-3/8" (60mm) backset bolt	B238	

**Standard Features**

**Handing**

Non-handed, except DL3017 function

**Door Thickness**

1-3/4" - 2-1/4"

**Backset**

2-3/4" (standard)

**Strike**

Wrought brass or bronze  
2-3/4" x 1-1/8" with  
wrought box

**Cylinder**

Brass 6-pin,  
0-bitted, L4 keyway

**Keys**

Two nickel silver keys

**Weight**

2.5 lbs each

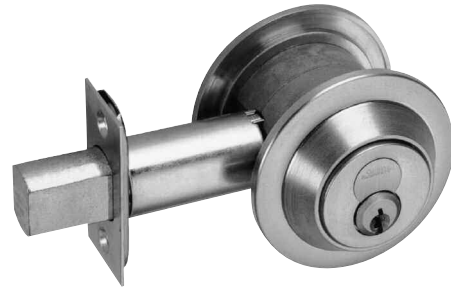

**Ordering Example**

**Stock Order**

Quantity	Series/Function	Finish
30	DL3013	626

**Contract Order**

Quantity	Keyset	Finish	Keyset	Optional Strike
30	DL3013	626	AA1	SD002

Function	Description	Finish: 605, 606, 612 613 613E, 618, 619, 625, 626, 722
DL3013	Single Cylinder	\$240.00
DL3012	Double Cylinder	\$323.00
DL3017	Classroom*	\$246.00
DL3011	Cylinder x Blank	\$240.00
DL3060	Thumbturn x Blank	

\*Thumbturn will not project deadbolt. Specify hand.

**Cylinder & Keying Options\***

Description	Specify Quick Code	Add or Deduct
Conventional 6-pin	(standard)	No Charge
Conventional 7-pin	7P	Add \$2.00 per cylinder
Less cylinder	LC	Deduct \$83.00 per cylinder
Access 3 Patented	AP	No Charge
Access 3 Security	AS	Add \$54.00 per cylinder
Access 3 High Security, UL 437	AHS	Add \$76.00 per cylinder
Access 3 IC Patented	ACP	Add \$71.00 per cylinder
Access 3 IC Security	ACS	Add \$120.00 per cylinder
Access 3 IC High Security, UL 437	ACHS	Add \$140.00 per cylinder
Pyramid Security fixed core	PS	Add \$55.00 per cylinder
Pyramid Security IC	PCS	Add \$124.00 per cylinder
Pyramid High Security fixed core	PHS	Add \$82.00 per cylinder
Pyramid High Security IC	PCHS	Add \$152.00 per cylinder
Pyramid IC with Temporary Construction Core	CTP	Add \$71.00 per cylinder
Security	HS	Add \$106.00 per cylinder
Security IC	CHS	Add \$176.00 per cylinder
IC 6-pin	C6	Add \$71.00 per cylinder
IC 6-pin with temporary construction core	CT6	
UL IC 6-Pin Housing Less Core	CL6AH	\$71.00
UL IC 6-Pin Housing with Disposable Core	CTAHD	
UL IC 6-Pin Housing with (Red/Blue/ Green) Temporary Construction Core	CT6AH(R/B/G)	\$154.00
IC 6-pin less core	CL6	
SFIC 6-pin with Less Core	CLS6	No Charge
SFIC 7-pin less core	CLS7	
IC 7-pin	C7	Add \$73.00 per cylinder
IC 7-pin Less Core	CL7	Add \$2.00 per cylinder
IC 7-pin with Temporary Construction Core	CT7 (R/B/G)	Add \$73.00 per cylinder
0-Bitted with 2 blank keys	(standard)	
Keyed random	KR	No Charge
Construction master keyed <sup>1,2</sup>	CMK	Add \$16.00 per cylinder
Visual key control (VKC)		
- Keys only	VKC1	No Charge
- Cylinders and Keys <sup>3</sup>	VKC2	
- Cylinders only <sup>3</sup>	VKC3	\$8.00
Concealed key control (CKC)		
- CKC cylinders with VKC keys	CKC2	
- CKC cylinders only <sup>3</sup>	CKC3	\$8.00
More than 2 keys per lock	KY# (e.g., KY6)	See page 66 - Cut Keys Section

**Notes:**

1. CMK Construction master keying charge is in addition to master keying charge.

2. CMK is not available in Pyramid or Security series.

3. VKC2, VKC3, CKC3 are not available in Access 3, Pyramid or Security series.

\*Both cylinders of double cylinder deadlocks are keyed alike, unless otherwise specified. If different keying is required, specify outside cylinder first, then inside cylinder.

For key bows other than 10 and 90, specify "KB" + bow number as Quick Code, e.g. KB12. No extra charge.

4. Refer to page 47 for example of CTP option pricing.

**Strike Options\***

To purchase strike separately, see catalog or parts manual for part no.

Lip Length	ANSI Straight Lip - Specify Quick Code	Add or Deduct
7/8"	SS078	No Charge
1-1/8"	SS118	
1-1/4"	SS114	
1-3/8"	SS138	
1-1/2"	SS112	
1-3/4"	SS134	Add \$16.00 per lockset
2"	SS200	
2-1/4"	SS214	
2-1/2"	SS212	
2-3/4"	SS234	
3"	SS300	

**Strike Options (No lip)**

	Specify Quick Code	Add or Deduct
2-3/4" x 1-1/8"	(standard)	No Charge
3-1/2" x 1-1/8"	SD001	

**Door Thickness Options**

Description	Specify Quick Code	Add or Deduct
1-3/8" (Not available in IC option)	D138	No Charge
1-3/4" - 2"	(standard)	
2-1/4"	D214	Add \$7.00 per deadlock

**Miscellaneous Options**

Description	Specify Quick Code	Add or Deduct
ANSI wrought box	M17	No Charge
Ergonomic Thumbturn	M34	Add \$14.00
Wrought box for standard strike	(standard)	No Charge
2-3/8" backset	B238	

**Standard Features**

**Handing**

Non-handed

**Door Thickness**

1-3/8" - 2-1/4"

**Backset**

2-3/4" (standard)  
2-3/8" available

**Strike**

2-3/4" x 1-1/8"

**Cylinder**

Brass 6-pin,  
0-bitted, L4 keyway

**Keys**

Two nickel silver keys

**Case Quantity**

14

**Case Weight**

30 lbs

**ANSI/BHMA 156.5**

**Grade 1**

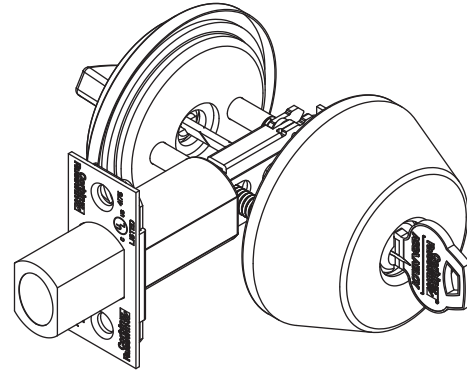

**Ordering Example**

**Stock Order**

Quantity	Series/Function	Finish
30	DL3213	626

**Contract Order**

Quantity	Keypad	Finish	Keypad	Optional Strike
30	DL3213	626	AA1	SS134

Function	Description	Finish: 613E, 626	Finish: 605, 606, 612, 613, 625
DL3213	Single Cylinder	\$185.00	\$192.00
DL3212	Double Cylinder	\$257.00	\$264.00
DL3217	Classroom	\$185.00	\$192.00
DL3211	Cylinder x Blank		
DL3260	Thumbturn x Blank	\$160.00	\$164.00

**Cylinder & Keying Options\***

Description	Specify Quick Code	Add or Deduct
Conventional 6-pin	(standard)	No Charge
Conventional 7-pin	7P	Add \$2.00 per cylinder
Less (1) cylinder	LC	Deduct \$76.00 per cylinder
IC 6-pin	C6	Add \$71.00 per cylinder
SFIC 6-pin with Less Core	CLS6	No Charge
IC 6-pin less core	CL6	No Charge
IC 6-pin with temporary construction core	CT6	Add \$71.00 per cylinder
IC 7-pin	C7	Add \$73.00 per cylinder
IC 7-pin with temporary construction core	CT7	Add \$73.00 per cylinder
SFIC 7-pin with Less Core	CLS7	No Charge
IC 7-pin less core	CL7	No Charge
Security	HS	Add \$105.00 per cylinder
Security IC	CHS	Add \$176.00 per cylinder
Access 3 Patented	AP	No Charge
Access 3 Security	AS	Add \$54.00 per cylinder
Access 3 High Security, UL 437	AHS	Add \$76.00 per cylinder
Access 3 IC Patented	ACP	Add \$71.00 per cylinder
Access 3 IC Security	ACS	Add \$120.00 per cylinder
Access 3 IC High Security, UL 437	ACHS	Add \$140.00 per cylinder
Pyramid High Security Fixed Core	PHS	Add \$82.00 per cylinder
Pyramid High Security IC	PCHS	Add \$152.00 per cylinder
Pyramid Security Fixed Core	PS	Add \$55.00 per cylinder
Pyramid Security IC	PCS	Add \$124.00 per cylinder
0-Bitted with 2 blank keys	(standard)	No Charge
Keyed Random	KR	No Charge
Construction Master Keyed (not available for Pyramid & Security cylinders) <sup>1</sup>	CMK	Add \$16.00 per cylinder
Visual key control (VKC)		
- Keys only	VKC1	No Charge
- Cylinders and Keys (not for Access 3, Pyramid, CHS)	VKC2	\$8.00
- Cylinders only (not for Access 3, Pyramid, CHS)	VKC3	
Concealed key control (CKC)		
- CKC cylinders with VKC keys	CKC2	\$8.00
- CKC cylinders only	CKC3	
More than 2 keys per lock	KY# (e.g., KY6)	See page 66 - Cut Keys Section

**Notes:**

1. CMK Construction master keying charge is in addition to master keying charge.

\*Both cylinders of double cylinder deadlocks are keyed alike, unless otherwise specified. If different keying is required, specify outside cylinder first, then inside cylinder.

For key bows other than 10 and 90, specify 'KB' + bow number as Quick Code, e.g. KB12.

NOTE: KB92 cannot be furnished with VKC or other markings.



**Strike Options**

To purchase strike separately, see catalog or parts manual for part no.

Lip Length	ANSI Straight Lip - Specify Quick Code	Add or Deduct
7/8 "	SS078	No Charge
1-1/8 "	SS118	
1-1/4 "	SS114	
1-3/8 "	SS138	
1-1/2 "	SS112	
1-3/4 "	SS134	Add \$16.00 per lockset
2 "	SS200	
2-1/4 "	SS214	
2-1/2 "	SS212	
2-3/4 "	SS234	
3 "	SS300	

**Door Thickness Options**

Description	Specify Quick Code	Add or Deduct
1-3/8 "	D138	No Charge
1-3/4 "	(standard)	
2 "	D200	
2-1/4 "	D214	

**Miscellaneous Options**

Description	Specify Quick Code	Add or Deduct
1 " (25mm) bolt front, square corners	M14	No Charge
ANSI wrought strike box	M17	
Plastic box for standard strike	(standard)	
2-3/8 " (60mm) backset bolt	B238	

**Standard Features**

**Handing**

Non-handed

**Door Thickness**

1-3/4"

**Backset**

2-3/4"

**Strike**

Wrought brass or bronze  
3-1/2" x 1-1/8"

**Cylinder**

6-pin, L4 keyway, 0-bitted

**Keys**

Two nickel silver keys

**Weight**

2.25 lbs each

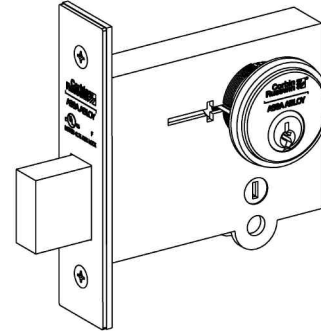

**Ordering Example**

**Stock Order**

Quantity	Series/Function	Finish
30	DL4113	626

**Contract Order**

Quantity	Keyset	Finish	Keyset	Optional Strike
30	DL4113	626	AA1	SS118

Function	Description	Finish: 613E, 626	Finish: 605, 606, 611, 612, 613, 618, 619, 625
DL4113	Single Cylinder	\$324.00	\$329.00
DL4112	Double Cylinder	\$359.00	\$364.00
DL4117	Classroom*	\$324.00	\$329.00
DL4111	Cylinder x Blank	\$276.00	\$281.00
DL4122	Double Cylinder x Thumbturn*	\$407.00	\$412.00
DL4160	Thumbturn x Blank	\$241.00	\$246.00

\*Thumbturn will not project deadbolt.

**Cylinder & Keying Options\***

Description	Specify Quick Code	Add or Deduct
Conventional 6-pin	(standard)	No Charge
Conventional 7-pin	7P	Add \$2.00 per cylinder
Less cylinder	LC	Deduct \$83.00 per cylinder
Access 3 Patented	AP	No Charge
Access 3 Security	AS	Add \$54.00 per cylinder
Access 3 High Security, UL 437	AHS	Add \$76.00 per cylinder
Access 3 IC Patented	ACP	Add \$71.00 per cylinder
Access 3 IC Security	ACS	Add \$120.00 per cylinder
Access 3 IC High Security, UL 437	ACHS	Add \$140.00 per cylinder
Pyramid High Security fixed core	PS	Add \$82.00 per cylinder
Pyramid High Security IC	PCS	Add \$152.00 per cylinder
Pyramid High Security fixed core	PHS	Add \$82.00 per cylinder
Pyramid High Security IC	PCHS	Add \$152.00 per cylinder
Security	HS	Add \$106.00 per cylinder
Security IC	CHS	Add \$176.00 per cylinder
IC 6-pin	C6	Add \$71.00 per cylinder
IC 6-pin less core	CL6	No Charge
SFIC 6-pin with Less Core <sup>2</sup>	CLS6	No Charge
IC 6-pin with SFIC disposable temporary core <sup>2</sup>	CT6SD	No Charge
IC 6-pin with temporary construction core	CT6	Add \$71.00 per cylinder
UL IC 6-Pin Housing Less Core	CL6AH	
UL IC 6-Pin Housing with Disposable Core	CTAHD	
UL IC 6-Pin Housing with (Red/Blue/Green) Temporary Construction Core	CT6AH(R/B/G)	\$154.00
IC 7-pin	C7	Add \$73.00 per cylinder
IC 7-pin less core	CL7	Add \$2.00 per cylinder
IC 7-pin with temporary construction core	CT7	Add \$73.00 per cylinder
SFIC 7-pin with Less Core <sup>2</sup>	CLS7	Add \$2.00 per cylinder
IC 7-pin with SFIC disposable temporary core <sup>2</sup>	CT7SD	Add \$2.00 per cylinder
0-Bitted with 2 blank keys	(standard)	No Charge
Keyed random	KR	
Construction master keyed <sup>1, 2</sup>	CMK	
Visual key control (VKC)		
- Keys only	VKC1	No Charge
- Cylinders and Keys <sup>3</sup>	VKC2	\$8.00
- Cylinders only <sup>3</sup>	VKC3	
Concealed key control (CKC)		
- CKC cylinders with VKC keys	CKC2	\$8.00
- CKC cylinders only <sup>3</sup>	CKC3	
More than 2 keys per lock	KY# (e.g., KY6)	See page 66 - Cut Keys Section

**Notes:**

1. CMK Construction master keying charge is in addition to master keying charge.
2. CMK is not available in Pyramid or Security series.
3. VKC2, VKC3, CKC3 are not available in Access 3, Pyramid or Security series.  
\*Both cylinders of double cylinder deadlocks are keyed alike, unless otherwise specified. If different keying is required, specify outside cylinder first, then inside cylinder.  
For key bows other than 10 and 90, specify "KB" + bow number as Quick Code, e.g. KB12.
4. Refer to page 47 for example of CTP option pricing.

**Strike Options**

To purchase strike separately, see catalog for part no.

Lip length	ANSI Straight Lip Specify Quick Code	Add or Deduct
7/8"	SS078	Add \$16.00 per lockset
1-1/8"	SS118	
1-1/4"	SS114	
1-3/8"	SS138	
1-1/2"	SS112	
1-3/4"	SS134	
2"	SS200	
2-1/4"	SS214	
2-1/2"	SS212	
2-3/4"	SS234	
3"	SS300	

**Door Thickness Options**

Description	Specify Quick Code	Add or Deduct
1-3/4" - 2"	(standard)	No Charge
2-1/4"	D214	
2-1/2"	D212	Add \$20.00 per dead lock
2-3/4"	D234	
3"	D300	
3-1/4"	D314	Add \$32.00 per deadlock
3-1/2"	D312	
3-5/8"	D358	
3-3/4"	D334	
3-7/8"	D378	
4"	D400	

**Miscellaneous Options**

Description	Specify Quick Code	Add or Deduct
Spanner head screws	M02	Add \$16.00 per lockset
Torx head screws	M04	Add \$23.00 per lockset
ANSI wrought box	M17	No Charge
Lead wrapped case	M29	Add \$262.00 per lockset
Ergonomic Thumbturn (specify door thickness)	M34	Add \$15.00 per TT
Box for standard strike	M40	No Charge

## FE5400S

### Multi-Point Exit Device Latching System

#### Standard Features

##### Handing

Device is non-handed  
Lever trim is handed

##### Bar Length

Standard: 36" (914mm) bar fits 30" - 36"  
(762mm-914mm) door

##### Door Height

7'0" (2134mm) standard

##### Door Thickness

1-3/4" (44mm) standard

##### Stile

Minimum width 4-1/2" (114mm).

##### Projection

3-1/4" (83mm) active, 2-3/4" (70mm) dogged.

##### Cylinders

Cylinder not included unless specified.

##### Warranty

Seven-year limited

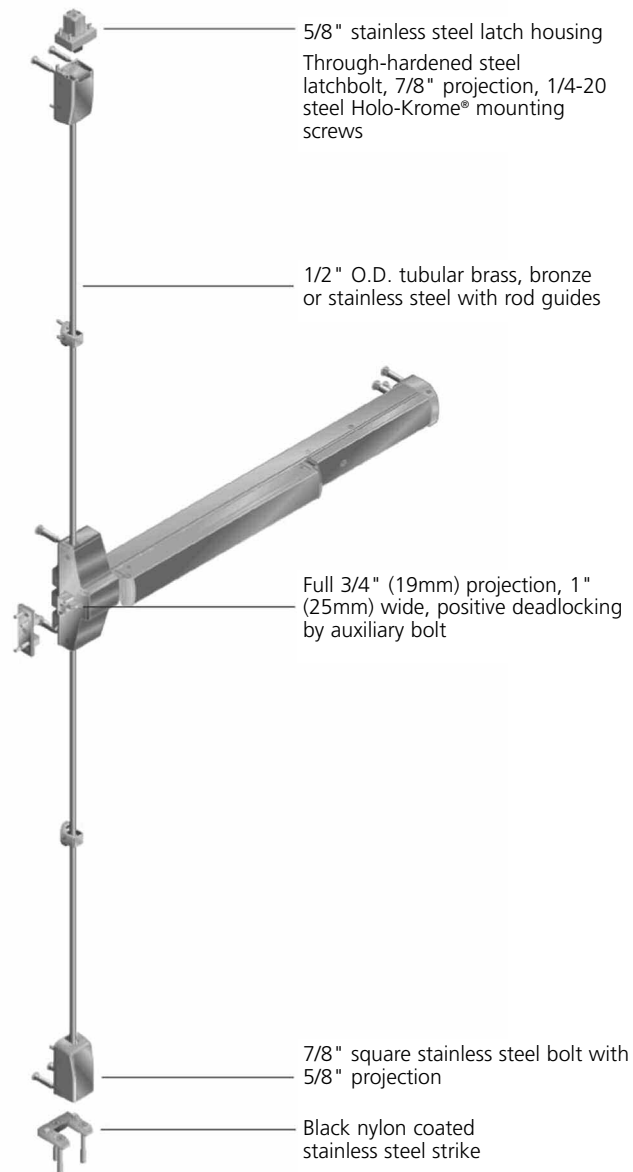

# FE5400S

## Multi-Point Exit Device Latching System



### Ordering Examples

#### Exit Device Only

Quantity	Series/Function	Finish	Hand	Misc. Options
65	FE5400S	626	RHR	M51

#### Trim Only

Quantity	Trim/Function	Finish	Hand	Door Thickness
24	N955	625	RHR	D214

#### Exit Device with Trim

Quantity	Exit Device	Trim/Function	Finish	Hand	Door Thickness	Door Width	Misc. Options
65	FE5400S	N955	605	LHR	D214	W048	M51

#### Contract/Detailed Order — Exit Device with Trim

Quantity	Keyset	Exit Device	Trim/Function	Finish	Hand	Door Height	Door Width	Misc. Options	Cylinder Option
36	AA1	FE5400S	C955	626	LHR	HO800	W048	M52	7P

### Pricing

#### 36" Device Only

Includes device, strike(s) and screw pack. No cylinder or trim.

FE5400S Series			
Function	Description	Finish: 613E, 630'	Finish: 605, 606, 611, 612, 613, 618, 619, 625, 626, 629, 722
FE5400S	Panic	\$3,355.00	\$3,435.00
FE5400SA	3 Hour Fire Rated	\$3,518.00	\$3,598.00

Caution: Be sure of your measurements. Exit devices are NOT returnable.

# FE5400S

## Multi-Point Exit Device Latching System

### FE5400S Series Heavy-Duty Trim

Cylinder is not included.

#### Escutcheon Trim Design: A9 Armstrong



**Lever:** Cast

**Escutcheon:** Forged

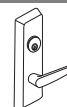

Function	Description	Finish: 613E, 630 <sup>1</sup>	Finish: 605, 606, 611, 612, 613, 618, 619, 625, 626, 629 <sup>2</sup> , 722
A910	Passage	\$633.00	\$659.00
A950	Dummy		
A955	Classroom <sup>3</sup>		
A959	Storeroom		

#### Escutcheon Trim Design: C9 Citation



**Lever:** Cast

**Escutcheon:** Forged

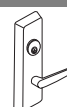

Function	Description	Finish: 613E, 630 <sup>1</sup>	Finish: 605, 606, 611, 612, 613, 618, 619, 625, 626, 629 <sup>2</sup> , 722
C910	Passage	\$633.00	\$659.00
C950	Dummy		
C955	Classroom <sup>3</sup>		
C959	Storeroom		

#### Escutcheon Trim Design: D9 Dirke



**Lever:** Cast

**Escutcheon:** Forged



Function	Description	Finish: 613E, 630 <sup>1</sup>	Finish: 605, 606, 611, 612, 613, 618, 619, 625, 626, 629 <sup>2</sup> , 722
D910	Passage	\$633.00	\$659.00
D950	Dummy		
D955	Classroom <sup>3</sup>		
D959	Storeroom		

#### Escutcheon Trim Design: E9 Essex



**Lever:** Cast

**Escutcheon:** Forged



Function	Description	Finish: 613E, 630 <sup>1</sup>	Finish: 605, 606, 611, 612, 613, 618, 619, 625, 626, 629 <sup>2</sup> , 722
E910	Passage	\$633.00	\$659.00
E950	Dummy		
E955	Classroom <sup>3</sup>		
E959	Storeroom		

**Notes:**

1. 619 finish provided to match 630 finish
2. 618 finish provided to match 629 finish.
3. Classroom function trim may be converted to storeroom function by a simple field adjustment. No additional parts required.

# FE5400S

## Multi-Point Exit Device Latching System



### FE5400S Series Heavy-Duty Trim

Cylinder is not included.

#### Escutcheon Trim Design: L9 Lustra



**Lever:** Cast

**Escutcheon:** Forged

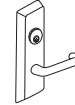

Function	Description	Finish: 613E, 630 <sup>1</sup>	Finish: 605, 606, 611, 612, 613, 618, 619, 625, 626, 629 <sup>2</sup> , 722
L910	Passage	\$633.00	\$659.00
L950	Dummy		
L955	Classroom <sup>3</sup>		
L959	Storeroom		

#### Escutcheon Trim Design: N9 Newport



**Lever:** Cast

**Escutcheon:** Forged

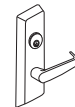

Function	Description	Finish: 613E, 630 <sup>1</sup>	Finish: 605, 606, 611, 612, 613, 618, 619, 625, 626, 629 <sup>2</sup> , 722
N910	Passage	\$633.00	\$659.00
N950	Dummy		
N955	Classroom <sup>3</sup>		
N959	Storeroom		

#### Escutcheon Trim Design: R9 Regis



**Lever:** Cast

**Escutcheon:** Forged

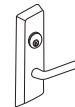

Function	Description	Finish: 613E, 630 <sup>1</sup>	Finish: 605, 606, 611, 612, 613, 618, 619, 625, 626, 629 <sup>2</sup> , 722
R910	Passage	\$633.00	\$659.00
R950	Dummy		
R955	Classroom <sup>3</sup>		
R959	Storeroom		

#### Escutcheon Trim Design: PR9 Princeton



**Lever:** Cast

**Escutcheon:** Forged



Function	Description	Finish: 613E, 630 <sup>1</sup>	Finish: 605, 606, 611, 612, 613, 618, 619, 625, 626, 629 <sup>2</sup> , 722
PR910	Passage	\$633.00	\$659.00
PR950	Dummy		
PR955	Classroom <sup>3</sup>		
PR959	Storeroom		

**Notes:**

1. 619 finish provided to match 630 finish. - Escutcheons only
2. 618 finish provided to match 629 finish. - Escutcheons only
3. Classroom function trim may be converted to storeroom function by a simple field adjustment. No additional parts required.



# FE5400S

## Multi-Point Exit Device Latching System



### FE5400S Series Heavy-Duty Trim

Cylinder is not included.

#### Escutcheon Trim Design: G9

**Lever:** Cast

**Escutcheon:** Forged



Function	Description	Finish: 613E, 630 <sup>1</sup>	Finish: 605, 606, 612, 613, 618, 619, 625, 626, 629 <sup>2</sup> , 722
G910	Passage	\$633.00	\$659.00
G950	Dummy		
G955	Classroom <sup>3</sup>		
G959	Storeroom		

Notes:

1. 619 finish provided to match 630 finish. - Escutcheons only
2. 618 finish provided to match 629 finish. - Escutcheons only
3. Classroom function trim may be converted to storeroom function by a simple field adjustment. No additional parts required.

#### Escutcheon Trim Design: TH900 Pull/Thumbpiece

**Grip:** Extruded

**Escutcheon:** Forged



Function	Description	Finish: 613E, 630 <sup>1</sup>	Finish: 605, 606, 611, 612, 613, 618, 619, 625, 626, 629 <sup>2</sup> , 722
TH910	Passage	\$457.00	\$483.00
TH950	Dummy (No thumbpiece)	\$427.00	\$453.00
TH955	Classroom <sup>3</sup>	\$457.00	\$483.00
TH959	Storeroom	\$427.00	\$453.00

#### Escutcheon Trim Design: P9 Pull



**Pull:** Extruded

**Escutcheon:** Forged

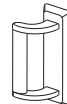

Function	Description	Finish: 613E, 630 <sup>1</sup>	Finish: 605, 606, 611, 612, 613, 618, 619, 625, 626, 629 <sup>2</sup> , 722
P950*	Dummy	\$392.00	\$418.00

\* Specify Hand. Field Reversible.

**FE5400S**  
Multi-Point Exit Device Latching System

**FE5400S Series Heavy-Duty Trim**

Cylinder is not included.

**Escutcheon Trim Design: FR9 Frascati\***



**Escutcheon:** Forged

\* Handed Lever. Handing cannot be changed in the field.

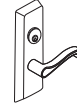

Function	Description	Finish: 613E, 626	Finish: 605, 606, 611, 612, 613, 618, 619, 625, 629, 722
FR910	Passage	\$633.00	\$659.00
FR950	Dummy		
FR955	Classroom <sup>3</sup>		
FR959	Storeroom		

**Escutcheon Trim Design: M9 Merlot**



**Escutcheon:** Forged

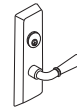

Function	Description	Finish: 613E, 626	Finish: 605, 606, 611, 612, 613, 618, 619, 625, 629, 722
M910	Passage	\$633.00	\$659.00
M950	Dummy		
M955	Classroom <sup>3</sup>		
M959	Storeroom		

**Escutcheon Trim Design: Z9 Zinfandel\***



**Escutcheon:** Forged

\* Handed Lever. Handing cannot be changed in the field.

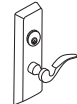

Function	Description	Finish: 613E, 626	Finish: 605, 606, 611, 612, 613, 618, 619, 625, 629, 722
Z910	Passage	\$633.00	\$659.00
Z950	Dummy		
Z955	Classroom <sup>3</sup>		
Z959	Storeroom		

Notes:

3. Classroom function trim may be converted to storeroom function by a simple field adjustment. No additional parts required.

**FE5400S**  
Multi-Point Exit Device Latching System

**FE5400S Series Heavy-Duty Trim**

Cylinder is not included.

**Escutcheon Trim Design: Muséo®**



GEORGIA



PABLO



JACKSON



SALVADOR



MARC



Parabolic Trim  
Specify: M60



Standard Trim

Function	Description	Finish: 613E, 630*	Finish: 605, 606, 611, 612, 613, 613L, 618, 619, 625, 626, 629*, 722
910	Passage	\$633.00	\$659.00
950	Dummy		
955	Classroom		
959	Storeroom		

\*629 and \*630 finish options are Not available for all Muséo levers. Please refer to page 20 for availability.

**Escutcheon Trim Design: Muséo®**



PIET



Function	Description	Finish: 629, 630
910	Passage	\$659.00
950	Dummy	
955	Classroom	
959	Storeroom	

**FE5400S**  
Multi-Point Exit Device Latching System

**FE5400S Series Electrically Controlled Trim**

Cylinder is not included.

**Escutcheon Trim Design: A9 Armstrong**



**Lever:** Cast    **Escutcheon:** Forged

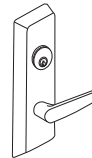

Function	Description	Finish: 613E, 630 <sup>1</sup>	Finish: 605, 606, 611, 612, 613, 618, 619, 625, 626, 629 <sup>2</sup> , 722
A9903*	Fail Safe	\$1,021.00	\$1,047.00
A9905*	Fail Secure		

**Escutcheon Trim Design: C9 Citation**



**Lever:** Cast    **Escutcheon:** Forged

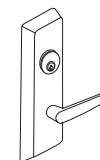

Function	Description	Finish: 613E, 630 <sup>1</sup>	Finish: 605, 606, 611, 612, 613, 618, 619, 625, 626, 629 <sup>2</sup> , 722
C9903*	Fail Safe	\$1,021.00	\$1,047.00
C9905*	Fail Secure		

**Escutcheon Trim Design: D9 Dirke\***



**Lever:** Cast    **Escutcheon:** Forged

\* Handed Lever. Handing cannot be changed in the field.

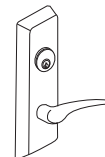

Function	Description	Finish: 613E, 630 <sup>1</sup>	Finish: 605, 606, 611, 612, 613, 618, 619, 625, 626, 629 <sup>2</sup> , 722
D9903*	Fail Safe	\$1,021.00	\$1,047.00
D9905*	Fail Secure		

**Escutcheon Trim Design: E9 Essex**



**Lever:** Cast    **Escutcheon:** Forged

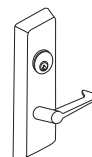

Function	Description	Finish: 613E, 630 <sup>1</sup>	Finish: 605, 606, 611, 612, 613, 618, 619, 625, 626, 629 <sup>2</sup> , 722
E9903*	Fail Safe	\$1,021.00	\$1,047.00
E9905*	Fail Secure		

Notes:  
1. 619 finish provided to match 630 finish. - Escutcheons only  
2. 618 finish provided to match 629 finish. - Escutcheons only



\*ElectroLynx®  
As part of their promise to provide innovative, fast and effective high security solutions to their customers, certain ASSA ABLOY Group brands offer **ElectroLynx®**, a universal quick-connect system that simplifies the electrification of the door opening.

**FE5400S Series Electrically Controlled Trim**

Cylinder is not included.

**Escutcheon Trim Design: L9 Lustra** 

**Lever:** Cast    **Escutcheon:** Forged

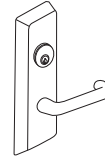

Function	Description	Finish: 613E, 630 <sup>1</sup>	Finish: 605, 606, 611, 612, 613, 618, 619, 625, 626, 629 <sup>2</sup> , 722
L9903*	Fail Safe	\$1,021.00	\$1,047.00
L9905*	Fail Secure		

**Escutcheon Trim Design: N9 Newport** 

**Lever:** Cast    **Escutcheon:** Forged

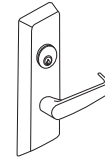

Function	Description	Finish: 613E, 630 <sup>1</sup>	Finish: 605, 606, 611, 612, 613, 618, 619, 625, 626, 629 <sup>2</sup> , 722
N9903*	Fail Safe	\$1,021.00	\$1,047.00
N9905*	Fail Secure		

**Escutcheon Trim Design: R9 Regis** 

**Lever:** Cast    **Escutcheon:** Forged

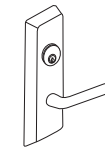

Function	Description	Finish: 613E, 630 <sup>1</sup>	Finish: 605, 606, 611, 612, 613, 618, 619, 625, 626, 629 <sup>2</sup> , 722
R9903*	Fail Safe	\$1,021.00	\$1,047.00
R9905*	Fail Secure		

**Escutcheon Trim Design: PR9 Princeton** 

**Lever:** Cast    **Escutcheon:** Forged

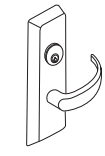

Function	Description	Finish: 613E, 630 <sup>1</sup>	Finish: 605, 606, 611, 612, 613, 618, 619, 625, 626, 629 <sup>2</sup> , 722
PR9903*	Fail Safe	\$1,021.00	\$1,047.00
PR9905*	Fail Secure		

Notes:  
 1. 619 finish provided to match 630 finish. - Escutcheons only  
 2. 618 finish provided to match 629 finish. - Escutcheons only



**\*ElectroLynx®**  
 As part of their promise to provide innovative, fast and effective high security solutions to their customers, certain ASSA ABLOY Group brands offer **ElectroLynx®**, a universal quick-connect system that simplifies the electrification of the door opening.

# FE5400S

## Multi-Point Exit Device Latching System

### FE5400S Series Electrically Controlled Trim

Cylinder is not included.

#### Escutcheon Trim Design: FR9 Frascati



**Lever:** Cast **Escutcheon:** Forged

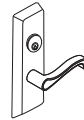

Function	Description	Finish: 613E, 626	Finish: 605, 606, 611, 612, 613, 618, 619, 625, 629, 722
FR9903*	Fail Safe	\$1,021.00	\$1,047.00
FR9905*	Fail Secure		

#### Escutcheon Trim Design: M9 Merlot



**Lever:** Cast **Escutcheon:** Forged

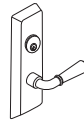

Function	Description	Finish: 613E, 626	Finish: 605, 606, 611, 612, 613, 618, 619, 625, 629, 722
M9903*	Fail Safe	\$1,021.00	\$1,047.00
M9905*	Fail Secure		

#### Escutcheon Trim Design: Z9 Zinfandel



**Lever:** Cast **Escutcheon:** Forged

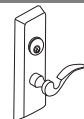

Function	Description	Finish: 613E, 626	Finish: 605, 606, 611, 612, 613, 618, 619, 625, 629, 722
Z9903*	Fail Safe	\$1,021.00	\$1,047.00
Z9905*	Fail Secure		



**\*ElectroLynx®**

As part of their promise to provide innovative, fast and effective high security solutions to their customers, certain ASSA ABLOY Group brands offer **ElectroLynx®**, a universal quick-connect system that simplifies the electrification of the door opening.

**FE5400S**  
Multi-Point Exit Device Latching System

**FE5400S Series Electrically Controlled Trim**

Cylinder is not included.

**Escutcheon Trim Design: Muséo®** 

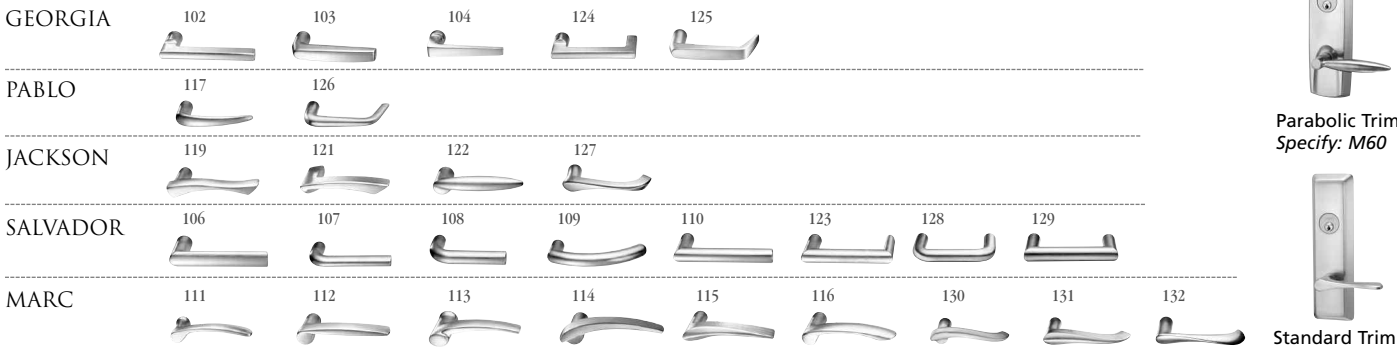

Function	Description	Finish: 613E, 630*	Finish: 605, 606, 611, 612, 613, 613L, 618, 619, 625, 626, 629*, 722
9903**	Fail Safe	\$1,021.00	\$1,047.00
9905**	Fail Secure		

\*629 and \*630 finish options are Not available for all Muséo levers. Please refer to page 20 for availability.

**Escutcheon Trim Design: Muséo®** 



Function	Description	Finish: 629, 630
9903**	Fail Safe	\$1,047.00
9905**	Fail Secure	



**\*\*ElectroLynx®**

As part of their promise to provide innovative, fast and effective high security solutions to their customers, certain ASSA ABLOY Group brands offer **ElectroLynx®**, a universal quick-connect system that simplifies the electrification of the door opening.

# FE5400S Electrically Controlled Trim

## Multi-Point Exit Device Latching System



### Electrified Options

Description	Specify Quick Code	Add or Deduct
Touchbar Monitoring or Signaling/Request to Exit (REX)	M92*	Add \$204.00
Outside Trim Monitoring or Signaling	M93*	Add \$204.00
SPDT Lock and Unlock security monitor switch (Electric Trim Only)	M98*	Add \$196.00
Trim gasket for exterior applications (Electric Trim Only)	M99	Add \$22.00

### Electrified Accessories

Part Number	Description	Specify	Price
709F649	Power Supply 1 Amp @ 12VDC Output	BPS-12-1	\$327.00
709F659	Power Supply 3 Amp @ 12VDC Output	BPS-12-3	\$664.00
709F609	Power Supply 2 Amp @ 24VDC Output	BPS-24-1	\$327.00
709F619	Power Supply 2 Amp @ 24VDC Output	BPS-24-2	\$664.00
709F629	Power Supply 4 Amp @ 24VDC Output	BPS-24-4	\$1,079.00
704F288	Concealed transfer (for over 120-degree swing door)	EPTL	\$124.00
709F689	(1) SPDT Maintained Switch (Includes LED)	MKA	\$118.00
709F709	(1) SPDT Momentary Switch (Includes LED)	MK	\$189.00
709F759	(1) SPDT Maintained (Alternating Action) Switch	PB3EA	\$111.00
709F729	DPDT Momentary Key Switch	2' MK2	\$217.00
704F719	Narrow Stile Momentary Key Switch	MKN	\$189.00
709F789	Sonalert 90db @ 2 ft. 12-24VDC Mounted on one gang stainless steel plate.	PZ1	\$93.00



#### \*ElectroLynx®

As part of their promise to provide innovative, fast and effective high security solutions to their customers, certain ASSA ABLOY Group brands offer *ElectroLynx*®, a universal quick-connect system that simplifies the electrification of the door opening.



# FE5400S Electrically Controlled Trim

## Multi-Point Exit Device Latching System



### Cylinder Options\*

Description	Specify Quick Code	Add or Deduct
Conventional 6-pin	6P**	Add \$83.00 per cylinder
Conventional 7-pin	7P	Add \$85.00 per cylinder
Access 3 Patented	AP	No Charge
Access 3 Security	AS	Add \$54.00 per cylinder
Access 3 High Security, UL 437	AHS	Add \$76.00 per cylinder
Access 3 IC Patented	ACP	Add \$71.00 per cylinder
Access 3 IC Security	ACS	Add \$120.00 per cylinder
Access 3 IC High Security, UL 437	ACHS	Add \$140.00 per cylinder
Pyramid Security fixed core	PS	Add \$138.00 per cylinder
Pyramid Security IC	PCS	Add \$197.00 per cylinder
Pyramid High Security fixed core	PHS	Add \$167.00 per cylinder
Pyramid High Security IC	PCHS	Add \$235.00 per cylinder
Pyramid IC with temporary construction core	CTP	Add \$154.00 per cylinder
Pyramid IC with temporary disposable core	CTPD	Add \$83.00 per cylinder
Pyramid IC less core	CLP	Add \$83.00 per cylinder
Security	HS	Add \$189.00 per cylinder
Security IC	CHS	Add \$259.00 per cylinder
Blockout function	BO	Add \$172.00 per cylinder
IC 6-pin	C6	Add \$154.00 per cylinder
IC 6-pin with temporary construction core (Red)	CT6R	Add \$154.00 per cylinder
IC 6-pin with temporary construction core (Blue)	CT6B	Add \$154.00 per cylinder
IC 6-pin with temporary construction core (Green)	CT6G	Add \$154.00 per cylinder
IC 6-pin with temporary disposable core	CT6D	Add \$83.00 per cylinder
IC 6-pin less core	CL6	Add \$83.00 per cylinder
SFIC 6-pin with Less Core	CLS6	Add \$83.00 per cylinder
IC 6-pin with SFIC disposable temporary core	CT6SD	Add \$83.00 per cylinder
IC 7-pin	C7	Add \$158.00 per cylinder
IC 7-pin with temporary construction core (Red)	CT7R	Add \$158.00 per cylinder
IC 7-pin with temporary construction core (Blue)	CT7B	Add \$158.00 per cylinder
IC 7-pin with temporary construction core (Green)	CT7G	Add \$158.00 per cylinder
IC 7-pin with temporary disposable core	CT7D	Add \$85.00 per cylinder
IC 7-pin less core	CL7	Add \$85.00 per cylinder
SFIC 7-pin with Less Core	CLS7	Add \$85.00 per cylinder
IC 7-pin with SFIC disposable temporary core	CT7SD	Add \$85.00 per cylinder

\*Optional dogging cylinder will be furnished with the same mechanism and keyed alike with the trim cylinder, unless otherwise specified. If different keying or cylinder type is required, specify outside (trim) first, then inside (dogging) cylinder.

\*\*6P cylinder option is supplied in 6-pin, L4 keyway, 0-bitted with two nickel silver keys.

### Keying Accessories\*

Description	Specify Quick Code	Add or Deduct
0-Bitted with 2 blank keys	(standard)	No Charge
Keyed random	KR	No Charge
Master keyed (all cylinders except 8000, 8020, 8027 IC)	specify keyset	Add \$16.00 per cylinder
Master keyed Pyramid	specify keyset	Add \$16.00 per cylinder
Master keyed Security (including IC cylinder and core)	specify keyset	Add \$16.00 per cylinder
Master keyed (8000, 8020, 8027 IC core)	specify keyset	No Charge
Master keyed to customer bittings or sample key	specify keyset	Add \$16.00 per cylinder
Construction master keyed <sup>1,2</sup>	CMK	Add \$16.00 per cylinder
Visual key control (VKC)		
- No Stamping	VKC0	\$4.50
- Keys only	VKC1	No Charge
- Cylinders and Keys <sup>3</sup>	VKC2	\$8.00
- Cylinders only <sup>3</sup>	VKC3	\$8.00
Concealed key control (CKC)		
- CKC cylinders with VKC keys	CKC2	\$8.00
- CKC cylinders only <sup>3</sup>	CKC3	\$8.00
More than 2 keys per lock	KY# (e.g., KY6)	See page 66 - Cut Keys Section

\*For key bows other than 10 and 90, specify "KB" + bow number as Quick Code, e.g. KB12.

Notes:

1. CMK Construction master keying charge is in addition to master keying charge.

2. CMK Construction master keying is not available in Pyramid or Security series.

3. VKC2, VKC3, CKC3 are not available in Pyramid or Security series.

# FE5400S Electrically Controlled Trim

## Multi-Point Exit Device Latching System



### Door Height Options

Door Height	Specify Quick Code	Add or Deduct
7'0"	(standard)	No Charge
7'2"	H0702	No Charge
7'6"	H0706	No Charge
8'0"	H0800	No Charge

### Door Width Options

Door Width	Specify Quick Code	Add or Deduct
32"	W032	No Charge
36"	(standard)	No Charge
42"	W042	No Charge
48"	W048	Add \$35.00 per device

### Door Thickness Options

Door Thickness	Specify Quick Code	Add or Deduct
1-3/4"	(standard)	No Charge
2"	D200	No Charge
2-1/4"	D214	No Charge

### Miscellaneous Options

Description	Specify	Add or Deduct
Knurling outside and inside (Embossed Touchbar - device side)	M20	Add \$139.00 per device
Knurling outside only (trim side)	M21	Add \$65.00 per device
Knurling inside only (Embossed Touchbar - device side)	M22	Add \$74.00 per device
Abrasive coat outside and inside (trim and device)	M23	Add \$88.00 per device
Abrasive coat inside only (device side)	M24	Add \$46.00 per device
Abrasive coat outside only (trim side)	M25	Add \$42.00 per device
PathLite™ Photoluminescent Touchbar cover	M49	Add \$348.00 per device
Less dogging	M51	No Charge
Cylinder dogging (less cylinder)	M52	Add \$78.00 per device
Mullion stabilizer	M57	Add \$62.00 per mullion
Parabolic Design Exit Trim	M60	Add \$78.00 per device
MicroShield® Antimicrobial finish coating	626C	Add \$62.00 (Exit Devices & Trims (ordered separately))
		Add \$76.00 (Exit Devices & Outside Trims (ordered together))
MicroShield® Antimicrobial finish coating	630C	Add \$62.00 (Exit Devices & Trims (ordered separately))
		Add \$76.00 (Exit Devices & Outside Trims (ordered together))

# FE5400S

## Multi-Point Exit Device Latching System



### Removable Mullions

Door Height	Description	Specify	Price
Up to 7'0"	Steel Mullion - 3 Hour Fire Rated, Windstorm Certified	FE707A <sup>4</sup>	\$1,101.00
Up to 8'0"	Steel Mullion - 3 Hour Fire Rated, Windstorm Certified	FE708A <sup>4</sup>	\$1,111.00

Note:

- 4. For use with UL listed door assemblies that comply to FEMA 361 and ICC 500.  
For the latest listings on compliant door assemblies visit our website at [corbinrusswin.com](http://corbinrusswin.com)

### Options

Description	Specify Quick Code	Add or Deduct
Door frame filler block for double rabbetted frames	M95	Add \$42.00 per mullion
Door frame angle bracket for aluminum frames	M96	Add \$42.00 per mullion

FE5400S

Notes



## FE6600 Series

### FE66600 Series Multi-Point Locks

<b>Door</b>	1-3/4" thick door only; fully integrated – FE66600 is part of a complete ASSA ABLOY windstorm solution utilizing CECO StormPro® 361 and CURRIES StormPro® 361 doors and frames and McKINNEY® StormPro® hinges
<b>Mounting</b>	Supplied fasteners are for metal doors with throughbolts for trim
<b>Hand</b>	Handed; specify RHR, LHR, RH or LH
<b>Lockbody</b>	Unique mortise lockbody assembly used specifically for FEMA applications
<b>Top Bolt</b>	Adjustable stainless steel 3/4" square bolt with 11/16" engagement; 5/16" steel reinforcement plate
<b>Bottom Bolt</b>	Adjustable stainless steel 3/4" square bolt with 5/8" engagement; 1/4" steel reinforcement plate
<b>Center Bolts</b>	Latchbolt is stainless steel with 3/4" projection. One piece, anti-friction reversible catch. Deadbolt is one piece hardened stainless steel with 1" projection
<b>Lock Front</b>	1/8" steel mortise front reinforced with 13/64" thick lock edge stiffener Center Bolt Strike 1/4" thick stainless steel
<b>Backset</b>	2-3/4" standard
<b>Door Thickness</b>	1-3/4" standard
<b>Door Height</b>	7'0" - 8'0"
<b>Maximum Opening</b>	Single door 4'0" x 8'0" and double doors 8'0" x 8'0"
<b>UL Fire Listed</b>	UL 3-hour fire rating
<b>Trim</b>	Multiple sectional and escutcheon mortise trim with Standard or Muséo levers
<b>Functions</b>	<ul style="list-style-type: none"> <li>- Passage</li> <li>- Classroom</li> <li>- Storeroom</li> <li>- Dormitory/Exit</li> <li>- Privacy</li> </ul>
<b>Cylinder</b>	Multiple mortise cylinders

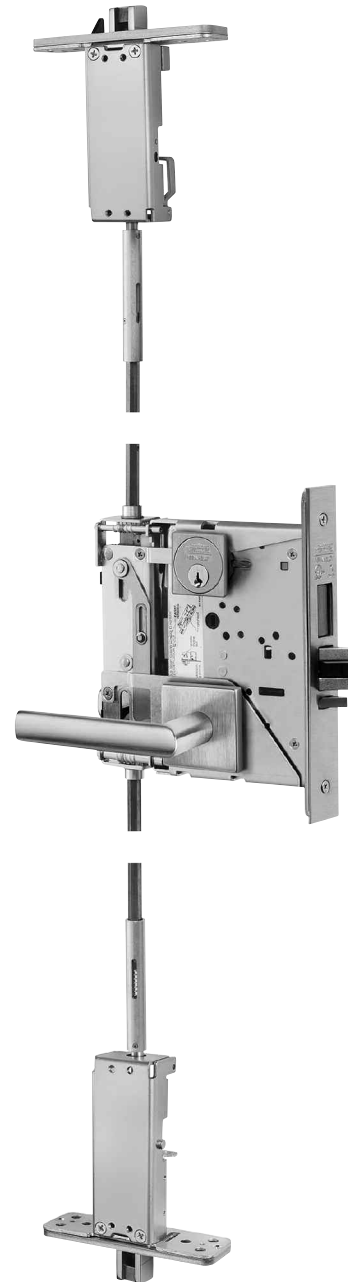

## How to Order

### Ordering Example

Quantity	Series/ Function	Trim	Finish	Hand
100	FE6618	ASM	626	RHR

# FE6600 Series Multi-Point Locks

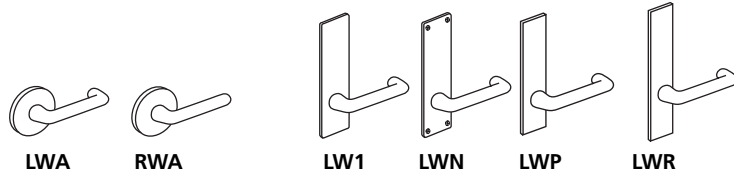

LWA RWA  
Lever: Wrought  
Rose: Wrought

LW1 LWN LWP LWR  
Lever: Wrought  
Escutcheon: Wrought

Lever: Wrought  
Escutcheon: Solid Stainless Steel  
or Forged Brass

Description/Function	Levers: LW, RW Roses: A, L		Levers: LW, RW Escutcheons: M, N, LW1		Levers: LW, RW Escutcheons: RE1/RE2, RE3/RE4	
	613E, 626	605, 606, 611, 612, 613, 618, 619, 625, 629, 630, 722	613E, 626	605, 606, 611, 612, 613, 618, 619, 625, 629, 630, 722	613E, 626	605, 606, 611, 612, 613, 618, 619, 625, 629, 630, 722
FE6618 - classroom FE6609 - passage or closet FE6680 - passage lever x blank plate FE6624 - storeroom door FE6665 - dormitory FE6620 - privacy FE6630 - privacy bath/bedroom	\$3,431.00	\$3,455.00	\$3,451.00	\$3,475.00	\$3,505.00	\$3,529.00

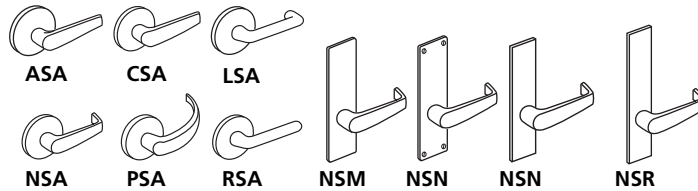

ASA CSA LSA  
NSA PSA RSA  
Lever: Cast  
Rose: Wrought

NSM NSN NSN NSR  
Lever: Cast  
Escutcheon: Wrought

Lever: Cast  
Escutcheon: Solid Stainless Steel  
or Forged Brass

Description/Function	Levers: AS, CS, ES, LS, NS, PS, RS Roses: A, L		Levers: AS, CS, ES, LS, NS, PS, RS Escutcheons: M, N, LW1		Levers: AS, CS, ES, LS, NS, PS, RS Escutcheons: RE1/RE2, RE3/RE4	
	613E, 626	605, 606, 611, 612, 613, 618, 619, 625, 629, 630, 722	613E, 626	605, 606, 611, 612, 613, 618, 619, 625, 629, 630, 722	613E, 626	605, 606, 611, 612, 613, 618, 619, 625, 629, 630, 722
FE6618 - classroom FE6609 - passage or closet FE6680 - passage lever x blank plate FE6624 - storeroom door FE6665 - dormitory FE6620 - privacy FE6630 - privacy bath/bedroom	\$3,431.00	\$3,455.00	\$3,451.00	\$3,475.00	\$3,505.00	\$3,529.00

# FE6600 Series Multi-Point Locks

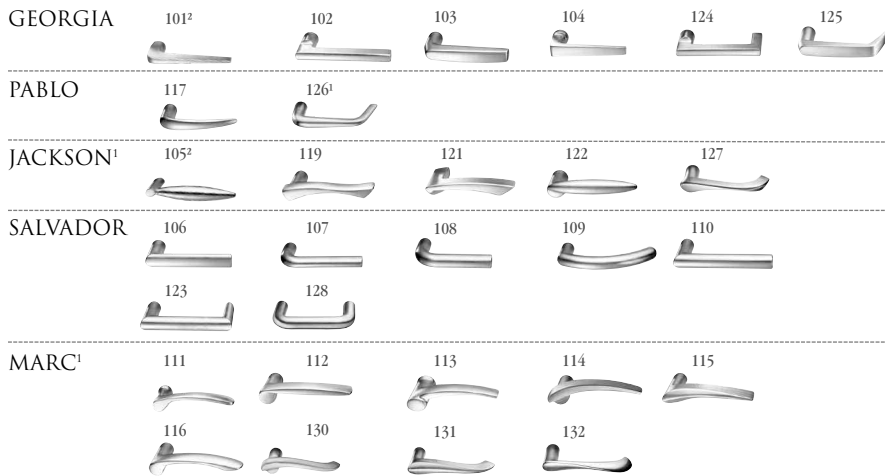

## ROSES

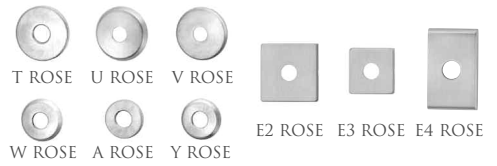

## ESCUTCHEONS



## THUMBTURNS³



1. Handed: specify hand when ordering
2. Contact factory for current lead time
3. Specify thumbturn as quick code. Thumbturn backplate will match shape of rose chosen (i.e. round or square). Not available with escutcheons.

\*629 and \*630 finish options are Not available for all Muséo levers. Please refer to page 20 for availability.

613E Dark Oxidized Satin Bronze - Equivalent  
626 Satin Chromium Plated

605 Bright Brass, Clear Coated  
606 Satin Brass, Clear Coated  
611 Bright Bronze, Clear Coated  
612 Satin Bronze, Clear Coated  
613 Dark Oxidized Satin Bronze, Oil Rubbed  
613L Dark Oxidized Satin Bronze, Clear Coated  
618 Bright Nickel Plated  
619 Satin Nickel Plated  
625 Bright Chromium Plated  
629\* Bright Stainless Steel  
630\* Satin Stainless Steel  
722 Black Oxidized Bronze, Oil Rubbed

### Function

Lever with Escutcheons: L, CE, RE1		
FE6618 - classroom		
FE6609 - passage or closet		
FE6680 - passage lever x blank plate		
FE6624 - storeroom door	\$3,471.00	\$3,495.00
FE6665 - dormitory		
FE6620 - privacy		
FE6630 - privacy bath/bedroom		
Lever with Roses: A, T, U, V, W, Y, E2, E3, E4		
FE6618 - classroom		
FE6609 - passage or closet		
FE6680 - passage lever x blank plate		
FE6624 - storeroom door	\$3,431.00	\$3,455.00
FE6665 - dormitory		
FE6620 - privacy		
FE6630 - privacy bath/bedroom		

# FE6600 Series Multi-Point Locks

JOSEF



## ROSES

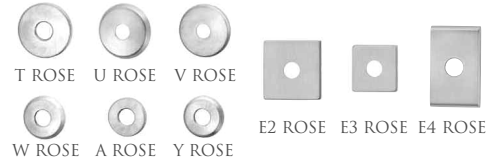

## ESCUTCHEONS



## THUMBTURNS<sup>3</sup>



1. Handed: specify hand when ordering
2. Contact factory for current lead time
3. Specify thumbturn as quick code. Thumbturn backplate will match shape of rose chosen (i.e. round or square). Not available with escutcheons.

613E Dark Oxidized Satin Bronze - Equivalent  
626 Satin Chromium Plated

605 Bright Brass, Clear Coated  
606 Satin Brass, Clear Coated  
611 Bright Bronze, Clear Coated  
612 Satin Bronze, Clear Coated  
613 Dark Oxidized Satin Bronze, Oil Rubbed  
613L Dark Oxidized Satin Bronze, Clear Coated

618 Bright Nickel Plated  
619 Satin Nickel Plated  
625 Bright Chromium Plated  
629 Bright Stainless Steel  
630 Satin Stainless Steel  
722 Black Oxidized Bronze, Oil Rubbed

### Function

Lever with Escutcheons: L, CE, RE1		
FE6618 - classroom	\$3,540.00	\$3,564.00
FE6609 - passage or closet		
FE6680 - passage lever x blank plate		
FE6624 - storeroom door		
FE6665 - dormitory		
FE6620 - privacy		
FE6630 - privacy bath/bedroom		
Lever with Roses: A, T, U, V, W, E2, E3, E4		
FE6618 - classroom	\$3,500.00	\$3,524.00
FE6609 - passage or closet		
FE6680 - passage lever x blank plate		
FE6624 - storeroom door		
FE6665 - dormitory		
FE6620 - privacy		
FE6630 - privacy bath/bedroom		



# FE6600 Series Multi-Point Locks

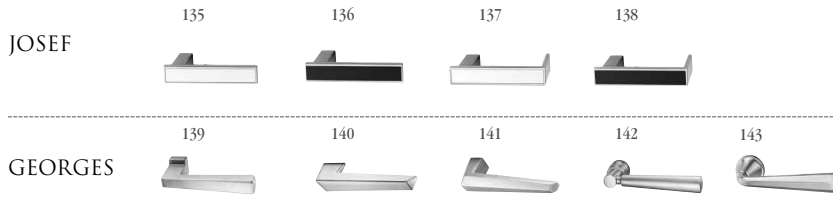

## ROSES

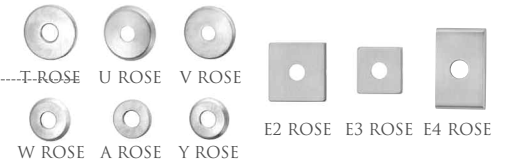

## ESCUTCHEONS



## THUMBTURNS<sup>3</sup>



1. Handed: specify hand when ordering
2. Contact factory for current lead time
3. Specify thumbturn as quick code. Thumbturn backplate will match shape of rose chosen (i.e. round or square). Not available with escutcheons.

613E	Dark Oxidized Satin Bronze - Equivalent	605	Bright Brass, Clear Coated	618	Bright Nickel Plated
626	Satin Chromium Plated	606	Satin Brass, Clear Coated	619	Satin Nickel Plated
		611	Bright Bronze, Clear Coated	625	Bright Chromium Plated
		612	Satin Bronze, Clear Coated	629	Bright Stainless Steel
		613	Dark Oxidized Satin Bronze, Oil Rubbed	630	Satin Stainless Steel
		613L	Dark Oxidized Satin Bronze, Clear Coated	722	Black Oxidized Bronze, Oil Rubbed

### Function

Lever with Escutcheons: L, CE, RE1		
FE6618 - classroom		
FE6609 - passage or closet		
FE6680 - passage lever x blank plate		
FE6624 - storeroom door	\$3,557.00	\$3,581.00
FE6665 - dormitory		
FE6620 - privacy		
FE6630 - privacy bath/bedroom		
Lever with Roses: A, T, U, V, W, E2, E3, E4		
FE6618 - classroom		
FE6609 - passage or closet		
FE6680 - passage lever x blank plate		
FE6624 - storeroom door	\$3,517.00	\$3,541.00
FE6665 - dormitory		
FE6620 - privacy		
FE6630 - privacy bath/bedroom		

# FE6600 Series Multi-Point Locks

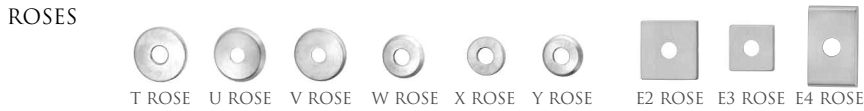

Specify thumbturn as quick code. Thumbturn backplate will match shape of rose chosen (i.e. round or square)

629	Bright Stainless Steel
630	Satin Stainless Steel

**Function**

Lever with Escutcheons: L, CE, RE1	
FE6618 - classroom FE6609 - passage or closet FE6680 - passage lever x blank plate FE6624 - storeroom door FE6665 - dormitory FE6620 - privacy FE6630 - privacy bath/bedroom	\$3,564.00

Lever with Roses: A, T, U, V, W, E2, E3, E4	
FE6618 - classroom FE6609 - passage or closet FE6680 - passage lever x blank plate FE6624 - storeroom door FE6665 - dormitory FE6620 - privacy FE6630 - privacy bath/bedroom	\$3,524.00

# FE6600 Series Multi-Point Locks

## PIET



## ROSES



## ESCUTCHEONS

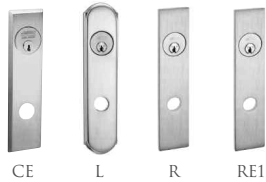

## THUMBTURNS



Specify thumbturn as quick code. Thumbturn backplate will match shape of rose chosen (i.e. round or square)

629	Bright Stainless Steel
630	Satin Stainless Steel

### Function

Lever with Escutcheons: L, CE, RE1	
FE6618 - classroom	\$3,581.00
FE6609 - passage or closet	
FE6680 - passage lever x blank plate	
FE6624 - storeroom door	
FE6665 - dormitory	
FE6620 - privacy	
FE6630 - privacy bath/bedroom	
Lever with Roses: A, T, U, V, W, E2, E3, E4	
FE6618 - classroom	\$3,541.00
FE6609 - passage or closet	
FE6680 - passage lever x blank plate	
FE6624 - storeroom door	
FE6665 - dormitory	
FE6620 - privacy	
FE6630 - privacy bath/bedroom	

**FE6600 Series**  
Multi-Point Locks

**Vandal Resistant Trim: ASV, CSV, DSV, ESV, LSV, NSV, PSV, RSV**

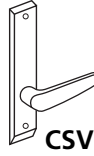

**CSV**

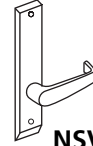

**NSV**

Lever: Cast  
Escutcheon: Cast

Description/Function	CSV, NSV Finish: 630
FE6680 - passage lever x blank plate FE6624 - storeroom door FE6665 - dormitory FE6630 - privacy bath/bedroom	\$3,895.00

# FE6600 Series

## Multi-Point Locks



### Cylinder & Keying Options

Description	Specify Quick Code	Add or Deduct
Conventional 6-pin	(standard)	No Charge
Conventional 7-pin	7P	Add \$2.00 per cylinder
Less Standard Cylinder	LC	Deduct \$83.00 per cylinder
Less Concealed Shell Cylinder	PO-LC	Add \$5.00 per lockset
Access 3 Patented	AP	No Charge
Access 3 Security	AS	Add \$54.00 per cylinder
Access 3 High Security, UL 437	AHS	Add \$76.00 per cylinder
Access 3 IC Patented	ACP	Add \$71.00 per cylinder
Access 3 IC Security	ACS	Add \$120.00 per cylinder
Access 3 IC High Security, UL 437	ACHS	Add \$140.00 per cylinder
Pyramid Security Fixed Core	PS	Add \$55.00 per cylinder
Pyramid Security IC	PCS	Add \$124.00 per cylinder
Pyramid High Security Fixed Core	PHS	Add \$82.00 per cylinder
Pyramid High Security IC	PCHS	Add \$152.00 per cylinder
Pyramid IC with Temporary Construction Core <sup>3</sup>	CTP	Add \$71.00 per cylinder
Pyramid IC with Temporary Disposable Core <sup>3</sup>	CTPD	No Charge
Pyramid IC Less Core	CLP	No Charge
Security <sup>4</sup>	HS	Add \$106.00 per cylinder
Security IC <sup>1,4</sup>	CHS	Add \$176.00 per cylinder
Blockout Function Cylinder	BO	Add \$105.00 per cylinder
IC 6-pin	C6	Add \$71.00 per cylinder
IC 6-pin with Temporary Construction Core (Red)	CT6R	Add \$71.00 per cylinder
IC 6-pin with Temporary Construction Core (Blue)	CT6B	Add \$71.00 per cylinder
IC 6-pin with Temporary Construction Core (Green)	CT6G	Add \$71.00 per cylinder
IC 6-pin with Temporary Disposable Core	CT6D	No Charge
IC 6-pin Less Core	CL6	No Charge
SFIC 6-pin with Less Core	CLS6	No Charge
IC 6-pin with SFIC disposable temporary core	CT6SD	No Charge
IC 7-pin	C7	Add \$73.00 per cylinder
IC 7-pin with Temporary Construction Core (Red)	CT7R	Add \$73.00 per cylinder
IC 7-pin with Temporary Construction Core (Blue)	CT7B	Add \$73.00 per cylinder
IC 7-pin with Temporary Construction Core (Green)	CT7G	Add \$73.00 per cylinder
IC 7-pin with Temporary Disposable Core	CT7D	Add \$2.00 per cylinder
IC 7-pin Less Core	CL7	Add \$2.00 per cylinder
SFIC 7-pin with Less Core	CLS7	Add \$2.00 per cylinder
IC 7-pin with SFIC disposable temporary core	CT7SD	Add \$2.00 per cylinder
Master Ring <sup>2</sup>	MR	Add \$65.00 per cylinder
Flex Head Cylinder, 6-pin (sectional trim)	FX6	Add \$69.00 per cylinder
Flex Head Cylinder, 7-pin (sectional trim)	FX7	Add \$72.00 per cylinder
Flex Head Master Ring (sectional trim)	FXM	Add \$118.00 per cylinder
Plug only to show, 6-pin (concealed shell) (available for M and R escutcheons and single cylinder functions only)	P06	Add \$85.00 per lockset
Plug only to show, 7-pin (concealed shell) (available for M and R escutcheons and single cylinder functions only)	P07	Add \$87.00 per lockset

Notes:

1. CHS ordered with CT6 option no charge.
3. Refer to Key construction core program, pg. 63 for example of CTP option pricing.
4. For existing systems only.

# FE6600 Series

## Multi-Point Locks



### Cylinder & Keying Options\* (con't)

Description	Specify Quick Code	Add or Deduct
0-Bitted with two blank keys <sup>5</sup>	(standard)	No Charge
Keyed Random <sup>4</sup>	KR	No Charge
Master keyed (all cylinders except 8000, 8020, 8027 IC core)	specify keyset	Add \$16.00 per cylinder
Master keyed Pyramid	specify keyset	Add \$16.00 per cylinder
Master keyed Security (including IC cylinder and core)	specify keyset	Add \$16.00 per cylinder
Master keyed (8000, 8020, 8027 IC core)	specify keyset	No Charge
Master keyed to customer bittings or sample key	specify keyset	Add \$16.00 per cylinder
Construction master keyed <sup>1,2</sup>	CMK	Add \$16.00 per cylinder
Visual key control (VKC)		
- No Stamping	VKC0	\$4.50
- Keys only	VKC1	No Charge
- Cylinders and Keys <sup>3</sup>	VKC2	\$8.00
- Cylinders only <sup>3</sup>	VKC3	\$8.00
Concealed key control (CKC)		
- CKC cylinders with VKC keys	CKC2	\$8.00
- CKC cylinders only <sup>3</sup>	CKC3	\$8.00
More than 2 keys per lock	KY# (e.g., KY6)	See page 64 - Cut Keys Section

**Notes:**

1. CMK Construction master keying charge is in addition to master keying charge.
2. CMK Construction master keying is not available in Pyramid series cylinders.
3. VKC2, VKC3, CKC3 are not available in Pyramid or Security series.
4. Pyramid series is not available keyed random.
5. Security series is not available 0-bitted.

### Strike Options\*

Lip Length	ANSI Straight Lip - Specify Quick Code	ANSI Curved Lip - Specify Quick Code	Add or Deduct
7/8"	SS078	N/A	No Charge

\* If door thickness is standard or has been specified and no special door or frame condition exist, then only the first two characters of the optional strike Quick Code must be specified (e.g. "SA").

The correct lip length will be determined by our order entry system based on the standard or specified door thickness.

# FE6600 Series

## Multi-Point Locks

### Door Thickness with Locksets Mortised on Center

Door Thickness	Sectional Rose Trim Specify Quick Code	Escutcheon <sup>1,2</sup> Trim Specify Quick Code	Add or Deduct
1-3/4" (standard)	—	—	No Charge

### Options

Description	Specify Quick Code	Add or Deduct
Split designs and split finishes	Outside Trim x Inside Trim	Higher set price prevails
Spanner head screws	M02	Add \$16.00 per lockset
Torx® head screws (n/a with N escutcheon)	M04	Add \$22.00 per lockset
Single Occupancy Indicator - Secure/Unsecure (Outside)	M19S*	Add \$85.00 per lockset
Single Occupancy Indicator - Vacant/Occupied (Outside)	M19V*	Add \$85.00 per lockset
Double Occupancy Indicator - Secure/Unsecure (Outside) Secure/Unsecure (Inside)	M19SN*	Add \$162.00 per lockset
Double Indicator Vacant/Occupied (Outside) Secure/Unsecure (Inside)	M19VN*	Add \$162.00 per lockset
Knurling outside and inside	M20 <sup>1</sup>	Add \$132.00 per lockset
Knurling outside only	M21 <sup>1</sup>	Add \$66.00 per lockset
Knurling inside only	M22 <sup>1</sup>	Add \$66.00 per lockset
Abrasive coat outside and inside	M23 <sup>1</sup>	Add \$82.00 per lockset
Abrasive coat inside only	M24 <sup>1</sup>	Add \$41.00 per lockset
Abrasive coat outside only	M25 <sup>1</sup>	Add \$41.00 per lockset
Working trim only	M31	See pages 101 thru 111

### Thumbturn Options

Specify door thickness	Specify Quick Code	Add or Deduct
Ergonomic	M34 <sup>2</sup>	Add \$14.00 per TT
Decorative	MT1	No Charge
Decorative square	MT2	No Charge
Decorative cylinder	MT3	No Charge



MT1



MT2



MT3

Notes:

1. Not available on Vineyard™ Collection.
2. M34 is not available with M19N, M19VN or M19SN.

Note: Thumbturn backplate will match shape of rose chosen (i.e. round or square)

### Strike Options

Part Number	Description
726F577	Top Strike Pack
726F587	Bottom Strike Pack
726F607	Center Strike Pack

**FE6600 Series**  
Multi-Point Locks





# FE6700

## Storm Shutter Multi-Point Latching System

### Standard Features

#### Handing

Device is handed

#### Shutter Thickness

FE6700 is for use with standard 1-3/4" thick shutters

#### Cylinder Furnished with:

Brass, 6-pin, L4 keyway, 0-bitted, 1-1/8" standard for FE6755 Classroom Function. Optional cylinders available; see Quick Codes

#### Warranty

Seven-year limited

#### UL Approved

Meets FEMA 361 and ICC 500 for inswing shutters 1'8" w x 3'0" h min to 4'0" w x 6'8" h max.

*Solid brass lever and heavy duty escutcheon*

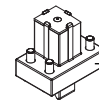
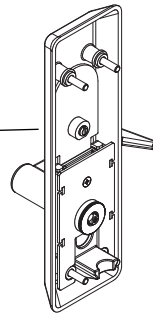

*5/8" stainless steel latch housing  
Through-hardened steel latchbolt 7/8" projection  
1/4-20 steel Holo-Krome® mounting screws*

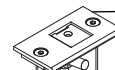

*1/8" thick, through-hardened steel front*

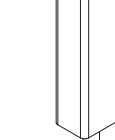

*11 gage steel 12" top bolt reinforcement*

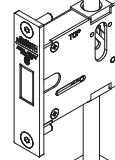

*Mortised centerbolt utilizes a one-piece stainless steel, 19/32" x 1-1/4" x 1" throw bolt, 3/16" thick stainless steel front, 13 gage steel case & cap*

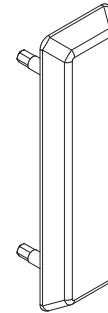

*11 gage steel 12" bottom bolt reinforcement*

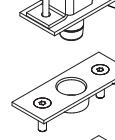

*1/8" steel reinforcement plate 3/4" steel nylon coated lower bolt, 3/4" projection*

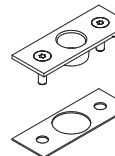

*Brass bottom strike 1/4-20 steel Holo-Krome fasteners*

### Ordering Example

#### Stock Order

Quantity	Series/ Function	Trim	Finish	Hand	Shutter Height
100	FE6780	FSH	626	RH	H0400

# FE6700

## Storm Shutter Multi-Point Latching System

**Lever: Solid cast**  
**Escutcheon: Forged**

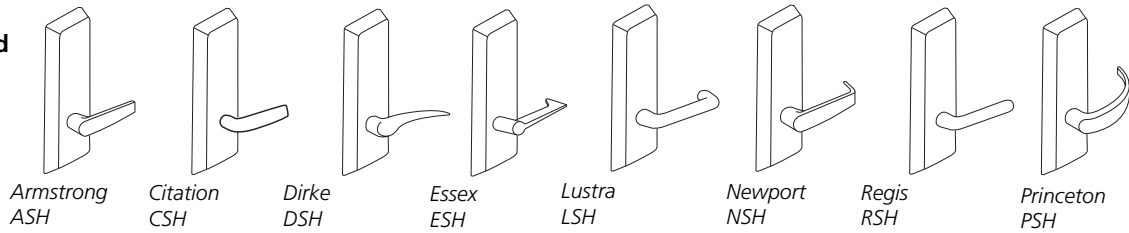

### FE6700 Series

Function	Description	ASH, CSH, DSH, ESH, LSH, NSH, PSH, RSH			
		Finish Group 1		Finish Group 2	
		613E Dark Oxidized Satin Bronze	605 Polished Brass	619 Satin Nickel	
		630 Satin Stainless Steel(1)	606 Satin Brass	625 Polished Chrome	
			611 Polished Bronze	629 Polished Stainless Steel(1)	
			612 Satin Bronze	626 Satin Chrome	
			613 Oil Rubbed Bronze	722 Black Oil Rubbed Bronze	
			618 Polished Nickel		
<b>For Typical Shutter Applications</b>					
FE6780	Passage Lever x Blank Plate				
<b>Optional Functions</b>					
FE6710	Passage or Closet				
FE6755	Classroom <sup>3</sup>				
			\$3,347.00		\$3,357.00

1. H escutcheon is a brass forging finished to match 629 and 630 finishes  
3. Collar is required depending on length and type of cylinder. See Miscellaneous Options section on page 205

**Lever: Solid Cast**  
**Escutcheon: Forged**

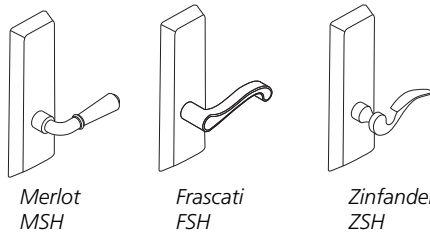

**Vineyard™**  
collection

### FE6700 Series

Function	Description	FSH, MSH, ZSH			
		Finish Group 1		Finish Group 2	
		613E Dark Oxidized Satin Bronze	605 Polished Brass	619 Satin Nickel	
		626 Satin Chrome	606 Satin Brass	625 Polished Chrome	
			611 Polished Bronze	722 Black Oil Rubbed Bronze	
			612 Satin Bronze		
			613 Oil Rubbed Bronze		
			618 Polished Nickel		
<b>For Typical Shutter Applications</b>					
FE6780	Passage Lever x Blank Plate				
<b>Optional Functions</b>					
FE6710	Passage or Closet				
FE6755	Classroom <sup>3</sup>				
			\$3,347.00		\$3,357.00

3. Collar is required depending on length and type of cylinder. See Miscellaneous Options section on page 205

# FE6700

## Storm Shutter Multi-Point Latching System



### Optional Cylinder & Keying Options

Description	Specify Quick Code	Add or Deduct
Conventional 6-pin	6P**	Add \$83.00 per cylinder
Conventional 7-pin	7P	Add \$85.00 per cylinder
Access 3 Patented	AP	Add \$83.00 per cylinder
Access 3 Security	AS	Add \$132.00 per cylinder
Access 3 High Security, UL 437	AHS	Add \$152.00 per cylinder
Access 3 IC Patented	ACP	Add \$154.00 per cylinder
Access 3 IC Security	ACS	Add \$203.00 per cylinder
Access 3 IC High Security, UL 437	ACHS	Add \$223.00 per cylinder
Pyramid Security fixed core	PS	Add \$138.00 per cylinder
Pyramid Security IC	PCS	Add \$197.00 per cylinder
Pyramid High Security fixed core	PHS	Add \$167.00 per cylinder
Pyramid High Security IC	PCHS	Add \$235.00 per cylinder
Pyramid IC with temporary construction core	CTP	Add \$154.00 per cylinder
Pyramid IC with temporary disposable core	CTPD	Add \$83.00 per cylinder
Pyramid IC less core	CLP	Add \$83.00 per cylinder
Security	HS	Add \$189.00 per cylinder
Security IC	CHS	Add \$259.00 per cylinder
Blockout function	BO	Add \$172.00 per cylinder
IC 6-pin	C6	Add \$154.00 per cylinder
IC 6-pin with temporary construction core (Red)	CT6R	Add \$154.00 per cylinder
IC 6-pin with temporary construction core (Blue)	CT6B	Add \$154.00 per cylinder
IC 6-pin with temporary construction core (Green)	CT6G	Add \$154.00 per cylinder
IC 6-pin with temporary disposable core	CT6D	Add \$83.00 per cylinder
IC 6-pin less core	CL6	Add \$83.00 per cylinder
SFIC 6-pin with Less Core	CLS6	Add \$83.00 per cylinder
IC 6-pin with SFIC disposable temporary core	CT6SD	Add \$83.00 per cylinder
IC 7-pin	C7	Add \$158.00 per cylinder
IC 7-pin with temporary construction core (Red)	CT7R	Add \$158.00 per cylinder
IC 7-pin with temporary construction core (Blue)	CT7B	Add \$158.00 per cylinder
IC 7-pin with temporary construction core (Green)	CT7G	Add \$158.00 per cylinder
IC 7-pin with temporary disposable core	CT7D	Add \$85.00 per cylinder
IC 7-pin less core	CL7	Add \$85.00 per cylinder
SFIC 7-pin with Less Core	CLS7	Add \$85.00 per cylinder
IC 7-pin with SFIC disposable temporary core	CT7SD	Add \$85.00 per cylinder

\*Optional dogging cylinder will be furnished with the same mechanism and keyed alike with the trim cylinder, unless otherwise specified. If different keying or cylinder type is required, specify outside (trim) first, then inside (dogging) cylinder.

\*\*6P cylinder option is supplied in 6-pin, L4 keyway, 0-bitted with two nickel silver keys.

# FE6700

## Storm Shutter Multi-Point Latching System



### Optional Cylinder & Keying Options (con't)

Description	Specify	Add or Deduct
0-Bitted with two blank keys <sup>5</sup>	(standard)	No Charge
Keyed Random <sup>4</sup>	KR	No Charge
Master keyed (all cylinders except 8000, 8020, 8027 IC core)	specify keyset	Add \$16.00 per cylinder
Master keyed Pyramid	specify keyset	Add \$16.00 per cylinder
Master keyed Security (including IC cylinder and core)	specify keyset	Add \$16.00 per cylinder
Master keyed (8000, 8020, 8027 IC core)	specify keyset	No Charge
Master keyed to customer bittings or sample key	specify keyset	Add \$16.00 per cylinder
Construction master keyed <sup>1,2</sup>	CMK	Add \$16.00 per cylinder
Visual key control (VKC)		
- No Stamping	VKC0	\$4.50
- Keys only	VKC1	No Charge
- Cylinders and Keys <sup>3</sup>	VKC2	\$8.00
- Cylinders only <sup>3</sup>	VKC3	\$8.00
Concealed key control (CKC)		
- CKC cylinders with VKC keys	CKC2	\$8.00
- CKC cylinders only <sup>3</sup>	CKC3	\$8.00
More than 2 keys per lock	KY# (e.g., KY6)	See page 66 - Cut Keys Section

Notes:

1. CMK Construction master keying charge is in addition to master keying charge.
2. CMK Construction master keying is not available in Pyramid series cylinders.
3. VKC2, VKC3, CKC3 are not available in Pyramid or Security series.
4. Pyramid series is not available keyed random.
5. Security series is not available 0-bitted.

### Shutter Thickness

Description	Specify
1-3/4"	(standard)

### Shutter Height Options

Description	Specify
3'0" - 4'6"	H0400
4'6" - 6'8"	H0500

### Miscellaneous Options

Description	Specify	Add or Deduct
Torx Screws	M04	Add \$16.00 per lockset
1-1/8" cylinder collar (for 6-pin mortise cylinder) <sup>12</sup>	721F36	No Charge
1-1/4" cylinder collar (for 7-pin mortise cylinder) <sup>12</sup>	721F37	No Charge
1-1/2" cylinder collar (for 7-pin IC mortise cylinder) <sup>12</sup>	721F38	No Charge
MicroShield® Antimicrobial finish coating	630C	Add \$76.00 per lockset
<i>MicroShield</i> Antimicrobial finish coating	626C	Add \$76.00 per lockset

Notes:

1. For optional FE6755 classroom function, collar is required depending on length and type of cylinder.
2. Specify as optional collar when ordering cylinders only.

# MP9800 Series

## Multi-Point Vertical Rod Lock

### Standard Features

#### Handing

Field Reversible.

#### Doors

1-3/4" (44mm) door thickness standard,  
2-1/4" backset standard.

#### Mounting

Supplied fasteners are for metal doors with through-bolts for trim.

#### Rods

Steel. Top and bottom bolt travels 7/16" (11mm)  
Projection adjustable up to 3/4" (19mm).

#### Latching

Top and Bottom or Top only (M55).

#### Trim

Available with all lever designs.

#### Cylinder

See cylinders page 12.

#### Applications

Single or Double Door.

#### Thermal Pins

MP9800A x M55: devices are supplied with ONE thermal pin per  
fire-rated device, for installation on pairs of fire-rated doors.

#### Warranty

5 year.



Available Function Combinations:		Inside Function (N)									
		10	45*	49*	50	52	55*	59*	903*	905*	
Outside Function (E)	Blank Escutcheon Plate	01	X	X	X			X	X	X	X
	Passage only (No cylinder)	10	X	X	X			X	X		
	No outside Operation (No Cylinder); Pull Only	40+	X	X	X					X	X
	Class Room Key Outside Unlocks/locks Trim	45	X	X	X						
	Key unlocks Trim; Trim retracts latch; Trim relocks when key is removed	49	X	X	X					X	X
	Freewheeling Trim; No Outside Operation	50						X	X		
	Key outside unlocks/locks O/S trim; Key inside unlocks/locks O/S trim	52					X				
	Freewheeling Trim; Key Outside Unlocks/locks Trim	55	X			X		X	X		
	Freewheeling Trim; Key unlocks Trim;	59	X		X		X	X			
	Trim retracts latch/Trim relocks when key is removed										
	Electrified Trim - Fail Safe	903	X	X	X						X
Electrified Trim - Fail Secure	905	X	X	X						X	X

\* **Not recommended for use on any door used for Life Safety egress**  
+ **Rigid lever**

### Ordering Examples

Quantity	Device	Exterior Trim/Function			Interior Trim/Function			Finish	Hand	Door Thickness	Door Height	Misc. Options
		Lever	Exterior	Function	Lever	Interior	Function					
65	MP9800	D	E	49	D	N	10	605	LHR	D214	H0800	M55

### Contract/Detailed Order

Qty	Keyset	Series	Exterior Trim/Function			Interior Trim/Function			Finish	Hand	Door Thickness	Door Height	Misc. Options	Cylinder Option
			Lever	Exterior	Function	Lever	Interior	Function						
36	AA1	MP9800A	101	E	50	101	N	55	626	LHR	D214	H1000	M93	7P

# MP9800 Series

## Multi-Point Vertical Rod Lock

**Lever: Solid Cast  
Escutcheon: Forged**

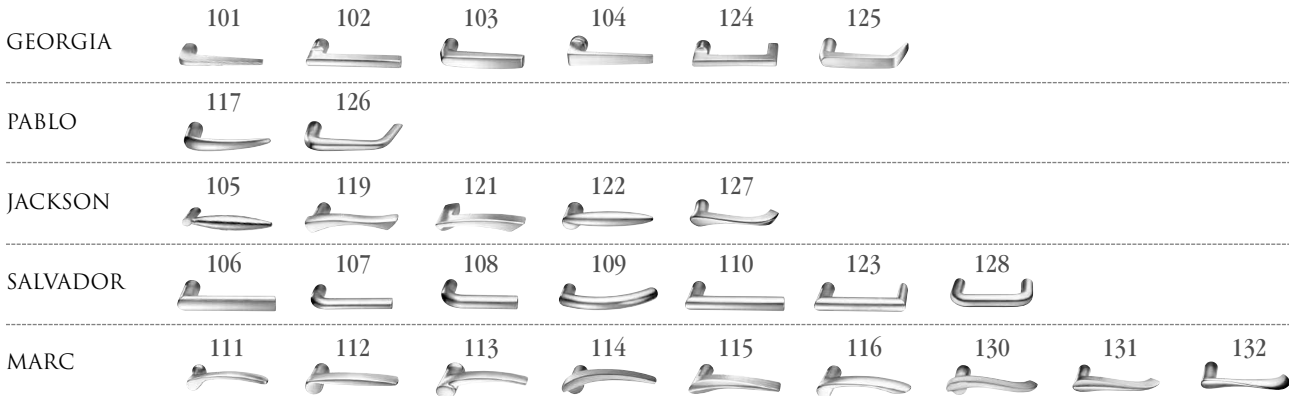
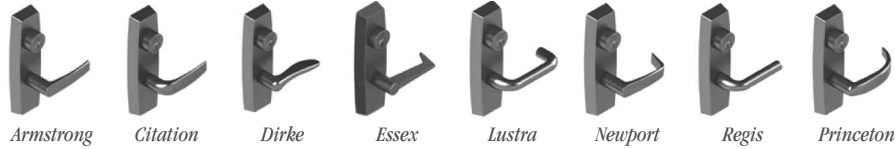

Note: Must designate E for exterior function or N for interior function when specifying order.

MP9800		613E, 626	605 606 611 612 613 618 625
Lever (E) x 01 x Lever (N) x *49	Blank Escutcheon Plate		
Lever (E) x 01 x Lever (N) x *45	Blank Escutcheon Plate		
Lever (E) x 01 x Lever (N) x 10	Blank Escutcheon Plate		
Lever (E) x 01 x Lever (N) x *55	Blank Escutcheon Plate		
Lever (E) x 01 x Lever (N) x 59	Blank Escutcheon Plate		
Lever (E) x 10 x Lever (N) x *49	Passage only (No cylinder)		
Lever (E) x 10 x Lever (N) x *45	Passage only (No cylinder)		
Lever (E) x 10 x Lever (N) x 10	Passage only (No cylinder)		
Lever (E) x 10 x Lever (N) x *55	Passage only (No cylinder)		
Lever (E) x 10 x Lever (N) x *59	Passage only (No cylinder)	\$1,928.00	\$1,999.00
Lever (E) x 40 x Lever (N) x *49	No outside Operation (No Cylinder); Pull Only		
Lever (E) x 40 x Lever (N) x *45	No outside Operation (No Cylinder); Pull Only		
Lever (E) x 40 x Lever (N) x 10	No outside Operation (No Cylinder); Pull Only		
Lever (E) x 45 x Lever (N) x *49	Class Room Key Outside Unlocks/locks Trim		
Lever (E) x 45 x Lever (N) x *45	Class Room Key Outside Unlocks/locks Trim		
Lever (E) x 45 x Lever (N) x 10	Class Room Key Outside Unlocks/locks Trim		
Lever (E) x 49 x Lever (N) x *10	Key unlocks Trim; Trim retracts latch; Trim relocks when key is removed		
Lever (E) x 49 x Lever (N) x *45	Key unlocks Trim; Trim retracts latch; Trim relocks when key is removed		
Lever (E) x 49 x Lever (N) x *49	Key unlocks Trim; Trim retracts latch; Trim relocks when key is removed		

\* Not recommended for use on any door used for Life Safety egress.

# MP9800 Series

## Multi-Point Vertical Rod Lock



<b>MP9800 Freewheeling Trim</b>		613E, 626	605 606 611 612 613 618 625
Lever (E) x 50 x Lever (N) x *55	Freewheeling Trim; No Outside Operation	\$1,928.00	\$1,999.00
Lever (E) x 50 x Lever (N) x *59	Freewheeling Trim; No Outside Operation		
Lever (E) x 52 x Lever (N) x 52	Key outside unlocks/locks O/S trim; Key inside unlocks/locks O/S trim		
Lever (E) x 55 x Lever (N) x *10	Freewheeling Trim; Key Outside Unlocks/locks Trim		
Lever (E) x 55 x Lever (N) x 50	Freewheeling Trim; Key Outside Unlocks/locks Trim		
Lever (E) x 55 x Lever (N) x *55	Freewheeling Trim; Key Outside Unlocks/locks Trim		
Lever (E) x 55 x Lever (N) x *59	Freewheeling Trim; Key Outside Unlocks/locks Trim		
Lever (E) x 59 x Lever (N) x *10	Freewheeling Trim; Key unlocks Trim; Trim retracts latch/Trim relocks when key is removed		
Lever (E) x 59 x Lever (N) x 50	Freewheeling Trim; Key unlocks Trim; Trim retracts latch/Trim relocks when key is removed		
Lever (E) x 59 x Lever (N) x *55	Freewheeling Trim; Key unlocks Trim; Trim retracts latch/Trim relocks when key is removed		
Lever (E) x 59 x Lever (N) x *59	Freewheeling Trim; Key unlocks Trim; Trim retracts latch/Trim relocks when key is removed		
<b>MP9800 Electromechanical</b>			
Lever (E) x 01 x Lever (N) x *903	Blank Escutcheon Plate	\$2,088.00	\$2,159.00
Lever (E) x 01 x Lever (N) x *905	Blank Escutcheon Plate		
Lever (E) x 40 x Lever (N) x *903	No outside Operation (No Cylinder); Pull Only		
Lever (E) x 40 x Lever (N) x *905	No outside Operation (No Cylinder); Pull Only		
Lever (E) x 49 x Lever (N) x *903	Key unlocks Trim; Trim retracts latch; Trim relocks when key is removed		
Lever (E) x 49 x Lever (N) x *905	Key unlocks Trim; Trim retracts latch; Trim relocks when key is removed		
Lever (E) x 903 x Lever (N) x 10	Electrified Trim - Fail Safe		
Lever (E) x 903 x Lever (N) x *45	Electrified Trim - Fail Safe		
Lever (E) x 905 x Lever (N) x 10	Electrified Trim - Fail Secure		
Lever (E) x 905 x Lever (N) x *45	Electrified Trim - Fail Secure		
Lever (E) x 905 x Lever (N) x *903	Electrified Trim - Fail Secure		
Lever (E) x 905 x Lever (N) x *905	Electrified Trim - Fail Secure		
Lever (E) x 903 x Lever (N) x *903	Electrified Trim - Fail Safe		
Lever (E) x 903 x Lever (N) x *905	Electrified Trim - Fail Safe		

\* Not recommended for use on any door used for Life Safety egress.

# MP9800 Series

## Multi-Point Vertical Rod Lock

**Lever: Solid Cast  
Escutcheon: Forged**

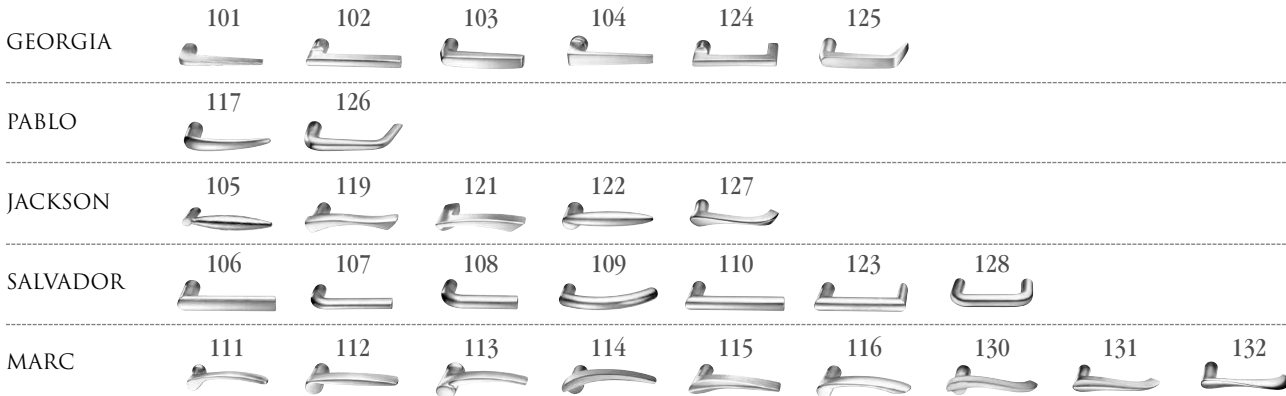
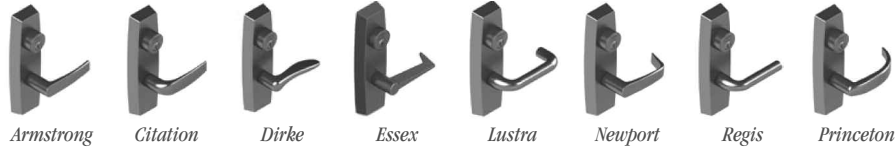

Note: Must designate E for exterior function or N for interior function when specifying order.

MP9800A		613E, 626	605 606 611 612 613 618 625
Lever (E) x 01 x Lever (N) x *49	Blank Escutcheon Plate		
Lever (E) x 01 x Lever (N) x *45	Blank Escutcheon Plate		
Lever (E) x 01 x Lever (N) x 10	Blank Escutcheon Plate		
Lever (E) x 01 x Lever (N) x *55	Blank Escutcheon Plate		
Lever (E) x 01 x Lever (N) x *59	Blank Escutcheon Plate		
Lever (E) x 10 x Lever (N) x *49	Passage only (No cylinder)		
Lever (E) x 10 x Lever (N) x *45	Passage only (No cylinder)		
Lever (E) x 10 x Lever (N) x 10	Passage only (No cylinder)		
Lever (E) x 10 x Lever (N) x *55	Passage only (No cylinder)		
Lever (E) x 10 x Lever (N) x *59	Passage only (No cylinder)	\$2,091.00	\$2,162.00
Lever (E) x 40 x Lever (N) x *49	No outside Operation (No Cylinder); Pull Only		
Lever (E) x 40 x Lever (N) x *45	No outside Operation (No Cylinder); Pull Only		
Lever (E) x 40 x Lever (N) x 10	No outside Operation (No Cylinder); Pull Only		
Lever (E) x 45 x Lever (N) x *49	Class Room Key Outside Unlocks/locks Trim		
Lever (E) x 45 x Lever (N) x *45	Class Room Key Outside Unlocks/locks Trim		
Lever (E) x 45 x Lever (N) x 10	Class Room Key Outside Unlocks/locks Trim		
Lever (E) x 49 x Lever (N) x *10	Key unlocks Trim; Trim retracts latch; Trim relocks when key is removed		
Lever (E) x 49 x Lever (N) x *45	Key unlocks Trim; Trim retracts latch; Trim relocks when key is removed		
Lever (E) x 49 x Lever (N) x *49	Key unlocks Trim; Trim retracts latch; Trim relocks when key is removed		

\* Not recommended for use on any door used for Life Safety egress.



# MP9800 Series

## Multi-Point Vertical Rod Lock



<b>MP9800A Freewheeling Trim</b>		<b>613E, 626</b>	<b>605 606 611 612 613 618 625</b>		
Lever (E) x 50 x Lever (N) x *55	Freewheeling Trim; No Outside Operation	\$2,091.00	\$2,162.00		
Lever (E) x 50 x Lever (N) x *59	Freewheeling Trim; No Outside Operation				
Lever (E) x 52 x Lever (N) x 52	Key outside unlocks/locks O/S trim; Key inside unlocks/locks O/S trim				
Lever (E) x 55 x Lever (N) x *10	Freewheeling Trim; Key Outside Unlocks/locks Trim				
Lever (E) x 55 x Lever (N) x 50	Freewheeling Trim; Key Outside Unlocks/locks Trim				
Lever (E) x 55 x Lever (N) x *55	Freewheeling Trim; Key Outside Unlocks/locks Trim				
Lever (E) x 55 x Lever (N) x *59	Freewheeling Trim; Key Outside Unlocks/locks Trim				
Lever (E) x 59 x Lever (N) x *10	Freewheeling Trim; Key unlocks Trim; Trim retracts latch/Trim relocks when key is removed				
Lever (E) x 59 x Lever (N) x 50	Freewheeling Trim; Key unlocks Trim; Trim retracts latch/Trim relocks when key is removed				
Lever (E) x 59 x Lever (N) x *55	Freewheeling Trim; Key unlocks Trim; Trim retracts latch/Trim relocks when key is removed				
Lever (E) x 59 x Lever (N) x *59	Freewheeling Trim; Key unlocks Trim; Trim retracts latch/Trim relocks when key is removed				
<b>MP9800A Electromechanical</b>					
Lever (E) x 01 x Lever (N) x *903	Blank Escutcheon Plate	\$2,251.00	\$2,322.00		
Lever (E) x 01 x Lever (N) x *905	Blank Escutcheon Plate				
Lever (E) x 40 x Lever (N) x *903	No outside Operation (No Cylinder); Pull Only				
Lever (E) x 40 x Lever (N) x *905	No outside Operation (No Cylinder); Pull Only				
Lever (E) x 49 x Lever (N) x *903	Key unlocks Trim; Trim retracts latch; Trim relocks when key is removed				
Lever (E) x 49 x Lever (N) x *905	Key unlocks Trim; Trim retracts latch; Trim relocks when key is removed				
Lever (E) x 903 x Lever (N) x 10	Electrified Trim - Fail Safe				
Lever (E) x 903 x Lever (N) x *45	Electrified Trim - Fail Safe				
Lever (E) x 905 x Lever (N) x 10	Electrified Trim - Fail Secure				
Lever (E) x 905 x Lever (N) x *45	Electrified Trim - Fail Secure				
Lever (E) x 905 x Lever (N) x *903	Electrified Trim - Fail Secure			\$2,414.00	\$2,485.00
Lever (E) x 905 x Lever (N) x *905	Electrified Trim - Fail Secure				
Lever (E) x 903 x Lever (N) x *903	Electrified Trim - Fail Safe				
Lever (E) x 903 x Lever (N) x *905	Electrified Trim - Fail Safe				

\* Not recommended for use on any door used for Life Safety egress.

**MP9800 Series**  
Multi-Point Vertical Rod Lock



<b>MP9800</b>		
	Piet 21G, 21L, 21M, 21S, 21W, 23M, 25M, 27M	629, 630
Lever (E) x 01 x Lever (N) x *49	Blank Escutcheon Plate	\$2,103.00
Lever (E) x 01 x Lever (N) x *45	Blank Escutcheon Plate	
Lever (E) x 01 x Lever (N) x 10	Blank Escutcheon Plate	
Lever (E) x 01 x Lever (N) x *55	Blank Escutcheon Plate	
Lever (E) x 01 x Lever (N) x 59	Blank Escutcheon Plate	
Lever (E) x 10 x Lever (N) x *49	Passage only (No cylinder)	
Lever (E) x 10 x Lever (N) x *45	Passage only (No cylinder)	
Lever (E) x 10 x Lever (N) x 10	Passage only (No cylinder)	
Lever (E) x 10 x Lever (N) x *55	Passage only (No cylinder)	
Lever (E) x 10 x Lever (N) x *59	Passage only (No cylinder)	
Lever (E) x 40 x Lever (N) x *49	No outside Operation (No Cylinder); Pull Only	
Lever (E) x 40 x Lever (N) x *45	No outside Operation (No Cylinder); Pull Only	
Lever (E) x 40 x Lever (N) x 10	No outside Operation (No Cylinder); Pull Only	
Lever (E) x 45 x Lever (N) x *49	Class Room Key Outside Unlocks/locks Trim	
Lever (E) x 45 x Lever (N) x *45	Class Room Key Outside Unlocks/locks Trim	
Lever (E) x 45 x Lever (N) x 10	Class Room Key Outside Unlocks/locks Trim	
Lever (E) x 49 x Lever (N) x *10	Key unlocks Trim; Trim retracts latch; Trim relocks when key is removed	
Lever (E) x 49 x Lever (N) x *45	Key unlocks Trim; Trim retracts latch; Trim relocks when key is removed	
Lever (E) x 49 x Lever (N) x *49	Key unlocks Trim; Trim retracts latch; Trim relocks when key is removed	
<b>MP9800 Freewheeling Trim</b>		
Lever (E) x 50 x Lever (N) x *55	Freewheeling Trim; No Outside Operation	\$2,103.00
Lever (E) x 50 x Lever (N) x *59	Freewheeling Trim; No Outside Operation	
Lever (E) x 52 x Lever (N) x 52	Key outside unlocks/locks O/S trim; Key inside unlocks/locks O/S trim	
Lever (E) x 55 x Lever (N) x *10	Freewheeling Trim; Key Outside Unlocks/locks Trim	
Lever (E) x 55 x Lever (N) x 50	Freewheeling Trim; Key Outside Unlocks/locks Trim	
Lever (E) x 55 x Lever (N) x *55	Freewheeling Trim; Key Outside Unlocks/locks Trim	
Lever (E) x 55 x Lever (N) x *59	Freewheeling Trim; Key Outside Unlocks/locks Trim	
Lever (E) x 59 x Lever (N) x *10	Freewheeling Trim; Key unlocks Trim; Trim retracts latch/Trim relocks when key is removed	
Lever (E) x 59 x Lever (N) x 50	Freewheeling Trim; Key unlocks Trim; Trim retracts latch/Trim relocks when key is removed	
Lever (E) x 59 x Lever (N) x *55	Freewheeling Trim; Key unlocks Trim; Trim retracts latch/Trim relocks when key is removed	
Lever (E) x 59 x Lever (N) x *59	Freewheeling Trim; Key unlocks Trim; Trim retracts latch/Trim relocks when key is removed	
<b>MP9800 Electromechanical</b>		
Lever (E) x 01 x Lever (N) x *903	Blank Escutcheon Plate	\$2,263.00
Lever (E) x 01 x Lever (N) x *905	Blank Escutcheon Plate	
Lever (E) x 40 x Lever (N) x *903	No outside Operation (No Cylinder); Pull Only	
Lever (E) x 40 x Lever (N) x *905	No outside Operation (No Cylinder); Pull Only	
Lever (E) x 49 x Lever (N) x *903	Key unlocks Trim; Trim retracts latch; Trim relocks when key is removed	
Lever (E) x 49 x Lever (N) x *905	Key unlocks Trim; Trim retracts latch; Trim relocks when key is removed	
Lever (E) x 903 x Lever (N) x 10	Electrified Trim - Fail Safe	\$2,426.00
Lever (E) x 903 x Lever (N) x *45	Electrified Trim - Fail Safe	
Lever (E) x 905 x Lever (N) x 10	Electrified Trim - Fail Secure	
Lever (E) x 905 x Lever (N) x *45	Electrified Trim - Fail Secure	
Lever (E) x 905 x Lever (N) x *903	Electrified Trim - Fail Secure	
Lever (E) x 905 x Lever (N) x *905	Electrified Trim - Fail Secure	
Lever (E) x 903 x Lever (N) x *903	Electrified Trim - Fail Safe	
Lever (E) x 903 x Lever (N) x *905	Electrified Trim - Fail Safe	

\* Not recommended for use on any door used for Life Safety egress.

# MP9800 Series

## Multi-Point Vertical Rod Lock



PIET\*



<b>MP9800A</b>		
	Piet 21G, 21L, 21M, 21S, 21W, 23M, 25M, 27M	629, 630
Lever (E) x 01 x Lever (N) x *49	Blank Escutcheon Plate	\$2,266.00
Lever (E) x 01 x Lever (N) x *45	Blank Escutcheon Plate	
Lever (E) x 01 x Lever (N) x 10	Blank Escutcheon Plate	
Lever (E) x 01 x Lever (N) x *55	Blank Escutcheon Plate	
Lever (E) x 01 x Lever (N) x 59	Blank Escutcheon Plate	
Lever (E) x 10 x Lever (N) x *49	Passage only (No cylinder)	
Lever (E) x 10 x Lever (N) x *45	Passage only (No cylinder)	
Lever (E) x 10 x Lever (N) x 10	Passage only (No cylinder)	
Lever (E) x 10 x Lever (N) x *55	Passage only (No cylinder)	
Lever (E) x 10 x Lever (N) x *59	Passage only (No cylinder)	
Lever (E) x 40 x Lever (N) x *49	No outside Operation (No Cylinder); Pull Only	
Lever (E) x 40 x Lever (N) x *45	No outside Operation (No Cylinder); Pull Only	
Lever (E) x 40 x Lever (N) x 10	No outside Operation (No Cylinder); Pull Only	
Lever (E) x 45 x Lever (N) x *49	Class Room Key Outside Unlocks/locks Trim	
Lever (E) x 45 x Lever (N) x *45	Class Room Key Outside Unlocks/locks Trim	
Lever (E) x 45 x Lever (N) x 10	Class Room Key Outside Unlocks/locks Trim	
Lever (E) x 49 x Lever (N) x *10	Key unlocks Trim; Trim retracts latch; Trim relocks when key is removed	
Lever (E) x 49 x Lever (N) x *45	Key unlocks Trim; Trim retracts latch; Trim relocks when key is removed	
Lever (E) x 49 x Lever (N) x *49	Key unlocks Trim; Trim retracts latch; Trim relocks when key is removed	
<b>MP9800A Freewheeling Trim</b>		
Lever (E) x 50 x Lever (N) x *55	Freewheeling Trim; No Outside Operation	\$2,266.00
Lever (E) x 50 x Lever (N) x *59	Freewheeling Trim; No Outside Operation	
Lever (E) x 52 x Lever (N) x 52	Key outside unlocks/locks O/S trim; Key inside unlocks/locks O/S trim	
Lever (E) x 55 x Lever (N) x *10	Freewheeling Trim; Key Outside Unlocks/locks Trim	
Lever (E) x 55 x Lever (N) x 50	Freewheeling Trim; Key Outside Unlocks/locks Trim	
Lever (E) x 55 x Lever (N) x *55	Freewheeling Trim; Key Outside Unlocks/locks Trim	
Lever (E) x 55 x Lever (N) x *59	Freewheeling Trim; Key Outside Unlocks/locks Trim	
Lever (E) x 59 x Lever (N) x *10	Freewheeling Trim; Key unlocks Trim; Trim retracts latch/Trim relocks when key is removed	
Lever (E) x 59 x Lever (N) x 50	Freewheeling Trim; Key unlocks Trim; Trim retracts latch/Trim relocks when key is removed	
Lever (E) x 59 x Lever (N) x *55	Freewheeling Trim; Key unlocks Trim; Trim retracts latch/Trim relocks when key is removed	
Lever (E) x 59 x Lever (N) x *59	Freewheeling Trim; Key unlocks Trim; Trim retracts latch/Trim relocks when key is removed	
<b>MP9800A Electromechanical</b>		
Lever (E) x 01 x Lever (N) x *903	Blank Escutcheon Plate	\$2,426.00
Lever (E) x 01 x Lever (N) x *905	Blank Escutcheon Plate	
Lever (E) x 40 x Lever (N) x *903	No outside Operation (No Cylinder); Pull Only	
Lever (E) x 40 x Lever (N) x *905	No outside Operation (No Cylinder); Pull Only	
Lever (E) x 49 x Lever (N) x *903	Key unlocks Trim; Trim retracts latch; Trim relocks when key is removed	
Lever (E) x 49 x Lever (N) x *905	Key unlocks Trim; Trim retracts latch; Trim relocks when key is removed	
Lever (E) x 903 x Lever (N) x 10	Electrified Trim - Fail Safe	
Lever (E) x 903 x Lever (N) x *45	Electrified Trim - Fail Safe	
Lever (E) x 905 x Lever (N) x 10	Electrified Trim - Fail Secure	
Lever (E) x 905 x Lever (N) x *45	Electrified Trim - Fail Secure	
Lever (E) x 905 x Lever (N) x *903	Electrified Trim - Fail Secure	\$2,589.00
Lever (E) x 905 x Lever (N) x *905	Electrified Trim - Fail Secure	
Lever (E) x 903 x Lever (N) x *903	Electrified Trim - Fail Safe	
Lever (E) x 903 x Lever (N) x *905	Electrified Trim - Fail Safe	

\* Not recommended for use on any door used for Life Safety egress.

# MP9800 Series

## Multi-Point Vertical Rod Lock

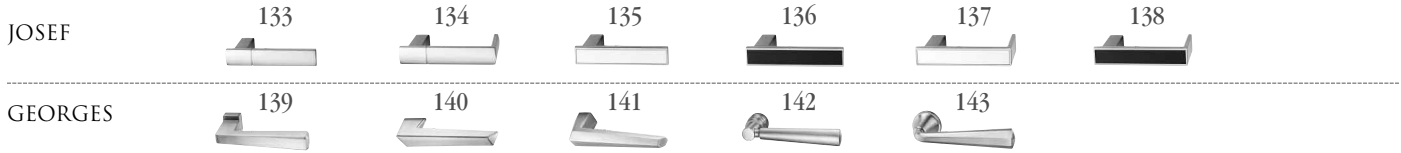

<b>MP9800</b>			
	<b>Josef, Georges Levers</b>	<b>613E, 626</b>	<b>605 606 611 612 613 618 625</b>
Lever (E) x 01 x Lever (N) x *49	Blank Escutcheon Plate	\$2,026.00	\$2,103.00
Lever (E) x 01 x Lever (N) x *45	Blank Escutcheon Plate		
Lever (E) x 01 x Lever (N) x 10	Blank Escutcheon Plate		
Lever (E) x 01 x Lever (N) x *55	Blank Escutcheon Plate		
Lever (E) x 01 x Lever (N) x 59	Blank Escutcheon Plate		
Lever (E) x 10 x Lever (N) x *49	Passage only (No cylinder)		
Lever (E) x 10 x Lever (N) x *45	Passage only (No cylinder)		
Lever (E) x 10 x Lever (N) x 10	Passage only (No cylinder)		
Lever (E) x 10 x Lever (N) x *55	Passage only (No cylinder)		
Lever (E) x 10 x Lever (N) x *59	Passage only (No cylinder)		
Lever (E) x 40 x Lever (N) x *49	No outside Operation (No Cylinder); Pull Only		
Lever (E) x 40 x Lever (N) x *45	No outside Operation (No Cylinder); Pull Only		
Lever (E) x 40 x Lever (N) x 10	No outside Operation (No Cylinder); Pull Only		
Lever (E) x 45 x Lever (N) x *49	Class Room Key Outside Unlocks/locks Trim		
Lever (E) x 45 x Lever (N) x *45	Class Room Key Outside Unlocks/locks Trim		
Lever (E) x 45 x Lever (N) x 10	Class Room Key Outside Unlocks/locks Trim		
Lever (E) x 49 x Lever (N) x *10	Key unlocks Trim; Trim retracts latch; Trim relocks when key is removed		
Lever (E) x 49 x Lever (N) x *45	Key unlocks Trim; Trim retracts latch; Trim relocks when key is removed		
Lever (E) x 49 x Lever (N) x *49	Key unlocks Trim; Trim retracts latch; Trim relocks when key is removed		
<b>MP9800 Freewheeling Trim</b>			
Lever (E) x 50 x Lever (N) x *55	Freewheeling Trim; No Outside Operation	\$2,026.00	\$2,103.00
Lever (E) x 50 x Lever (N) x *59	Freewheeling Trim; No Outside Operation		
Lever (E) x 52 x Lever (N) x 52	Key outside unlocks/locks O/S trim; Key inside unlocks/locks O/S trim		
Lever (E) x 55 x Lever (N) x *10	Freewheeling Trim; Key Outside Unlocks/locks Trim		
Lever (E) x 55 x Lever (N) x 50	Freewheeling Trim; Key Outside Unlocks/locks Trim		
Lever (E) x 55 x Lever (N) x *55	Freewheeling Trim; Key Outside Unlocks/locks Trim		
Lever (E) x 55 x Lever (N) x *59	Freewheeling Trim; Key Outside Unlocks/locks Trim		
Lever (E) x 59 x Lever (N) x *10	Freewheeling Trim; Key unlocks Trim; Trim retracts latch/Trim relocks when key is removed		
Lever (E) x 59 x Lever (N) x 50	Freewheeling Trim; Key unlocks Trim; Trim retracts latch/Trim relocks when key is removed		
Lever (E) x 59 x Lever (N) x *55	Freewheeling Trim; Key unlocks Trim; Trim retracts latch/Trim relocks when key is removed		
Lever (E) x 59 x Lever (N) x *59	Freewheeling Trim; Key unlocks Trim; Trim retracts latch/Trim relocks when key is removed		
<b>MP9800 Electromechanical</b>			
Lever (E) x 01 x Lever (N) x *903	Blank Escutcheon Plate	\$2,186.00	\$2,263.00
Lever (E) x 01 x Lever (N) x *905	Blank Escutcheon Plate		
Lever (E) x 40 x Lever (N) x *903	No outside Operation (No Cylinder); Pull Only		
Lever (E) x 40 x Lever (N) x *905	No outside Operation (No Cylinder); Pull Only		
Lever (E) x 49 x Lever (N) x *903	Key unlocks Trim; Trim retracts latch; Trim relocks when key is removed		
Lever (E) x 49 x Lever (N) x *905	Key unlocks Trim; Trim retracts latch; Trim relocks when key is removed		
Lever (E) x 903 x Lever (N) x 10	Electrified Trim - Fail Safe	\$2,349.00	\$2,426.00
Lever (E) x 903 x Lever (N) x *45	Electrified Trim - Fail Safe		
Lever (E) x 905 x Lever (N) x 10	Electrified Trim - Fail Secure		
Lever (E) x 905 x Lever (N) x *45	Electrified Trim - Fail Secure		
Lever (E) x 905 x Lever (N) x *903	Electrified Trim - Fail Secure		
Lever (E) x 905 x Lever (N) x *905	Electrified Trim - Fail Secure		
Lever (E) x 903 x Lever (N) x *903	Electrified Trim - Fail Safe		
Lever (E) x 903 x Lever (N) x *905	Electrified Trim - Fail Safe		

\* Not recommended for use on any door used for Life Safety egress.

**MP9800 Series**  
Multi-Point Vertical Rod Lock

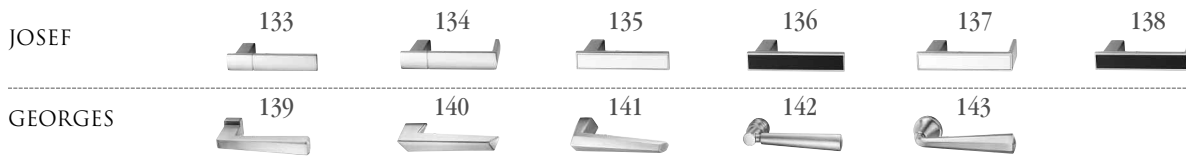

<b>MP9800A</b>		613E, 626	605 606 611 612 613 618 625
	<b>Josef, Georges Levers</b>		
Lever (E) x 01 x Lever (N) x *49	Blank Escutcheon Plate		
Lever (E) x 01 x Lever (N) x *45	Blank Escutcheon Plate		
Lever (E) x 01 x Lever (N) x 10	Blank Escutcheon Plate		
Lever (E) x 01 x Lever (N) x *55	Blank Escutcheon Plate		
Lever (E) x 01 x Lever (N) x 59	Blank Escutcheon Plate		
Lever (E) x 10 x Lever (N) x *49	Passage only (No cylinder)		
Lever (E) x 10 x Lever (N) x *45	Passage only (No cylinder)		
Lever (E) x 10 x Lever (N) x 10	Passage only (No cylinder)		
Lever (E) x 10 x Lever (N) x *55	Passage only (No cylinder)		
Lever (E) x 10 x Lever (N) x *59	Passage only (No cylinder)	\$2,189.00	\$2,266.00
Lever (E) x 40 x Lever (N) x *49	No outside Operation (No Cylinder); Pull Only		
Lever (E) x 40 x Lever (N) x *45	No outside Operation (No Cylinder); Pull Only		
Lever (E) x 40 x Lever (N) x 10	No outside Operation (No Cylinder); Pull Only		
Lever (E) x 45 x Lever (N) x *49	Class Room Key Outside Unlocks/locks Trim		
Lever (E) x 45 x Lever (N) x *45	Class Room Key Outside Unlocks/locks Trim		
Lever (E) x 45 x Lever (N) x 10	Class Room Key Outside Unlocks/locks Trim		
Lever (E) x 49 x Lever (N) x *10	Key unlocks Trim; Trim retracts latch; Trim relocks when key is removed		
Lever (E) x 49 x Lever (N) x *45	Key unlocks Trim; Trim retracts latch; Trim relocks when key is removed		
Lever (E) x 49 x Lever (N) x *49	Key unlocks Trim; Trim retracts latch; Trim relocks when key is removed		
<b>MP9800A Freewheeling Trim</b>			
Lever (E) x 50 x Lever (N) x *55	Freewheeling Trim; No Outside Operation		
Lever (E) x 50 x Lever (N) x *59	Freewheeling Trim; No Outside Operation		
Lever (E) x 52 x Lever (N) x 52	Key outside unlocks/locks O/S trim; Key inside unlocks/locks O/S trim		
Lever (E) x 55 x Lever (N) x *10	Freewheeling Trim; Key Outside Unlocks/locks Trim		
Lever (E) x 55 x Lever (N) x 50	Freewheeling Trim; Key Outside Unlocks/locks Trim		
Lever (E) x 55 x Lever (N) x *55	Freewheeling Trim; Key Outside Unlocks/locks Trim	\$2,189.00	\$2,266.00
Lever (E) x 55 x Lever (N) x *59	Freewheeling Trim; Key Outside Unlocks/locks Trim		
Lever (E) x 59 x Lever (N) x *10	Freewheeling Trim; Key unlocks Trim; Trim retracts latch/Trim relocks when key is removed		
Lever (E) x 59 x Lever (N) x 50	Freewheeling Trim; Key unlocks Trim; Trim retracts latch/Trim relocks when key is removed		
Lever (E) x 59 x Lever (N) x *55	Freewheeling Trim; Key unlocks Trim; Trim retracts latch/Trim relocks when key is removed		
Lever (E) x 59 x Lever (N) x *59	Freewheeling Trim; Key unlocks Trim; Trim retracts latch/Trim relocks when key is removed		
<b>MP9800A Electromechanical</b>			
Lever (E) x 01 x Lever (N) x *903	Blank Escutcheon Plate		
Lever (E) x 01 x Lever (N) x *905	Blank Escutcheon Plate		
Lever (E) x 40 x Lever (N) x *903	No outside Operation (No Cylinder); Pull Only		
Lever (E) x 40 x Lever (N) x *905	No outside Operation (No Cylinder); Pull Only		
Lever (E) x 49 x Lever (N) x *903	Key unlocks Trim; Trim retracts latch; Trim relocks when key is removed	\$2,349.00	\$2,426.00
Lever (E) x 49 x Lever (N) x *905	Key unlocks Trim; Trim retracts latch; Trim relocks when key is removed		
Lever (E) x 903 x Lever (N) x 10	Electrified Trim - Fail Safe		
Lever (E) x 903 x Lever (N) x *45	Electrified Trim - Fail Safe		
Lever (E) x 905 x Lever (N) x 10	Electrified Trim - Fail Secure		
Lever (E) x 905 x Lever (N) x *45	Electrified Trim - Fail Secure		
Lever (E) x 905 x Lever (N) x *903	Electrified Trim - Fail Secure		
Lever (E) x 905 x Lever (N) x *905	Electrified Trim - Fail Secure	\$2,512.00	\$2,589.00
Lever (E) x 903 x Lever (N) x *903	Electrified Trim - Fail Safe		
Lever (E) x 903 x Lever (N) x *905	Electrified Trim - Fail Safe		

\* Not recommended for use on any door used for Life Safety egress.

# MP9800 Series

## Multi-Point Vertical Rod Lock



*Cylinder Options	Specify	Add or Deduct
Conventional 6-pin	6P	Add \$83.00 per cylinder
Conventional 7-pin	7P	Add \$85.00 per cylinder
Pyramid Security fixed core	PS	Add \$138.00 per cylinder
Pyramid Security IC	PCS	Add \$197.00 per cylinder
Pyramid High Security fixed core	PHS	Add \$167.00 per cylinder
Pyramid High Security IC	PCHS	Add \$235.00 per cylinder
Pyramid IC with temporary construction core	CTP	Add \$154.00 per cylinder
Pyramid IC with temporary disposable core	CTPD	Add \$83.00 per cylinder
Pyramid IC less core	CLP	Add \$83.00 per cylinder
Security	HS	Add \$189.00 per cylinder
Security IC	CHS	Add \$259.00 per cylinder
Blockout function	BO	Add \$172.00 per cylinder
IC 6-pin	C6	Add \$154.00 per cylinder
IC 6-pin with temporary construction core(Red)	CT6R	Add \$154.00 per cylinder
IC 6-pin with temporary construction core(Blue)	CT6B	Add \$154.00 per cylinder
IC 6-pin with temporary construction core(Green)	CT6G	Add \$154.00 per cylinder
IC 6-pin with temporary disposable core	CT6D	Add \$83.00 per cylinder
IC 6-pin less core	CL6	Add \$83.00 per cylinder
SFIC 6-pin with Less Core	CLS6	Add \$83.00 per cylinder
IC 6-pin with SFIC disposable temporary core	CT6SD	Add \$83.00 per cylinder
IC 7-pin	C7	Add \$158.00 per cylinder
IC 7-pin with temporary construction core(Red)	CT7R	Add \$158.00 per cylinder
IC 7-pin with temporary construction core(Blue)	CT7B	Add \$158.00 per cylinder
IC 7-pin with temporary construction core(Green)	CT7G	Add \$158.00 per cylinder
IC 7-pin with temporary disposable core	CT7D	Add \$85.00 per cylinder
IC 7-pin less core	CL7	Add \$85.00 per cylinder
SFIC 7-pin with Less Core	CLS7	Add \$85.00 per cylinder
IC 7-pin with SFIC disposable temporary core	CTS7SD	Add \$85.00 per cylinder
*Keying Options	Specify Quick Code	Add or Deduct
O-Bitted with 2 blank keys	STDKEY	No Charge
Keyed random	KR Specify Keyset	No Charge
Master keyed (all cylinders except 8000, 8020, 8027 IC core)	MK	Add \$16.00 per cylinder
Master keyed Pyramid	MK	Add \$16.00 per cylinder
Master keyed Security (including IC cylinder and core)	MK	Add \$16.00 per cylinder
Master keyed (8000, 8020, 8027 IC core)	MK-IC	No Charge
Master keyed to customer bittings or sample key	MK-CB	Add \$16.00 per cylinder
Construction master keyed	CMK	Add \$16.00 per cylinder
No Stamping	VKCO	\$4.50
Keys only	VKC1	No Charge
Cylinders and Keys	VKC2	\$8.00
Cylinders only	VKC3	\$8.00
CKC cylinders with VKC keys	CKC2	\$8.00
CKC cylinders only	CKC3	\$8.00

Copyright © 2002 - 2017 Corbin Russwin, Inc.

# MP9800 Series

## Multi-Point Vertical Rod Lock



Door Height Options	Specify	Add or Deduct
7'0"	Standard	No Charge
7'2"	H702	
7'6"	H706	
8'0"	H0800	
9'0"	H0900	
10'0"	H1000	
Door Thickness	Specify	Add or Deduct
1-3/4" (44mm)	Standard	No Charge
2" (51mm)	D200	No Charge
2-1/4" (57mm)	D214	No Charge
Motorized Electric Latch Retraction	Specify	Add or Deduct
Electric Latch Retraction	MELR	Add \$835.00 per device

# MP9800 Series

## Multi-Point Vertical Rod Lock



Miscellaneous Options	Specify	Add or Deduct
Spanner Head Screw	M02	Add \$32.00 per device
Torx® head screws	M04	Add \$42.00 per device
Knurling outside and inside	M20	Add \$139.00 per device
Knurling outside only	M21	Add \$65.00 per device
Knurling inside only	M22	Add \$74.00 per device
Abrasive coat outside and inside (trim and device)	M23	Add \$88.00 per device
Abrasive coat inside only (device side)	M24	Add \$46.00 per device
Abrasive coat outside only (trim side)	M25	Add \$42.00 per device
Less bottom vertical rod	M55	No Charge
Latchbolt Monitoring	M91	Add \$217.00 per device
O/S Lever Monitoring	M93	Add \$204.00 per device
I/S Lever Monitoring	M92	Add \$204.00 per device
Windstorm	M107	Add \$115.00 per device
Aluminum Door	MPAD	No Charge
Rectangular Back Plate (Required for Wood Door - MPWD)	MPER	
Back Plate (Required for Wood Door - MPWD)	MPES	
Lever Hold Back	MPHB	Add \$20.00 per device
Fire Rated Wood Door	MPWD	No Charge
aux control (classroom)	AUX155	Add \$582.00 per device
aux control (storeroom)	AUX159	Add \$582.00 per device
MicroShield® Antimicrobial finish coating	626C	Add \$62.00 (Exit Devices & Trims (ordered separately) Add \$76.00 (Exit Devices & Outside Trims (ordered together)
MicroShield® Antimicrobial finish coating	630C	Add \$62.00 (Exit Devices & Trims (ordered separately) Add \$76.00 (Exit Devices & Outside Trims (ordered together)





Look for the   
MicroShield icon.

ED3000  
ED4000  
ED5000  
ED7000

**MicroShield®**

As part of their promise to provide innovative solutions to their customers, certain ASSA ABLOY Group brands offer the MicroShield® technology, a silver-based antimicrobial coating designed to inhibit the growth of bacteria.

MicroShield® is a registered trademark of Yale Security Inc., an ASSA ABLOY Group company.

Product	Series	MicroShield® Coated Components
Exit Devices	ED4000 and ED5000 Series	Inside rail, push rail, head cover, end cap* Outside trim: levers/pull* and escutcheons
	ED3000 and ED7000 Series	Active/Inactive case covers, cross bar, arms Outside trim: levers/pull* and escutcheons

**AVAILABLE FINISHES**

- MicroShield® is available on 626 and 630. Other finishes available by Special Product Application Request Form only.
- Specify 626C (satin chrome plated) or 630C (satin stainless steel) when ordering.
- MicroShield® coating will be applied over 626 and 630 finishes. All components will match 626.

*Note: MicroShield® coating will only be applied to “high touch” components.*

**HOW TO ORDER**

Product	How to Order
Exit Devices & Outside Trims (ordered together)	ED5200 x C955 x 630C x LHR
Exit Devices & Trims (ordered separately)	N955 x 630C x RHR

Description	Add
Exit Devices & Outside Trims (ordered together)	Add \$76.00 (when ordered together)
Exit Devices & Trims (ordered separately)	Add \$62.00

A large empty rectangular box with a thin black border, intended for handwritten notes.

**Standard Features**

**Handing**

Handed, specify hand

**Door Thickness**

1-3/4"

**Backset**

2-3/4"

**Projection**

5-3/4"; 4-1/2" depressed

**Trim**

Cylinder is not included.  
See page 246 for  
cylinder options.

**Rim**

ED3200  
ED3200A

Panic  
3 Hour Fire Rated

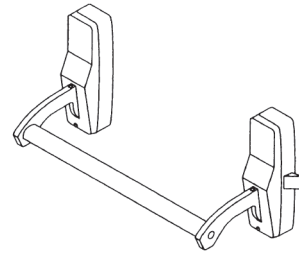

**Surface Vertical Rod**

ED3400    Panic  
ED3400A    3 Hour Fire Rated

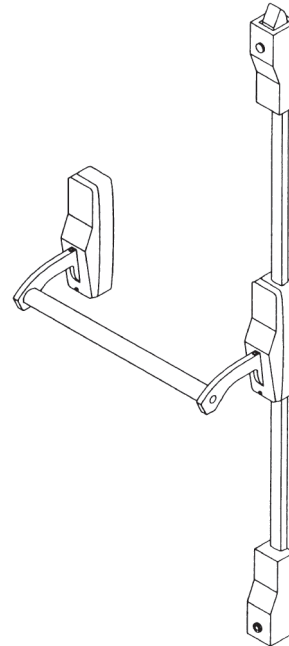

**Mortise**

ED3600    Panic  
ED3600A    3 Hour Fire Rated

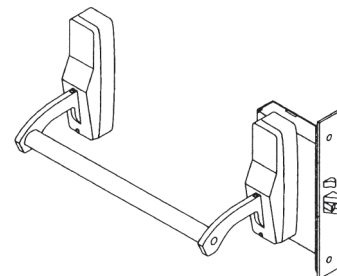

**Ordering Examples**

**Rim Exit Device**

Quantity	Exit Device	Finish	Hand	Misc. Options
20	ED3250	630	RHR	M51-M54

**Rim Exit Device with Trim**

Quantity	Exit Device	Trim	Finish	Hand	Door Thickness	Door Width	Misc. Options
50	ED3255A	A3355	630	RHR	D200	W048	M53

**Trim Only (Rim Exit Device or Vertical Rod)**

Quantity	Exit Device	Finish	Hand
10	L3310	606	RHR

**Surface Vertical Rod Exit Device with Trim**

Quantity	Exit Device	Trim	Finish	Hand	Door Thickness	Door Width	Misc. Options
50	ED3410	R3310	606	RHR	D214	W048	H1000

**Mortise Exit Device with Trim**

Quantity	Exit Device	Trim	Finish	Hand	Door Thickness	Strike	Door Width
50	ED3657	L3357	630	LHR	D200	SB200	W048

**Contract/Detailed Order - Rim Exit Device with Trim**

Quantity	Keyset	Exit Device	Trim	Finish	Hand	Door Thickness	Door Width	Optional Cylinders	Keying
50	AA1	ED3255	N3355	630	LHR	D200	W048	C6	VKC3

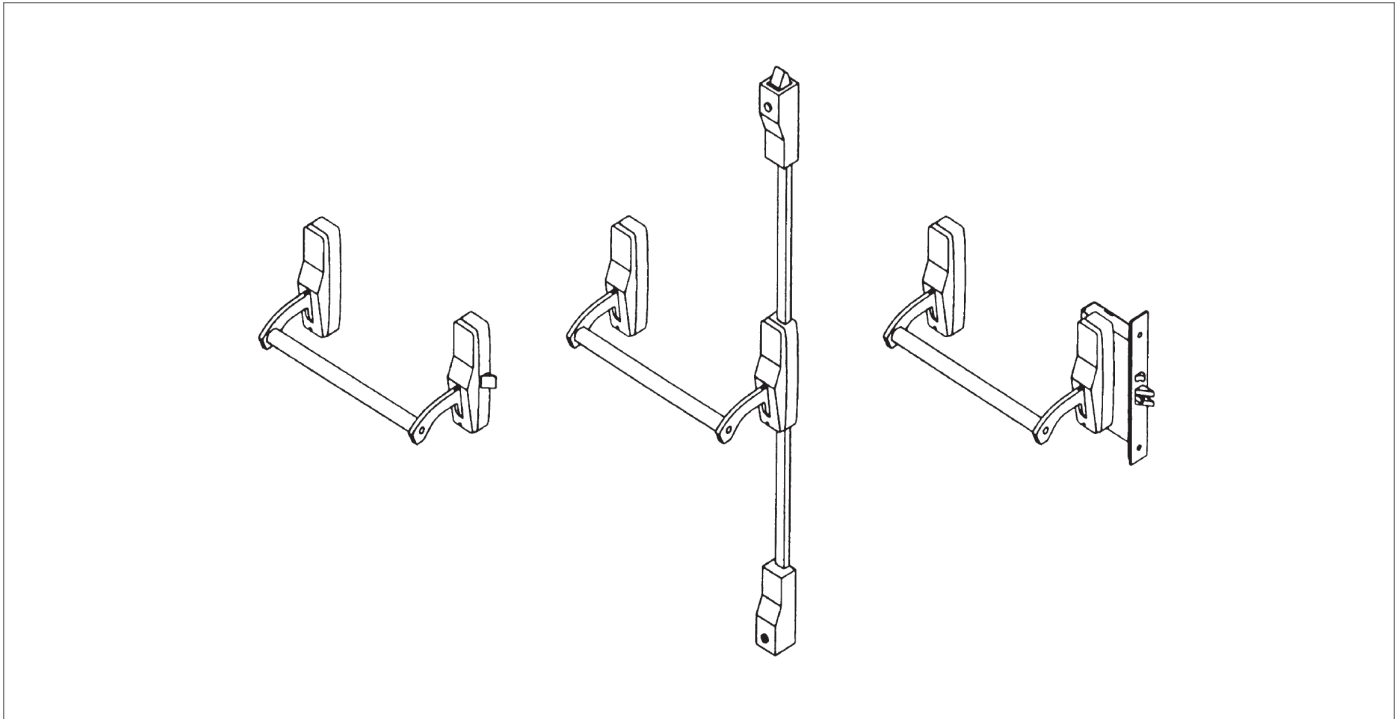

**36" Device Only**

Includes device, strike(s) and screw pack. No cylinder or trim.

**Rim ED3200 Series**

Function	Description	Finish: 613E	Finish: 605, 606, 611, 612, 613, 629, 630
ED3210	Panic device only (Passage)	\$1,749.00	\$1,919.00
ED3250	Panic device only (Dummy)		
ED3255	Panic (Classroom)		
ED3257	Panic (Nightlatch)		
ED3210T	Thumb Piece (Passage)		
ED3255T	Thumb Piece (Classroom)	\$1,912.00	\$2,082.00
ED3210A	3 Hour Fire Rated (Passage)		
ED3250A	3 Hour Fire Rated (Dummy)		
ED3255A	3 Hour Fire Rated (Classroom)		
ED3257A	3 Hour Fire Rated (Nightlatch)		
ED3210AT	Thumb Piece – 3 Hour Fire Rated (Passage)		
ED3255AT	Thumb Piece – 3 Hour Fire Rated (Classroom)		

For rim and surface vertical rod exit trim prices, see pages 269-272.

For fire rated rim exit trim prices, see pages 273-276.

For mortise exit device trim prices see pages 277-280.

**Caution:** Be sure of your measurements. Exit devices are NOT returnable.

Notes:

For doors over 1-3/4" thick, a Special Application Request must be submitted to the factory prior to approval and pricing.

**Surface Vertical Rod ED3400 Series**

Function	Description	Finish: 613E	Finish: 605, 606, 611, 612, 613, 629, 630
ED3410	Panic (Passage)	\$2,254.00	\$2,424.00
ED3450	Panic (Dummy)		
ED3455	Panic (Classroom)		
ED3457	Panic (Nightlatch)		
ED3410T	Thumb Piece (Passage)		
ED3455T	Thumb Piece (Classroom)		
ED3410A	3 Hour fire rated (Passage)	\$2,417.00	\$2,587.00
ED3450A	3 Hour fire rated (Dummy)		
ED3455A	3 Hour Fire Rated (Classroom)		
ED3457A	3 Hour Fire Rated (Nightlatch)		
ED3410AT	Thumb Piece – 3 Hour Fire Rated (Passage)		
ED3455AT	Thumb Piece – 3 Hour Fire Rated (Classroom)		

**Mortise ED3600 Series**

Function	Description	Finish: 613E	Finish: 605, 606, 611, 612, 613, 629, 630
ED3610	Panic (Passage)	\$2,029.00	\$2,199.00
ED3650	Panic (Dummy)		
ED3655	Panic (Classroom)		
ED3657	Panic (Nightlatch)		
ED3610T	Thumb Piece (Passage)		
ED3655T	Thumb Piece (Classroom)		
ED3610A	3 Hour fire rated (Passage)		
ED3650A	3 Hour fire rated (Dummy)		
ED3655A	3 Hour Fire Rated (Classroom)		
ED3657A	3 Hour Fire Rated (Nightlatch)		
ED3610AT	Thumb Piece – 3 Hour Fire Rated (Passage)		
ED3655AT	Thumb Piece – 3 Hour Fire Rated (Classroom)		

For rim and surface vertical rod exit trim prices, see pages 269-272.

For fire rated rim exit trim prices, see pages 273-276.

For mortise exit device trim prices see pages 277-280.

**Caution:** Be sure of your measurements. Exit devices are NOT returnable.

Notes:

For doors over 1-3/4" thick, a Special Application Request must be submitted to the factory prior to approval and pricing.

**ED3200/ED3200A/ED3400/ED3400A/ED3600/ED3600A Rim, Surface Vertical Rod, and Mortise Trim**

Cylinder is not included.

**Escutcheon Trim Design: A33 Armstrong**



**Lever:** Cast    **Escutcheon:** Cast

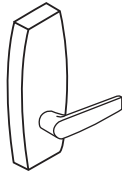

Function	Description	Finish: 613E, 626	Finish: 605, 606, 611, 612, 613, 618, 619, 625
A3310	Passage	\$499.00	\$535.00
A3350	Dummy		
A3355	Classroom		
A3357	Nightlatch – Rim		
A33V57	Nightlatch – SVR		
A33M57	Nightlatch – Mortise		

**Escutcheon Trim Design: C33 Citation**



**Lever:** Cast    **Escutcheon:** Cast

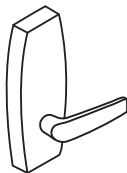

Function	Description	Finish: 613E, 626	Finish: 605, 606, 611, 612, 613, 618, 619, 625
C3310	Passage	\$499.00	\$535.00
C3350	Dummy		
C3355	Classroom		
C3357	Nightlatch – Rim		
C33V57	Nightlatch – SVR		
C33M57	Nightlatch – Mortise		

**Escutcheon Trim Design: D33 Dirke**



**Lever:** Cast    **Escutcheon:** Cast

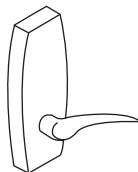

Function	Description	Finish: 613E, 626	Finish: 605, 606, 611, 612, 613, 618, 619, 625
D3310	Passage	\$499.00	\$535.00
D3350	Dummy		
D3355	Classroom		
D3357	Nightlatch – Rim		
D33V57	Nightlatch – SVR		
D33M57	Nightlatch – Mortise		

**Escutcheon Trim Design: L33 Lustra**



**Lever:** Cast    **Escutcheon:** Cast

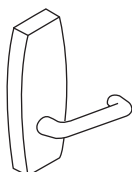

Function	Description	Finish: 613E, 626	Finish: 605, 606, 611, 612, 613, 618, 619, 625
L3310	Passage	\$499.00	\$535.00
L3350	Dummy		
L3355	Classroom		
L3357	Nightlatch – Rim		
L33V57	Nightlatch – SVR		
L33M57	Nightlatch – Mortise		

**ED3200/ED3200A/ED3400/ED3400A/ED3600/ED3600A Rim, Surface Vertical Rod, and Mortise Trim**

Cylinder is not included.

**Escutcheon Trim Design: N33 Newport**



**Lever:** Cast    **Escutcheon:** Cast

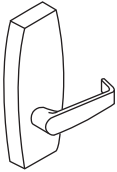

Function	Description	Finish: 613E, 626	Finish: 605, 606, 611, 612, 613, 618, 619, 625
N3310	Passage	\$499.00	\$535.00
N3350	Dummy		
N3355	Classroom		
N3357	Nightlatch – Rim		
N33V57	Nightlatch – SVR		
N33M57	Nightlatch – Mortise		

**Escutcheon Trim Design: PR33 Princeton**



**Lever:** Cast    **Escutcheon:** Cast



Function	Description	Finish: 613E, 626	Finish: 605, 606, 611, 612, 613, 618, 619, 625
PR3310	Passage	\$499.00	\$535.00
PR3350	Dummy		
PR3355	Classroom		
PR3357	Nightlatch – Rim		
PR33V57	Nightlatch – SVR		
PR33M57	Nightlatch – Mortise		

**Escutcheon Trim Design: R33 Regis**



**Lever:** Cast    **Escutcheon:** Cast

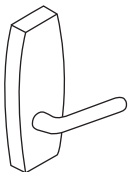

Function	Description	Finish: 613E, 626	Finish: 605, 606, 611, 612, 613, 618, 619, 625
R3310	Passage	\$499.00	\$535.00
R3350	Dummy		
R3355	Classroom		
R3357	Nightlatch – Rim		
R33V57	Nightlatch – SVR		
R33M57	Nightlatch – Mortise		



**ED3200/ED3200A/ED3400/ED3400A/ED3600/ED3600A Rim, Surface Vertical Rod, and Mortise Trim**

Cylinder is not included.

**Escutcheon Trim Design: T33 D Grip**

**Grip:** Extruded **Escutcheon:** Wrought



Function	Description	Finish: 613E, 626	Finish: 605, 606, 611, 612, 613, 618, 619, 625, 629, 630
T3310	Passage	\$326.00	\$354.00
T3350	Dummy		
T3355	Classroom		
T3357	Nightlatch – Rim		
T33M55	Classroom – Mortise		
T33M57	Nightlatch – Mortise		

**Escutcheon Trim Design: T34 Round Grip**

**Grip:** Extruded **Escutcheon:** Wrought



Function	Description	Finish: 613E, 626	Finish: 605, 606, 611, 612, 613, 618, 619, 625
T3410	Passage	\$326.00	\$354.00
T3450	Dummy		
T3455	Classroom		
T3457	Nightlatch – Rim		
T34M55	Classroom – Mortise		
T34M57	Nightlatch – Mortise		

**Escutcheon Trim Design: T35 Sectional Grip**

**Grip:** Extruded



Function	Description	Finish: 613E, 626	Finish: 605, 606, 611, 612, 613, 618, 619, 625, 629, 630
T3510	Passage	\$356.00	\$386.00
T3550	Dummy		
T3555	Classroom		
T3557	Nightlatch – Rim		
T35M55	Classroom – Mortise		
T35M57	Nightlatch – Mortise		

**Auxiliary Control/Inside Lever Assembly: 3357T Nightlatch**

Auxiliary Control



Function	Description	Finish: 613E, 626	Finish: 605, 606, 611, 612, 613, 618, 619, 625, 629, 630
3357T	Auxiliary Control/Inside Lever Assembly	\$652.00	\$688.00

Inside Lever Assembly



**Offset Pull Trim: P12, P13, P14**

Offset Pull Trim	Part Number	Finish: 613E, 630	Finishes: 605, 606, 612, 613, 626, 629
P12	716F50M X Finish	\$258.00	\$272.00
P13	716F51M X Finish	\$316.00	\$330.00
P14	716F52M X Finish	\$223.00	\$237.00

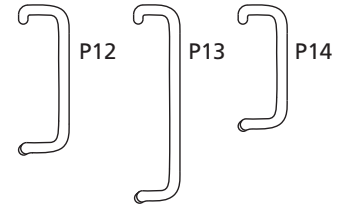
**Cylinder Options**

Description	Specify	Add or Deduct
Conventional 6-pin	6P*	Add \$83.00 per cylinder
Conventional 7-pin	7P	Add \$85.00 per cylinder
Access 3 Patented	AP	Add \$83.00 per cylinder
Access 3 Security	AS	Add \$132.00 per cylinder
Access 3 High Security, UL 437	AHS	Add \$152.00 per cylinder
Access 3 IC Patented	ACP	Add \$154.00 per cylinder
Access 3 IC Security	ACS	Add \$203.00 per cylinder
Access 3 IC High Security, UL 437	ACHS	Add \$223.00 per cylinder
Pyramid Security fixed core	PS	Add \$138.00 per cylinder
Pyramid Security IC	PCS	Add \$197.00 per cylinder
Pyramid High Security fixed core	PHS	Add \$167.00 per cylinder
Pyramid High Security IC	PCHS	Add \$235.00 per cylinder
Pyramid IC with temporary construction core	CTP	Add \$154.00 per cylinder
Pyramid IC with temporary disposable core	CTPD	Add \$83.00 per cylinder
Pyramid IC less core	CLP	Add \$83.00 per cylinder
Security	HS	Add \$189.00 per cylinder
Security IC	CHS	Add \$259.00 per cylinder
Blockout function cylinder	BO	Add \$172.00 per cylinder
IC 6-pin	C6	Add \$154.00 per cylinder
IC 6-pin with temporary construction core (Red)	CT6R	Add \$154.00 per cylinder
IC 6-pin with temporary construction core (Blue)	CT6B	Add \$154.00 per cylinder
IC 6-pin with temporary construction core (Green)	CT6G	Add \$154.00 per cylinder
IC 6-pin with temporary disposable core	CT6D	Add \$83.00 per cylinder
IC 6-pin less core	CL6	Add \$83.00 per cylinder
SFIC 6-pin with Less Core	CLS6	Add \$83.00 per cylinder
IC 6-pin with SFIC disposable temporary core	CT6SD	Add \$83.00 per cylinder
IC 7-pin	C7**	Add \$158.00 per cylinder
IC 7-pin with temporary construction core (Red)	CT7R**	Add \$158.00 per cylinder
IC 7-pin with temporary construction core (Blue)	CT7B**	Add \$158.00 per cylinder
IC 7-pin with temporary construction core (Green)	CT7G**	Add \$158.00 per cylinder
IC 7-pin with temporary disposable core	CT7D**	Add \$85.00 per cylinder
IC 7-pin less core	CL7**	Add \$85.00 per cylinder
SFIC 7-pin with Less Core	CLS7**	Add \$85.00 per cylinder
IC 7-pin with SFIC disposable temporary core	CT7SD**	Add \$85.00 per cylinder

\*6P cylinder option is supplied in 6-pin, L4 keyway 0-bitted with two nickel silver keys.

IC 6-pin with temporary construction core CT6.

IC 7-pin with temporary construction core CT7.

\*\*Not available with Rim or SVR Lever Trim – Classroom Function.  
or SVR Lever Trim – Night Latch Function.

**Keying Options**

Description	Specify	Add or Deduct
0-Bitted with 2 blank keys	(standard)	No Charge
Keyed random	KR	No Charge
Construction master keyed <sup>1,2</sup>	CMK	Add \$16.00 per cylinder
Visual key control (VKC)		
- No Stamping	VKC0	\$4.50
- Keys only	VKC1	No Charge
- Cylinders and Keys <sup>3</sup>	VKC2	\$8.00
- Cylinders only <sup>3</sup>	VKC3	\$8.00
Concealed key control (CKC)		
- CKC cylinders with VKC keys	CKC2	\$8.00
- CKC cylinders only <sup>3</sup>	CKC3	\$8.00
More than 2 keys per lock	KY# (e.g., KY6)	See page 66 - Cut Keys Section

**Notes:**

1. CMK Construction master keying charge is in addition to master keying charge.
2. CMK Construction master keying is not available in Pyramid or Security series.
3. VKC2, VKC3, CKC3 are not available in Pyramid or Security series.

**Custom Laser Engraving- LASER**
**Laser engraving processing charge (all engraving types)**

- \$250 net per order. Charge will be applied to production order when placed.

**Single Vanity, Logo or Other (same engraving on all parts)**

- Lever - \$10 net add each
- Mortise Escutcheon - \$10 net add each
- HPSK Paddle - \$10 net add each

**Unique laser engraving (i.e. Room Number, Apartment Number, etc)**

- \$12 net add each (per piece)

**Strike Options**

To purchase strike separately see catalog for part no.

Description	Specify Quick Code	Add or Deduct
Fire rated rim strike on ED3200	(standard)	No Charge
Mortised adjustable rim strike	S04	
Rim x vertical rod strike for pairs of doors	S02	Add \$26.00 to device
Vertical rod flush bottom strike (ED3400 only)	S03	No Charge
Vertical rod surface projecting bottom strike on ED3400 device	(standard)	
Fire rated vertical rod bottom strike on ED3400A device	(standard)	
Fire rated vertical rod bottom strike for threshold	S06	

Description	Door Thickness	Specify	Add or Deduct
Curved lip ANSI strike	1-3/4"	SA114 (standard)	No Charge
	2"	SA138	
	2-1/4"	SA158	

Description	Door Thickness	Specify	Add or Deduct
Mortise straight lip ANSI strike on ED3600, ED3600A	1-3/4"	SS118	No Charge
	2"	SS138	
	2-1/4"	SS158	

Description	Door Thickness	Specify	Add or Deduct
Mortise open back strike	1-3/4"	SB134	Add \$80.00 per device
	2"	SB200	\$128.00
	2-1/4"	SB214	\$128.00

**Miscellaneous Options**

Description	Specify	Add or Deduct
Spanner head screws	M02	Add \$32.00 per device
Torx® screws for rim, mortise	M04	Add \$42.00 per device
Torx® screws for surface vertical rod		Add \$80 per device
Abrasive coat outside and inside (trim and device)	M23	Add \$88.00 per device
Abrasive coat inside only (device side)	M24	Add \$46.00 per device
Abrasive coat outside only (trim side)	M25	Add \$42.00 per device
Steel reinforced crossbar	M53	Add \$68.00 per device
Sex nuts and bolts (SNBs)	M54	No Charge
Mullion stabilizer	M57	Add \$62.00 per mullion
Shim for 2-3/4" backset on doors with 1/2" stop (rim devices only)	M59	No Charge
Flush transom bracket	M67	Add \$30.00 per device

**Door Width Options**

Description	Specify	Add or Deduct
36"	(standard)	No Charge
48"	W048	Add \$35.00 per device

**Door Thickness Options**

Description	Specify	Add or Deduct
1-3/4"	(standard)	No Charge
2"	D200	
2-1/4"	D214	

**Door Height Options**

Description	Specify	Add or Deduct
7'0" H0700	H0700	No Charge
7'2" H0702	H0702	
7'6" H0706	H0706	
8' (Standard)	(standard)	
8'6" H0806 (ED3400 device only)	H0806	Add \$82.00 per device
9' H0900 (ED3400 device only)	H0900	
10' H01000 (ED3400 device only)	H01000	

**Mullions**

Cylinder not included

**Ordering Example**

Quantity	Mullion Number
10	507

**Removable Mullion**

Description	Specify	Price
Up to 7'0" Steel Mullion - Panic Rated	907	\$636.00
Up to 8'0" Steel Mullion - Panic Rated	908	\$646.00
Up to 10'0" (ED3200 only), Steel Mullion - Panic Rated	910	\$766.00
Up to 7'0", Steel Mullion - 3 Hour Fire Rated	907A	\$883.00
Up to 8'0", Steel Mullion - 3 Hour Fire Rated	908A	\$893.00

**Key Removable Mullion**

Description	Specify	Price
Up to 7'0", key removable mullion, 1-1/2 Hour Fire Rated	907BKM <sup>1</sup>	\$1,360.00
Up to 8'0", key removable mullion, 1-1/2 Hour Fire Rated	908BKM <sup>1</sup>	\$1,370.00
Up to 10'0" (ED3200 only), key removable mullion, Panic Rated	910KM <sup>1</sup>	\$1,202.00
Door frame filler block for double rabbetted frames	M95	Add \$42.00 per mullion
Door frame angle bracket for aluminum frames	M96	Add \$42.00 per mullion

Note 1: Cylinder and collars not included, specify separately

**Mullions Cylinder Options**

Description	Specify	Add or Deduct
Conventional 6-pin	6P	Add \$83.00 per cylinder
Conventional 7-pin	7P	Add \$85.00 per cylinder
IC 6-pin	C6	Add \$154.00 per cylinder
IC 7-pin	C7	Add \$158.00 per cylinder
Pyramid High Security Fixed Core	PHS	Add \$167.00 per cylinder
Pyramid Security Fixed Core	PS	Add \$138.00 per cylinder
Pyramid High Security IC	PCHS	Add \$235.00 per cylinder
Pyramid Security IC	PCS	Add \$197.00 per cylinder
Security	HS	Add \$189.00 per cylinder
Security IC	CHS	Add \$259.00 per cylinder
IC 6-pin less core	CL6	Add \$83.00 per cylinder
IC 7-pin less core	CL7	Add \$85.00 per cylinder

**Mortise Lock Only**

Lock Number	Description	Finish: 605, 606, 611, 612, 613, 613E, 625, 626
MLE012	Lockbody for Nightlatch/Dummy function	\$583.00
MLE013	Lockbody for Classroom function	
MLE014	Lockbody for Passage function	
MLE015	Lockbody for Passage Thumbpiece function	
MLE016	Lockbody for Classroom Thumbpiece function	

**Ordering Example**
**Mortise Lock Only**

Quantity	Lock Number	Finish	Hand
2	MLE013	630	LHR



The PathLite™ patent pending technology offers a number of benefits:

- Requires no wiring or maintenance
- Recharges with exposure to ambient light
- Unaffected by heat or cold
- Non-toxic, will not rub or fade
- Vandal resistant
- Fire resistant and non-radioactive
- Green contrasting word "EXIT" centered on touchbar in 1-1/4" high lettering
- Cost effective; especially suited for existing buildings

PathLite™ photoluminescent exit devices meet New York City's newly adopted standards for requirement of photoluminescent signage and stairwell markings in all office buildings in excess of 75 feet in height.

**How To Order Complete Device**

Exit Device	Trim/Function	Finish	Hand	Misc. Options
ED4200	A810	630	RHR	M49

ED4200 x A810 x 630 x RHR x M49

Options	Specify	Price
24" , 36" , and 48" PathLite™ Photoluminescent Touchbar Cover	M49	Add: \$348.00

**How to Order Touchbar Cover Only**

Options	Part Number	Price
24" PathLite™ Photoluminescent Touchbar cover	710F797	\$374.00
36" PathLite™ Photoluminescent Touchbar cover	710F737	
48" PathLite™ Photoluminescent Touchbar cover	710F747	

**Standard Features**

**Handing**

Devices are field reversible; specify hand. Lever trims are handed; specify hand

**Door Thickness**

1-3/4"

Product	Minimum Stile
ED4200S	2"
ED4200SM	3 1/2"
ED4200SMA	3 1/2"
ED4200	2"
ED4200M	3 1/2"
ED4200MA	3 1/2"
ED4400	2"
ED4400M	3 1/2"
ED4400MA	3 1/2"
ED4800	2"
ED4800M	3 1/2"
ED4800MA	3 1/2"

**Projection**

3-1/4"; 2-3/4" dogged

**Trim**

Cylinder is not included. See page 236 for cylinder options

**Door Width**

36"

**SecureBolt®**

ED4200S      Panic  
 ED4200SM    Panic  
 ED4200SMA   3 Hour Fire Rated

**Rim**

ED4200      Panic  
 ED4200M    Panic  
 ED4200MA   3 Hour Fire Rated

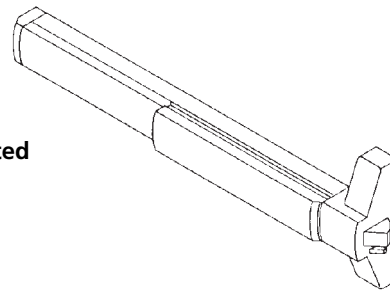

**Surface Vertical Rod**

ED4400      Panic  
 ED4400M    Panic  
 ED4400MA   3 Hour Fire Rated

**Concealed Vertical Rod**

ED4800      Panic  
 ED4800M    Panic  
 ED4800MA   3 Hour Fire Rated

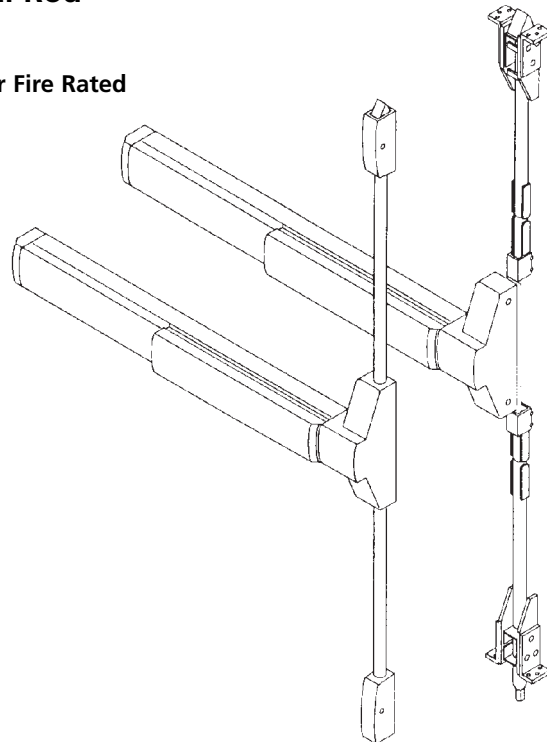



**Ordering Example**
**Exit Device Only**

Quantity	Exit Device	Finish	Hand	Misc. Options
20	ED4200	606	RHR	M51-M54

**Removable Mullions**

Quantity	Mullion	Finish	Misc. Options
12	808	695	M57

**Exit Device with Trim**

Quantity	Exit Device	Trim/Function	Finish	Hand	Door Thickness	Door Width	Door Height	Misc. Options
10	ED4400	N855	605	LHR	D200	W048	H0706	M51-M54

**Trim Only**

Quantity	Trim/Function	Finish	Hand	Door Thickness
24	N855	625	RHR	D214

**Contract/Detailed Order - Rim Exit Device with Trim**

Quantity	Keypad	Exit Device	Trim/Function	Finish	Hand	Door Height	Optional Strike	Door Width	Misc. Options	Optional Cylinder
36	AA1	ED4400	C855	626	LHR	H0800	S09	W048	M52-M54	7P

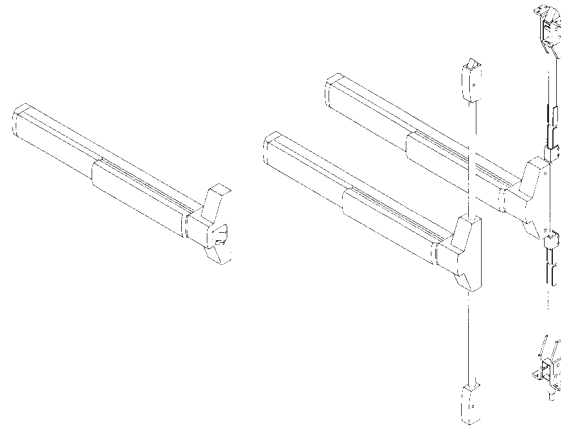

**36" Device Only, See Quick Code section for 24" and 48" door width options**

Includes device, strike(s) and screw pack. No cylinder or trim.

**SecureBolt® ED4200S Series**

Function	Description	Finish: 613E, 630*	Finish: 605, 606, 611, 612, 613, 618, 619, 625, 629, 722
ED4200S	Panic	\$1,955.00	\$2,035.00
ED4200SM	Panic	\$1,955.00	\$2,035.00
ED4200SMA	3 Hour Fire Rated	\$2,118.00	\$2,198.00

**Rim ED4200 Series**

Function	Description	Finish: 613E, 630*	Finish: 605, 606, 611, 612, 613, 618, 619, 625, 629, 722
ED4200	Panic	\$1,887.00	\$1,967.00
ED4200M	Panic	\$1,887.00	\$1,967.00
ED4200MA	3 Hour Fire Rated	\$2,050.00	\$2,130.00

**Vertical Rod ED4400 Series**

Function	Description	Finish: 613E, 630*	Finish: 605, 606, 611, 612, 613, 618, 619, 625, 629, 722
ED4400	Panic	\$2,197.00	\$2,277.00
ED4400M	Panic	\$2,197.00	\$2,277.00
ED4400MA	3 Hour Fire Rated	\$2,360.00	\$2,440.00

**Concealed V.R. ED4800 Series**

Function	Description	Finish: 613E, 630*	Finish: 605, 606, 611, 612, 613, 618, 619, 625, 629, 722
ED4800	Panic	\$2,458.00	\$2,538.00
ED4800M	Panic	\$2,458.00	\$2,538.00
ED4800MA	3 Hour Fire Rated	\$2,621.00	\$2,701.00

For rim, surface and concealed vertical rod exit trim prices, see pages 235-238.

Caution: Be sure of your measurements. Exit devices are NOT returnable.

\* Contact factory for 626 finish availability.

**ED4200S/ED4200/ED4400/ED4800 SecureBolt®, Rim, Surface and Concealed V.R. Trim**

Cylinder is not included.

**Escutcheon Trim Design: A8 Armstrong**



**Lever:** Cast

**Escutcheon:** Wrought

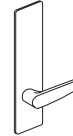

Function	Description	Finish: 613E, 630	Finish: 605, 606, 611, 612, 613, 618, 619, 625, 626, 629, 722
A810	Passage	\$588.00	\$614.00
A850	Dummy		
A855	Classroom <sup>1</sup>		
A859	Storeroom		

**Escutcheon Trim Design: C8 Citation**



**Lever:** Cast

**Escutcheon:** Wrought

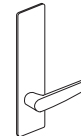

Function	Description	Finish: 613E, 630	Finish: 605, 606, 611, 612, 613, 618, 619, 625, 626, 629, 722
C810	Passage	\$588.00	\$614.00
C850	Dummy		
C855	Classroom <sup>1</sup>		
C859	Storeroom		

**Escutcheon Trim Design: D8 Dirke**



**Lever:** Cast

**Escutcheon:** Wrought



Function	Description	Finish: 613E, 630	Finish: 605, 606, 611, 612, 613, 618, 619, 625, 626, 629, 722
D810	Passage	\$588.00	\$614.00
D850	Dummy		
D855	Classroom <sup>1</sup>		
D859	Storeroom		

Note:

1. Classroom function trim may be converted to storeroom function by a simple field adjustment. No additional parts required.

**ED4200S/ED4200/ED4400/ED4800 SecureBolt®, Rim, Surface and Concealed V.R. Trim**

Cylinder is not included.

**Escutcheon Trim Design: E8 Essex**



**Lever:** Cast

**Escutcheon:** Wrought

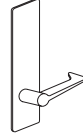

Function	Description	Finish: 613E, 630	Finish: 605, 606, 611, 612, 613, 618, 619, 625, 626, 629, 722
E810	Passage	\$588.00	\$614.00
E850	Dummy		
E855	Classroom <sup>1</sup>		
E859	Storeroom		

**Escutcheon Trim Design: L8 Lustra**



**Lever:** Cast

**Escutcheon:** Wrought

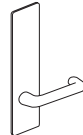

Function	Description	Finish: 613E, 630	Finish: 605, 606, 611, 612, 613, 618, 619, 625, 626, 629, 722
L810	Passage	\$588.00	\$614.00
L850	Dummy		
L855	Classroom <sup>1</sup>		
L859	Storeroom		

**Escutcheon Trim Design: N8 Newport**



**Lever:** Cast

**Escutcheon:** Wrought

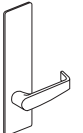

Function	Description	Finish: 613E, 630	Finish: 605, 606, 611, 612, 613, 618, 619, 625, 626, 629, 722
N810	Passage	\$588.00	\$614.00
N850	Dummy		
N855	Classroom <sup>1</sup>		
N859	Storeroom		

**Escutcheon Trim Design: R8 Regis**



**Lever:** Cast

**Escutcheon:** Wrought

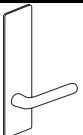

Function	Description	Finish: 613E, 630	Finish: 605, 606, 611, 612, 613, 618, 619, 625, 626, 629, 722
R810	Passage	\$588.00	\$614.00
R850	Dummy		
R855	Classroom <sup>1</sup>		
R859	Storeroom		

Note:  
1. Classroom function trim may be converted to storeroom function by a simple field adjustment. No additional parts required.

**ED4200S/ED4200/ED4400/ED4800 SecureBolt®, Rim, Surface and Concealed V.R. Trim**

Cylinder is not included.

**Escutcheon Trim Design: PR8 Princeton**



**Lever:** Cast

**Escutcheon:** Wrought



Function	Description	Finish: 613E, 630	Finish: 605, 606, 611, 612, 613, 618, 619, 625, 626, 629, 722
PR810	Passage	\$588.00	\$614.00
PR850	Dummy		
PR855	Classroom <sup>1</sup>		
PR859	Storeroom		

**Escutcheon Trim Design: G8 Global**

**Knob:** Wrought

**Escutcheon:** Wrought



Function	Description	Finish: 613E, 630	Finish: 605, 606, 611, 612, 613, 618, 619, 625, 626, 629, 722
G810	Passage	\$543.00	\$569.00
G850	Dummy		
G855	Classroom <sup>1</sup>		
G859	Storeroom		

**Escutcheon Trim Design: F4 Plate**

**Plate:** Wrought



Function	Description	Finish: 613E, 630	Finish: 605, 606, 611, 612, 613, 618, 619, 625, 626, 629, 722
F450	Dummy	\$222.00	\$248.00
F457	Nightlatch		

**Escutcheon Trim Design: O8 Plate x Thumbturn**

**Plate:** Wrought

**Thumbturn:** Cast



Function	Description	Finish: 613E, 630	Finish: 605, 606, 612, 613, 722
O810	Passage	\$471.00	\$497.00
O855 <sup>1</sup>	Classroom		
O859	Storeroom		

Note:

1. Classroom function trim may be converted to storeroom function by a simple field adjustment. No additional parts required.

**ED4200S/ED4200/ED4400/ED4800 SecureBolt®, Rim, Surface and Concealed V.R. Trim**

Cylinder is not included.

**Escutcheon Trim Design: O14 Plate x Thumbturn**

**Pull:** Cast      **Escutcheon:** Wrought      **Thumbturn:** Cast



Function	Description	Finish: 613E, 630	Finish: 605, 606, 611, 612, 613, 618, 619, 625, 626, 629, 722
O1410	Passage	\$577.00	\$603.00
O1455 <sup>1</sup>	Classroom		
O1459	Storeroom		

**Escutcheon Trim Design: T14 Pull/Thumbpiece**

**Grip:** Cast      **Escutcheon:** Wrought



Function	Description	Finish: 613E, 630	Finish: 605, 606, 611, 612, 613, 618, 619, 625, 626, 629, 722
T1410	Passage	\$557.00	\$583.00
T1450	Dummy	\$487.00	\$513.00
T1455 <sup>1</sup>	Classroom	\$557.00	\$583.00
T1457	Nightlatch (see note 2)	\$487.00	\$513.00

**Escutcheon Trim Design: P10 Pull**



**Pull:** Extruded      **Escutcheon:** Wrought



Function	Description	Finish: 613E, 630	Finish: 605, 606, 611, 612, 613, 618, 619, 625, 626, 629, 722
P1050	Dummy	\$562.00	\$588.00
P1057	Nightlatch (see note 2)		

**Escutcheon Trim Design: K1 Key Only**

Note: Available with cylinder option only. Example: K157 x 6P



Function	Description	Finish: 605, 606, 611, 612, 613, 618, 619, 622, 625, 626, 722
K157	Nightlatch <sup>2</sup>	\$55.00

Notes:

1. Classroom function trim may be converted to storeroom function by a simple field adjustment. No additional parts required.
2. Not recommended for use on surface or concealed vertical rod exit devices.

**Offset Pull Trim: P12, P13, P14**

Offset Pull Trim	Part Number	Finishes: 613E, 630	Finishes: 605, 606, 612, 613, 626, 629
P12	716F50M X Finish	\$258.00	\$272.00
P13	716F51M X Finish	\$316.00	\$330.00
P14	716F52M X Finish	\$223.00	\$237.00

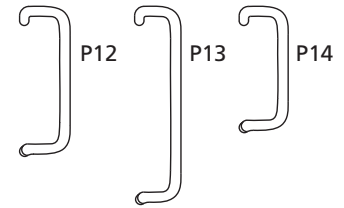
**Electrified Options for Exit Devices**

Description	Specify	Add or Deduct
Exit Alarm Device (cylinder is not included)	M61	\$682.00
Bolt Position Monitoring	M91*	Add \$217.00
Touchbar Monitoring or Signaling/Request to Exit (REX)	M92*	Add \$204.00
Outside Trim Monitoring or Signaling	M93*	
Motor Latch Retraction	MELR	\$835.00
Electric Dogging	M97	Add \$416.00

**Delayed Egress Device**

Description	Specify	Add or Deduct
Delayed Egress (Suffix the letter D to device. Ex: ED4200)	D	Add \$1533.00
30-Second Delay	M88*	\$103.00
BOCA 15-Second Delay	M89*	
BOCA 30-Second Delay	M90*	

**Electrified Accessories**

Part Number	Description	Specify	Price
709F609	Power Supply 1 Amp (controls 1 'D' device)	BPS-24-1	\$327.00
709F619	Power Supply 2 Amp (controls 2 'D' devices or 1 "D" with SAF or SEC)	BPS-24-2	\$664.00
709F269	Power Supply 4 amp 24VDC	BPS-24-4	\$1,079.00
704F288	Concealed transfer (for over 120-degree swing door)	EPTL	\$124.00
709F689	(1) SPDT Maintained Switch (Includes LED)	MKA	\$124.00
709F709	(1) SPDT Momentary Switch (Includes LED)	MK	\$189.00
709F749	(1) SPDT Momentary Switch (Illuminated)	PB2	\$145.00
709F759	(1) SPDT Maintained (Alternating Action) Switch	PB3EA	\$111.00
709F769	(1) SPDT Momentary Switch (Illuminated)	PB3	\$140.00
709F779	(1) SPDT Momentary Switch	PB3ER	\$93.00
709F729	DPDT Momentary Key Switch	MK2	\$217.00
709F699	Narrow Stile Key Switch (Alt. action)	MKAN	\$189.00
709F719	Narrow Stile Momentary Key Switch	MKN	\$189.00
709F789	Sonalert 90db @ 2 ft. 12-24VDC. Mounted on one gang stainless steel plate.	PZ1	\$93.00
	Alarm Kit (cylinder is not included) <sup>1</sup>	ED40AK	\$774.00
709F679	Door Cord	TSK-C	\$28.00
741F739	Digital Entry System (4 users)	DK-12	\$246.00
709F809	Digital Entry System (59 users) ST finish	DK-26ST	\$555.00
709F819	Digital Entry System (59 users) Black finish	DK-26BK	\$555.00
709F669	Power Transfer	EPT	\$93.00

**Notes:**

- Alarm kit cannot be installed in the field to surface vertical rod exit device. Any attempt to do so voids all warranties.

**\*ElectroLynx®**

As part of their promise to provide innovative, fast and effective high security solutions to their customers, certain ASSA ABLOY Group brands offer **ElectroLynx®**, a universal quick-connect system that simplifies the electrification of the door opening.

### Cylinder Options\*

Description	Specify	Add or Deduct
Conventional 6-pin	6P**	Add \$83.00 per cylinder
Conventional 7-pin	7P	Add \$85.00 per cylinder
Access 3 Patented	AP	Add \$83.00 per cylinder
Access 3 Security	AS	Add \$132.00 per cylinder
Access 3 High Security, UL 437	AHS	Add \$152.00 per cylinder
Access 3 IC Patented	ACP	Add \$154.00 per cylinder
Access 3 IC Security	ACS	Add \$203.00 per cylinder
Access 3 IC High Security, UL 437	ACHS	Add \$223.00 per cylinder
Pyramid Security fixed core	PS	Add \$138.00 per cylinder
Pyramid Security IC	PCS	Add \$197.00 per cylinder
Pyramid High Security fixed core	PHS	Add \$167.00 per cylinder
Pyramid High Security IC	PCHS	Add \$235.00 per cylinder
Pyramid IC with temporary construction core	CTP	Add \$154.00 per cylinder
Pyramid IC with temporary disposable core	CTPD	Add \$83.00 per cylinder
Pyramid IC less core	CLP	Add \$83.00 per cylinder
Security	HS	Add \$189.00 per cylinder
Security IC	CHS	Add \$259.00 per cylinder
Blockout function	BO	Add \$172.00 per cylinder
IC 6-pin	C6	Add \$154.00 per cylinder
IC 6-pin with temporary construction core (Red)	CT6R	Add \$154.00 per cylinder
IC 6-pin with temporary construction core (Blue)	CT6B	Add \$154.00 per cylinder
IC 6-pin with temporary construction core (Green)	CT6G	Add \$154.00 per cylinder
IC 6-pin with temporary disposable core	CT6D	Add \$83.00 per cylinder
IC 6-pin less core	CL6	Add \$83.00 per cylinder
SFIC 6-pin with Less Core	CLS6	Add \$83.00 per cylinder
IC 6-pin with SFIC disposable temporary core	CT6SD	Add \$83.00 per cylinder
IC 7-pin	C7	Add \$158.00 per cylinder
IC 7-pin with temporary construction core ( Red)	CT7R	Add \$158.00 per cylinder
IC 7-pin with temporary construction core ( Blue)	CT7B	Add \$158.00 per cylinder
IC 7-pin with temporary construction core ( Green)	CT7G	Add \$158.00 per cylinder
IC 7-pin with temporary disposable core	CT7D	Add \$85.00 per cylinder
IC 7-pin less core	CL7	Add \$85.00 per cylinder
SFIC 7-pin with Less Core	CLS7	Add \$85.00 per cylinder
IC 7-pin with SFIC disposable temporary core	CT7SD	Add \$85.00 per cylinder

\*Optional dogging cylinder will be furnished with the same mechanism and keyed alike with the trim cylinder, unless otherwise specified. If different keying or cylinder type is required, specify outside (trim) first, then inside (dogging) cylinder.

\*\*6P cylinder option is supplied in 6-pin, L4 keyway, 0-bitted with two nickel silver keys.

### Keying Options\*

Description	Specify	Add or Deduct
0-Bitted with 2 blank keys	(standard)	No Charge
Keyed random	KR	No Charge
Master keyed (all cylinders except 8000, 8020, 8027 IC)	specify keyset	Add \$16.00 per cylinder
Master keyed Pyramid	specify keyset	Add \$16.00 per cylinder
Master keyed Security (including IC cylinder and core)	specify keyset	Add \$16.00 per cylinder
Master keyed (8000, 8020, 8027 IC core)	specify keyset	No Charge
Master keyed to customer bittings or sample key	specify keyset	Add \$16.00 per cylinder
Construction master keyed <sup>1,2</sup>	CMK	Add \$16.00 per cylinder
Visual key control (VKC)		
- No Stamping	VKC0	\$4.50
- Keys only	VKC1	No Charge
- Cylinders and Keys <sup>3</sup>	VKC2	\$8.00
- Cylinders only <sup>3</sup>	VKC3	\$8.00
Concealed key control (CKC)		
- CKC cylinders with VKC keys	CKC2	\$8.00
- CKC cylinders only <sup>3</sup>	CKC3	\$8.00
More than 2 keys per lock	KY# (e.g., KY6)	See page 66 - Cut Keys Section

\*For key bows other than 10 and 90, specify "KB" + bow number as Quick Code, e.g. KB12.

Notes:

1. CMK Construction master keying charge is in addition to master keying charge.

2. CMK Construction master keying is not available in Pyramid or Security series.

3. VKC2, VKC3, CKC3 are not available in Pyramid or Security series.



**Door Height Options**
**ED4400 Device**

Door Height	Specify	Add or Deduct
7'0"	(standard)	No Charge
7'2"	H0702	
7'6"	H0706	
8'0"	H0800	
9'0"	H0900	
10'0"	H1000	Add \$82.00 per device

**ED4800 Device**

Door Height	Specify	Add or Deduct
8'0"	(standard)	No Charge
8'2"	H0802	
8'6"	H0806	
9'0"	H0900	Add \$82.00 per device
10'0"	H1000	

**Door Width Options**

Door Width	Specify	Add or Deduct
24"	W024	Add \$292.00 per device
36"	(standard)	No Charge
48"	W048	Add \$35.00 per device

**Door Thickness Options**

Door Thickness	Specify	Add or Deduct
1-3/4"	(standard)	No Charge
2"	D200	
2-1/4"	D214	

**Strike Options**

Description	Specify	Add or Deduct
Surface or concealed vertical rod	S09	No Charge
Bottom strike for 1/2" threshold		
Flush transom top strike bracket	M67	Add \$30.00 per device

**Miscellaneous Options**

Description	Specify	Add or Deduct
Torx® screws for rim, concealed vertical rod, mortise	M04	Add \$42.00 per device
Torx® screws for surface vertical rod	M04	Add \$80.00 per device
Knurling outside and inside (Embossed Touchbar - device side)	M20	Add \$139.00 per device
Knurling outside only (trim side)	M21	Add \$65.00 per device
Knurling inside only (Embossed Touchbar - device side)	M22	Add \$74.00 per device
Abrasive coat outside and inside (trim and device)	M23	Add \$88.00 per device
Abrasive coat inside only (device side)	M24	Add \$46.00 per device
Abrasive coat outside only (trim side)	M25	Add \$42.00 per device
Pathlite™ Photoluminescent Touchbar cover	M49	Add \$348.00 per device
Less dogging	M51	No Charge
Cylinder dogging (less cylinder)	M52	Add \$78.00 per device
Sex nuts and bolts (SNBs)	M54	No Charge
Mullion stabilizer*	M57	Add \$62.00 per mullion
Shim kit (for vision light)		
- All rim and concealed vertical rod	M58	Add \$96.00 per device
- All surface vertical rod	M58	Add \$96.00 per device
End Cap Reinforcement (used with standard end cap only)	M109	Add \$78.00 per device
Flush End Cap	M110	No Charge

**Removable Mullion**
**Ordering Example**

Quantity	Mullion Number	Finish
10	808	628

Door Height	Specify	Finish	Price
Up to 8'0"	808	628	\$1,377.00
Up to 8'0"	808	695	\$1,581.00

\*Standard with all 808 mullions.

**Custom Laser Engraving- LASER**
**Laser engraving processing charge (all engraving types)**

- \$250 net per order. Charge will be applied to production order when placed.

**Single Vanity, Logo or Other (same engraving on all parts)**

- Lever - \$10 net add each
- Mortise Escutcheon - \$10 net add each
- HPSK Paddle - \$10 net add each

**Unique laser engraving (i.e. Room Number, Apartment Number, etc)**

- \$12 net add each (per piece)



The PathLite™ patent pending technology offers a number of benefits:

- Requires no wiring or maintenance
- Recharges with exposure to ambient light
- Unaffected by heat or cold
- Non-toxic, will not rub off or fade
- Vandal resistant
- Fire resistant and non-radioactive
- Green contrasting word "EXIT" centered on touchbar in 1-1/4" high lettering
- Cost effective; especially suited for existing buildings

PathLite™ photoluminescent exit devices meet New York City's newly adopted standards for requirement of photoluminescent signage and stairwell markings in all office buildings in excess of 75 feet in height.

**How To Order Complete Device**

Exit Device	Trim/Function	Finish	Hand	Misc. Options
ED5200	N910	630	RHR	M49

ED5200 x N910 x 630 x RHR x M49

Options	Specify	Price
24", 36", and 48" PathLite™ Photoluminescent Touchbar Cover	M49	Add \$348.00 per device

**How to Order Touchbar Cover Only**

Options	Part Number	Price
24" PathLite™ Photoluminescent Touchbar cover	710F797	\$374.00
36" PathLite™ Photoluminescent Touchbar cover	710F737	
48" PathLite™ Photoluminescent Touchbar cover	710F747	

**Standard Features**

**Handing**

Devices are field reversible; specify hand. Lever trims are handed; specify hand.

Note:

Specify hand for all double cylinder exit devices

**Door Thickness**

1-3/4"

**Door Width**

36"

**Projection**

3-1/4"; 2-3/4" dogged

**Trim**

Cylinder is not included. See page 258 for cylinder options.

**SecureBolt®**

- ED5200S Panic
- ED5200SA 3 Hour Fire Rated
- ED5202S Double Cylinder Panic, SecureBolt®
- ED5202SA Double Cylinder, Secure Bolt, 3 Hour Fire Rated

**RIM**

- ED5200 Panic
- ED5200A 3 Hour Fire Rated
- ED5202 Double Cylinder Panic
- ED5202A Double Cylinder; 3 Hour fire rated

**Vertical Rod**

- ED5400 Panic
- ED5470 Panic
- ED5400A 3 Hour Fire Rated
- ED5470B 1-1/2 Hour Fire Rated

**Concealed Vertical Rod**

- ED5800 Panic
- ED5860 Panic
- ED5800A 3 Hour Fire Rated
- ED5860B 1-1/2 Hour Fire Rated

**Mortise**

- ED5600 Panic
- ED5600A 3 Hour Fire Rated
- ED5602L Double Cylinder Panic (Classroom Function)
- ED5602AL Double Cylinder (Classroom Function); 3 Hour Fire Rated

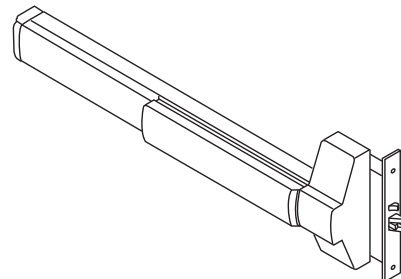
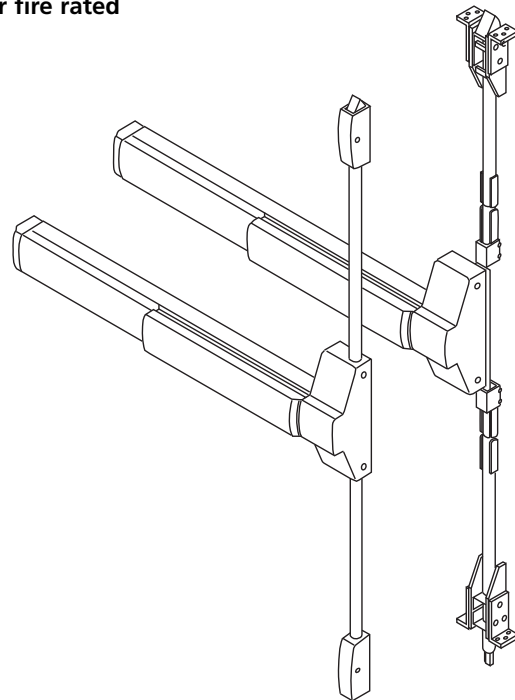
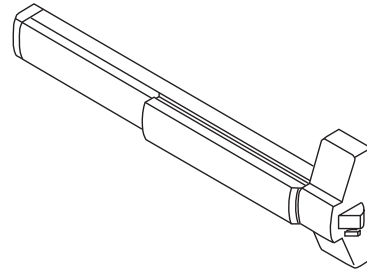

**Ordering Examples**
**Exit Device with Trim**

Quantity	Exit Device	Trim/Function	Finish	Hand	Door Thickness	Optional Strike	Door Width	Misc. Options
36	ED5600L	N9M55	605	LHR	D200	SB134	W048	M51-M54

**Trim Only**

Quantity	Trim/Function	Finish	Hand	Door Thickness
24	N955	625	RHR	D214

**Contract/Detailed Order - Rim Exit Device with Trim**

Quantity	Keypad	Exit Device	Trim/Function	Finish	Hand	Door Thickness	Door Width	Misc. Options	Optional Cylinder
36	AA1	ED5200	C955	626	LHR	D200	W048	M52-M54	6P

## Notes:

M55 less bottom rod option is available on ED5470(B) and ED5860(B) devices only.  
 H0900 and H1000 options are available on ED5470(B) and ED5860(B) devices only.  
 Non fire rated devices do not have a door size limitation set by UL.

**36" Device Only**

Includes device, strike(s) and screw pack. No cylinder or trim.

**SecureBolt® ED5200S Series**

Function	Description	Finish: 613E, 630*	Finish: 605, 606, 611, 612, 613, 618, 619, 625, 629, 722
ED5200S	Panic	\$1,524.00	\$1,620.00
ED5202S <sup>1</sup>	Double Cylinder Panic <i>Classroom function Trim only</i>	\$1,746.00	\$1,842.00
ED5200SA	3 Hour Fire Rated	\$1,687.00	\$1,783.00
ED5202SA <sup>1</sup>	Double Cylinder 3 Hour Fire Rated <i>Classroom function Trim only</i>	\$1,909.00	\$2,005.00

**Rim ED5200 Series**

Function	Description	Finish: 613E, 630*	Finish: 605, 606, 611, 612, 613, 618, 619, 625, 629, 722
ED5200	Panic	\$1,456.00	\$1,552.00
ED5202 <sup>1</sup>	Double Cylinder Panic <i>Classroom function Trim only</i>	\$1,678.00	\$1,774.00
ED5200A	3 Hour Fire Rated	\$1,619.00	\$1,715.00
ED5202A <sup>1</sup>	Double Cylinder 3 Hour Fire Rated <i>Classroom function Trim only</i>	\$1,841.00	\$1,937.00

**Vertical Rod ED5400 Series**

Function	Description	Finish: 613E, 630*	Finish: 605, 606, 611, 612, 613, 618, 619, 625, 629, 722
ED5400	Panic	\$2,002.00	\$2,098.00
ED5470	Panic	\$2,068.00	\$2,164.00
ED5400A	3 Hour Fire Rated	\$2,165.00	\$2,261.00
ED5470B	1-1/2 Hour Fire Rated	\$2,231.00	\$2,327.00

**Mortise ED5600 Series**

Function	Description	Finish: 613E, 630*	Finish: 605, 606, 611, 612, 613, 618, 619, 625, 629, 722
ED5600K	Panic	\$1,970.00	\$2,066.00
ED5657K			
ED5600L			
ED5657L			
ED5600T			
ED5657T	Double Cylinder Panic <i>Classroom function Trim only</i>	\$2,192.00	\$2,288.00
ED5602L <sup>1</sup>			
ED5600AK			
ED5657AK			
ED5600AL			
ED5657AL	3 Hour Fire Rated	\$2,133.00	\$2,229.00
ED5600AT			
ED5657AT			
ED5602AL <sup>1</sup>			
ED5633L			
ED5634L	Access 800® Only - Panic – Without Cylinder	\$1,970.00	\$2,066.00
ED5634L	Access 800® Only - Panic – With Cylinder	\$1,970.00	\$2,066.00
ED5633AL	Access 800® Only - 3 Hour Fire Rated – Without Cylinder	\$2,133.00	\$2,229.00
ED5634AL	Access 800® Only - 3 Hour Fire Rated – With Cylinder	\$2,133.00	\$2,229.00

**Concealed V.R. ED5800 Series**

Function	Description	Finish: 613E, 630*	Finish: 605, 606, 611, 612, 613, 619, 625, 629, 722
ED5800	Panic	\$2,259.00	\$2,355.00
ED5860	Panic	\$2,391.00	\$2,487.00
ED5800A	3 Hour Fire Rated	\$2,422.00	\$2,518.00
ED5860B	1-1/2 Hour Fire Rated	\$2,554.00	\$2,650.00

**Inactive Bar ED5000DB Series**

Function	Description	Finish: 613E, 630*	Finish: 605, 606, 611, 612, 613, 619, 625, 629, 722
ED5000DB	Inactive Bar	\$718.00	\$814.00

For rim, surface and concealed vertical rod exit trim prices, see pages 247-251.  
 For mortise exit device trim prices see pages 252-256.  
 1. Specify handing for double cylinder devices

Only classroom function trim can be used with double cylinder devices.  
 Caution: Be sure of your measurements. Exit devices are NOT returnable.  
 \* Contact factory for 626 finish availability.

**ED5200S/ED5200/ED5400/ED5800 SecureBolt®, Rim, Surface and CVR Heavy-Duty Trim**

Cylinder is not included.

**Escutcheon Trim Design: A9 Armstrong**



**Lever:** Cast

**Escutcheon:** Forged

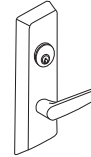

Function	Description	Finish: 613E, 630 <sup>1</sup>	Finish: 605, 606, 611, 612, 613, 618, 619, 625, 626, 629 <sup>2</sup> , 722
A910	Passage	\$633.00	\$659.00
A950	Dummy		
A955	Classroom <sup>3, 4</sup>		
A957	Nightlatch <sup>5</sup>		
A959	Storeroom		

**Escutcheon Trim Design: C9 Citation**



**Lever:** Cast

**Escutcheon:** Forged

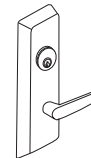

Function	Description	Finish: 613E, 630 <sup>1</sup>	Finish: 605, 606, 611, 612, 613, 618, 619, 625, 626, 629 <sup>2</sup> , 722
C910	Passage	\$633.00	\$659.00
C950	Dummy		
C955	Classroom <sup>3, 4</sup>		
C957	Nightlatch <sup>5</sup>		
C959	Storeroom		

**Escutcheon Trim Design: D9 Dirke**



**Lever:** Cast

**Escutcheon:** Forged

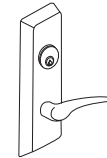

Function	Description	Finish: 613E, 630 <sup>1</sup>	Finish: 605, 606, 611, 612, 613, 618, 619, 625, 626, 629 <sup>2</sup> , 722
D910	Passage	\$633.00	\$659.00
D950	Dummy		
D955	Classroom <sup>3, 4</sup>		
D957	Nightlatch <sup>5</sup>		
D959	Storeroom		

Notes:

1. 619 finish provided to match 630 finish
2. 618 finish provided to match 629 finish.
3. Classroom function trim may be converted to storeroom function by a simple field adjustment. No additional parts required.
4. Only Classroom function may be used with Double Cylinder exit devices.
5. Not recommended for use with surface or concealed vertical rod exit devices (ED5400, ED5800)

**ED5200S/ED5200/ED5400/ED5800 SecureBolt®, Rim, Surface and CVR Heavy-Duty Trim**

Cylinder is not included.

**Escutcheon Trim Design: E9 Essex**



**Lever:** Cast      **Escutcheon:** Forged

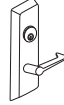

Function	Description	Finish: 613E, 630 <sup>1</sup>	Finish: 605, 606, 611, 612, 613, 618, 619, 625, 626, 629 <sup>2</sup> , 722
E910	Passage	\$633.00	\$659.00
E950	Dummy		
E955	Classroom <sup>3,4</sup>		
E957	Nightlatch <sup>5</sup>		
E959	Storeroom		

**Escutcheon Trim Design: L9 Lustra**



**Lever:** Cast      **Escutcheon:** Forged

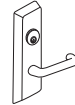

Function	Description	Finish: 613E, 630 <sup>1</sup>	Finish: 605, 606, 611, 612, 613, 618, 619, 625, 626, 629 <sup>2</sup> , 722
L910	Passage	\$633.00	\$659.00
L950	Dummy		
L955	Classroom <sup>3,4</sup>		
L957	Nightlatch <sup>5</sup>		
L959	Storeroom		

**Escutcheon Trim Design: N9 Newport**



**Lever:** Cast      **Escutcheon:** Forged

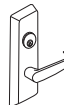

Function	Description	Finish: 613E, 630 <sup>1</sup>	Finish: 605, 606, 611, 612, 613, 618, 619, 625, 626, 629 <sup>2</sup> , 722
N910	Passage	\$633.00	\$659.00
N950	Dummy		
N955	Classroom <sup>3,4</sup>		
N957	Nightlatch <sup>5</sup>		
N959	Storeroom		

**Escutcheon Trim Design: R9 Regis**



**Lever:** Cast      **Escutcheon:** Forged

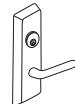

Function	Description	Finish: 613E, 630 <sup>1</sup>	Finish: 605, 606, 611, 612, 613, 618, 619, 625, 626, 629 <sup>2</sup> , 722
R910	Passage	\$633.00	\$659.00
R950	Dummy		
R955	Classroom <sup>3,4</sup>		
R957	Nightlatch <sup>5</sup>		
R959	Storeroom		

Notes:  
 1. 619 finish provided to match 630 finish. - Escutcheons only  
 2. 618 finish provided to match 629 finish. - Escutcheons only  
 3. Classroom function trim may be converted to storeroom function by a simple field adjustment. No additional parts required.

4. Only Classroom function trim may be used with Double Cylinder exit devices.  
 5. Not recommended for use with surface or concealed vertical rod exit devices (ED5400, ED5800)



**ED5200S/ED5200/ED5400/ED5800 SecureBolt®, Rim, Surface and CVR Heavy-Duty Trim**

Cylinder is not included.

**Escutcheon Trim Design: PR9 Princeton**



**Lever:** Cast

**Escutcheon:** Forged



Function	Description	Finish: 613E, 630 <sup>1</sup>	Finish: 605, 606, 611, 612, 613, 618, 619, 625, 626, 629 <sup>2</sup> , 722
PR910	Passage	\$633.00	\$659.00
PR950	Dummy		
PR955	Classroom <sup>3,4</sup>		
PR957	Nightlatch <sup>5</sup>		
PR959	Storeroom		

**Escutcheon Trim Design: F9**

**Lever:** Cast

**Escutcheon:** Forged



Function	Description	Finish: 613E, 630 <sup>1</sup>	Finish: 605, 606, 611, 612, 613, 618, 619, 625, 626, 629 <sup>2</sup> , 722
F950	Dummy	\$271.00	\$297.00
F957	Nightlatch <sup>5</sup>		

**Escutcheon Trim Design: G9**

**Lever:** Cast

**Escutcheon:** Forged



Function	Description	Finish: 613E, 630 <sup>1</sup>	Finish: 605, 606, 611, 612, 613, 618, 619, 625, 626, 629 <sup>2</sup> , 722
G910	Passage	\$633.00	\$659.00
G950	Dummy		
G955	Classroom <sup>3,4</sup>		
G957	Nightlatch <sup>5</sup>		
G959	Storeroom		

**Escutcheon Trim Design: VT9**

**Plate:** Stamped or Formed Stainless Steel



Function	Description	Finish: 630 <sup>1</sup>
VT957	Nightlatch <sup>6</sup>	\$570.00
VTL957	Nightlatch with Lip <sup>6</sup>	
VT950	Pull	
VTL950	Pull with Lip	

Notes:

1. 619 finish provided to match 630 finish. - Escutcheons only
2. 618 finish provided to match 629 finish. - Escutcheons only
3. Classroom function trim may be converted to storeroom function by a simple field adjustment. No additional parts required.

4. Only Classroom function trim may be used with Double Cylinder exit devices.
5. Not recommended for use with surface or concealed vertical rod exit devices (ED5400, ED5800)
6. VT957 and VTL957 trims are handed and not reversible

**ED5200S/ED5200/ED5400/ED5800 SecureBolt®, Rim, Surface and CVR Heavy-Duty Trim**

Cylinder is not included.

**Escutcheon Trim Design: FR9 Frascati\***



**Escutcheon:** Forged

\* Handed Lever. Handing cannot be changed in the field.



Function	Description	Finish: 613E, 626	Finish: 605, 606, 611, 612, 613, 618, 619, 625, 722
FR910	Passage	\$633.00	\$659.00
FR950	Dummy		
FR955	Classroom <sup>3,4</sup>		
FR957	Nightlatch <sup>5</sup>		
FR959	Storeroom		

**Escutcheon Trim Design: M9 Merlot**



**Escutcheon:** Forged

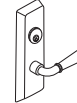

Function	Description	Finish: 613E, 626	Finish: 605, 606, 611, 612, 613, 618, 619, 625, 722
M910	Passage	\$633.00	\$659.00
M950	Dummy		
M955	Classroom <sup>3,4</sup>		
M957	Nightlatch <sup>5</sup>		
M959	Storeroom		

**Escutcheon Trim Design: Z9 Zinfandel\***



**Escutcheon:** Forged

\* Handed Lever. Handing cannot be changed in the field.

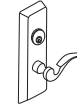

Function	Description	Finish: 613E, 626	Finish: 605, 606, 611, 612, 613, 618, 619, 625, 722
Z910	Passage	\$633.00	\$659.00
Z950	Dummy		
Z955	Classroom <sup>3,4</sup>		
Z957	Nightlatch <sup>5</sup>		
Z959	Storeroom		

Notes:

3. Classroom function trim may be converted to storeroom function by a simple field adjustment. No additional parts required.

4. Only Classroom function trim may be used with Double Cylinder exit devices.  
5. Not recommended for use with surface or concealed vertical rod exit devices.

**ED5200S/ED5200/ED5400/ED5800 SecureBolt®, Rim, Surface and CVR Trim**

Cylinder is not included.

**Escutcheon Trim Design: TH900 Pull/Thumbpiece**

**Grip:** Extruded

**Escutcheon:** Forged



Function	Description	Finish: 613E, 630 <sup>1</sup>	Finish: 605, 606, 611, 612, 613, 618, 619, 625, 626, 629 <sup>2</sup> , 722
TH910	Passage	\$457.00	\$483.00
TH950	Dummy (No thumbpiece)	\$427.00	\$453.00
TH955	Classroom <sup>3,4</sup>	\$457.00	\$483.00
TH957	Nightlatch <sup>5</sup> (No thumbpiece)	\$427.00	\$453.00
TH959	Storeroom	\$427.00	\$453.00

**Escutcheon Trim Design: P9 Pull**



**Pull:** Extruded

**Escutcheon:** Forged

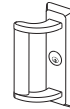

Function	Description	Finish: 613E, 630 <sup>1</sup>	Finish: 605, 606, 611, 612, 613, 618, 619, 625, 626, 629 <sup>2</sup> , 722
P950*	Dummy	\$392.00	\$418.00
P957*	Nightlatch <sup>5</sup>		

\* Specify Hand. Field Reversible.

**Escutcheon Trim Design: K1 Key Only**

**Note:** Only available with cylinder option. Example K157 x 6P



Function	Description	Finish: 605, 606, 611, 612, 613, 618, 619, 622, 625, 626, 722
K157	Nightlatch <sup>5</sup>	\$55.00

Note:

1. 619 finish provided to match 630 finish. - Escutcheons only
2. 618 finish provided to match 629 finish. - Escutcheons only
3. Classroom function trim may be converted to storeroom function by a simple field adjustment. No additional parts required.
4. Only Classroom function trim may be used with Double Cylinder exit devices.
5. Not recommended for use on surface or concealed vertical rod exit devices.

**ED5600 Mortise Heavy-Duty Trim**

Cylinder is not included.

**Escutcheon Trim Design: A4M Armstrong**



**Lever:** Cast

**Escutcheon:** Forged

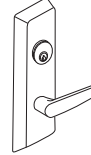

Function	Description	Finish: 613E, 630 <sup>1</sup>	Finish: 605, 606, 611, 612, 613, 618, 619, 625, 626, 629 <sup>2</sup> , 722
A9M10	Passage <sup>3</sup>	\$633.00	\$659.00
A9M50	Dummy <sup>3</sup>		
A9M55	Classroom <sup>4, 5</sup>		
A9M57	Nightlatch <sup>4</sup>		

**Escutcheon Trim Design: C9M Citation**



**Lever:** Cast

**Escutcheon:** Forged

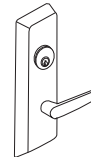

Function	Description	Finish: 613E, 630 <sup>1</sup>	Finish: 605, 606, 611, 612, 613, 618, 619, 625, 626, 629 <sup>2</sup> , 722
C9M10	Passage <sup>3</sup>	\$633.00	\$659.00
C9M50	Dummy <sup>3</sup>		
C9M55	Classroom <sup>4, 5</sup>		
C9M57	Nightlatch <sup>4</sup>		

**Escutcheon Trim Design: D9M Dirke\***



**Lever:** Cast

**Escutcheon:** Forged

\* Handed Lever. Handing cannot be changed in the field.

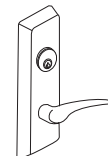

Function	Description	Finish: 613E, 630 <sup>1</sup>	Finish: 605, 606, 611, 612, 613, 618, 619, 625, 626, 629 <sup>2</sup> , 722
D9M10	Passage <sup>3</sup>	\$633.00	\$659.00
D9M50	Dummy <sup>3</sup>		
D9M55	Classroom <sup>4, 5</sup>		
D9M57	Nightlatch <sup>4</sup>		

Notes:  
 1. 619 finish provided to match 630 finish. - Escutcheons only  
 2. 618 finish provided to match 629 finish. - Escutcheons only  
 3. Dummy and passage functions are the same. For dummy function, mortise lock body must be installed in the locked mode. No additional parts required.  
 4. Classroom and nightlatch function trims are the same. Trim function must be specified when ordered with an exit device to ensure that the correct lock body is supplied.  
 5. Only Classroom function trim may be used with Double Cylinder exit devices.

**ED5600 Mortise Heavy-Duty Trim**

Cylinder is not included.

**Escutcheon Trim Design: E9M Essex**



**Lever:** Cast

**Escutcheon:** Forged

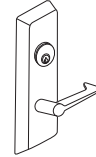

Function	Description	Finish: 613E, 630 <sup>1</sup>	Finish: 605, 606, 611, 612, 613, 618, 619, 625, 626, 629 <sup>2</sup> , 722
E9M10	Passage <sup>3</sup>	\$633.00	\$659.00
E9M50	Dummy <sup>3</sup>		
E9M55	Classroom <sup>4, 5</sup>		
E9M57	Nightlatch <sup>4</sup>		

**Escutcheon Trim Design: L9M Lustra**



**Lever:** Cast

**Escutcheon:** Forged

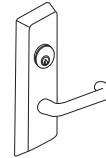

Function	Description	Finish: 613E, 630 <sup>1</sup>	Finish: 605, 606, 611, 612, 613, 618, 619, 625, 626, 629 <sup>2</sup> , 722
L9M10	Passage <sup>3</sup>	\$633.00	\$659.00
L9M50	Dummy <sup>3</sup>		
L9M55	Classroom <sup>4, 5</sup>		
L9M57	Nightlatch <sup>4</sup>		

**Escutcheon Trim Design: N9M Newport**



**Lever:** Cast

**Escutcheon:** Forged

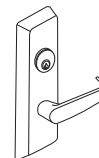

Function	Description	Finish: 613E, 630 <sup>1</sup>	Finish: 605, 606, 611, 612, 613, 618, 619, 625, 626, 629 <sup>2</sup> , 722
N9M10	Passage <sup>3</sup>	\$633.00	\$659.00
N9M50	Dummy <sup>3</sup>		
N9M55	Classroom <sup>4, 5</sup>		
N9M57	Nightlatch <sup>4</sup>		

Notes:

1. 619 finish provided to match 630 finish. - Escutcheons only
2. 618 finish provided to match 629 finish. - Escutcheons only
3. Dummy and passage functions are the same. For dummy function, mortise lock body must be installed in the locked mode. No additional parts required.
4. Classroom and nightlatch function trims are the same. Trim function must be specified when ordered with an exit device to ensure that the correct lock body is supplied.
5. Only Classroom function trim may be used with Double Cylinder exit devices.

**ED5600 Mortise Heavy-Duty Trim**

Cylinder is not included.

**Escutcheon Trim Design: R9M Regis**



**Lever:** Cast      **Escutcheon:** Forged

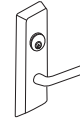

Function	Description	Finish: 613E, 630 <sup>1</sup>	Finish: 605, 606, 611, 612, 613, 618, 619, 625, 626, 629 <sup>2</sup> , 722
R9M10	Passage <sup>3</sup>	\$633.00	\$659.00
R9M50	Dummy <sup>3</sup>		
R9M55	Classroom <sup>4, 5</sup>		
R9M57	Nightlatch <sup>4</sup>		

**Escutcheon Trim Design: PR9M Princeton**



**Lever:** Cast      **Escutcheon:** Forged



Function	Description	Finish: 613E, 630 <sup>1</sup>	Finish: 605, 606, 611, 612, 613, 618, 619, 625, 626, 629 <sup>2</sup> , 722
PR9M10	Passage <sup>3</sup>	\$633.00	\$659.00
PR9M50	Dummy <sup>3</sup>		
PR9M55	Classroom <sup>4, 5</sup>		
PR9M57	Nightlatch <sup>4</sup>		

**Escutcheon Trim Design: F9**

**Escutcheon:** Forged



Function	Description	Finish: 613E, 630 <sup>1</sup>	Finish: 605, 606, 611, 612, 613, 618, 619, 625, 626, 629 <sup>2</sup> , 722
F950	Dummy	\$271.00	\$297.00
F9M57	Nightlatch <sup>4</sup>		

**Escutcheon Trim Design: G9M**

**Escutcheon:** Forged



Function	Description	Finish: 613E, 630 <sup>1</sup>	Finish: 605, 606, 611, 612, 613, 618, 619, 625, 626, 629 <sup>2</sup> , 722
G9M10	Passage <sup>3</sup>	\$633.00	\$659.00
G9M50	Dummy <sup>3</sup>		
G9M55	Classroom <sup>4, 5</sup>		
G9M57	Nightlatch <sup>4</sup>		

**Notes:**

- 619 finish provided to match 630 finish. - Escutcheons only
- 618 finish provided to match 629 finish. - Escutcheons only
- Dummy and passage functions are the same. For dummy function, mortise lock body must be installed in the locked mode. No additional parts required.

- Classroom and nightlatch function trims are the same. Trim function must be specified when ordered with an exit device to ensure that the correct lock body is supplied.
- Only Classroom function trim may be used with Double Cylinder exit devices.

**ED5600 Mortise Heavy-Duty Trim**

Cylinder is not included.

**Escutcheon Trim Design: FR9M Frascati\***



**Lever:** Cast

**Escutcheon:** Forged



\* Handed Lever. Handing cannot be changed in the field.

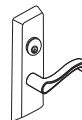

Function	Description	Finish: 613E, 626	Finish: 605, 606, 611, 612, 613, 618, 619, 625, 722
FR9M10	Passage <sup>1</sup>	\$633.00	\$659.00
FR9M50	Dummy <sup>1</sup>		
FR9M55	Classroom <sup>2, 3</sup>		
FR9M57	Nightlatch <sup>2</sup>		

**Escutcheon Trim Design: M9M Merlot**



**Lever:** Cast

**Escutcheon:** Forged

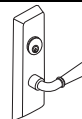

Function	Description	Finish: 613E, 626	Finish: 605, 606, 611, 612, 613, 618, 619, 625, 722
M9M10	Passage <sup>1</sup>	\$633.00	\$659.00
M9M50	Dummy <sup>1</sup>		
M9M55	Classroom <sup>2, 3</sup>		
M9M57	Nightlatch <sup>2</sup>		

**Escutcheon Trim Design: Z9M Zinfandel\***



**Lever:** Cast

**Escutcheon:** Forged



\* Handed Lever. Handing cannot be changed in the field.

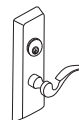

Function	Description	Finish: 613E, 626	Finish: 605, 606, 611, 612, 613, 618, 619, 625, 722
Z9M10	Passage <sup>1</sup>	\$633.00	\$659.00
Z9M50	Dummy <sup>1</sup>		
Z9M55	Classroom <sup>2, 3</sup>		
Z9M57	Nightlatch <sup>2</sup>		

Notes:

- Dummy and passage functions are the same. For dummy function, mortise lock body must be installed in the locked mode. No additional parts required.
- Classroom and nightlatch function trims are the same. Trim function must be specified when ordered with an exit device to ensure that the correct lock body is supplied.
- Only Classroom function trim may be used with Double Cylinder exit devices.

**Mortise Trim Design: ED5600**

Cylinder is not included.

**Escutcheon Trim Design: TH900, TH9M00 Pull/Thumbpiece**

**Grip:** Extruded      **Escutcheon:** Forged



Function	Description	Finish: 613E, 630 <sup>1</sup>	Finish: 605, 606, 611, 612, 613, 618, 619, 625, 626, 629 <sup>2</sup> , 722
TH9M10	Passage	\$457.00	\$483.00
TH950	Dummy (No Thumbpiece)	\$427.00	\$453.00
TH9M55	Classroom <sup>3</sup>	\$457.00	\$483.00
TH9M57	Nightlatch (No Thumbpiece)	\$427.00	\$453.00

**Escutcheon Trim Design: P9M Pull**



**Pull:** Extruded      **Escutcheon:** Forged

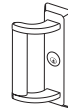

Function	Description	Finish: 613E, 630 <sup>1</sup>	Finish: 605, 606, 611, 612, 613, 618, 619, 625, 626, 629 <sup>2</sup> , 722
P950*	Dummy	\$392.00	\$418.00
P9M57*	Nightlatch		

\*Specify Hand. Field Reversible.

**Escutcheon Trim Design: VT9M**

**Plate:** Stamped or Formed Stainless Steel



Function	Description	Finish: 630
VT9M57	Nightlatch	\$570.00
VTL9M57	Nightlatch with Lip	

Note: For mortise exit dummy functions, specify VT950 and VTL950

**Escutcheon Trim Design: K1M Key Only**

Note: Available with cylinder option only. Example: K1M57 x 6P



Function	Description	Finish: 605, 606, 611, 612, 613, 618, 619, 622, 625, 626, 722
K1M57	Nightlatch	\$55.00

Note:  
 1. 619 finish provided to match 630 finish. - Escutcheons only  
 2. 618 finish provided to match 629 finish. - Escutcheons only  
 3. Only Classroom function trim may be used with Double Cylinder exit devices.



**ED5200S/ED5200/ED5400/ED5800 SecureBolt®, Rim, Surface & CVR Heavy-Duty Trim**

Cylinder is not included.

**Escutcheon Trim Design: A9 Armstrong**



**Lever:** Cast    **Escutcheon:** Forged

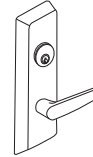

Function	Description	Finish: 613E, 630 <sup>1</sup>	Finish: 605, 606, 611, 612, 613, 618, 619, 625, 626, 629 <sup>2</sup> , 722
A9903*	Fail Safe	\$1,021.00	\$1,047.00
A9905*	Fail Secure		

**Escutcheon Trim Design: C9 Citation**



**Lever:** Cast    **Escutcheon:** Forged

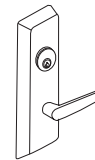

Function	Description	Finish: 613E, 630 <sup>1</sup>	Finish: 605, 606, 611, 612, 613, 618, 619, 625, 626, 629 <sup>2</sup> , 722
C9903*	Fail Safe	\$1,021.00	\$1,047.00
C9905*	Fail Secure		

**Escutcheon Trim Design: D9 Dirke\***



**Lever:** Cast    **Escutcheon:** Forged  
\* Handed Lever. Handing cannot be changed in the field.

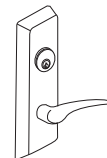

Function	Description	Finish: 613E, 630 <sup>1</sup>	Finish: 605, 606, 611, 612, 613, 618, 619, 625, 626, 629 <sup>2</sup> , 722
D9903*	Fail Safe	\$1,021.00	\$1,047.00
D9905*	Fail Secure		

**Escutcheon Trim Design: E9 Essex**



**Lever:** Cast    **Escutcheon:** Forged

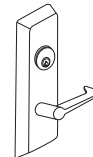

Function	Description	Finish: 613E, 630 <sup>1</sup>	Finish: 605, 606, 611, 612, 613, 618, 619, 625, 626, 629 <sup>2</sup> , 722
E9903*	Fail Safe	\$1,021.00	\$1,047.00
E9905*	Fail Secure		

Notes:  
1. 619 finish provided to match 630 finish. - Escutcheons only  
2. 618 finish provided to match 629 finish. - Escutcheons only



\*ElectroLynx®  
As part of their promise to provide innovative, fast and effective high security solutions to their customers, certain ASSA ABLOY Group brands offer *ElectroLynx*®, a universal quick-connect system that simplifies the electrification of the door opening.

**ED5200S/ED5200/ED5400/ED5800 SecureBolt®, Rim, Surface & CVR Heavy-Duty Trim**

Cylinder is not included.

**Escutcheon Trim Design: L9 Lustra**



**Lever:** Cast    **Escutcheon:** Forged

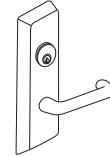

Function	Description	Finish: 613E, 630 <sup>1</sup>	Finish: 605, 606, 611, 612, 613, 618, 619, 625, 626, 629 <sup>2</sup> , 722
L9903*	Fail Safe	\$1,021.00	\$1,047.00
L9905*	Fail Secure		

**Escutcheon Trim Design: N9 Newport**



**Lever:** Cast    **Escutcheon:** Forged

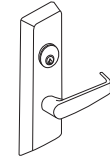

Function	Description	Finish: 613E, 630 <sup>1</sup>	Finish: 605, 606, 611, 612, 613, 618, 619, 625, 626, 629 <sup>2</sup> , 722
N9903*	Fail Safe	\$1,021.00	\$1,047.00
N9905*	Fail Secure		

**Escutcheon Trim Design: R9 Regis**



**Lever:** Cast    **Escutcheon:** Forged

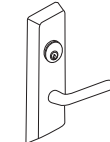

Function	Description	Finish: 613E, 630 <sup>1</sup>	Finish: 605, 606, 611, 612, 613, 618, 619, 625, 626, 629 <sup>2</sup> , 722
R9903*	Fail Safe	\$1,021.00	\$1,047.00
R9905*	Fail Secure		

**Escutcheon Trim Design: PR9 Princeton**



**Lever:** Cast    **Escutcheon:** Forged

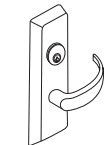

Function	Description	Finish: 613E, 630 <sup>1</sup>	Finish: 605, 606, 611, 612, 613, 618, 619, 625, 626, 629 <sup>2</sup> , 722
PR9903*	Fail Safe	\$1,021.00	\$1,047.00
PR9905*	Fail Secure		

Notes:  
 1. 619 finish provided to match 630 finish. - Escutcheons only  
 2. 618 finish provided to match 629 finish. - Escutcheons only



\*ElectroLynx®  
 As part of their promise to provide innovative, fast and effective high security solutions to their customers, certain ASSA ABLOY Group brands offer *ElectroLynx*®, a universal quick-connect system that simplifies the electrification of the door opening.

**ED5200S/ED5200/ED5400/ED5800 SecureBolt®, Rim, Surface & CVR Heavy-Duty Trim**

Cylinder is not included.

**Escutcheon Trim Design: FR9 Frascati**



**Lever:** Cast    **Escutcheon:** Forged

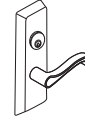

Function	Description	Finish: 613E, 626	Finish: 605, 606, 611, 612, 613, 618, 619, 625, 722
FR9903*	Fail Safe	\$1,021.00	\$1,047.00
FR9905*	Fail Secure		

**Escutcheon Trim Design: M9 Merlot**



**Lever:** Cast    **Escutcheon:** Forged

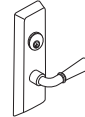

Function	Description	Finish: 613E, 626	Finish: 605, 606, 611, 612, 613, 618, 619, 625, 722
M9903*	Fail Safe	\$1,021.00	\$1,047.00
M9905*	Fail Secure		

**Escutcheon Trim Design: Z9 Zinfandel**



**Lever:** Cast    **Escutcheon:** Forged

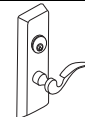

Function	Description	Finish: 613E, 626	Finish: 605, 606, 611, 612, 613, 618, 619, 625, 722
Z9903*	Fail Safe	\$1,021.00	\$1,047.00
Z9905*	Fail Secure		



\*ElectroLynx®

As part of their promise to provide innovative, fast and effective high security solutions to their customers, certain ASSA ABLOY Group brands offer *ElectroLynx*®, a universal quick-connect system that simplifies the electrification of the door opening.

**Offset Pull Trim: P12, P13, P14**

Offset Pull Trim	Part Number	Finish: 613E, 630	Finishes: 605, 606, 612, 613, 626, 629
P12	716F50M X Finish	\$258.00	\$272.00
P13	716F51M X Finish	\$316.00	\$330.00
P14	716F52M X Finish	\$223.00	\$237.00

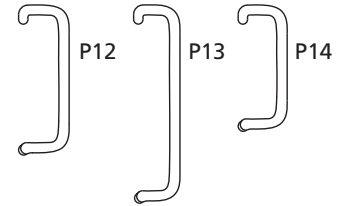
**Electrified Options for Exit Devices**

Description	Specify	Add or Deduct
Exit Alarm Device (cylinder is not included)	M61	\$682.00
Bolt Position Monitoring	M91*	Add \$217.00
Touchbar Monitoring or Signaling/Request to Exit (REX)	M92*	Add \$204.00
Outside Trim Monitoring or Signaling	M93*	
Motor Latch Retraction	MELR	\$835.00
Electric Dogging	M97*	Add \$416.00
SPDT Lock and Unlock security monitor switch (Electric Trim Only)	M98*	Add \$196.00
Trim gasket for exterior applications (Electric Trim Only)	M99	Add \$22.00
Mortise device lock with Outside Trim Control (Fail Safe)	SAF <sup>2</sup> *	\$686.00
Mortise device lock with Outside Trim Control (Fail Secure)	SEC <sup>2</sup> *	

**Delayed Egress Device**

Description	Suffix	Add or Deduct
Delayed Egress (Suffix the letter D to device. Ex: ED4200)	D	Add \$1533.00
30-Second Delay	M88*	\$103.00
BOCA 15-Second Delay	M89*	
BOCA 30-Second Delay	M90*	

**Notes:**

- Alarm kit cannot be installed in the field to surface vertical rod exit device. Any attempt to do so voids all warranties.
- Only available with ED5600(A) (Except knob trim)
- M88, M89 and M90 are available only as options for suffix "D" Delayed Egress Exit Devices.
- The following options cannot be ordered together on the same device: a) M94 or M97 & D; b) M94 x M97; c) M52 x M97; d) M97 x M107; e) M61 or M92 & D; f) M61 x M92; g) M61x M52; h) M52 & D; i) ED5600 x M91 & M93; j) ED5600 SAF or SEC x M91 or M93; k) Surface vertical rod exit devices with M61 x M91, M92 or M93.

**\*ElectroLynx®**

As part of their promise to provide innovative, fast and effective high security solutions to their customers, certain ASSA ABLOY Group brands offer **ElectroLynx®**, a universal quick-connect system that simplifies the electrification of the door opening.

**Retrofit Kit: MELR rail assy, no switches, no latch, with controller, touchbar end cap**

Description	Specify	Price
Device ASSY, MELR 36"	727F158	\$835.00
Device ASSY, MELR 36" NS (Narrow Stile)	727F228	
Device ASSY, MELR 48"	727F238	
Device ASSY, MELR WS 36" Device	727F248	
Device ASSY, MELR WS 48" Device	727F258	

**Electrified Accessories**

Part Number	Description	Specify	Price
709F609	Power Supply 1 Amp (controls 1 "D" device)	BPS-24-1	\$327.00
709F619	Power Supply 2 Amp (controls 2 "D" devices or 1 "D" with SAF or SEC)	BPS-24-2	\$664.00
709F629	Power Supply 4 amp 24VDC	BPS-24-4	\$1,079.00
704F288	Concealed transfer (for over 120-degree swing door)	EPTL	\$124.00
709F689	(1) SPDT Maintained Switch (Includes LED)	MKA	\$124.00
709F709	(1) SPDT Momentary Switch (Includes LED)	MK	\$189.00
709F749	(1) SPDT Momentary Switch (Illuminated)	PB2	\$145.00
709F759	(1) SPDT Maintained (Alternating Action) Switch	PB3EA	\$111.00
709F769	(1) SPDT Momentary Switch (Illuminated)	PB3	\$140.00
709F779	(1) SPDT Momentary Switch	2' PB3ER	\$93.00
709F729	DPDT Momentary Key Switch	2' MK2	\$217.00
709F699	Narrow Stile Key Switch (Alt. action)	MKAN	\$189.00
704F719	Narrow Stile Momentary Key Switch	MKN	\$189.00
709F789	Sonalert 90db @ 2 ft. 12-24VDC Mounted on one gang stainless steel plate.	PZ1	\$93.00
	Alarm Kit (cylinder is not included) <sup>1</sup>	ED50AK	\$774.00
709F679	Door Cord	TSB-C	\$28.00
741F739	Digital Entry System (4 users)	DK-12	\$246.00
709F809	Digital Entry System (59 users) SS finish	FADK-26SS	\$555.00
709F819	Digital Entry System (59 users) Black finish	DK-26BK	\$555.00
709F669	Power Transfer	EPT	\$93.00
709F989	Remote Power Harness – 36"		\$134.00
709F999	Remote Power Harness – 48"		\$148.00

**Custom Laser Engraving- LASER**
**Laser engraving processing charge (all engraving types)**

- \$250 net per order. Charge will be applied to production order when placed.

**Single Vanity, Logo or Other (same engraving on all parts)**

- Lever - \$10 net add each
- Mortise Escutcheon - \$10 net add each
- HPSK Paddle - \$10 net add each

**Unique laser engraving (i.e. Room Number, Apartment Number, etc)**

- \$12 net add each (per piece)

**Cylinder Options\***

Description	Specify	Add or Deduct
Conventional 6-pin	6P**	Add \$83.00 per cylinder
Conventional 7-pin	7P	Add \$85.00 per cylinder
Access 3 Patented	AP	Add \$83.00 per cylinder
Access 3 Security	AS	Add \$132.00 per cylinder
Access 3 High Security, UL 437	AHS	Add \$152.00 per cylinder
Access 3 IC Patented	ACP	Add \$154.00 per cylinder
Access 3 IC Security	ACS	Add \$203.00 per cylinder
Access 3 IC High Security, UL 437	ACHS	Add \$223.00 per cylinder
Pyramid Security fixed core	PS	Add \$138.00 per cylinder
Pyramid Security IC	PCS	Add \$197.00 per cylinder
Pyramid High Security fixed core	PHS	Add \$167.00 per cylinder
Pyramid High Security IC	PCHS	Add \$235.00 per cylinder
Pyramid IC with temporary construction core	CTP	Add \$154.00 per cylinder
Pyramid IC with temporary disposable core	CTPD	Add \$83.00 per cylinder
Pyramid IC less core	CLP	Add \$83.00 per cylinder
Security	HS	Add \$189.00 per cylinder
Security IC	CHS	Add \$259.00 per cylinder
Blockout function	BO	Add \$172.00 per cylinder
IC 6-pin	C6	Add \$154.00 per cylinder
IC 6-pin with temporary construction core (Red)	CT6R	Add \$154.00 per cylinder
IC 6-pin with temporary construction core (Blue)	CT6B	Add \$154.00 per cylinder
IC 6-pin with temporary construction core (Green)	CT6G	Add \$154.00 per cylinder
IC 6-pin with temporary disposable core	CT6D	Add \$83.00 per cylinder
IC 6-pin less core	CL6	Add \$83.00 per cylinder
SFIC 6-pin with Less Core	CLS6	Add \$83.00 per cylinder
IC 6-pin with SFIC disposable temporary core	CT6SD	Add \$83.00 per cylinder
IC 7-pin	C7	Add \$158.00 per cylinder
IC 7-pin with temporary construction core (Red)	CT7R	Add \$158.00 per cylinder
IC 7-pin with temporary construction core (Blue)	CT7B	Add \$158.00 per cylinder
IC 7-pin with temporary construction core (Green)	CT7G	Add \$158.00 per cylinder
IC 7-pin with temporary disposable core	CT7D	Add \$85.00 per cylinder
IC 7-pin less core	CL7	Add \$85.00 per cylinder
SFIC 7-pin with Less Core	CLS7	Add \$85.00 per cylinder
IC 7-pin with SFIC disposable temporary core	CT7SD	Add \$85.00 per cylinder

\*Optional dogging cylinder will be furnished with the same mechanism and keyed alike with the trim cylinder, unless otherwise specified. If different keying or cylinder type is required, specify outside (trim) first, then inside (dogging) cylinder.

\*\*6P cylinder option is supplied in 6-pin, L4 keyway, 0-bitted with two nickel silver keys.

**Keying Options\***

Description	Specify	Add or Deduct
0-Bitted with 2 blank keys	(standard)	No Charge
Keyed random	KR	No Charge
Master keyed (all cylinders except 8000, 8020, 8027 IC)	specify keyset	Add \$16.00 per cylinder
Master keyed Pyramid	specify keyset	Add \$16.00 per cylinder
Master keyed Security (including IC cylinder and core)	specify keyset	Add \$16.00 per cylinder
Master keyed (8000, 8020, 8027 IC core)	specify keyset	No Charge
Master keyed to customer bittings or sample key	specify keyset	Add \$16.00 per cylinder
Construction master keyed <sup>1,2</sup>	CMK	Add \$16.00 per cylinder
Visual key control (VKC)		
- No Stamping	VKC0	\$4.50
- Keys only	VKC1	No Charge
- Cylinders and Keys <sup>3</sup>	VKC2	\$8.00
- Cylinders only <sup>3</sup>	VKC3	\$8.00
Concealed key control (CKC)		
- CKC cylinders with VKC keys	CKC2	\$8.00
- CKC cylinders only <sup>3</sup>	CKC3	\$8.00
More than 2 keys per lock	KY# (e.g., KY6)	See page 66 - Cut Keys Section

\*For key bows other than 10 and 90, specify "KB" + bow number as Quick Code, e.g. KB12.

Notes:

1. CMK Construction master keying charge is in addition to master keying charge.

2. CMK Construction master keying is not available in Pyramid or Security series.

3. VKC2, VKC3, CKC3 are not available in Pyramid or Security series.

**Door Height Options**
**ED5400, ED5400A, ED5470(B) Devices**

Door Height	Specify	Add or Deduct
7'0"	(standard)	No Charge
7'2"	H0702	
7'6"	H0706	
8'0"	H0800	

**ED5800, ED5800A, ED5860(B) Devices**

Door Height	Specify	Add or Deduct
8'0"	(standard)	No Charge

**ED5470(B), ED5860(B) Devices**

Door Height	Specify	Add or Deduct
9'0" <sup>1</sup>	H0900	Add \$82.00 per device
10'0" <sup>1</sup>	H1000	

**Door Width Options**

Door Width	Specify	Add or Deduct
24"	W024	Add \$292.00 per device
36"	(standard)	No Charge
48"	W048	Add \$35.00 per device

**Door Thickness Options**

Door Thickness	Specify	Add or Deduct
1-3/4"	(standard)	No Charge
2"	D200	
2-1/4"	D214	

**Strike Options**

Description	Specify	Add or Deduct
Rim x Vertical Rod on pairs of doors	S02	Add \$36.00 per device
Surface or Concealed Vertical Rod device bottom strike for 1/2" threshold	S09	No Charge
Flush transom top strike bracket	M67	Add \$30.00 per device
Mortise Device		
-ANSI wrought strike box	M17	No Charge
-ANSI strike for pair of doors w/astragal (7/8" L to C)	SS078	
-Open back strike for 1-3/4" door	SB134	Add \$80.00 per device
-Open back strike for 2-1/4" door	SB214	\$128.00

Note:  
 1. H0900 and H1000 options for ED5470(B), ED5860(B) devices only

**Miscellaneous Options**

Description	Specify	Add or Deduct
Torx® screws for rim, concealed vertical rod, mortise	M04	Add \$42.00 per device
Torx® screws for surface vertical rod	M04	Add \$80.00 per device
Knurling outside and inside (Embossed Touchbar - device side) <sup>1</sup>	M20	Add \$139.00 per device
Knurling outside only (trim side) <sup>1</sup>	M21	Add \$65.00 per device
Knurling inside only (Embossed Touchbar - device side)	M22	Add \$74.00 per device
Abrasive coat outside and inside (trim and device)	M23	Add \$88.00 per device
Abrasive coat inside only (device side)	M24	Add \$46.00 per device
Abrasive coat outside only (trim side)	M25	Add \$42.00 per device
Pathlite™ Photoluminescent Touchbar cover	M49	Add \$348.00 per device
Less dogging	M51	No Charge
Cylinder dogging (less cylinder)	M52	Add \$78.00 per device
Sex nuts and bolts (SNBs)	M54	No Charge
Less bottom vertical rod <sup>2</sup>	M55	
Narrow stile cover	M56	No Charge
Shim kit (for vision light)		
- All rim and concealed vertical rod	M58	Add \$72.00 per device
- All surface vertical rod	M58	Add \$96.00 per device
- All mortise exit devices	M58	Add \$96.00 per device
Parabolic Design Exit Trim	M60	Add \$78.00 per device
Wood screws For use on fire rated solid wood or wood core doors	M64	No Charge
Windstorm Certified products for ED5200S(A) and ED5470(B) Only <sup>3, 4, 5</sup>	M107	Add \$85.00 per device
End Cap Reinforcement (used with standard end cap only)	M109	Add \$78.00 per device
Flush End Cap	M110	No Charge

## Notes:

1. Not available with VT9, VTL9, VT9M and VTL9M trim.
2. Available with ED5470 and ED5860 series only.
3. ED5200S(A) x M107 requires through bolts.
4. ED5470(B) maximum opening height is 8'0".
5. Contact Ceco, Curries® or Fleming for detailed frame/door requirements and limitations.

**Surface Bolt™**

Description	Specify	Price
Surface Bolt Kit For Approved Windstorm Code Applications - bright zinc plated finish	988CR	\$135.00



**Mullions**
**Ordering Example**

Quantity	Mullion Number
10	907A

**Removable Mullions**

Door Height	Description	Specify	Price
Up to 7'0"	Steel Mullion - Panic Rated	907	\$636.00
Up to 8'0"	Steel Mullion - Panic Rated	908	\$646.00
Up to 10'0" (ED5200, ED5200S only)	Steel Mullion - Panic Rated	910	\$766.00
Up to 7'0"	Steel Mullion - 3 Hour Fire Rated	907A	\$883.00
Up to 8'0"	Steel Mullion - 3 Hour Fire Rated	908A	\$893.00
Up to 7'0"	Steel Mullion - 3 Hour Fire Rated, Windstorm Certified	FE707A <sup>1</sup>	\$1,101.00
Up to 8'0"	Steel Mullion - 3 Hour Fire Rated, Windstorm Certified	FE708A <sup>1</sup>	\$1,111.00

**Key Removable Mullions**

Door Height	Description	Specify	Price
Up to 7'0"	Steel Mullion - 1-1/2 Hour Fire Rated	907BKM <sup>2</sup>	\$1,360.00
Up to 8'0"	Steel Mullion - 1-1/2 Hour Fire Rated	908BKM <sup>2</sup>	\$1,370.00
Up to 10'0" (ED5200, ED5200S only)	Steel Mullion - Panic Rated	910KM <sup>2</sup>	\$1,202.00
Up to 7'0"	Steel Mullion - 3 Hour Fire Rated, Windstorm Certified	WS707AKM <sup>2</sup>	\$1,545.00
Up to 8'0"	Steel Mullion - 3 Hour Fire Rated, Windstorm Certified	WS708AKM <sup>2</sup>	\$1,555.00

**Notes:**

1 For use with UL approved door assemblies that comply to FEMA 361 and FEMA 320 guidelines.

For the latest listings on compliant door assemblies visit our website at [corbinrusswin.com](http://corbinrusswin.com)

2 Cylinder and collars not included, specify separately

**Mullions Cylinder Options**

Description	Specify	Add or Deduct
Conventional 6-pin	6P	Add \$83.00 per cylinder
Conventional 7-pin	7P	Add \$85.00 per cylinder
IC 6-pin	C6	Add \$154.00 per cylinder
IC 7-pin	C7	Add \$158.00 per cylinder
Pyramid High Security Fixed Core	PHS	Add \$167.00 per cylinder
Pyramid Security Fixed Core	PS	Add \$138.00 per cylinder
Pyramid High Security IC	PCHS	Add \$235.00 per cylinder
Pyramid Security IC	PCS	Add \$197.00 per cylinder
Security	HS	Add \$189.00 per cylinder
Security IC	CHS	Add \$259.00 per cylinder
IC 6-pin less core	CL6	Add \$83.00 per cylinder
IC 7-pin less core	CL7	Add \$158.00 per cylinder

**Options**

Description	Specify	Add or Deduct
Door frame filler block for double rabbetted frames	M95	Add \$42.00 per mullion
Door frame angle bracket for aluminum frames	M96	Add \$42.00 per mullion
Mullion stabilizer	M57	Add \$62.00 per mullion

**Standard Features**

**Handing**

Handed, specify hand

**Door Thickness**

1-3/4"

**Backset**

2-3/4"

**Projection**

4-7/8"; 3-1/8" depressed

**Trim**

Cylinder is not included.  
See page 292 for  
cylinder options.

**Rim**

ED7200

Panic

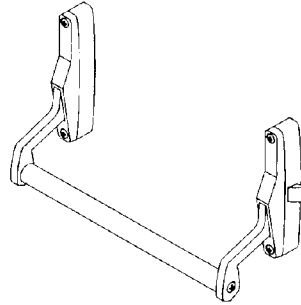

**Vertical Rod**

ED7400

Panic

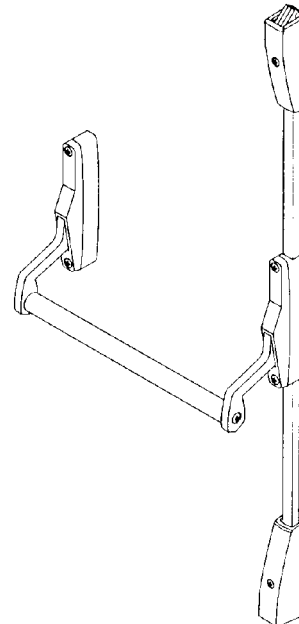

**Concealed Vertical Rod**

ED7800

Panic

ED7800A

3 Hour Fire Rated

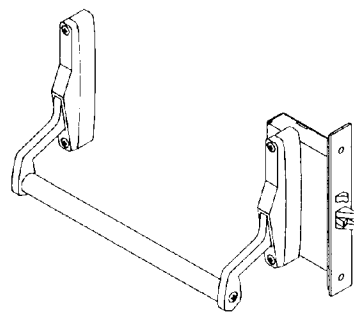

**Mortise**

ED7600

Panic

ED7600A

3 Hour Fire Rated

**Ordering Example**
**Rim Exit Device**

Quantity	Exit Device	Finish	Hand	Misc. Options
20	ED7200	606	RHR	M51-M54

**Rim Exit Device with Trim**

Quantity	Exit Device	Trim/Function	Finish	Hand	Door Thickness	Door Width	Misc. Options
50	ED7200	P557	630	LHR	D214	W048	M53

**Trim Only (Rim Device)**

Quantity	Exit Device	Finish
10	P457	630

**Vertical Rod Exit Device with Trim**

Quantity	Exit Device	Trim/Function	Finish	Hand	Door Thickness	Door Width	Misc. Options
50	ED7401	C455	613	RHR	D214	W048	H1000

**Mortise Exit Device with Trim**

Quantity	Exit Device	Trim/Function	Finish	Hand	Door Thickness	Strike	Door Width
50	ED7600A	T11M55	626	LHR	D200	SB200	W048

**Contract/Detailed Order - Rim Exit Device with Trim**

Quantity	Keypad	Exit Device	Trim/Function	Finish	Hand	Door Thickness	Door Width	Optional Cylinders	Keying
50	AA1	ED7200	P457	626	LHR	D200	W048	C6	VKC3

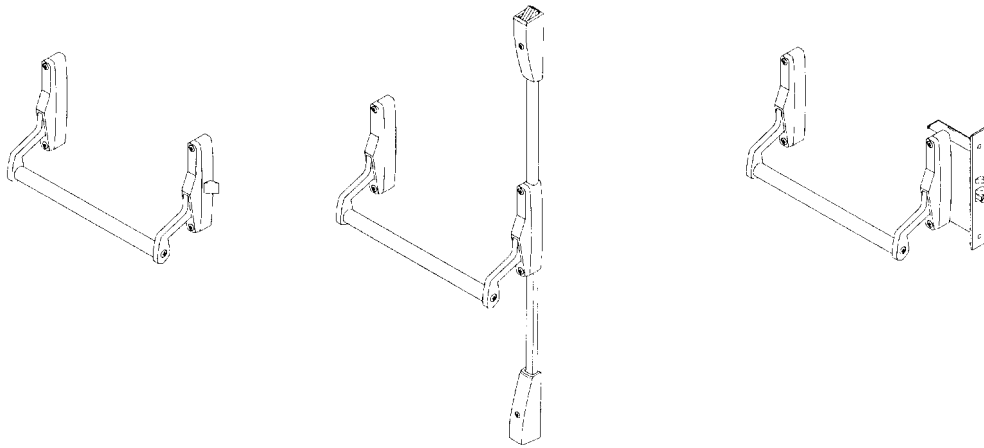

**36" Device Only**

Includes device, strike(s) and screw pack. No cylinder or trim.

**Rim ED7200 Series**

Function	Description	Finish: 613E, 626	Finish: 605, 606, 611, 612, 613, 618, 619, 625, 629, 630, 722
ED7200	Panic	\$2,624.00	\$2,701.00

**Vertical Rod ED7400 Series**

Function	Description	Finish: 613E, 626	Finish: 605, 606, 611, 612, 613, 618, 619, 625, 629, 630, 722
ED7400	Panic Exit Trim Only (accepts operator trim)	\$3,070.00	\$3,147.00
ED7401	Panic Exit Trim Only (accepts lever trim)		

**Mortise ED7600 Series**

Function	Description	Finish: 613E, 626	Finish: 605, 606, 611, 612, 613, 618, 619, 625, 629, 630, 722
ED7600	Panic	\$2,782.00	\$2,859.00
ED7600A	3 Hour Fire Rated		

**Concealed V.R. ED7800 Series**

Function	Description	Finish: 613E, 626	Finish: 605, 606, 611, 612, 613, 618, 619, 625, 629, 630, 722
ED7800	Panic	\$2,960.00	\$3,037.00
ED7800A	3 Hour Fire Rated	\$3,123.00	\$3,200.00

For rim exit trim prices, see page 292.  
 For vertical rod exit trim prices, see page 293.  
 For mortise exit device trim prices see pages 294-295.  
 For concealed vertical rod exit trim prices, see page 295.

Caution: Be sure of your measurements. Exit devices are NOT returnable.

**ED7200 Rim Trim**

Cylinder is not included.

**Pull Trim Design: P4 D Grip Pull**



**Grip:** Extruded

**Escutcheon:** Wrought



Function	Description	Finish: 613E, 626	Finish: 605, 606, 611, 612, 613, 618, 619, 625, 629, 630, 722
P450	Dummy	\$353.00	\$381.00
P457	Nightlatch		

**Pull Trim Design: P5 Round Grip Pull**



**Grip:** Extruded

**Escutcheon:** Wrought



Function	Description	Finish: 613E, 626	Finish: 605, 606, 611, 612, 613, 618, 619, 625, 629, 630, 722
P550	Dummy	\$353.00	\$381.00
P557	Nightlatch		

**Pull Trim Design: P6 Pull**



**Grip:** Wrought  
MR option available

**Escutcheon:** Wrought

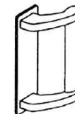

Function	Description	Finish: 613E, 626	Finish: 605, 606, 611, 612, 613, 618, 619, 625, 629, 630, 722
P650	Dummy	\$353.00	\$381.00
P657	Nightlatch		

**Pull Trim Design: P7 Plate**

**Escutcheon:** Wrought  
MR option available

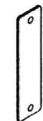

Function	Description	Finish: 613E, 626	Finish: 605, 606, 611, 612, 613, 618, 619, 625, 629, 630, 722
P757	Nightlatch	\$345.00	\$373.00

**ED7400 Surface Vertical Rod Trim**

Cylinder is not included.

**Escutcheon Trim Design: C4 Citation**



**Lever:** Cast  
MR option available

**Escutcheon:** Wrought  
Available with ED7401 device only.

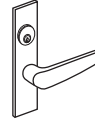

Function	Description	Finish: 613E, 626	Finish: 605, 606, 611, 612, 613, 618, 619, 625, 629, 630, 722
C455*	Classroom	\$739.00	\$767.00
C457*	Nightlatch		

\*1-3/4 doors only

**Escutcheon Trim Design: D4 Dirke**



**Lever:** Cast  
MR option available

**Escutcheon:** Wrought  
Available with ED7401 device only.



Function	Description	Finish: 613E, 626	Finish: 605, 606, 611, 612, 613, 618, 619, 625, 629, 630, 722
D455*	Classroom	\$739.00	\$767.00
D457*	Nightlatch		

\*1-3/4 doors only

**Escutcheon Trim Design: O3 D Grip Operator**



**Pull:** Extruded  
MR option available

**Escutcheon:** Cast  
Available with ED7400 only.



Function	Description	Finish: 613E, 626	Finish: 605, 606, 611, 612, 613, 618, 619, 625, 629, 630, 722
O355	Classroom	\$739.00	\$767.00
O356**	Nightlatch		
O357	Nightlatch		

**Escutcheon Trim Design: O4 Round Grip Operator**



**Pull:** Extruded  
MR option available

**Escutcheon:** Cast  
Available with ED7400 only.



Function	Description	Finish: 613E, 626	Finish: 605, 606, 611, 612, 613, 618, 619, 625, 629, 630, 722
O455	Classroom	\$739.00	\$767.00
O456**	Nightlatch		
O457	Nightlatch		

\*\*Key also used to hold top and bottom latchbolts in retracted position.

**ED7600 Mortise Trim**

Cylinder is not included.

**Escutcheon Trim Design: C4M Citation**



**Lever:** Cast

**Escutcheon:** Cast

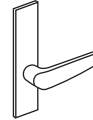

Function	Description	Finish: 613E, 626	Finish: 605, 606, 611, 612, 613, 618, 619, 625, 629, 630, 722
C4M10	Passage	\$739.00	\$767.00
C4M55	Classroom		

**Escutcheon Trim Design: D4M Dirke**



**Lever:** Cast

**Escutcheon:** Cast

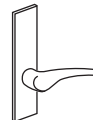

Function	Description	Finish: 613E, 626	Finish: 605, 606, 611, 612, 613, 618, 619, 625, 629, 630, 722
D4M10	Passage	\$739.00	\$767.00
D4M55	Classroom		

**Escutcheon Trim Design: G6M Global**

**Knob:** Wrought Reinforced

**Escutcheon:** Cast



Function	Description	Finish: 613E, 626	Finish: 605, 606, 611, 612, 613, 618, 619, 625, 722
G6M10	Passage	\$739.00	\$767.00
G6M50	Dummy		
G6M55	Classroom		

**ED7600 Mortise Trim**

Cylinder is not included.

**Thumbpiece Trim Design: T11M D Grip**

**Grip:** Extruded      **Escutcheon:** Cast



Function	Description	Finish: 613E, 626	Finish: 605, 606, 611, 612, 613, 618, 619, 625, 629, 630, 722
T11M10	Passage	\$544.00	\$572.00
T11M50	Dummy		
T11M55	Classroom		
T11M57	Nightlatch		

**Thumbpiece Trim Design: T12M Round Grip**

**Grip:** Extruded      **Escutcheon:** Cast



Function	Description	Finish: 613E, 626	Finish: 605, 606, 611, 612, 613, 618, 619, 625, 629, 630, 722
T12M10	Passage	\$544.00	\$572.00
T12M50	Dummy		
T12M55	Classroom		
T12M57	Nightlatch		

**ED7800 Concealed Vertical Rod Trim**

Cylinder is not included.

**Trim Design: O5 Operator**

**Escutcheon:** Cast



Function	Description	Finish: 613E, 626	Finish: 605, 606, 611, 612, 613, 618, 619, 625, 629, 630, 722
O557	Nightlatch	\$263.00	\$299.00

**Offset Pull Trim: P12, P13, P14**

Offset Pull Trim	Part Number	Finish: 613E, 630	Finishes: 605, 606, 612, 613, 626, 629
P12	716F50M X Finish	\$258.00	\$272.00
P13	716F51M X Finish	\$316.00	\$330.00
P14	716F52M X Finish	\$223.00	\$237.00

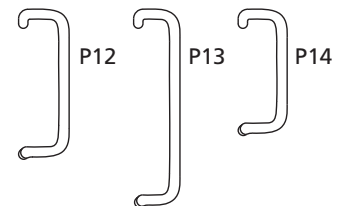



**Cylinder Options**

Description	Specify	Add or Deduct
Conventional 6-pin <sup>7</sup>	6P*	Add \$83.00 per cylinder
Conventional 7-pin <sup>7</sup>	7P	Add \$85.00 per cylinder
Access 3 Patented	AP	Add \$83.00 per cylinder
Access 3 Security	AS	Add \$132.00 per cylinder
Access 3 High Security, UL 437	AHS	Add \$152.00 per cylinder
Access 3 IC Patented	ACP	Add \$154.00 per cylinder
Access 3 IC Security	ACS	Add \$203.00 per cylinder
Access 3 IC High Security, UL 437	ACHS	Add \$223.00 per cylinder
Pyramid Security fixed core <sup>1, 5, 6</sup>	PS	Add \$138.00 per cylinder
Pyramid Security IC <sup>2, 6</sup>	PCS	Add \$197.00 per cylinder
Pyramid High Security fixed core <sup>1, 5, 6</sup>	PHS	Add \$167.00 per cylinder
Pyramid High Security IC <sup>2, 6</sup>	PCHS	Add \$235.00 per cylinder
Pyramid IC with temporary construction core <sup>2, 6</sup>	CTP	Add \$154.00 per cylinder
Pyramid IC with temporary disposable core <sup>1, 3, 6</sup>	CTPD	Add \$83.00 per cylinder
Pyramid IC less core <sup>2, 6</sup>	CLP	Add \$83.00 per cylinder
Security <sup>1</sup>	HS	Add \$189.00 per cylinder
Security IC <sup>2</sup>	CHS	Add \$259.00 per cylinder
Blockout function	BO	Add \$172.00 per cylinder
IC 6-pin <sup>2</sup>	C6	Add \$154.00 per cylinder
IC 6-pin with temporary construction core <sup>2</sup> (Red)	CT6R	Add \$154.00 per cylinder
IC 6-pin with temporary construction core <sup>2</sup> (Blue)	CT6B	Add \$154.00 per cylinder
IC 6-pin with temporary construction core <sup>2</sup> (Green)	CT6G	Add \$154.00 per cylinder
IC 6-pin with temporary disposable core <sup>2</sup>	CT6D	Add \$83.00 per cylinder
IC 6-pin less core <sup>2</sup>	CL6	Add \$83.00 per cylinder
SFIC 6-pin with Less Core	CLS6	Add \$83.00 per cylinder
IC 6-pin with SFIC disposable temporary core	CT6SD	Add \$83.00 per cylinder
IC 7-pin <sup>3</sup>	C7	Add \$158.00 per cylinder
IC 7-pin with temporary construction core <sup>3</sup> (Red)	CT7R	Add \$158.00 per cylinder
IC 7-pin with temporary construction core <sup>3</sup> (Blue)	CT7B	Add \$158.00 per cylinder
IC 7-pin with temporary construction core <sup>3</sup> (Green)	CT7G	Add \$158.00 per cylinder
IC 7-pin with temporary disposable core <sup>3</sup>	CT7D	Add \$85.00 per cylinder
IC 7-pin less core <sup>3</sup>	CL7	Add \$85.00 per cylinder
SFIC 7-pin with Less Core	CLS7	Add \$85.00 per cylinder
IC 7-pin with SFIC disposable temporary core	CT7SD	Add \$85.00 per cylinder
Less master ring cylinder <sup>4</sup>	MR-LC	No Charge
Master Ring <sup>4</sup>	MR	Add \$128.00 per cylinder

\*6P cylinder option is supplied in 6-pin, L4 keyway, 0-bitted with two nickel silver keys.

**Notes:**

1. Available on outside trim only.  
 2. Not available on O5 trim.  
 3. Rim only.

4. Available on C4, D4, OBS, O3, O4 trims only.  
 5. Not available on ED7600 C4M, D4M, E4M B5M, G6M trims.

6. Pyramid is not available on ED7600 with door thicknesses over 2-1/4".  
 7. Not available on P4, P5, P5, P7 trims.

**Keying Options**

Description	Specify	Add or Deduct
0-Bitted with 2 blank keys	(standard)	No Charge
Keyed Random	KR	No Charge
Master Keyed (all cylinders except 8000, 8020, 8027 IC core)	specify keyset	Add \$16.00 per cylinder
Master Keyed Pyramid	specify keyset	Add \$16.00 per cylinder
Master Keyed Security (including IC cylinder and core)	specify keyset	Add \$16.00 per cylinder
Master Keyed (8000, 8020, 8027 IC core)	specify keyset	No Charge
Master Keyed to customer bittings or sample key	specify keyset	Add \$16.00 per cylinder
Construction master keyed <sup>1, 2</sup>	CMK	Add \$16.00 per cylinder
Visual key control (VKC)		
- No Stamping	VKC0	\$4.50
- Keys only	VKC1	No Charge
- Cylinders and Keys <sup>3</sup>	VKC2	\$8.00
- Cylinders only <sup>3</sup>	VKC3	\$8.00
Concealed key control (CKC)		
- CKC cylinders with VKC keys	CKC2	\$8.00
- CKC cylinders only <sup>3</sup>	CKC3	\$8.00
More than 2 keys per lock	KY# (e.g., KY6)	See page 66 - Cut Keys Section

**Notes:**

1. CMK Construction master keying charge is in addition to master keying charge.  
 2. CMK Construction master keying is not available in Pyramid or Security series.  
 3. VKC2, VKC3, CKC3 are not available in Pyramid or Security series.

**Strike Options**

To purchase strike separately, see catalog for part no.

Description	Specify	Add or Deduct
Open rim strike on ED7200	(standard)	No Charge
Rim strike	S07	
Rim strike for aluminum frames with blade stops	S08	
Mortised adjustable rim strike	S04	
Vertical rod top strike on ED7400 device	(standard)	
Vertical rod bottom strike on ED7400		
Vertical rod flush bottom strike on ED7400 device	S03	
Concealed vertical rod top strike on ED7800 device	(standard)	
Fire rated concealed vertical rod top strike on ED7800A device	(standard)	
Fire rated concealed vertical rod bottom strike on ED7800 and ED7800A devices	(standard)	

Description	Lip Length	Specify	Add or Deduct
Mortise straight lip ANSI strike on ED7600, ED7600A	1-1/8"	(standard)	No Charge
	1-1/4"	SS114	
	1-3/8"	SS138	
Mortise open back strike	1-3/4"	SB134	Add \$80.00 per device
	2"	SB200	\$128.00
	2-1/4"	SB214	

**Custom Laser Engraving- LASER**
**Laser engraving processing charge (all engraving types)**

- \$250 net per order. Charge will be applied to production order when placed.

**Single Vanity, Logo or Other (same engraving on all parts)**

- Lever - \$10 net add each
- Mortise Escutcheon - \$10 net add each
- HPSK Paddle - \$10 net add each

**Unique laser engraving (i.e. Room Number, Apartment Number, etc)**

- \$12 net add each (per piece)

<b>Door Width Options</b>		
<b>Description</b>	<b>Specify</b>	<b>Add or Deduct</b>
36"	(standard)	No Charge
48"	W048	Add \$35.00 per device
<b>Door Thickness Options</b>		
<b>Description</b>	<b>Specify</b>	<b>Add or Deduct</b>
1-3/4"	(standard)	No Charge
2" (Not available for ED7800 Series)	D200	
2-1/4" (Not available for ED7800 Series)	D214	
<b>Door Height Options</b>		
<b>Description</b>	<b>Specify</b>	<b>Add or Deduct</b>
7'6" (ED7400 devices)	(standard)	No Charge
7'2" (ED7400A & 7800A devices)	(standard)	
8'6" (ED7800 devices)	(standard)	
10'0" (ED7400 devices only)	H1000	Add \$82.00 per device
10'8" (ED7800 devices only)	H1008	
<b>Miscellaneous Options</b>		
<b>Description</b>	<b>Specify</b>	<b>Add or Deduct</b>
Spanner head screws	M02	Add \$32.00 per device
ANSI wrought strike box (for mortise only)	M17	No Charge
Knurling outside and inside (trim and device)	M20	Add \$139.00 per device
Knurling outside only (trim side)	M21	Add \$65.00 per device
Knurling inside only (device side)	M22	Add \$74.00 per device
Abrasive coat outside and inside (trim and device)	M23	Add \$88.00 per device
Abrasive coat inside only (device side)	M24	Add \$46.00 per device
Abrasive coat outside only (trim side)	M25	Add \$42.00 per device
Stainless steel crossbar <sup>1</sup>		
- When ordered with 626 or 630 finish	M50	No Charge
- All other finishes	M50	Add \$74.00 per device
Less dogging	M51	No Charge
Steel reinforced crossbar	M53	Add \$68.00 per device
Sex nuts and bolts (SNBs)	M54	No Charge
Shim for 2-3/4" backset on doors with 1/2" stop (for ED7200 only)	M59	Add \$22.00 per device
Less latch hold-back (for ED7200 and ED7600 devices only)	M66	No Charge
Note: 1. Not available with M22 or M20 option.		

**Mortise Lock Only**

Includes lockcase, armored front, strike and screw pack. No cylinder.

**Ordering Example**

Qty	Lock Number	Hand	Finish
10	MLE09	RHR	626

Lock Number	Description	Finish: 605, 606, 611, 612, 613, 622, 625, 626, 629, 630
MLE08	ED7600	\$572.00
MLE09	ED7600A	\$582.00

**Removable Mullion**

**Ordering Example**

Quantity	Mullion Number
10	507

Mullion Number	Description	Price
507	For doors up to 7'2"	\$639.00
508	For doors up to 8'0"	\$893.00
510	For doors up to 10'	\$766.00

**Standard Features**

**Handing**

ED8200 Non-handed  
ED8400 Handed; specify hand

**Door Thickness**

1-3/4"

**Backset**

2-3/4"

**Bar Length**

36 standard; 30", 42" and 48"  
available. Easily field cut to size.

**Projection**

2-1/2"

**Trim**

Cylinder is not included.  
See page 303 for  
cylinder options.

**RIM**

ED8200  
ED8200B  
ED8200A

Panic  
1-1/2 Hour Fire Rated  
3 Hour Fire Rated

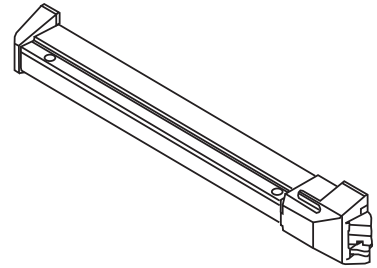

**VERTICAL ROD**

ED8400  
ED8400A

Panic  
3 Hour Fire Rated

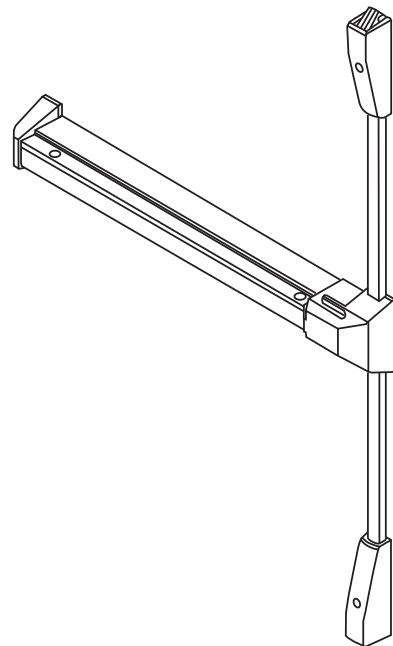

**Ordering Example**

**Rim Exit Device**

Quantity	Exit Device	Finish
20	ED8200	689

**Rim Exit Device with Trim**

Quantity	Exit Device	Trim/Function	Finish		Hand	Door Thickness	Door Width	Misc. Options
			Trim	Device				
50	ED8200A	A657	613	690	RHR	D200	W048	M58

**Trim Only (Rim or Vertical Rod)**

Quantity	Trim/Function	Finish	Hand
10	N655	606	RHR

**Vertical Rod Exit Device with Trim**

Quantity	Exit Device	Trim/Function	Finish		Hand	Optional Strike	Door Width	Height
			Trim	Device				
50	ED8400	PR610	626	689	RHR	S03	W048	H1000

**Contract/Detailed Order - Rim Exit Device with Trim**

Quantity	Keypad	Exit Device	Trim/Function	Finish		Hand	Door Thickness	Door Width	Optional Cylinder	Keying
				Trim	Device					
50	AA1	ED8200	N655	626	689	LHR	D200	W048	C6	VKC3

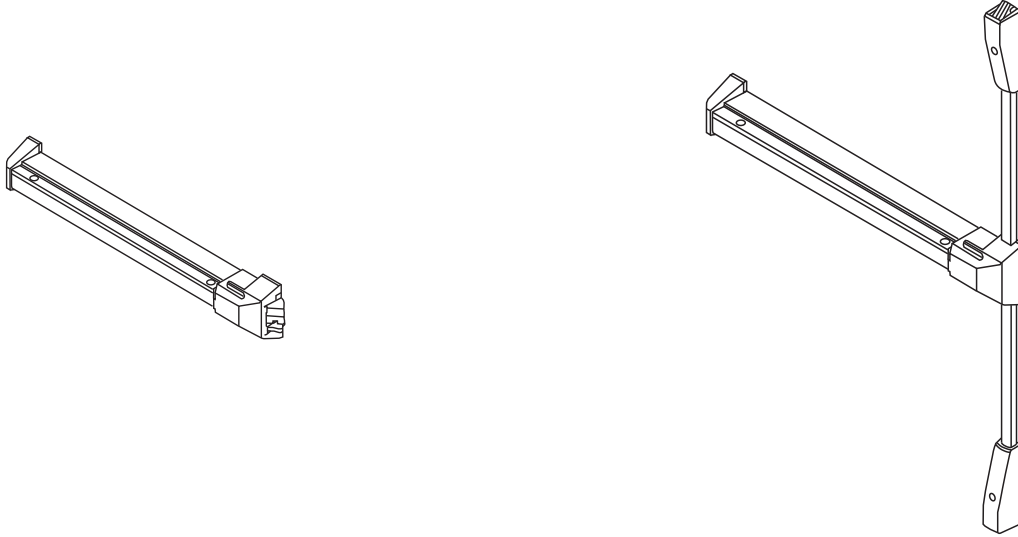

**30", 36" and 42" Exit Devices**

Includes device, strike(s) and screw pack. No cylinder or trim.

**Rim ED8200 Series**

Function	Description	Finish: 689, 690, 691
ED8200	Panic	\$518.00
ED8200B	1-1/2 Hour Fire Rated	\$590.00
ED8200A	3 Hour Fire Rated	\$671.00

**Vertical Rod ED8400 Series**

Function	Description	Finish: 689, 690, 691
ED8400	Panic	\$909.00
ED8400A	3 Hour Fire Rated	\$1,062.00

For exit trim prices see pages 304-306.

Caution: Be sure of your measurements. Exit devices are NOT returnable.

**ED8200/ED8400 Rim and Vertical Rod Trim**

Cylinder is not included, except where noted.

**Rose Trim Design: A6 Armstrong**



**Lever:** Die cast zinc  
Cylinder included

**Rose:** Wrought brass or bronze

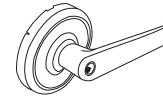

Function	Description	Finish: 613E, 626	Finish: 605, 606, 611, 612, 613, 619, 625, 722
A610	Passage	\$300.00	\$310.00
A650	Dummy	\$300.00	\$310.00
A655	Classroom	\$326.00	\$336.00
A657	Nightlatch <sup>1</sup>		
A659	Storeroom		

**Rose Trim Design: N6 Newport**



**Lever:** Die cast zinc  
Cylinder included

**Rose:** Wrought brass or bronze

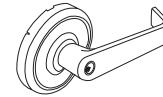

Function	Description	Finish: 613E, 626	Finish: 605, 606, 611, 612, 613, 619, 625, 722
N610	Passage	\$300.00	\$310.00
N650	Dummy	\$300.00	\$310.00
N655	Classroom	\$326.00	\$336.00
N657	Nightlatch <sup>1</sup>		
N659	Storeroom		

**Rose Trim Design: PR6 Princeton**



**Lever:** Die cast zinc  
Cylinder included

**Rose:** Wrought brass or bronze

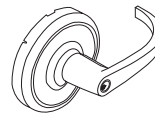

Function	Description	Finish: 613E, 626	Finish: 605, 606, 611, 612, 613, 619, 625, 722
PR610	Passage	\$300.00	\$310.00
PR650	Dummy	\$300.00	\$310.00
PR655	Classroom	\$326.00	\$336.00
PR657	Nightlatch <sup>1</sup>		
PR659	Storeroom		

Note:  
1. Not recommended for use with ED8400 and ED8400A surface vertical rod exit devices.



**ED8200/ED8400 Rim and Vertical Rod Trim**

Cylinder is not included, except where noted.

**Rose Trim Design: G10 Global**

**Knob:** Wrought  
Cylinder included

**Rose:** Wrought brass or bronze



Function	Description	Finish: 613E, 626	Finish: 605, 606, 611, 612, 613, 619, 625, 722
G1010	Passage	\$282.00	\$292.00
G1055	Classroom	\$308.00	\$318.00
G1050	Dummy	\$282.00	\$292.00
G1057	Nightlatch <sup>1</sup>	\$308.00	\$318.00
G1059	Storeroom	\$308.00	\$318.00

**Flat Plate Trim Design: F1 Flat Plate**

**Plate:** Steel

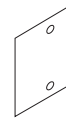

Function	Description	Finish: 613E, 626	Finish: 605, 606, 611, 612, 613, 619, 625, 722
F150	Dummy	\$80.00	\$90.00
F157	Nightlatch <sup>1</sup>		

**Pull Trim Design: P1 Z-Pull**



**Pull:** Extruded Aluminum

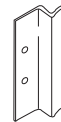

Function	Description	Finish: 613E, 626	Finish: 605, 606, 611, 612, 613, 619, 625, 722
P150	Dummy	\$242.00	\$252.00

Note:  
1. Not recommended for use with ED8400 and ED8400A surface vertical rod exit devices.

**ED8200/ED8400 Rim and Vertical Rod Trim**

Cylinder is not included, except where noted.

**Pull Trim Design: P2 Offset Pull**



**Pull:** Extruded Aluminum



Function	Description	Finish: 613E, 626	Finish: 605, 606, 611, 612, 613, 619, 625, 722
P250	Dummy	\$282.00	\$292.00
P257	Nightlatch <sup>1</sup>		

**Pull Trim Design: P8 Wing Pull**



**Pull:** Extruded Aluminum

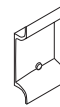

Function	Description	Finish: 689, 690, 691
P850	Dummy	\$82.00
P857	Nightlatch <sup>1</sup>	

**Trim Design: KO Key Only**

Note: Available with cylinder option only.  
Example: KO57 x 6P



Function	Description	Finish: 605, 606, 611, 612, 613, 619, 622, 625, 626, 722
KO57	Nightlatch <sup>1</sup>	See cylinder option Price, pg. 285

**Offset Pull Trim: P12, P13, P14**

Offset Pull Trim	Part Number	Finishes: 613E, 630	Finishes: 605, 606, 612, 613, 626, 629
P12	716F50M X Finish	\$258.00	\$272.00
P13	716F51M X Finish	\$316.00	\$330.00
P14	716F52M X Finish	\$223.00	\$237.00

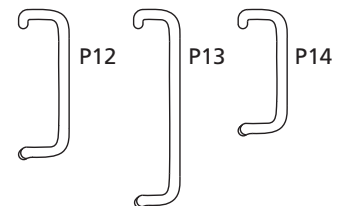

Note:  
1. Not recommended for use with ED8400 and ED8400A surface vertical rod exit devices.

**Cylinder Options\***
**Rim Cylinder Trim**

Description	Specify	Add or Deduct
Conventional 6-pin	6P**	Add \$83.00 per cylinder
Conventional 7-pin	7P	Add \$85.00 per cylinder
Access 3 Patented	AP	Add \$83.00 per cylinder
Access 3 Security	AS	Add \$132.00 per cylinder
Access 3 High Security, UL 437	AHS	Add \$152.00 per cylinder
Access 3 IC Patented	ACP	Add \$154.00 per cylinder
Access 3 IC Security	ACS	Add \$203.00 per cylinder
Access 3 IC High Security, UL 437	ACHS	Add \$223.00 per cylinder
Pyramid Security fixed core	PS	Add \$138.00 per cylinder
Pyramid Security IC	PCS	Add \$197.00 per cylinder
Pyramid High Security fixed core	PHS	Add \$167.00 per cylinder
Pyramid High Security IC	PCHS	Add \$235.00 per cylinder
Pyramid IC with temporary construction core	CTP	Add \$154.00 per cylinder
Pyramid IC with temporary disposable core	CTPD	Add \$83.00 per cylinder
Pyramid IC less core	CLP	Add \$83.00 per cylinder
Security	HS	Add \$189.00 per cylinder
Security IC	CHS	Add \$259.00 per cylinder
IC 6-pin	C6	Add \$154.00 per cylinder
IC 6-pin with temporary construction core (Red)	CT6R	Add \$154.00 per cylinder
IC 6-pin with temporary construction core (Blue)	CT6B	Add \$154.00 per cylinder
IC 6-pin with temporary construction core (Green)	CT6G	Add \$154.00 per cylinder
IC 6-Pin with temporary disposable core	CT6D	Add \$83.00 per cylinder
IC 6-pin less core	CL6***	Add \$83.00 per cylinder
SFIC 6-pin with Less Core	CLS6	Add \$83.00 per cylinder
IC 6-pin with SFIC disposable temporary core	CT6SD	Add \$83.00 per cylinder
IC 7-pin	C7	Add \$158.00 per cylinder
IC 7-pin with temporary construction core (Red)	CT7R	Add \$158.00 per cylinder
IC 7-pin with temporary construction core (Blue)	CT7B	Add \$158.00 per cylinder
IC 7-pin with temporary construction core (Green)	CT7G	Add \$158.00 per cylinder
IC 7-Pin with temporary disposable core	CT7D	Add \$85.00 per cylinder
IC 7-pin less core	CL7	Add \$85.00 per cylinder
SFIC 7-pin with Less Core	CLS7	Add \$85.00 per cylinder
IC 7-pin with SFIC disposable temporary core	CT7SD	Add \$85.00 per cylinder
Blockout function	BO	Add \$172.00 per cylinder

**Knob and Lever Trim**

Description	Specify	Add or Deduct
Conventional 6-pin	6P**	No Charge
Conventional 7-pin	7P	Add \$2.00 per cylinder
Access 3 Patented	AP	No Charge
Access 3 Security	AS	Add \$54.00 per cylinder
Access 3 High Security, UL 437	AHS	Add \$76.00 per cylinder
Access 3 IC Patented	ACP	Add \$71.00 per cylinder
Access 3 IC Security	ACS	Add \$120.00 per cylinder
Access 3 IC High Security, UL 437	ACHS	Add \$140.00 per cylinder
Pyramid Security fixed core	PS	Add \$55.00 per cylinder
Pyramid Security IC	PCS	Add \$124.00 per cylinder
Pyramid High Security fixed core	PHS	Add \$82.00 per cylinder
Pyramid High Security IC	PCHS	Add \$152.00 per cylinder
Security	HS	Add \$105.00 per cylinder
Security IC	CHS	Add \$176.00 per cylinder
IC 6-pin	C6	Add \$71.00 per cylinder
IC 6-pin with temporary construction core (Red)	CT6R	Add \$71.00 per cylinder
IC 6-pin with temporary construction core (Blue)	CT6B	Add \$71.00 per cylinder
IC 6-pin with temporary construction core (Green)	CT6G	Add \$71.00 per cylinder
IC 6-pin with temporary disposable core	CT6D	No Charge
IC 6-pin less core	CL6	No Charge
IC 7-pin	C7	Add \$73.00 per cylinder
IC 7-pin with temporary construction core (Red)	CT7R	Add \$73.00 per cylinder
IC 7-pin with temporary construction core (Blue)	CT7B	Add \$73.00 per cylinder
IC 7-pin with temporary construction core (Green)	CT7G	Add \$73.00 per cylinder
IC 7-pin with temporary disposable core	CT7D	No Charge
IC 7-pin less core	CL7	No Charge
Less (1) cylinder	LC	Deduct \$76.00 per cylinder

\*Optional alarm unit cylinder and trim are keyed alike unless otherwise specified.

If different keying is required, specify outside cylinder, then inside cylinder.

\*\*6P cylinder option is supplied in 6-pin, L4 keyway, 0-bitted with two nickel silver keys.

\*\*\* Not available for G10 trim

**Keying Options\***

Description	Specify	Add or Deduct
0-Bitted with 2 blank keys	(standard)	No Charge
Keyed random	KR	No Charge
Master Keyed (all cylinders except (8000, 8020, 8027 IC core)	specify keyset	Add \$16.00 per cylinder
Master Keyed Pyramid	specify keyset	Add \$16.00 per cylinder
Master Keyed Security (including IC cylinder and core)	specify keyset	Add \$16.00 per cylinder
Master Keyed 8000, 8020, 8027 IC core	specify keyset	No Charge
Master Keyed to customer bittings or sample key	specify keyset	Add \$16.00 per cylinder
Construction master keyed <sup>1,2</sup>	CMK	Add \$16.00 per cylinder
Visual key control (VKC)		
- No Stamping	VKC0	\$4.50
- Keys only	VKC1	No Charge
- Cylinders and Keys <sup>3</sup>	VKC2	\$8.00
- Cylinders only <sup>3</sup>	VKC3	\$8.00
Concealed key control (CKC)		
- CKC cylinders with VKC keys	CKC2	\$8.00
- CKC cylinders only <sup>3</sup>	CKC3	\$8.00
More than 2 keys per lock	KY# (e.g., KY6)	See page 66 - Cut Keys Section

**Notes:**

1. CMK Construction master keying charge is in addition to master keying charge.
  2. CMK construction master keying is not available in Pyramid or Security Series.
  3. VKC2, VKC3, CKC3 are not available in Pyramid or Security series.
- \*For key bows other than 10 and 90, specify 'KB' + bow number as Quick Code, e.g. KB12. No extra charge.

**Door Width Options**

Door Width	Specify	Add or Deduct
36"	(standard)	No Charge
30"	W030	
42"	W042	
48"	W048	Add \$35.00 per device

**Door Thickness Options**

Door Thickness	Specify	Add or Deduct
1-3/8" (G10, A6, N6, PR6 Trim only)	D138	No Charge
1-3/4"	(standard)	
2"	D200	
2-1/4"	D214	

**Door Height Options**

Door Height	Specify	Add or Deduct
7'6" (ED8400 devices)	(standard)	No Charge
8'0" (ED8400A devices)	(standard)	
10'0" (ED8400 devices only)	H1000	

**Miscellaneous Options**

Description	Specify	Add or Deduct
Less cylinder with tailpiece for Schlage® cylinder (A6, N6, PR6 designs only)	M06	No Charge
Lever to accept 6- or 7-pin Best-type IC core (SFIC) (N6, PR6 design only)	M08	No Charge
Lever to accept Sargent® cylinder (N6, PR6 design only)	M09	
Lever to accept <i>Schlage</i> IC core (N6, PR6 design only)	M69	
Knurling outside only (trim side)	M21	Add \$69.00 per lockset
Abrasive coat outside and inside (trim and device)	M23	Add \$85.00 per lockset
Abrasive coat inside only (device side)	M24	Add \$43.00 per lockset
Abrasive coat outside only (trim side)	M25	Add \$43.00 per lockset
Less dogging	M51	No Charge
Sex nuts and bolts (SNBs) <sup>1</sup>	M54	No Charge
Mullion Stabilizer	M57	Add \$62.00 per mullion
Shim kit (for vision light)		
- Rim device	M58	Add \$62.00 to device
- Vertical Rod device	M58	Add \$110.00 to device
Shim for 2-3/4" backset on doors with 1/2" stop	M59	Add \$30.00 to device
Exit alarm (for rim devices only)		
- Rim	M61	Add \$572.00 to device
- 1-1/2" hour fire rated rim	M61	Add \$578.00 to device
Exit alarm with delay (for rim devices only)		
- Rim	M62	Add \$601.00 to device
- 1-1/2" hour fire rated rim	M62	Add \$597.00 to device

Note:

1. Not available with D138 option.

**Strike Options\***

Description	Specify	Add or Deduct
Rim strike on ED8200, ED8200B devices	(standard)	No Charge
Fire rated Rim strike on ED8200A devices		
Rim x Vertical Rod strike for pairs of doors	S02	Add \$36.00 to device
Vertical Rod top strike on ED8400 device	(standard)	No Charge
Vertical Rod surface projecting bottom strike on ED8400 device		
Vertical Rod flush bottom strike on ED8400 device	S03	No Charge
Fire rated Vertical Rod top strike on ED8400A device	(standard)	No Charge
Fire rated Vertical Rod bottom strike on ED8400A device	(standard)	No Charge

\*To purchase strike separately, see catalog or parts manual for part no.

**Custom Laser Engraving- LASER**
**Laser engraving processing charge (all engraving types)**

- \$250 net per order. Charge will be applied to production order when placed.

**Single Vanity, Logo or Other (same engraving on all parts)**

- Lever - \$10 net add each
- Mortise Escutcheon - \$10 net add each
- HPSK Paddle - \$10 net add each

**Unique laser engraving (i.e. Room Number, Apartment Number, etc)**

- \$12 net add each (per piece)

**Alarm Kit**

**Ordering Example**

Quantity	Kit Number	Finish	Options
4	ED82AK	689	M62

Function	Description	Finish: 689, 690, 691
ED82AK	Cylinder is not included, M61 option	\$723.00
ED82AK	Cylinder is not included, M62 option	\$747.00

**Removable Mullion (Cylinder not included)**

Cylinder not included

**Ordering Example**

Quantity	Mullion Number
10	508

**Door Height Options**

Door Height	Specify	Price
Up to 8'0" 3 hour fire rated	508	\$893.00
Up to 7'2"	507	\$639.00
(SFIC) Up to 10'0" (ED8200 only)	510	\$766.00
Up to 7'0" Steel Mullion - Panic Rated	907	\$636.00
Up to 8'0" Steel Mullion - Panic Rated	908	\$646.00
Up to 10'0" (ED8200 only), Steel Mullion - Panic Rated	910	\$766.00
Up to 7'0", Steel Mullion - 3 Hour Fire Rated	907A	\$883.00
Up to 8'0", Steel Mullion - 3 Hour Fire Rated	908A	\$893.00

**Options**

Description	Specify	Price
Up to 7'0", key removable mullion, 1-1/2 Hour Fire Rated	907BKM <sup>1</sup>	\$1,360.00
Up to 8'0", key removable mullion, 1-1/2 Hour Fire Rated	908BKM <sup>1</sup>	\$1,370.00
Up to 10'0" (ED8200 only), key removable mullion, Panic Rated	910KM <sup>1</sup>	\$1,202.00
Door frame filler block for double rabbeted frames	M95	Add \$42.00 per mullion
Door frame angle bracket for aluminum frames	M96	Add \$42.00 per mullion

Note 1: Cylinder and collars not included, specify separately

**Mullions Cylinder Options**

Description	Specify	Add or Deduct
Conventional 6-pin	6P	Add \$83.00 per cylinder
Conventional 7-pin	7P	Add \$85.00 per cylinder
IC 6-pin	C6	Add \$154.00 per cylinder
IC 7-pin	C7	Add \$158.00 per cylinder
Pyramid High Security Fixed Core	PHS	Add \$167.00 per cylinder
Pyramid Security Fixed Core	PS	Add \$138.00 per cylinder
Pyramid High Security IC	PCHS	Add \$235.00 per cylinder
Pyramid Security IC	PCS	Add \$197.00 per cylinder
Security	HS	Add \$189.00 per cylinder
Security IC	CHS	Add \$259.00 per cylinder
IC 6-pin less core	CL6	Add \$83.00 per cylinder
IC 7-pin less core	CL7	Add \$85.00 per cylinder

**Standard Features**

**Handing**

Non-handed

**Spring Power**

DC3200 Series: Non-sized  
fully adjustable 1 thru 6.

**Degree of Opening**

Up to 180° opening standard for  
regular, top jamb and  
parallel arm mounting.

**Case Quantity**

4

**Case Weight**

42 lbs

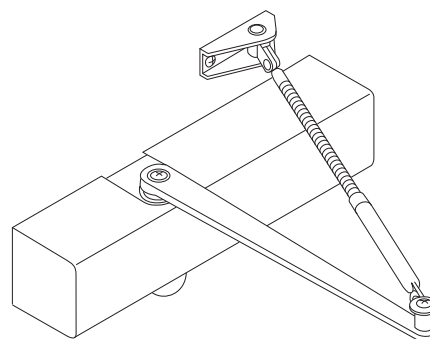

**Ordering Examples**

**Stock Order**

Quantity	Series/Mounting	Finish
48	DC3210	689

**Contract Order**

Quantity	Series/Mounting	Arm	Finish	Option
100	DC3210	A4	689	M54

**DC3200 Series**

Non-sized: full adjustability from sizes 1-6

Function	Description	Finish: 600, 689, 690, 691, 693, 696
DC3200	Regular arm	\$349.00
DC3210	Parallel arm	
DC3220	Top jamb	

DC3210 closers are tri-packed standard (for regular arm, top jamb or parallel arm mounting) unless specialty arm is requested.

**Arm Options**

Description	Specify Quick Code	Add or Deduct
Hold open arm	A1	Add \$61.00 per closer
Heavy-duty parallel arm with hold open	A2	Add \$78.00 per closer
Heavy-duty parallel arm	A3	Add \$39.00 per closer
Heavy-duty parallel arm with backstop	A4	Add \$72.00 per closer
Heavy-duty parallel arm with backstop & hold open	A5	Add \$136.00 per closer
Heavy-duty regular arm	A10	Add \$39.00 per closer

**Miscellaneous Options**

Description	Specify Quick Code	Add or Deduct
Sex nuts and bolts (SNB)	M54	No Charge
Backcheck intensity	(standard)	No Charge
Delayed Action	M71	Add \$38.00 per closer
Full ABS Cover	(standard)	No Charge
Corrosion protection	M75	Add \$38.00 per closer
Heavy-duty parallel arm flush transom bracket (499F30). Used with A2, A3, A4 & A5 arms)	M79	Add \$16.50 per closer

**Miscellaneous Brackets**

Description	Specify Quick Code	Add or Deduct
Parallel arm flush transom bracket	M82	Add \$25.00 per closer
Parallel arm offset bracket	M83	Add \$27.00 per closer
Mortise arm bracket for regular arm mounting	M84	Add \$27.00 per closer
Angle Support bracket	M85	Add \$27.00 per closer

**Door Thickness**

Description	Specify
1-3/4"	(standard)

**Drop Plates**

Closer Plates	Old Quick Ship #	Full Cover	List price
DC3210	M80	597F58	\$61.00
DC3220	M80	188F65	\$52.00

**Finish Options**

Description	Add or Deduct
600, 613E, 689, 690, 691, 693, 696	(standard)



**Standard Features**

**Handing**

Non-handed

**Spring Power**

DC5000 Series: sizes 1 thru 6 fully adjustable.

**Degree of Opening**

110° opening range for Push Side and Pull Side installations.

**Slide Track**

Standard

**Case Weight**

DC5230 8 lbs.

DC5240 8 lbs.



**Ordering Example**

**Stock Order**

Quantity	Series/Mounting	Finish
100	DC5230	689

**Contract Order**

Quantity	Series/Mounting	Arm	Finish
100	DC5240	A1	689

**DC5000 Series**

Non-sized: full adjustability from sizes 1-6

Function	Description	Finish: 600, 689, 690, 691, 693, 696
DC5230	Pull Side Track	\$518.00
DC5240	Push Side Track	

**Arm Options**

Description	Specify Quick Code	Add or Deduct
Hold open arm	A1	\$33.00

**Door Thickness**

Description	Specify
1-3/4"	(standard)

**Handing**

Description	Specify
Left Hand	LH
Right Hand	RH
Left Hand Reverse	RH
Right Hand Reverse	LH

**Finish Options**

Description	Add or Deduct
Painted finishes: 600, 689, 690, 691, 693, 696	(standard)

**Miscellaneous Options**

Description	Specify Quick Code	Add or Deduct
Sex nuts and bolts (SNB)	M54	No Charge

**Drop Plate**

Description	Part Number	Add or Deduct
Drop Plate (Push side)	754F80	\$42.00

**Standard Features**

**Handing**

Non-handed

**Spring Power**

DC6200 Series: sizes 1 thru 6 non-sized fully adjustable.

DC6400 Series: sizes 1 thru 6 half-size adjustability.

**Degree of Opening**

Up to full 180° opening standard for regular, top jamb and parallel arm applications.

**Case Quantity**

4

**Case Weight**

DC6200 42 lbs

DC6400 42 lbs

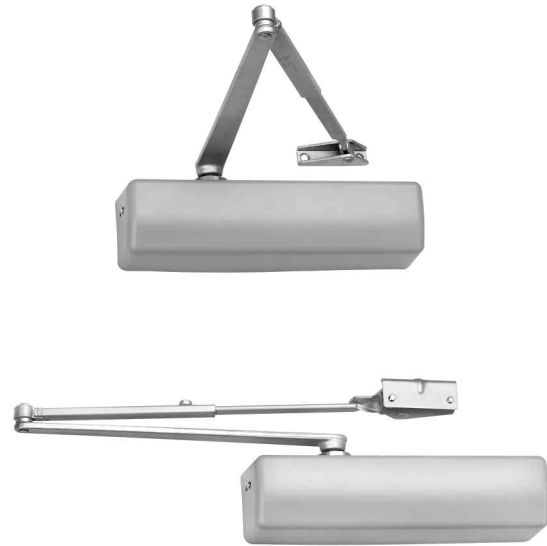

**Ordering Example**

**Stock Order**

Quantity	Series/Mounting	Finish
100	DC6210	689

**Contract Order**

Quantity	Series/Mounting	Arm	Finish	Door Thickness
100	DC6406	A6	689	D138

**DC6200 Series**

Non-sized: full adjustability from sizes 1-6

Function	Description	Finish: 600, 689, 690, 691, 693, 696
DC6200	Regular arm	\$394.00
DC6210	Parallel arm	
DC6220	Top jamb	
DC6230	Pull side track**	\$454.00
DC6240	Push side track	

DC6210 closers are tri-packed standard (for regular arm, top jamb or parallel arm mounting) unless specialty arm is requested.  
 \*\*Minimum 3" top jamb required.

**DC6400 Series**

Sized: 1/2-size adjustability

Function	Description	Finish: 600, 689, 690, 691, 693, 696	
DC6401	Regular arm	\$394.00	
DC6402			Size 1
DC6403			Size 2
DC6404			Size 3
DC6405			Size 4
DC6406			Size 5
DC6411	Parallel arm	\$394.00	
DC6412			Size 1
DC6413			Size 2
DC6414			Size 3
DC6415			Size 4
DC6416			Size 5
DC6421	Top jamb	\$394.00	
DC6422			Size 1
DC6423			Size 2
DC6424			Size 3
DC6425			Size 4
DC6426			Size 5
DC6433	Pull side track	\$454.00	
DC6434			Size 3
DC6435			Size 4
DC6436			Size 5
DC6443	Push side track	\$454.00	
DC6444			Size 3
DC6445			Size 4
DC6446			Size 5

Note: See page 317 for plated finishes.  
 DC641X closers are tri-packed standard (for regular arm, top jamb or parallel arm mounting) unless specialty arm is requested.

**Arm Options**

Description	Specify Quick Code	Add or Deduct
Hold open arm	A1	Add \$61.00 per closer
Heavy-duty parallel arm with hold open	A2	Add \$78.00 per closer
Heavy-duty parallel arm	A3	Add \$39.00 per closer
Heavy-duty parallel arm with backstop	A4	Add \$72.00 per closer
Heavy-duty parallel arm with backstop & hold open	A5	Add \$136.00 per closer
Deep reveal (3-1/4" - 7-1/4")	A6	No Charge
Deep reveal with hold open	A8	Add \$61.00 per closer
Heavy-duty regular arm	A10	Add \$39.00 per closer
Heavy-duty Unitrol®	A11*	Add \$197.00 per closer
Heavy-duty Unitrol® with hold open	A12*	Add \$259.00 per closer
Heavy-duty parallel arm with extra clearance	A13	Add \$31.00 per closer
Heavy-duty friction hold open arm	A14	Add \$77.00 per closer
Push side track with hold open	A1	Add \$61.00 per closer

\* Specify door width

**Door Width Options**

Description	Specify Quick Code	Add or Deduct
A11, A12 door width 28" - 32"	W28	No Charge
A11, A12 door width 33" - 41"	W33	
A11, A12 door width 42" - 48"	W42	

**Finish Options\***

Description	Add or Deduct
	<b>605, 606, 611, 612, 625, 626</b>
Painted finishes: 600, 613E, 689, 690, 691, 693, 696	(standard)
Plated finishes: specify 605, 606, 611, 612, 625, 626	
Regular, parallel, hold open:	
- Plated arm & cover*	Add \$502.00 per closer
- Plated cover (metal)	Add \$205.00 per closer
- Plated arm*	Add \$297.00 per closer
Heavy-Duty arms (A2, A3, A4, A5, A10, A11, A12, A13, A14) are not available plated. Track & arm for track-type closers are not available plated.	

\*For split finish of closer cover and arm, specify cover first, then arm finish; e.g. DC6200 x 625 x 689.

**Door Thickness**

Description	Specify
1- 3/4"	(standard)
2"	D200

**Handing**

Description	Specify
Left Hand	LH
Right Hand	RH
Left Hand Reverse	RH
Right Hand Reverse	LH

**Miscellaneous Options**

Description	Specify Quick Code	Add or Deduct
Torx® Screws	M04	Add \$30.00 per closer
Sex nuts and bolts (SNB)	M54	No Charge
Backcheck intensity and location valves	(standard)	No Charge
Delayed Action	M71	Add \$38.00 per closer
Full ABS Cover	(standard)	No Charge
Full Metal Cover	M73	Add \$16.00 per closer
Extreme temperature fluid	(standard)	No Charge
Corrosion protection	M75	Add \$38.00 per closer
Security package*	M87	A2-Arm - Add \$108.00 per closer
		A3 Arm - Add \$74.00 per closer
		A4 Arm - Add \$106.00 per closer
		A5 Arm - Add \$167.00 per closer
		A10 Arm - Add \$74.00 per closer

\*M87 includes full metal cover, Torx® fasteners and A2, A3, A4, A5, or A10 arm. Specify arm when ordering.

**Blade Stop Spacer**

Description	Specify Quick Code	Add or Deduct
1/2" spacer (597F92)	M77	Add \$20.00 per closer
5/8" spacer (597F93)	M78	Add \$32.00 per closer

**Miscellaneous Brackets**

Description	Specify Quick Code	Add or Deduct
HD PA flush transom bracket (used with all parallel arms except the Unicontrol®)	M79	Add \$33.00 per closer
Parallel arm flush transom bracket	M82	Add \$25.00 per closer
Parallel arm offset bracket	M83	Add \$27.00 per closer
Mortise arm bracket for regular arm mounting	M84	Add \$27.00 per closer
Angle support bracket	M85	Add \$27.00 per closer
Deep Reveal Reinforcement Kit	M103	Add \$27.00 per closer
Flush partition bracket	M104	Add \$22.00 per closer
Lead lined cover (metal cover only)	M108	Add \$18.00 per closer

**Drop Plates**

Closer Plates	Old Quick Ship #	Full Cover	List Price
DC6210, DC6410 (Parallel)	M80	597F58	\$61.00
DC6220, DC6420 (Top Jamb)	M80	188F65	\$52.00
DC6230, DC6430 (Pull Side)	M81	597F59	\$52.00
DC6240, DC6440 (Push Side)	M102	597F59	\$52.00

**Standard Features**

**Handing**

Non-handed

**Spring Power**

DC8200 Series: sizes 1 thru 6 non-sized fully adjustable.

DC8200 Series: sizes 1 thru 6 half-size adjustability.

**Degree of Opening**

Up to full 180° opening standard for regular, top jamb and parallel arm applications.

**Case Quantity**

4

**Case Weight**

DC8200 54 lbs



**Ordering Example**

**Stock Order**

Quantity	Series/Mounting	Finish
100	DC8210	689

**Contract Order**

Quantity	Series/Mounting	Arm	Finish	Door Thickness
100	DC8206	A6	689	D138

**DC8200 Series**

Non-sized full adjustability from sizes 1-6

Function	Description	Finish: 600, 689, 690, 691, 693, 696
DC8200	Regular arm	\$510.00
DC8210	Parallel arm	
DC8220	Top Jamb	
DC8230	Pull side track**	\$568.00
DC8240	Push side track	

DC8210 closers are tri-packed standard (for regular arm, top jamb or parallel arm mounting) unless specialty arm is requested.  
 \*Minimum 3" top jamb required.

**Factory Pre-Sized (available upon request)**

Function	Description		Finish: 600, 689, 690, 691, 693, 696
DC8201	Regular arm	Size 1	\$510.00
DC8202		Size 2	
DC8203		Size 3	
DC8204		Size 4	
DC8205		Size 5	
DC8206		Size 6	
DC8211	Parallel arm	Size 1	
DC8212		Size 2	
DC8213		Size 3	
DC8214		Size 4	
DC8215		Size 5	
DC8216		Size 6	
DC8221	Top Jamb	Size 1	
DC8222		Size 2	
DC8223		Size 3	
DC8224		Size 4	
DC8225		Size 5	
DC8226		Size 6	
DC8233	Pull side track	Size 3	\$568.00
DC8234		Size 4	
DC8235		Size 5	
DC8236		Size 6	
DC8243	Push side track	Size 3	
DC8244		Size 4	
DC8245		Size 5	
DC8246		Size 6	

DC821X closers are tri-packed standard (for regular arm, top jamb or parallel arm mounting) unless specialty arm is requested.



<b>Arm Options</b>		
<b>Description</b>	<b>Specify Quick Code</b>	<b>Add or Deduct</b>
Hold open arm	A1	Add \$61.00 per closer
Heavy-duty parallel arm with hold open	A2	Add \$78.00 per closer
Heavy-duty parallel arm	A3	Add \$39.00 per closer
Heavy-duty parallel arm with backstop	A4	Add \$72.00 per closer
Heavy-duty parallel arm with backstop & hold open	A5	Add \$136.00 per closer
Deep reveal (3-1/4" - 7-1/4")	A6	No Charge
Deep reveal with hold open	A8	Add \$61.00 per closer
Heavy-duty regular arm	A10	Add \$39.00 per closer
Unitrol® arm	A11*	Add \$197.00 per closer
Unitrol arm x hold open	A12*	Add \$259.00 per closer
Heavy-duty parallel arm with extra clearance	A13	Add \$31.00 per closer
Heavy-duty friction hold open	A14	Add \$77.00 per closer
Push side track with hold open	A1	Add \$61.00 per closer
*Specify door width		
<b>Door Width Options</b>		
<b>Description</b>	<b>Specify Quick Code</b>	<b>Add or Deduct</b>
A11, A12 - door width 28" - 32"	W28	No Charge
A11, A12 - door width 33" - 41"	W33	
A11, A12 - door width 42" - 48"	W42	
<b>Finish Options*</b>		
<b>Description</b>	<b>Add or Deduct</b>	
	<b>605, 606, 611, 612, 625, 626</b>	
Painted finishes: 600, 613E, 689, 690, 691, 693, 696	(standard)	
Plated finishes: specify 605, 606, 611, 612, 625, 626		
Regular, parallel, hold open:		
- Plated arm & cover*	Add \$502.00 per closer	
- Plated cover (metal)**	Add \$205.00 per closer	
- Plated arm*	Add \$297.00 per closer	
Heavy-Duty arms (A2, A3, A4, A5, A10, A11, A12, A13, A14) are not available plated. Track & arm for track-type closers are not available plated.		
*For split finish of closer cover and arm, specify cover first, then arm finish; e.g. DC6200 x 625 x 689. **Price of M73 option is not included.		

**Miscellaneous Options**

Description	Specify Quick Code	Add or Deduct
Torx® Screws	M04	Add \$30.00 per closer
Sex nuts and bolts (SNB)	M54	No Charge
Backcheck valve	(standard)	No Charge
Delayed Action	M71	Add \$38.00 per closer
Full ABS Cover	(standard)	No Charge
Full Metal Cover	M73	Add \$16.00 per closer
Extreme Temperature Fluid	(standard)	No Charge
Corrosion Protection	M75	Add \$38.00 per closer
Security Package*	M87	A2-Arm - Add \$108.00 per closer
		A3 Arm - Add \$74.00 per closer
		A4 Arm - Add \$106.00 per closer
		A5 Arm - Add \$167.00 per closer
		A10 Arm - Add \$74.00 per closer

\*M87 includes full metal cover, Torx® fasteners and A2, A3, A4, A5, A10 or A13. Specify arm when ordering

**Blade Stop Spacer**

Description	Specify Quick Code	Add or Deduct
1/2 " spacer (597F92)	M77	Add \$20.00 per closer
5/8 " spacer (597F93)	M78	Add \$32.00 per closer

**Miscellaneous Brackets**

Description	Specify Quick Code	Add or Deduct
HD PA flush transom bracket (used with all parallel arms except the Unitrol®)	M79	Add \$33.00 per closer
Parallel arm flush transom bracket	M82	Add \$25.00 per closer
Parallel arm offset bracket	M83	Add \$27.00 per closer
Mortise arm bracket for regular arm mounting	M84	Add \$27.00 per closer
Angle support bracket	M85	Add \$27.00 per closer
Deep reveal reinforcement kit	M103	Add \$27.00 per closer
Flush partition bracket (used with Unitrol® arm)	M104	Add \$22.00 per closer
Lead lined cover	M108	Add \$18.00 per closer

**Drop Plates**

Closer Series	Part Number	List Price
DC8200 (regular)	754F20	\$76.00
DC8200 (with concealed holder)	754F24	\$76.00
DC8210 (parallel)	754F25	\$76.00
DC8220 (top jamb)	754F24	\$76.00
DC8230 (pull side track)	754F20	\$76.00
DC8240 (push side track)	754F25	\$76.00

**Safeguard™ Door Controls**

Non-sized closer.  
689 and 690 Finishes.

**Ordering Example**

Quantity	Series/Mounting	Finish	Voltage
10	DC46920	689	24A

**DC46900 Series**

Model	Description	Price
DC46920	Pull side for RH and LH single doors and pair of doors	\$1,149.00
DC46925	Push side for LHR double egress doors	
DC46928	Pull side holder body with push side closer for reverse bevel doors	

**Voltage**

Description	Specify Quick Code
24VAC	24A
24VDC	24D
120VAC	120A

**Electromechanical Door Controls**

Sex nuts and bolts are furnished standard.  
 689 Finish.

**Ordering Example**

Quantity	Series/Mounting	Finish	Voltage	Options
24	DC62930	689	24A	M54

**DC62900 Series**

Model	Quick Code	Description	Finish: 600, 689, 690, 691, 693, 696
DC62930	ETD	Pull Side	Master Unit
DC62930	ETS		Slave Unit
DC62930	ET		Support Unit
DC62940	ETD	Push Side	Master Unit
DC62940	ETS		Slave Unit
DC62940	ET		Support Unit

**Miscellaneous Options**

Description	Specify Quick Code	Add or Deduct
Torx® machine screws	M04	Add \$30.00 per closer
Sex nuts and bolts		
- DC62930	(standard)	(standard)
- DC62940	(standard)	(standard)
Backcheck intensity valve	M70	Add \$27.00 per closer

**Voltage\***

Description	Specify Quick Code
24VAC	24A
24VDC	24D
120VAC	120A

A large empty rectangular box intended for handwritten notes.

# Parts Price List

Number 30  
Effective September 1, 2017



**PLUGS AND SHELLS**

**6-PIN PLUGS, BULK PACKS**

606, 626

PART NO.	DESCRIPTION	LIST PRICE
----------	-------------	------------

These packages are priced at a savings over individual plug prices. Keyway availability is limited to L4, D1, H1, 60, 59A1 and 981.

492K90	25 Pack for 1-1/8" Mortise	\$681.00
492K91	25 Pack for 3000 Rim	
492K92	50 Pack for CK4200, UT5200	\$1,362.00
610K48	50 Pack for CL3300	

**5- AND 6-PIN INDIVIDUAL PLUGS**

X CLASS	STANDARD	USED IN	LIST PRICE
---------	----------	---------	------------

487K10	121K10	1" Mortise (5-pin)	\$34.00
487K11	121K11	1-1/8" Mortise	
606K73	193K09	3-1/4" Mortise	\$61.00
606K74	193K10	3-1/2" Mortise	\$63.00
606K75	193K11	3-3/4" Mortise	\$65.00
487K38	197K51*	1001 Hotel Mortise	\$36.00
559K94	464K97	1004 Brink Mortise	
559K95	468K87	1005 Brink Mortise	
488K99	488K98	CK4200, UT5200 (.552") and 2000-051	\$34.00
564K53	574K05	CK4400, except below	
564K60	564K52	CK4429 Hotel, old tailpiece	\$43.00
564K59	579K14	CK4429, new tailpiece	
580K99	574K07	CK4455, CK4482, before 8/93	\$34.00
596K29	585K24	CL3300, CL3500, CL3600, CL3700, CL3800	
596K31	585K26	CL3329, CL3629 Hotel	\$45.00
489K49	186K75	2001-051 (1429/3433EM)	\$45.00
534K25	245K37	2100/2160 (large head)	\$43.00
612K90	444K87	2200-001 and -009	
612K91	444K89	2200-002	
612K88	444K94	2200-008	
612K93	444K88	2200-054	
612K94	523K21	2200-076	
488K84	253K66	3000 Rim Cylinder	\$34.00
610K46	146K80	4200-002 for AR Pull	\$43.00
	195K68	4266 for MR Exit Operators	\$51.00
334K01	334K00	8000-6 Interchangeable Core	\$34.00
n/a	378K18	Fox Police Rim Cyl. (5-pin)	\$51.00

**7-PIN PLUGS**

606, 626

X CLASS	STANDARD	USED IN	LIST PRICE
---------	----------	---------	------------

487K13	292K95	1-1/4" Mortise	\$36.00
487K15	292K96	1-3/8" Mortise	
487K17	292K97	1-1/2" Mortise	
487K19	292K98	1-3/4" Mortise	\$48.00
487K21	292K99	2" Mortise	\$50.00
606K76	293K00	2-1/4" Mortise	
606K77	293K01	2-1/2" Mortise	
606K78	293K02	2-3/4" Mortise	
606K79	293K03	3" Mortise	\$52.00
596K30	585K25	CL3300 Non-Hotel	\$44.00
596K32	585K27	CL3329 Hotel	\$48.00
488K85	253K67	3000-7 Rim Cylinder	\$36.00
416K08	416K07	8000-7 Core	\$44.00

**SECURITY PLUGS (USE IN SECURITY SHELLS ONLY)**

PART NO.	DESCRIPTION	LIST PRICE
----------	-------------	------------

407K63	1-1/8" Mortise	\$52.00
407K64	1-1/4" and 1012 (Blockout)	
415K73	1-3/8" Mortise	\$58.00
415K74	1-1/2" Mortise	
518K73	1-3/4" Mortise	\$68.00
518K74	2" Mortise	\$70.00
518K75	2-1/4" Mortise	
518K76	2-1/2" Mortise	\$72.00
518K77	2-3/4" Mortise	
409K12*	1011 Mortise Hotel	\$52.00
481K19	1014 Brink Mortise	\$54.00
481K28	1015 Brink Mortise	
408K45	CK4200, UT5200	\$48.00
585K46	CL3300 Non-Hotel	\$58.00
444K97	2210-001 and -009	\$58.00
444K98	2210-002	\$52.00
444K96	2210-008	\$58.00
444K99	2210-054	\$52.00
407K65	3010 Rim Cylinder	\$48.00
483K01	3012 Rim (Blockout)	\$56.00
446K68	8010 Interchangeable Core	\$44.00

**PYRAMID STANDARD PLUGS**

696K43	Used with 1020	†Order 10-	\$44.00
798K912 x Fin	Used with 1020 -112	†Order 10-	
696K45	Used with 3020	†Order 10-	
696K46	Used with 2020	†Order 10-	
696K48	Used with 2020	†Order 10-	
696K52	Used with 8020, 8027	†Order 10-	
715K14	Used with 2220	†Order 10-	\$46.00

**PYRAMID SECURITY PLUGS**

716K43	Used with 1027	†Order 10-	\$44.00
798K922 x Fin	Used with 1027 -112	†Order 10-	
716K45	Used with 3027	†Order 10-	
716K46	Used with 2027 KIL	†Order 10-	
716K48	Used with 2027 KIK	†Order 10-	
716K16	Used with 2227	†Order 10-	

**PYRAMID SIDE PIN PLUGS**

628K852 x Fin	Used with 1020-114	†Order 10-	\$46.00
628K972 x Fin	Used with 1020-112	†Order 10-	
628K872 x Fin	Used with 3020	†Order 10-	
628K902 x Fin	Used with 2020-052	†Order 10-	
628K882 x Fin	Used with 2020-03x	†Order 10-	
628K952 x Fin	Used with 2220	†Order 10-	
629K032 x Fin	Used with 8020, 8027	†Order 10-	\$46.00
628K992 x Fin	Used with 1027-114	†Order 10-	
630K472 x Fin	Used with 1027-112	†Order 10-	
629K002 x Fin	Used with 3027	†Order 10-	
629K022 x Fin	Used with 2027-052	†Order 10-	
629K012 x Fin	Used with 2027-03x	†Order 10-	
629K042 x Fin	Used with 2227	†Order 10-	\$48.00

**6-PIN LOADED SHELLS, BULK PACKS**

Finishes available for rim and mortise shells: 605, 606, 612, 613, 625, 626

493F76	25 Pack for 1000-118 Mortise	\$1,270.00
677F42	25 Pack for 1000-114 Mortise	
493F77	25 Pack for 3000 Rim	\$1,270.00
493F78	50 Pack for CK4200, UT5200	
610F49	50 Pack for CL3300, CL3700	

\*Not available in D1, D2, L1, L2, 752, 852 or A class keyways.  
†Sold only in multiples of the number indicated. Price is each.



**CYLINDER PARTS**

PART NO.	DESCRIPTION	LIST PRICE	SOLD IN MULT. OF	PART NO.	DESCRIPTION	LIST PRICE	SOLD IN MULT. OF			
<b>PYRAMID SHELLS</b>				<b>SECURITY MASTER PINS</b>						
695F042 x Fin	Used with 1020-114, 1027-114, 3020-058, 3027-058	\$62.00	10+	407T31-4097	2L	\$4.40	20+			
695F052 x Fin	Used with 3020, 3027 (Slotted)			407T32-4097	2R					
696F502 x Fin	Used with 8020, 8027			407T33-4097	2S					
696F472	Used with 2020, 2027 (KIL)	407T31-4125		3L						
696F499	Used with 2020, 2027 (KIK)	407T32-4125		3R						
715F152	Used with 2220, 2227	407T33-4125		3S						
<b>PYRAMID SHELLS - SIDE PINS</b>				407T31-4153	4L					
628F922 x Fin	Used with 8020, 8027	\$53.00		10+	407T32-4153	4R	\$4.10	20+		
629F062 x Fin	Used with 1020-114, 1027-114, 3020-058, 3027-058				407T33-4153	4S				
630F482 x Fin	Used with 1020-112, 1027-112				<b>SECURITY TOP PINS</b>					
628F912	Used with 2020-052, 2027-052	407T43-4193	Size 1 Long		\$4.10	20+				
628F892	Used with 2020, 2027 (Levers)	407T43-4158	Size 2 Short							
628F962	Used with 2220, 2227 (Competitors)	\$54.00	1		<b>BUMP-RESISTANT TOP SPOOL PINS (VIAL OF 100 PINS)</b>					
629F072 x Fin	Used with 3020, 3027 (Slotted)	\$53.00			628F10-7-171	Conventional			\$42.00	1
<b>PYRAMID SIDE PINS (VIAL OF 20 PINS)</b>					628F10-7-142	Pyramid A	\$92.00	1		
630F494	Pyramid Side Pins - Vial Of 20 Pins	\$16.00			628F10-7-236	Pyramid C	\$100.00	1		
<b>PYRAMID HIGH SECURITY PINS (VIAL OF 100 PINS)</b>					<b>SPRINGS AND SPRING COVERS</b>					
<b>TOP PINS</b>				172F21-7	Spring, interchangeable core	\$0.60	100+			
695F257031 - .031"	695F257173 - .173"	\$43.00		1	603F20-7	Spring, security and convent	\$0.20	100+		
695F257047 - .047"	695F257189 - .189"				026F75-7	Spring, hotel mortise blocking pin				
695F257063 - .063"	695F257204 - .204"				585F32-7	Spring, cylinder cap pin for 2000-034 type	\$0.30	100+		
695F257078 - .078"	695F257220 - .220"				314F98-7	Spring for 2001-034 indicator	\$0.20	100+		
695F257094 - .094"	695F257236 - .236"		217F42-2		Spring Cover, 5-pin brass	\$0.40	100+			
695F257110 - .110"	695F257252 - .252"		217F44-2		Spring Cover, 6-pin brass	\$0.40	100+			
695F257126 - .126"	695F257267 - .267"		314F88-7		Spring Cover, 6-pin stainless for most 2000 Series	\$0.60	50+			
695F257141 - .141"	695F257283 - .283"		217F43-2		Spring Cover, 7-pin brass	\$0.30	100+			
695F257157 - .157"	695F257299 - .299"		585F39-7		Spring Cover for 2000-034-7	\$1.30	10+			
<b>BOTTOM PINS</b>					171F46-8	Spring for 1100 Series Cyl. Head	\$0.20	100+		
695F247139 - .139"	695F247218 - .218"	\$36.00	1	697F507	Spring for all Pyramid Cyls	\$0.20	100+			
695F247155 - .155"	695F247234 - .234"			<b>ACCESS 3 PINS (VIAL OF 100 PINS)</b>						
695F247171 - .171"	695F247250 - .250"			<b>Bottom Pins (BP)</b>						
695F247187 - .187"	695F247265 - .265"			763F002243	Bottom AP-1	\$20.00	1			
695F247202 - .202"	695F247281 - .281"			763F002273	Bottom AP-2					
<b>PYRAMID SECURITY PINS (VIAL OF 100 PINS)</b>				763F002303	Bottom AP-3					
<b>TOP PINS</b>				763F002333	Bottom AP-4					
695F252031 - .031"	695F252173 - .173"			\$36.00	1			763F002363	Bottom AP-5	
695F252047 - .047"	695F252189 - .189"							763F002393	Bottom AP-6	
695F252063 - .063"	695F252204 - .204"					<b>Master Pins (MP)</b>				
695F252078 - .078"	695F252220 - .220"	763F012030	Master AP&AS-1			\$21.00	1			
695F252094 - .094"	695F252236 - .236"	763F012060	Master AP&AS-2							
695F252110 - .110"	695F252252 - .252"	763F012090	Master AP&AS-3							
695F252126 - .126"	695F252267 - .267"	763F012120	Master AP&AS-4							
695F252141 - .141"	695F252283 - .283"	763F012150	Master AP&AS-5							
695F252157 - .157"	695F252299 - .299"	<b>Top Pin - Bump Resistant</b>								
<b>BOTTOM PINS</b>						763F027120	Top-Spool AP-4	\$44.60	1	
695F244139 - .139"	695F244218 - .218"	763F027150	Top-Spool AP-5							
695F244155 - .155"	695F244234 - .234"	763F027180	Top-Spool AP-6							
695F244171 - .171"	695F244250 - .250"	763F027210	Top-Spool AP-7							
695F244187 - .187"	695F244265 - .265"	763F027240	Top-Spool AP-8							
695F244202 - .202"	695F244281 - .281"	763F027270	Top-Spool AP-9							
<b>PINS (SPECIFY SIZE WHERE APPROPRIATE)</b>				<b>Top Pin</b>						
553F48-4	Vial of 100 bottom pins (L Pins)	\$20.00	1	763F012180	Top AP-6	\$21.00	1			
553F50-2	Vial of 100 spool top pins (J Pins)			763F012210	Top AP/BU-7					
553F49-2	Vial of 100 top pins (= master & Bu) (M Pins)			763F012240	Top AP/BU-8					
546F97-8	Vial of 1500 construction balls	\$19.00	1	763F012270	Top AP/BU-9					
197F52-7	Pin, blocking of 1001, 1011 (hotel)	\$1.20	50+	<b>Build Up Pins (BU)</b>						
159F36-7	Ball bearing for wear resistance	\$0.40	100+	763F012300	BU-10	\$21.00	1			
<b>SECURITY BOTTOM PINS</b>				763F012330	BU-11					
407T41-4242	2L	\$4.20	20+	<b>CMK Wafer</b>						
407T42-4242	2R			763F072	CMK Wafer	\$38.80	1			
407T41-4270	3L			<b>TOP PINS</b>						
407T42-4270	3R			<b>Bottom Pins (BP)</b>						
407T41-4298	4L			<b>Master Pins (MP)</b>						
407T42-4298	4R			<b>Top Pin - Bump Resistant</b>						
407T41-4326	5L			<b>Top-Spool AP-4</b>						
407T42-4326	5R			<b>Top-Spool AP-5</b>						
407T41-4354	6L			<b>Top-Spool AP-6</b>						
407T42-4354	6R			<b>Top-Spool AP-7</b>						

†Sold only in multiples of the number indicated. Price is each.

**CYLINDER PARTS (CONT'D)**

PART NO.	DESCRIPTION	LIST PRICE	SOLD IN MULT. OF
<b>CAMS – CONVENTIONAL AND SECURITY</b>			
756F507	A01 Cloverleaf (was #11)	\$2.70	20†
147F77-2	A02 Straight, brass (was #1)	\$3.90	10†
147F77-8	A02 Straight, steel (was #1)	\$2.60	20†
111F55-8	A03 (was A)	\$3.20	10†
413F22-8	A04 (was J)	\$3.30	10†
105F70-2	A05 AR4070 (was B)	\$3.90	10†
626F077	A06	\$5.00	1
756F567	A07	\$6.20	
065F362	A62	\$15.50	
480F06-2	A91	\$5.10	5†
266F34-2	A92	\$4.10	10†
281F27-2	A93 (was C)	\$6.70	5†
406F43-8	Cam for O5 Exit trim	\$10.50	1
<b>CAMS - LFIC VERSION</b>			
756F507	A01 Cloverleaf (was #11)	\$2.70	
334F13-8	A02 Straight (was #1)		
362F42-8	A03 (was A)	\$4.30	10†
423F49-8	A04 (was J)		
362F50-2	A05 AR4070 (was B)	\$5.10	5†
626F077	A06	\$5.00	1
756F567	A07	\$6.20	
756F582	A62 Straight	\$16.30	1
294F05-2	A63 MR adaptation	\$5.10	5†
308F78-2	A64 MR adaptation	\$7.40	5†
526F66-2	A61 MR adaptation	\$8.40	5†
362F43-2	A93 (was C)	\$8.40	5†
<b>MASTER RING</b>			
562F40-2	A61 New Cloverleaf (locks after 5/93)	\$4.30	10†
065F36-2	A62 Straight (was 1A)	\$16.30	10†
121F01-2	A63 (was 1MR)	\$4.40	5†
135F19-2	A64 (was 2MR)	\$7.40	5†
025F72-2	A65 Old Cloverleaf (was 11A)	\$5.30	5†
<b>TAILPIECES</b>			
444F74-8	A21	\$1.90	20†
461F10-8	A22	\$2.40	10†
520F35-8	A23	\$4.30	10†
444F75-8	A24	\$2.40	10†
365F96-8	A38 (Fox square)	\$3.40	5†
329F99-8	A39 (Fox round)	\$5.60	5†
484F95-8	A41		
484F92-8	A42	\$2.10	10†
484F91-8	A43	\$1.60	20†
484F96-8	A44	\$3.90	10†
484F93-8	A45	\$2.60	10†
484F94-8	A46	\$3.70	10†
146F78-8	A47	\$13.90	1
585F33-7	For 2001-034-6	\$1.90	20†
585F35-8	For 2001-034-7	\$2.60	10†
622F29-8	For 2000-034-6		
596F89-8	For 2000-038	\$3.30	10†
622F30-8	For 2000-033-6, 2000-034-7		
489F02-8	For 2000-051	\$2.00	20†
682F298	For 2000-033-7	\$1.90	20†
186F74-8	For 2001-051	\$1.80	20†
622F328	For 2400-033		
682F398	For 2400-034	\$6.30	1
685F098	For 2400-037		
616F208	For 2400-039		
616F218	For 2400-039L	\$7.10	1
490F55-8	For 3000-138	\$3.10	10†
253F76-8	For 3000-200	\$2.00	20†
413F48-8	For 3000-200-V	\$3.00	10†
253F77-8	For 3000-312	\$2.00	20†
413F49-8	For 3000-312-V	\$3.30	10†
582F29-8	For 3080-114 for exit alarm options M61 & M62	\$3.70	10†
253F85-8	For 3080-178	\$3.60	10†
284F13-8	For 3080-318	\$2.90	10†
599F38-9	Kit for Sargent® in CL3600	\$9.40	1
601F22-9	Kit for Sargent in CL3400	\$9.90	1
622F32-8	For Schlage® cyl. in CL3400/CL3600	\$6.90	5†
715F108	P21		
715F118	P22	\$4.50	10†
715F128	P23		

PART NO.	DESCRIPTION	LIST PRICE	SOLD IN MULT. OF
<b>RETAINERS</b>			
173F79-8	.020" Plug Retainer-3300/5600,1400/4300	\$1.20	50†
368F91-8	.030" Plug Retainer-3000 and 3010 rim cylinders	\$1.80	20†
488F92-8	.032" Plug Retainer-2000-052, -044 and -051	\$1.50	20†
333F99-8	Plug Retainer, LFIC, CK4400, 2200-008, 2020 KIK	\$0.30	100†
334F23-8	Retainer, LFIC rim tailpiece	\$3.60	10†
365F95-8	Retainer, Fox Police rim cylinder	\$4.60	10†
250F08-8	Retainer for flex head cylinder	\$0.10	100†
680F64-5	Cap for 2000-033, 034	\$4.40	10†
585F31-2	Cap Pin for 2000-034	\$0.20	100†
219F88-8	Plug Retainer for 2060-052	\$0.30	100†
<b>LFIC THROW MEMBERS</b>			
715F892	CK4200, UT5200	\$3.80	1
320F44-2	CK4200, UT5200 Best® knob	\$5.70	1
622F728	CL3400, CL3600 Series packet (before 6/2000) straight	\$4.00	10†
682F91-8	CL3300, CL3600 series packet (after 6/2000) twisted	\$5.60	10†
379F805	Used with 1030-134, 1037-134	\$39.00	1
628F825	Used with 1030-114, 1037-114, 1030-138, 1037-138, 3030, 3037	\$12.00	1
628F835	Used with 1030-112, 1037-112	\$15.00	1
362F15-3	Padlock	\$8.00	10†
<b>OTHER LFIC PARTS</b>			
353F86-8	Inner cam for 1071 (hotel)	\$8.00	5†
446F57-2	Control Sleeve for 8000 core	\$14.00	5†
446F58-2	Control Sleeve for 8010 core	\$17.00	5†
438F42-8	Mortise Cylinder Cam Screw	\$0.30	100†
334F12-8	Mortise Cylinder Cam Plate		
622F69-8	Security disk for CL3400, CL3600	\$2.10	20†
607F91-9	Spacer for 6-pin Best type core		
<b>OTHER MASTER RING CYLINDER PARTS</b>			
522F93-2	Adapter Bushing for MR	\$71.00	1
135F10-8	Backplate, MR rim	\$4.00	10†
158F06-2	Cam Spacer for A61, A62, A65	\$1.50	20†
700F575	Thumbturn Hub for A61 MR cam	\$31.00	1
562F42-2	Kit, A61 cam / hub conversion	\$2.10	20†
488F10-8	Mortise Cylinder Set Screw Pkt	\$2.10	20†
354F19-8	Thumbturn disk, A64 cam	\$84.00	1
197F35-7	Wave Washer for collar	\$4.20	10†
<b>OTHER MORTISE/RIM CYLINDER PARTS</b>			
253F75-8	Backplate, rim cylinder	\$1.60	20†
438F41-8	Cam Screw	\$0.40	100†
488F08-8	Mortise Cylinder Set Screw Pkt	\$0.70	20†
021F68-8	Screw, rim cyl. mounting, 2-9/32"	\$0.70	20†
021F71-8	Screw, rim cyl. mounting, 3-1/8"	\$4.00	10†
197F34-7	Wave Washer for collar	\$3.00	20†
129F84-8	Cylinder Nut	\$7.00	1
310F48-8	Thumbturn Disk, A02 cam	\$35.00	1
<b>OTHER KNOB/LEVER CYLINDER PARTS</b>			
596F87-9	Obsolete by new design		
585F38-7	2001-034 Indicator fork	\$1.30	20†
585F37-7	2001-034 Stabilizer Pin	\$2.40	20†
314F99-7	2001-034-6 Indicator Pin	\$4.20	20†
585F40-7	2001-034-7 Indicator Pin	\$7.30	1
585F36-7	Tailpiece Anchor, 2001-034	\$2.00	20†
041F47-8	Key, hotel shut-out		50†
<b>PYRAMID CYLINDER PARTS</b>			
696F42	Blocking plate	\$4.20	20†
697F50	Tumbler spring	\$0.20	100†
217F43	Spring cover	\$0.40	100†
217F44	LFIC Spring cover	\$0.40	100†
696F51	Control sleeve	\$26.00	10†
628F932	Control sleeve - Used with 8020, 8027	\$28.00	10

†Sold only in multiples of the number indicated. Price is each.

**STANDARD DIAMETER CYLINDER COLLARS**

PART NO.	DESCRIPTION	LIST PRICE	SOLD IN MULT. OF	PART NO.	DESCRIPTION	LIST PRICE	SOLD IN MULT. OF
<b>STAMPED COLLARS</b>				<b>SOLID, RECESSED FOR CYLINDER HEAD (Cont'd)</b>			
253F97	<b>Spring collar</b> 605, 606, 612, 613, 618, 619, 622, 625, 626	\$6.80	10†	654F08	<b>.556" for ED4000/ED5000</b> 605, 606, 611, 612, 613, 622, 625, 626, 629, 630	\$22.50	1
428F66	<b>2-Piece (was 574 1/2, H)</b> 605, 606, 612, 613, 618, 619, 622, 625, 626	\$10.90	5† 1	609F37	<b>.650"</b> 605, 606, 611, 612, 613, 618, 619, 625, 626	\$32.50	1
549F52	<b>.219" Straight (was 154 1/2, H1)</b> 605, 606, 612, 613, 618, 619, 622, 625, 626	\$6.40	10†	609F38	<b>.850"</b> 605, 606, 611, 612, 613, 618, 619, 625, 626	\$32.50	1
605F43	<b>.350 Tapered spring collar</b> 605, 606, 612, 613, 618, 619, 622, 625, 626	\$6.70		134F05	<b>With lip, .510" ED7400, ED7800</b> 605, 606, 611, 612, 613, 618, 619, 622, 625, 626	\$32.50	1
<b>SPACER FOR FLEXIBLE HEAD CYLINDER</b>				<b>OTHER CYLINDER COLLARS</b>			
370F29	.125" (1/8")	\$34.00	1	416F39	<b>Security .172" (was 95)</b> 605, 606, 611, 612, 613, 618, 619, 625, 626	\$25.50	1
370F31	.250" (1/4")	\$35.00	1	303F25	<b>Solid .312" (was 571/J)</b> 605, 606, 611, 612, 613, 618, 619, 625, 626	\$31.50	1
252F82	.312" (5/16")	\$36.00	1	<b>RIM CYLINDER COLLARS</b>			
<b>SOLID, RECESSED FOR CYLINDER HEAD</b>				<b>Flush Mount (was 151/ R1290)</b>			
447F41	<b>.031" (was 575 1/4, 910)</b> 605, 606, 612, 613, 618, 619, 622, 625, 626	\$17.00	1	255F53	605, 606, 611, 612, 613, 618, 619, 622, 625, 626	\$13.90	10† 10† 1
270F15	<b>.156"</b> 605, 606, 612, 613, 618, 619, 622, 625, 626	\$21.50	1	422F88	<b>Surface Mount</b> 605, 606, 611, 612, 613, 618, 619, 622, 626, 625	\$15.20	5† 1
447F42	<b>.172" (was 575 3/8, 910-6)</b> 605, 606, 612, 613, 618, 619, 622, 625, 626	\$14.40	1				
610F01	<b>.221" (was 5574 3/4, C)</b> 605, 606, 612, 613, 618, 619, 622, 625, 626	\$28.50	1				
610F02	<b>.289" (was 5574 1/4, L)</b> 605, 606, 611, 612, 613, 618, 619, 625, 626	\$28.50	1				
654F07	<b>.356" for ED4000/ED5000</b> 605, 606, 611, 612, 613, 622, 625, 626, 629, 630	\$20.50	1				
447F43	<b>.375" (was 575 9/16, 910-9)</b> 605, 606, 611, 612, 613, 618, 619, 625, 626	\$17.80	1				
609F36	<b>.500"</b> 605, 606, 611, 612, 613, 618, 619, 625, 626	\$30.50	1				

†Sold only in multiples of the number indicated. Price is each.

**MASTER RING CYLINDER COLLARS**

PART NO.	DESCRIPTION	LIST PRICE	SOLD IN MULT. OF
<b>SOLID, RECESSED FOR CYLINDER HEAD</b>			
447F44	<b>.031" (was 576 1/4, MR910)</b>	\$20.40	1
	605, 606, 611, 612, 613, 618, 619, 625, 626		
447F45	<b>.172" (was 576 3/8, MR910-6)</b>	\$26.40	1
	605, 606, 611, 612, 613, 618, 619, 625, 626		
447F46	<b>.375" (was 576 9/16, MR910-9)</b>	\$30.40	1
	605, 606, 611, 612, 613, 618, 619, 625, 626		
<b>SPACERS FOR FLEXIBLE HEAD CYLINDERS</b>			
366F70	.090" tapered	\$8.90	5
370F33	.094"		
370F35	.281"	\$10.90	1
<b>RIM CYLINDER COLLARS</b>			
255F54	<b>(was 151 3/4, T)</b>	\$15.20	1
	605, 606, 612, 613, 619, 625, 626		

PART NO.	DESCRIPTION	LIST PRICE
<b>CYLINDER SERVICE TOOLS</b>		
See main price book		
<b>LOCKSET INSTALLATION TOOLS</b>		
574F15-8	CK4400 Series Knob Removal Tool	\$2.20
506F57	CK4400 Series Knob Cover Removal Tool	\$6.50
391F65-8	Knob Release Tool, CK4200, ML2200 †Order 100-	\$1.00

PART NO.	DESCRIPTION	LIST PRICE	PART NO.	DESCRIPTION	LIST PRICE
<b>ARMORED FRONT</b>			<b>AUXILIARY LATCH</b>		
Finish: 605, 606, 611, 612, 612, 613, 619, 625, 626, 629**, 630**			403F67-7	Auxiliary latch	\$15.00
<b>Deadbolt</b>			<b>AUXILIARY LATCH LEVER</b>		
079F00	Armored front, 1-1/4" standard	\$33.00	678F54-8	Auxiliary latch lever	\$5.00
079F02	Armored front, 1-1/8"		<b>Auxiliary Latch Lever Spring</b>		
<b>Deadbolt, latchbolt, aux. latch, toggle</b>			678F67-7	Auxiliary latch lever spring. †Order 100-	\$0.30
402F29	Armored front, 1-1/4" standard	\$33.00	<b>CAP</b>		
402F33	Armored front, 1-1/8"		700F278	Cap	\$22.00
<b>Deadbolt, latchbolt, auxiliary latch</b>			<b>CASE &amp; FRONT SA</b>		
402F30	Armored front, 1-1/4" standard	\$33.00	820F268 = 1-1/4" - STD		
402F34	Armored front, 1-1/8"		820F278 = 1-1/4" - ML2060/68		
<b>Deadbolt, latchbolt, toggle</b>			820F348 = 1-1/8" - STD		
402F31	Armored front, 1-1/4" standard	\$33.00	820F358 = 1-1/8" - ML2060/68		
402F35	Armored front, 1-1/8"		<b>CYLINDER LATCH LEVER SA</b>		
<b>Latchbolt, auxiliary latch, toggle</b>			701F748	Cylinder latch lever	\$1.20
681F31	Armored front, 1-1/4" standard	\$33.00	753F098	Cylinder latch lever (functions 72, 73, 75 )	
681F30	Armored front, 1-1/8"		<b>CYLINDER LATCH LEVER STOP</b>		
681F41	LHB, 1-1/4"		705F949	Cylinder latch lever stop	\$2.10
681F40	LHB, 1-1/16"		<b>CYLINDER SET SCREW BRACKET</b>		
<b>Blank Front</b>			402F73-8	Cylinder set screw bracket	\$5.30
720F43	Armored front, 1-1/4"	\$33.00	<b>DEADBOLT</b>		
720F46	Armored front, 1-1/16"		702F98-7	Deadbolt	\$39.00
<b>Filler Plate</b>			753F697	Deadbolt	
334F998	USP Filler, 8" x 1-1/4"	\$33.00	<b>DEADBOLT SPRING</b>		
<b>Deadbolt, latchbolt</b>			701F22-8	Deadbolt spring †Order 50-	\$1.20
423F54	Armored front, 1-1/4" standard	\$33.00	<b>DEADLOCKING LEVER</b>		
423F57	Armored front, 1-1/8"		602F19-8	Toggle Functions	\$3.70
<b>Latchbolt only</b>			624F48-8	Non-Toggle Functions	
423F55	Armored front, 1-1/4" standard	\$33.00	<b>DEADLOCKING LEVER SPRING</b>		
423F58	Armored front, 1-1/8"		700F90-7	Deadlocking lever spring	\$0.40
<b>Latchbolt, auxiliary latch</b>			<b>FIXED STOP</b>		
624F49	Armored front, 1-1/4" standard	\$33.00	684F55-9	Fixed stop	\$4.20
624F53	Armored front, 1-1/8"		<b>HUB ALIGNMENT BRACKET</b>		
<b>Deadbolt, latchbolt</b>			404F86-8	Hub alignment bracket	\$5.50
<b>Latchbolt, auxiliary latch</b>			<b>HUB ALIGNMENT BRACKET SCREW</b>		
<b>Deadbolt, latchbolt</b>			269F088	FHUM-PH #8-32 X 3/8" Screw †Order 20-	\$0.20
<b>Latchbolt, auxiliary latch</b>			<b>HUB LEVER</b>		
<b>Deadbolt, latchbolt</b>			820F008	Non Panic Egress	\$5.30
<b>Latchbolt, auxiliary latch</b>			820F148	Panic Egress	

†Sold only in multiples of the number indicated. Price is each.

\*\*618, 619 finish provided to match 629, 630.

PART NO.	DESCRIPTION	LIST PRICE
<b>HUB LEVER SPRING</b>		
820F048	Hub lever spring †Order 10-	\$1.90
<b>HUB SPACER</b>		
684F11-9	Hub spacer	\$1.90
<b>KNOB HUB</b>		
820F088	Cap Side	\$20.00
820F168	Case Side	
<b>LATCHBOLT</b>		
688F17-7	Latchbolt	\$45.00
<b>LATCH LEVER SPRING</b>		
700F95-7	Latch lever spring	\$0.80
<b>LEVER HUB</b>		
820F068	Cap side	\$12.00
820F078	Case side	
<b>LEVER RETURN SPRING</b>		
404F85-8	Lever return spring †Order 20-	\$1.50
<b>LOCKING LEVER</b>		
852F307	ML2017 Locking Lever	\$21.00
852F318	ML2017 Spring	
<b>OCCUPANCY INDICATOR, ML2029</b>		
<b>605, 606, 611, 612, 613, 618, 619, 625, 626</b>		
416F84	1-3/4" door, sectional	\$76.00
429F08	1-3/8" door, sectional	\$78.00
484F74	2-1/4" door, sectional	\$80.00
416F49	Escutcheon trim - 1-3/4" door	\$60.00
<b>RETAINING RING</b>		
436F17-7	Retaining ring †Order 100-	\$1.00
<b>SCREW PACKETS</b>		
<b>Finish: 606, 612, 613, 619</b>		
429F41	Mounting screw pack, standard	\$4.00
488F09	Mounting screw pack, MR option	\$7.00
465F57	Mounting screw pack, M04 (VR, HS)	\$23.00
616F12	Mounting screw pack, MR x M04	
<b>SPACER</b>		
466F22-9	Spacer	\$0.30
624F43-9	Spacer	
624F44-9	Spacer	
<b>SPACER SPRING</b>		
684F12-9	Spacer spring	\$0.20
<b>SPRINGS</b>		
403F56-8	Spring	\$8.00
688F01-7	Spring, kickoff	\$1.60
624F42-7	Spring	\$2.60

†Sold only in multiples of the number indicated. Price is each.

\*\*618, 619 finish provided to match 629, 630

PART NO.	DESCRIPTION	LIST PRICE
<b>STOP</b>		
684F05-5	Stop	\$4.00
<b>STOP CYLINDER LEVER</b>		
701F70-5	Stop cylinder lever	\$7.00
<b>STOP LEVERS</b>		
700F70-8	Stop lever	\$1.80
624F47-8	Stop lever	\$5.00
681F44-8	Stop lever	\$0.90
682F01-8	Stop lever	\$5.00
700F74-8	Stop lever	\$1.80
753F078	Stop lever	
<b>STOP SCREW</b>		
684F06-8	Stop screw	\$0.60
<b>STOP SPRING</b>		
685F38-7	Stop spring	\$0.50
703F997	Stop spring	\$1.40
790F047	Aux Stop Spring	
<b>THUMBTURN LEVER HUB</b>		
624F45-5	Thumbturn lever hub	\$8.00
<b>TURNPIECE HUB</b>		
711F395	Turnpiece hub	\$3.00
813F505	Turnpiece Hub	
<b>WROUGHT STRIKE BOX</b>		
120F76-8	ANSI wrought strike box	\$4.00
<b>STRIKES</b>		
<b>605, 606, 611, 612, 613, 619, 625, 626, 629**, 630**</b>		
<b>Latchbolt &amp; Deadbolt - Straight Lip</b>		
236L72014	7/8" Lip Length	\$32.00
236L72018	1-1/8" Lip Length	
236L72020	1-1/4" Lip Length	
236L72022	1-3/8" Lip Length	
236L72024	1-1/2" Lip Length	
236L72028	1-3/4" Lip Length	
236L72032	2" Lip Length	
236L72036	2-1/4" Lip Length	
236L72040	2-1/2" Lip Length	
236L72044	2-3/4" Lip Length	
236L72048	3" Lip Length	

PART NO.	DESCRIPTION	LIST PRICE	PART NO.	DESCRIPTION	LIST PRICE
<b>STRIKES (Cont'd)</b>			<b>STRIKE - MORTISE EXIT DEVICE - ED7600</b>		
<b>605, 606, 611, 612, 619, 613, 625, 626, 629**, 630**</b>			<b>689, 690, 691</b>		
<b>Latchbolt &amp; Deadbolt - Curved Lip (RH)</b>			405L138018	1-1/8" Lip Length LHR	<b>\$30.00</b>
340L60020	1-1/4" Lip Length RH	<b>\$36.00</b>	405L138020	1-1/4" Lip Length LHR	
340L60022	1-3/8" Lip Length RH		405L138022	1-3/8" Lip Length LHR	
340L60024	1-1/2" Lip Length RH		405L148018	1-1/8" Lip Length RHR	
340L60028	1-3/4" Lip Length RH		405L148020	1 1/4" Lip Length RHR	
340L60032	2" Lip Length RH		405L148022	1 3/8" Lip Length RHR	
340L60036	2-1/4" Lip Length RH		<b>STRIKE - OPEN BACK</b>		
340L60040	2-1/2" Lip Length RH		<b>605, 606, 611, 612, 613, 619, 625, 626, 629**, 630**</b>		
340L60044	2-3/4" Lip Length RH		411L63M016	1-3/4" Door RHR	<b>\$105.00</b>
340L60048	3" Lip Length RH		411L62M016	1-3/4" Door LHR	
<b>Latchbolt &amp; Deadbolt - Curved Lip (LH)</b>			411L63M018	2" Door RHR	<b>\$156.00</b>
340L61020	1-1/4" Lip Length LH	411L62M018	2" Door LHR		
340L61022	1-3/8" Lip Length LH	411L63M020	2 1/4" Door RHR		
340L61024	1-1/2" Lip Length LH	411L62M020	2-1/4" Door LHR		
340L61028	1-3/4" Lip Length LH	<b>STRIKE - RABBETED FRONT</b>			
340L61032	2" Lip Length LH	<b>605, 606, 611, 612, 613, 619, 625, 626, 629**, 630**</b>			
340L61036	2-1/4" Lip Length LH	318F64	Latch RH/LHR	<b>\$180.00</b>	
340L61040	2-1/2" Lip Length LH	318F65	Deadbolt RH/LHR		
340L61044	2-3/4" Lip Length LH	318F66	Latch and Deadbolt RH/LHR		
340L61048	3" Lip Length LH	318F67	Latch LH/RHR		
		318F68	Deadbolt LH/RHR		
		318F69	Latch and Deadbolt LH/RHR		

†Sold only in multiples of the number indicated. Price is each.

\*\*618, 619 finish provided to match 629, 630, except on 1-1/4" length curved lip strike

PART NO.	DESCRIPTION	LIST PRICE
<b>TRIM ALIGNMENT (ADAPTER) PACKETS</b>		
Finish: 605, 606, 611, 612, 613, 619, 625, 626, 629**, 630**		
<b>"P" Escutcheon</b>		
<b>Knob or Lever Trim</b>		
466F73	1-3/8" door	\$53.00
466F74	1-3/4" door	
466F75	2-1/4" door	\$61.00
<b>Half Working Trim</b>		
439F25	1-3/8" door	\$33.00
439F26	1-3/4" door	
439F27	2-1/4" door	
<b>Lever/Knob Half Dummy Trim</b>		
488F31	"P" Escutcheon	\$69.00
<b>Lever/Knob Full Dummy Trim</b>		
854F19	"P" Esc	
<b>"M" and "N" Escutcheons</b>		
<b>Regularly Furnished with Working Trim</b>		
466F50	1-3/8" door	\$45.00
466F51	1-3/4" door	\$49.00
466F52	2-1/4" door	\$51.00
<b>Half Working Trim</b>		
428F32	1-3/8" door	\$32.00
428F33	1-3/4" door	
428F34	2-1/4" door	
<b>Half Dummy Trim</b>		
854F27	Lever/Knob	\$58.00
<b>Full Dummy Trim</b>		
854F15	Lever/Knob	

PART NO.	DESCRIPTION	LIST PRICE
<b>TRIM ALIGNMENT (ADAPTER) PACKETS (Cont'd)</b>		
<b>Knob or Lever Trim Outside &amp; Blank Escutcheon Inside</b>		
466F45	1-3/8" door	\$37.00
466F46	1-3/4" door	
466F47	2-1/4" door	\$39.00
<b>Sectional Trim</b>		
<b>Regularly Furnished with Working Trim</b>		<b>No Finish</b>
466F40	1-3/8" door	\$24.00
466F41	1-3/4" door	\$22.00
466F42	2-1/4" door	\$24.00
<b>Half Working Trim</b>		
437F40	1-3/8" door	\$26.00
437F41	1-3/4" door	
437F42	2-1/4" door	
<b>Half Dummy Trim</b>		
438F38	Cast Knob*	\$67.00
854F23	Lever/Knob	\$41.00
511F51	Wrought Knob*	\$49.00
<b>Full Dummy Trim</b>		
854F11	Lever/Knob	\$13.00
<b>Inside Adapter Only - Lockbody*</b>		
427F06	Knob Half Working Trim	\$26.00
488F27	Lever/Knob Half Working Trim	\$48.00
<b>Adjustable Locknut Assembly*</b>		<b>No Finish</b>
482F37	Adjustable Locknut Assembly	\$7.00
<b>Adjusting Bolt for Half Lever Trim</b>		<b>No Finish</b>
483F34	1-3/8" door	\$7.00
483F35	1-3/4" door	\$8.00
483F36	2-1/4" door	\$9.00
<b>Adjusting Nut*</b>		<b>No Finish</b>
118F48-8	Adjusting Nut for Cast Knob	\$4.00
<b>Cylinder Set Screw Packet</b>		<b>No Finish</b>
488F08-8	Standard †Order 20	\$0.70
488F10-8	Master Ring	\$2.10
<b>Dowel Screw</b>		<b>No Finish</b>
483F30	for Inside Lever/Knob	\$3.00
<b>Emergency Key</b>		<b>Finish: 619</b>
605F42	for ML2020, ML2030, ML2060	\$5.00
<b>E-Ring</b>		<b>No Finish</b>
427F07-8	for working half trim adapter. †Order 100-	\$0.20

†Sold only in multiples of the number indicated. Price is each.

\*\*618, 619 finish provided to match 629, 630.

\*Discontinued product, only available as inventory allows.



PART NO.	DESCRIPTION	605, 606, 611, 612, 613, 613E, 618, 619, 625, 626, 629, 630, 722
<b>"R" ESCUTCHEON - CAST</b>		
<b>Blank</b>		
426F52	Outside	
545F79	Inside	
<b>For Cylinder only</b>		
427F45	Outside	
545F88	Inside	
<b>For Grip only</b>		
427F43	Outside	
545F87	Inside	
<b>For Cylinder &amp; Grip</b>		
427F39	Outside	
545F80	Inside	
<b>For Thumbturn Lever only</b>		
545F84	Inside-1-3/8" door	\$212.00
545F86	Inside-2-1/4" door	
545F85	Inside-1-3/4" door	
<b>For Thumbturn Lever &amp; Grip</b>		
545F81	Inside-1-3/8" door	
545F83	Inside-2-1/4" door	
545F82	Inside-1-3/4" door	
<b>For Grip &amp; Emergency Key</b>		
427F47	Outside	
<b>For Cylinder, Grip &amp; Indicator</b>		
427F37	Outside-1-3/4" door	
427F36	Outside-1-3/8" door	
485F74	Outside-2-1/4" door	
PART NO.	DESCRIPTION	605, 606, 611, 612, 613, 613E, 618, 619, 625, 626, 629, 630, 722
<b>"N" ESCUTCHEON - WROUGHT</b>		
<b>Blank</b>		
544F93	Inside or Outside	
<b>For Cylinder only</b>		
544F80	Inside or Outside	
<b>For Grip only</b>		
544F76	Inside or Outside	
<b>For Cylinder &amp; Grip</b>		
544F77	Inside or Outside	
<b>For Thumbturn Lever only</b>		
544F89	Inside-1-3/4" door	
544F92	Inside-1-3/8" door	
544F91	Inside-2-1/4" door	\$118.00
<b>For Thumbturn Lever &amp; Grip</b>		
544F85	Inside-1-3/4" door	
544F87	Inside-2-1/4" door	
544F88	Inside-1-3/8" door	
<b>For Grip &amp; Emergency Key</b>		
544F79	Outside	
<b>For Cylinder, Grip &amp; Indicator</b>		
544F82	Outside-1-3/8" door	
544F83	Outside-1-3/4" door	
544F84	Outside-2-1/4" door	

PART NO.	DESCRIPTION	605, 606, 611, 612, 613, 613E, 618, 619, 625, 626, 629, 630, 722
<b>"M" ESCUTCHEON - WROUGHT</b>		
<b>Blank</b>		
383F82	Outside	
545F45	Inside	
<b>For Cylinder only</b>		
488F07	Outside	
751F16	Outside - Master Ring	
545F00	Inside	
751F17	Inside - Master Ring	
<b>For Grip only</b>		
488F04	Outside	
544F95	Inside	
<b>For Cylinder &amp; Grip</b>		
488F05	Outside - Conventional	
557F29	Outside - Master Ring	
544F96	Inside - Conventional	\$118.00
377F80	Inside - Master Ring	
<b>For Thumbturn Lever only</b>		
545F42	Inside-1-3/8" door	
545F43	Inside-1-3/4" door	
545F44	Inside-2-1/4" door	
<b>For Thumbturn Lever &amp; Grip</b>		
544F97	Inside-1-3/8" door	
544F98	Inside-1-3/4" door	
544F99	Inside-2-1/4" door	
<b>For Grip &amp; Emergency Key</b>		
544F94	Outside	
<b>For Cylinder, Grip &amp; Indicator</b>		
433F48	Outside-1-3/8" door	
433F49	Outside-1-3/4" door	
484F90	Outside-2-1/4" door	
<b>"P" ESCUTCHEON - WROUGHT</b>		
<b>Blank</b>		
544F46	Inside	
384F11	Outside	
<b>For Cylinder only</b>		
488F03	Outside	\$118.00
544F43	Inside	

PART NO.	DESCRIPTION	605, 606, 611, 612, 613, 613E, 618, 619, 626, 625, 629, 630, 722
<b>"P" ESCUTCHEON - WROUGHT</b>		
<b>For Grip only</b>		
488F00	Outside	
544F39	Inside	
<b>For Cylinder &amp; Grip</b>		
488F01	Outside	
544F40	Inside	
<b>For Thumbturn Lever only</b>		
544F14	Inside-1-3/8" door	
544F44	Inside-2-1/4" door	
544F45	Inside-1-3/4" door	
<b>For Thumbturn Lever &amp; Grp</b>		
544F13	Inside-1-3/8" door	
544F41	Inside-2-1/4" door	
544F42	Inside-1-3/4" door	
<b>For Grp &amp; Emergency Key</b>		
544F38	Outside	
<b>For Cylinder, Grip &amp; Indicator</b>		
430F47	Outside-1-3/8" door	
435F00	Outside-1-3/4" door	
484F76	Outside-2-1/4" door	
		<b>\$118.00</b>

PART NO.	DESCRIPTION	613E, 630
<b>"V" ESCUTCHEON - CAST</b>		
<b>Blank</b>		
700F80	Outside	
700F40	Inside	
<b>For Cylinder only</b>		
700F83	Outside	
700F43	Inside	
<b>For Grip only</b>		
700F81	Outside	
700F41	Inside	
<b>For Cylinder &amp; Grip</b>		
700F82	Outside	
700F87	Outside - 7P & C6 (Use when collar is required)	
700F42	Inside	
700F47	Inside - 7P & C6 (Use when collar is required)	
<b>For Thumbturn Lever only</b>		
700F45	Inside	
<b>For Thumbturn Lever &amp; Grip</b>		
700F44	Inside	
<b>For Grp &amp; Emergency Key</b>		
700F84	Outside	
<b>For Cylinder, Grip &amp; Indicator</b>		
700F86	Outside	
700F46	Inside	
		<b>\$239.00</b>

PART NO.	DESCRIPTION	LIST PRICE
<b>Hex Wrench</b>		
		<b>No Finish</b>
264F69-8	Hex Wrench	<b>\$1.00</b>
<b>Key Plate Packet</b>		
438F90	Key Plate Packet: 605, 606, 611, 612, 613, 619, 625, 626, 629**, 630**	<b>\$24.00</b>

\*\*618, 619 finish provided to match 629, 630.

PART NO.	DESCRIPTION	605, 606, 611, 612, 613, 613E, 618, 619, 625, 626, 722			
<b>KNOB – WROUGHT AND CAST "YW" KNOB - WROUGHT*</b>					
<b>Inside Knob</b>					
502F62		\$162.00			
<b>Outside Knob &amp; Spindle Assembly</b>					
689F33	for 1-3/4" door	\$162.00			
689F30	for 1-3/8" door				
689F39	for 2-1/4" door				
<b>"GS" KNOB - CAST*</b>					
<b>Inside Knob</b>					
503F15		\$264.00			
<b>Outside Knob &amp; Spindle Assembly</b>					
689F37	for 2-1/4" door	\$264.00			
689F31	for 1-3/4" door				
689F28	for 1-3/8" door				
PART NO.	DESCRIPTION	605, 606, 611, 612, 613, 613E, 625, 626			
<b>"SS" KNOB - CAST</b>					
<b>Inside Knob</b>					
445F38		\$264.00			
<b>Outside Knob &amp; Spindle Assembly</b>					
445F43	for 1-3/4" door	\$264.00			
498F86	for 2" door				
498F87	for 2-1/4" door				
<b>"GW" KNOB - WROUGHT*</b>					
<b>Inside Knob</b>					
568F11		\$162.00			
<b>Outside Knob &amp; Spindle Assembly</b>					
689F60	for 1-3/4" door	\$162.00			
689F58	for 1-3/8" door				
689F62	for 2-1/4" door				
<b>"BW" KNOB - WROUGHT*</b>					
<b>Inside Knob</b>					
568F12		\$162.00			
<b>Outside Knob &amp; Spindle Assembly</b>					
502F10	for 1-3/4" door	\$162.00			
507F01	for 1-3/8" door				
511F73	for 2-1/4" door				
PART NO.	DESCRIPTION	605, 606, 611, 612, 613, 613E, 625, 626	PART NO.	DESCRIPTION	605, 606, 611, 612, 613, 613E, 625, 626
<b>"GR" KNOB - WROUGHT REINFORCED*</b>			<b>"GZ" KNOB - WROUGHT REINFORCED*</b>		
<b>Inside Knob</b>			<b>Inside Knob</b>		
502F27		\$172.00	854F04		\$172.00
<b>Outside Knob &amp; Spindle Assembly</b>			<b>Outside Knob &amp; Spindle Assembly</b>		
689F52	for 1-3/4" door	\$172.00	854F01	for 1-3/4" door	\$172.00
689F50	for 1-3/8" door				
689F54	for 2-1/4" door				
<b>"BR" KNOB - WROUGHT REINFORCED</b>			<b>"YZ" KNOB - WROUGHT REINFORCED</b>		
<b>Inside Knob</b>			<b>Inside Knob</b>		
502F29		\$172.00	854F09		\$172.00
<b>Outside Knob &amp; Spindle Assembly</b>			<b>Outside Knob &amp; Spindle Assembly</b>		
689F53	for 1-3/4" door	\$172.00	854F06	for 1-3/4" door	\$172.00
689F51	for 1-3/8" door				
689F55	for 2-1/4" door				
PART NO.	DESCRIPTION		LIST PRICE		
<b>Knob Release Tool</b>			<b>No Finish</b>		
391F65-8	Knob Release Tool		\$1.00		
<b>Knob Shank Adapter</b>			<b>No Finish</b>		
483F11-8	Knob Shank Adapter		\$7.00		
<b>Spring Clip</b>					
377F30-8	Spring Clip		\$2.00		

\*Discontinued product, only available as inventory allows.

PART NO.	DESCRIPTION	605, 606, 611, 612, 613, 613E, 618, 619, 625, 626, 629, 630, 722
<b>"AS" LEVER - CAST</b>		
<b>Inside Lever</b>		
670F37		
<b>Outside Lever &amp; Spindle Assembly</b>		
670F64	for 1-3/8" door	\$186.00
670F73	for 1-3/4" door	
671F09	for 2-1/4" door	
<b>"CS" LEVER - CAST</b>		
<b>Inside Lever</b>		
670F30		
<b>Outside Lever &amp; Spindle Assembly</b>		
670F57	for 1-3/8" door	\$186.00
670F66	for 1-3/4" door	
671F02	for 2-1/4" door	
<b>"DS" LEVER - CAST</b>		
<b>Inside Lever</b>		
670F32	LH/LHR	
670F31	RH/RHR	
<b>Outside Lever &amp; Spindle Assembly</b>		
670F59	for 1-3/8" door RH/RHR	\$186.00
670F68	for 1-3/4" door RH/RHR	
671F04	for 2-1/4" door RH/RHR	
670F58	for 1-3/8" door LH/LHR	
670F67	for 1-3/4" door LH/LHR	
671F03	for 2-1/4" door LH/LHR	
<b>"ES" LEVER - CAST</b>		
<b>Inside Lever</b>		
670F33		
<b>Outside Lever &amp; Spindle Assembly</b>		
670F60	for 1-3/8" door	\$186.00
670F69	for 1-3/4" door	
671F05	for 2-1/4" door	
<b>"LS" LEVER - CAST</b>		
<b>Inside Lever</b>		
670F34		
<b>Outside Lever &amp; Spindle Assembly</b>		
670F61	for 1-3/8" door	\$186.00
670F70	for 1-3/4" door	
671F06	for 2-1/4" door	
<b>"NS" LEVER - CAST</b>		
<b>Inside Lever</b>		
670F36		
<b>Outside Lever &amp; Spindle Assembly</b>		
670F63	for 1-3/8" door	\$186.00
670F72	for 1-3/4" door	
671F08	for 2-1/4" door	
<b>"PS" LEVER - CAST</b>		
<b>Inside Lever</b>		
670F38		
<b>Outside Lever &amp; Spindle Assembly</b>		
670F65	for 1-3/8" door	\$186.00
670F74	for 1-3/4" door	
671F10	for 2-1/4" door	
<b>"RS" LEVER - CAST</b>		
<b>Inside Lever</b>		
670F35		
<b>Outside Lever &amp; Spindle Assembly</b>		
670F62	for 1-3/8" door	\$186.00
670F71	for 1-3/4" door	
671F07	for 2-1/4" door	

PART NO.	DESCRIPTION	605, 606, 611, 612, 613, 613E, 618, 619, 625, 626, 629, 630, 722
<b>"LW" LEVER - WROUGHT</b>		
<b>Inside Lever</b>		
493F31		\$156.00
<b>Outside Lever &amp; Spindle Assembly</b>		
483F79	for 1-3/8" door	\$156.00
483F80	for 1-3/4" door	
483F81	for 2-1/4" door	
<b>"RW" LEVER - WROUGHT</b>		
<b>Inside Lever</b>		
493F34		\$156.00
<b>Outside Lever &amp; Spindle Assembly</b>		
483F82	for 1-3/8" door	\$156.00
483F83	for 1-3/4" door	
483F84	for 2-1/4" door	

PART NO.	DESCRIPTION	LIST PRICE
<b>NYLON BUSHING NO FINISH</b>		
698F22	Nylon Brushing †Order 100-	\$0.30
<b>ROSE PACKET</b>		
<b>Wrought Rose Packet- (Qty 2) 2-7/8" dia. (C)*</b>		
445F82	605, 606, 611, 612, 613, 613E, 618, 619, 625, 626, 722	\$68.00
<b>Wrought Rose Packet- (Qty 2) 3-1/2" dia. (D)*</b>		
445F83	605, 606, 611, 612, 613, 613E, 618, 619, 625, 626, 722	\$68.00
<b>Wrought Rose Packet- (Qty 2) 3" square (E)*</b>		
445F84	605, 606, 611, 612, 613, 613E, 618, 619, 625, 626, 722	\$68.00
<b>Cast Rose Packet - (Qty 2) 2-7/8" dia. (F)</b>		
447F24	605, 606, 611, 612, 613E, 618, 619, 625, 626, 629, 630, 722	\$166.00
<b>Cast Rose Packet- (Qty 2) 2-1/4" dia. (B)</b>		
447F25	605, 606, 611, 612, 613E, 618, 619, 625, 626, 629, 630, 722	\$86.00
<b>Wrought Rose Packet- (Qty 2) 2-1/4" dia. (A)</b>		
487F08	605, 606, 611, 612, 613E, 618, 619, 625, 626, 629, 630, 722	\$59.00
<b>Wrought Rose Packet- (Qty 2) 2-7/8" dia. (A)</b>		
	605, 606, 611, 612, 613E, 618, 619, 625, 626, 629, 630, 722	\$65.00

PART NO.	DESCRIPTION	LIST PRICE
<b>ROSE REINFORCEMENT PACKET NO FINISH</b>		
445F86-9	Rose Reinforcement Packet*	\$6.00
<b>SCREW PACKET</b>		
<b>605, 606, 611, 612, 613, 619, 625, 626, 629, 630</b>		
569F45	For M & P half dummy trim*	\$7.00
429F31-7	Screw Packet for "N" Surface Mounted Escutcheon	\$8.80
616F08-8	Lock mounting, spanner	\$9.20
584F46	Escutcheon for 1-3/4" door, spanner	\$5.00
384F03	Escutcheon for 2" - 2-1/4" door, spanner	
616F07-8	T20 Torx® bit	\$12.20
<b>SLEEVE</b>		
<b>605, 606, 611, 612, 613, 619, 625, 626, 629, 630</b>		
206F53	Sleeve for Cast Knob*	\$14.00
<b>SPACER NO FINISH</b>		
497F52-8	Spacer for Cast Knob*	\$3.00
<b>SPINDLES NO FINISH</b>		
<b>LxL, KxK, LxK, KxL Spindle</b>		
499F82-8	1-3/8" door	\$31.00
499F83-8	1-3/4" door	
499F84-8	2-1/4" door	

†Sold only in multiples of the number indicated. Price is each.

\*Discontinued product, only available as inventory allows.

PART NO.	DESCRIPTION	LIST PRICE	PART NO.	DESCRIPTION	LIST PRICE
<b>SPINDLE (Cont'd)</b>			<b>THUMBTURN LEVER PACKET</b>		
<b>(Knob x Knob) Spindle*</b>			<b>605, 606, 611, 612, 613, 625, 626, 629, 630</b>		
696F59-8	2-1/4" door	\$31.00	519F09	for 1-3/8" door	\$45.00
696F57-8	1-3/8" door	\$30.00	519F10	for 1-3/4" door	
696F58-8	1-3/4" door		519F11	for 2-1/4" door	
<b>SPINDLE FOR KNOB HALF TRIM*</b>			519F12	for up to 3" door	\$57.00
303F18	1-3/8" door	\$30.00	581F96	for up to 3-1/2" door	
303F19	1-3/4" door		303F20	2-1/4" door	\$57.00
<b>INSIDE SPINDLE FOR HALF LEVER TRIM*</b>			696F39	Blank Plate	\$57.00
680F34-8	1-3/8" door	\$17.00	<b>ERGONOMIC THUMBTURN LEVER PACKET FOR SECTIONAL TRIM</b>		
680F35-8	1-3/4" door	\$5.00	<b>605, 606, 611, 612, 613, 619, 625, 626, 629, 630</b>		
680F36-8	2-1/4" door	\$11.00	707F57	for 1-3/8" door	\$65.00
<b>HIGH SECURITY SPINDLE*</b>			707F58	for 1-3/4" to 2" doors	
445F41	1-3/4" door	\$27.00	707F59	for 2-1/4" door	
498F84	2" door	\$28.00	707F60	for up to 3" door	\$65.00
498F85	2-1/4" door	\$29.00	706F70	for up to 4" door	
<b>VANDAL RESISTANT SPINDLE &amp; SCREW PACK</b>			<b>ERGONOMIC THUMBTURN KIT FOR ESCUTCHEON TRIM</b>		
700F65	1-3/4" door	\$15.00	<b>605, 606, 611, 612, 613, 619, 625, 626, 629, 630</b>		
700F66	2" door		711F002	for up to 4" door (must be field cut to size)	\$65.00
700F67	2 -1/4" door		<b>WASHER FOR VANDAL RESISTANT TRIM</b>		
<b>THIMBLE PACKET</b>			700F37-8	Washer	\$2.60
432F86	<b>(Qty 2) for wrought escutcheon knob trim designs*</b>		<b>RETAINING RING FOR VANDAL RESISTANT TRIM</b>		
	605, 606, 611, 612, 613, 619, 625, 626, 629, 630	\$32.00	700F16-8	Retaining ring	\$1.00
445F85	<b>(Qty 2) for sectional knob trim designs*</b>		<b>LEVER SPINDLE SPRING FOR VANDAL RESISTANT TRIM</b>		
	605, 606, 611, 612, 613, 619, 625, 626	\$40.00	700F36-7	Lever spindle spring	\$1.00
<b>THIMBLE WRENCH NO FINISH</b>			PART NO.	DESCRIPTION	605, 606, 611, 612, 613, 613E, 618, 619, 625, 626, 629, 630, 722
300F68-8	Thimble Wrench	\$4.20	X FINISH		
<b>THROUGHBOLT PACKET</b>			<b>INDICATORS – KEYED FUNCTION (SECURE)</b>		
<b>605, 606, 611, 612, 613, 619, 625, 626, 629, 630</b>			720F21	for 1-3/8" (35mm) door	\$92.00
<b>"M" and "P" Escutcheons</b>			720F22	for 1-3/4" (44mm) – 2" (51mm) door	
433F76	1-3/8" door	\$7.00	720F24	for 2-1/4" (57mm) door	
433F77	1-3/4" door		720F25	for over 2-1/4" (57mm) door	
433F78	2-1/4" door		<b>INDICATORS – KEYED FUNCTION (VACANT)</b>		
<b>"R" Escutcheon</b>			741F21	for 1-3/8" door	\$92.00
439F33	1-3/8" door	\$7.00	741F22	for 1-3/4" to 2" doors	
439F34	1-3/4" door		741F23	for 2-1/4" door	
439F35	2-1/4" door		741F24	for up to 3" door	
<b>"T" Escutcheon (spanner head)*</b>			<b>INDICATORS – NON-KEYED FUNCTION (SECURE)</b>		
445F31-8	1-3/4" door	\$14.00	721F16	for 1-3/8" (35mm) door	\$110.00
498F92-8	2" to 2-1/4" door		721F17	for 1-3/4" (44mm) – 2" (51mm) door	
<b>*Note: Recommend Rose Reinforcement packet (445F86-9) with this item.</b>			721F18	for 2-1/4" (57mm) door	
<b>*Discontinued product, only available as inventory allows.</b>			721F19	for over 2-1/4" (57mm) door	
			<b>INDICATORS – NON-KEYED FUNCTION (VACANT)</b>		
			720F61	for 1-3/8" (35mm) door	\$110.00
			720F62	for 1-3/4" (44mm) – 2" (51mm) door	
			720F64	for 2-1/4" (57mm) door	
			720F65	for over 2-1/4" (57mm) door	
			<b>THUMBTURN INDICATOR</b>		
			723F69	for 1-3/8" (35mm) door	\$192.00
			723F26	for 1-3/4" (44mm) – 2" (51mm) door	
			791F59	for 2-1/4" (57mm) door	
			791F60	for over 2-1/4" (57mm) door	

**VINEYARD™ COLLECTION TRIM**

PART NO.	DESCRIPTION	605 , 606, 613E, 619, 625, 626
<b>INSIDE LEVERS</b>		
692F632	Frascati LH/LHR	\$244.00
692F642	Frascati RH/RHR	
692F662	Zinfandel LH/LHR	
692F672	Zinfandel RH/RHR	
692F652	Merlot	
<b>OUTSIDE LEVERS</b>		
692F762	Frascati for 1 3/4" door LH/LHR	\$244.00
692F752	Frascati for 1 3/4" door RH/RHR	
692F952	Zinfandel for 1 3/4" door LH/LHR	
692F942	Zinfandel for 1 3/4" door RH/RHR	
692F932	Merlot for 1 3/4" door	
<b>L ESCUTCHEON - CAST</b>		
<b>Blank</b>		
692F862	Inside	\$201.00
<b>For Cylinder Only</b>		
694F322	Inside	
694F522	Outside	
<b>For Grip Only</b>		
694F312	Inside	
694F442	Outside	
<b>For Cylinder &amp; Grip</b>		
694F332	Inside	
694F562	Outside	
<b>For Thumbturn Lever Only</b>		
694F352	Inside	
<b>For Thumbturn Lever &amp; Grip</b>		
694F392	Inside	
<b>For Grip &amp; Emergency Key</b>		
694F482	Outside	
<b>For Cylinder, Grip &amp; Indicator</b>		
694F602	Outside	
<b>For Grip x Plug Only</b>		
694F682	Outside	
<b>For Grip x Plug Only x Indicator</b>		
694F722	Outside	
<b>ROSES (PAIR)</b>		
694F802	G-Rose (All functions)	\$227.00

†Sold only in multiples of the number indicated. Price is each.

- Notes: 1. Kit contains lock parts only. Order knobs, spindles, escutcheons, cylinders and collars separately.  
 2. Kit contains armored front, specify finish.



### LOCKSET PARTS

PART NO.	DESCRIPTION	LIST PRICE
<b>LEVERS</b>		
790F215	NZD – Plain	\$78.00
790F225	NZD – Cylinder or Button	\$78.00
790F235	NZD – Emergency Key Hole	\$78.00
790F245	NZD – Intruder	\$78.00
790F335	NZD – SargentÆ Cylinder Cutout	\$78.00
790F345	NZD – Sargent Cylinder Cutout – Intruder	\$78.00
790F395	NZD – I/C Cylinder – 6 Pin	\$78.00
790F405	NZD – I/C Cylinder – 6 Pin Intruder	\$78.00
790F415	NZD – I/C Cylinder – 7 Pin	\$78.00
790F425	NZD – I/C Cylinder – 7 Pin Intruder	\$78.00
790F515	NZD – BestÆ Cylinder Cutout	\$78.00
790F525	NZD – Best Cylinder Cutout Intruder	\$78.00
790F575	NZD – SchlageÆ IC Cylinder Cutout	\$78.00
790F585	NZD – Schlage IC Cylinder Cutout – Intruder	\$78.00
780F215	NZD Security – Plain	\$78.00
780F225	NZD Security – Cylinder or Button	\$78.00
780F235	NZD Security – Emergency Key Hole	\$78.00
780F245	NZD Security – Intruder	\$78.00
780F335	NZD Security – Sargent Cylinder Cutout	\$78.00
780F345	NZD Security – Sargent Cylinder Cutout – Intruder	\$78.00
780F395	NZD Security – I/C Cylinder – 6 Pin	\$78.00
780F405	NZD Security – I/C Cylinder – 6 Pin Intruder	\$78.00
780F415	NZD Security – I/C Cylinder – 7 Pin	\$78.00
780F425	NZD Security – I/C Cylinder – 7 Pin Intruder	\$78.00
780F515	NZD Security – Best I/C Cylinder Cutout	\$78.00
780F525	NZD Security – Best I/C Cylinder Cutout Intruder	\$78.00
780F575	NZD Security – Schlage I/C Cylinder Cutout	\$78.00
780F585	NZD Security – Schlage I/C Cylinder Cutout – Intruder	\$78.00
776F215	AZD – Plain	\$78.00
776F225	AZD – Cylinder or Button	\$78.00
776F235	AZD – Emergency Key Hole	\$78.00
776F245	AZD – Intruder	\$78.00
776F335	AZD – SargentÆ Cylinder Cutout	\$78.00
776F345	AZD – Sargent Cylinder Cutout – Intruder	\$78.00
776F395	AZD – I/C Cylinder – 6 Pin	\$78.00
776F405	AZD – I/C Cylinder – 6 Pin Intruder	\$78.00
776F415	AZD – I/C Cylinder – 7 Pin	\$78.00
776F425	AZD – I/C Cylinder – 7 Pin Intruder	\$78.00
776F515	AZD – BestÆ Cylinder Cutout	\$78.00
776F525	AZD – Best Cylinder Cutout Intruder	\$78.00
776F575	AZD – SchlageÆ IC Cylinder Cutout	\$78.00
776F585	AZD – Schlage IC Cylinder Cutout – Intruder	\$78.00
777F215	AZD Security – Plain	\$78.00
777F225	AZD Security – Cylinder or Button	\$78.00
777F235	AZD Security – Emergency Key Hole	\$78.00
777F245	AZD Security – Intruder	\$78.00
777F335	AZD Security – Sargent Cylinder Cutout	\$78.00
777F345	AZD Security – Sargent Cylinder Cutout – Intruder	\$78.00
777F395	AZD Security – I/C Cylinder – 6 Pin	\$78.00
777F405	AZD Security – I/C Cylinder – 6 Pin Intruder	\$78.00
777F415	AZD Security – I/C Cylinder – 7 Pin	\$78.00
777F425	AZD Security – I/C Cylinder – 7 Pin Intruder	\$78.00
777F515	AZD Security – Best I/C Cylinder Cutout	\$78.00
777F525	AZD Security – Best I/C Cylinder Cutout Intruder	\$78.00
777F575	AZD Security – Schlage I/C Cylinder Cutout	\$78.00
777F585	AZD Security – Schlage I/C Cylinder Cutout – Intruder	\$78.00

PART NO.	DESCRIPTION	LIST PRICE
<b>LEVERS</b>		
778F215	PZD – Plain	\$78.00
778F225	PZD – Cylinder or Button	\$78.00
778F235	PZD – Emergency Key Hole	\$78.00
778F245	PZD – Intruder	\$78.00
778F335	PZD – SargentÆ Cylinder Cutout	\$78.00
778F345	PZD – Sargent Cylinder Cutout – Intruder	\$78.00
778F395	PZD – I/C Cylinder – 6 Pin	\$78.00
778F405	PZD – I/C Cylinder – 6 Pin Intruder	\$78.00
778F415	PZD – I/C Cylinder – 7 Pin	\$78.00
778F425	PZD – I/C Cylinder – 7 Pin Intruder	\$78.00
778F515	PZD – BestÆ Cylinder Cutout	\$78.00
778F525	PZD – Best Cylinder Cutout Intruder	\$78.00
778F575	PZD – SchlageÆ IC Cylinder Cutout	\$78.00
778F585	PZD – Schlage IC Cylinder Cutout – Intruder	\$78.00
779F215	PZD Security – Plain	\$78.00
779F225	PZD Security – Cylinder or Button	\$78.00
779F235	PZD Security – Emergency Key Hole	\$78.00
779F245	PZD Security – Intruder	\$78.00
779F335	PZD Security – Sargent Cylinder Cutout	\$78.00
779F345	PZD Security – Sargent Cylinder Cutout – Intruder	\$78.00
779F395	PZD Security – I/C Cylinder – 6 Pin	\$78.00
779F405	PZD Security – I/C Cylinder – 6 Pin Intruder	\$78.00
779F415	PZD Security – I/C Cylinder – 7 Pin	\$78.00
779F425	PZD Security – I/C Cylinder – 7 Pin Intruder	\$78.00
779F515	PZD Security – Best I/C Cylinder Cutout	\$78.00
779F525	PZD Security – Best I/C Cylinder Cutout Intruder	\$78.00
779F575	PZD Security – Schlage I/C Cylinder Cutout	\$78.00
779F585	PZD Security – Schlage I/C Cylinder Cutout – Intruder	\$78.00

PART NO.	DESCRIPTION	LIST PRICE
<b>ROSES</b>		
<b>D ROSE</b>		
678F252 Fin	626/613E	\$37.00
	605,606,611,612,613,618,619,625,722	\$42.00
<b>C ROSE</b>		
779F97 Fin	626/613E	\$37.00
	605,606,611,612,613,618,619,625,722	\$42.00
<b>ROSETTE FOR C &amp; K ROSE</b>		
778F90 Fin	626/613E	\$37.00
	605,606,611,612,613,618,619,625,722	\$42.00
<b>E ROSE</b>		
779F98 Fin	626/613E	\$39.00
	605,606,611,612,613,618,619,625,722	\$45.00
<b>ROSETTE FOR E ROSE</b>		
778F97 Fin	626/613E	\$42.00
	605,606,611,612,613,618,619,625,722	\$48.00
<b>K ROSE</b>		
779F99 Fin	626/613E	\$42.00
	605,606,611,612,613,618,619,625,722	\$48.00

# CL3100 Cylindrical Lock Series Vandal Resistant Lever Lockset

## LOCKSET PARTS

PART NO.	DESCRIPTION	LIST PRICE
<b>LATCH ASSEMBLIES</b>		
Standard		
780F81 Fin	10 Function	\$148.00
780F82 Fin	32, 40NT, 51, 52, 55, 57, 62, 72, and 80 Functions	
780F83 Fin	20 and 20H Functions	
780F84 Fin	29, 75, and 93 Functions	
780F85 Fin	61 Function	
3-3/4" Backset		
780F86 Fin	10 Function	\$138.00
780F87 Fin	32, 40NT, 51, 52, 55, 57, 62, 72, and 80 Functions	
780F88 Fin	20 and 20H Functions	
780F89 Fin	29, 75, and 93 Functions	
780F90 Fin	61 Function	
5" Backset		
780F91 Fin	10 Function	\$144.00
780F92 Fin	32, 40NT, 51, 52, 55, 57, 62, 72, and 80 Functions	
780F93 Fin	20 and 20H Functions	
780F94 Fin	29, 75, and 93 Functions	
780F95 Fin	61 Function	
3/4" Throw Fire Latch		
780F96 Fin	10, 51, 55, 57, 72, and 80 Functions	\$187.00

PART NO.	DESCRIPTION	LIST PRICE
<b>STRIKES</b>		
217L13	ANSI Curved Lip (Standard)	\$20.00
586L19	Curved Lip "T" Strike	\$22.00
120F768	ANSI Wrought Strike Box	\$9.00

PART NO.	DESCRIPTION	LIST PRICE
<b>SLEEVE ASSEMBLIES</b>		
STANDARD		
775F808	Outside Sleeve - 61 Function	\$151.00
776F002 Fin	Inside Sleeve - 51 Function	\$80.00
776F012 Fin	Inside Sleeve - 93 Function	\$80.00
776F022 Fin	Inside Sleeve - 61 Function	\$80.00
776F032 Fin	Inside Sleeve - 29 Function	\$151.00
776F042 Fin	Inside Sleeve - 20, 20H and 75 Functions	\$200.00
776F638	Outside Sleeve - 51, 57, 61, 72, and 93 Functions	\$151.00
776F648	Outside Sleeve - 40NT Function	\$80.00
776F658	Outside Sleeve - 32 Function	\$148.00
776F668	Outside Sleeve - 55 and 62 Functions	\$148.00
776F678	Outside Sleeve - 29 Function	\$151.00
776F688	Outside Sleeve - 52 and 75 Functions	\$170.00
776F698	Outside Sleeve - 20 and 20H Functions	\$130.00
776F708	Inside Sleeve - 10, 55, and 80 Functions Outside Sleeve - 10 Function	\$71.00
776F848	Inside Sleeve - 52 and 72 Functions	\$200.00
776F858	Inside Sleeve - 32 Function	\$144.00
776F868	Inside Sleeve - 62 Function	\$144.00
776F878	Inside Sleeve - 40NT and 57 Functions	\$71.00

PART NO.	DESCRIPTION	LIST PRICE
<b>SLEEVE ASSEMBLIES</b>		
INTERCHANGEABLE CORE		
775F818	Outside Sleeve - 61 Function	\$154.00
776F718	Outside Sleeve - 51, 57, 72, 93 Functions	\$154.00
776F728	Outside Sleeve - 32 Function	\$148.00
776F738	Outside Sleeve - 55, 62 Functions	\$148.00
776F748	Outside Sleeve - 52, 75 Functions	\$167.00
776F918	Inside Sleeve - 61, 75 Functions	\$154.00
776F928	Inside Sleeve - 52, 72 Functions	\$148.00
776F938	Inside Sleeve - 32 Function	\$148.00
776F948	Inside Sleeve - 62 Function	\$141.00
3/4" THROW FIRE LATCH - STANDARD		
779F638	Outside Sleeve - 51, 57, 72 Functions	\$144.00
779F648	Outside Sleeve - 55 Function	\$148.00
779F658	Inside Sleeve - 72 Function Inside Sleeve - 57 Function	\$74.00
779F728	Inside Sleeve - 72 Function	\$200.00
779F738	Inside Sleeve - 57 Function	\$71.00
779F748	Inside Sleeve - 51 Function	\$144.00
3/4" THROW FIRE LATCH - INTERCHANGEABLE CORE		
779F758	Inside Sleeve - 72 Function	\$151.00
M111 SLEEVE ASSEMBLIES - STANDARD		
775F828	Outside Sleeve - 61 Function	\$151.00
776F758	Outside Sleeve - 51, 57, 72, 93 Functions	\$151.00
776F768	Outside Sleeve - 32 Function	\$148.00
776F778	Outside Sleeve - 55, 62 Functions	\$148.00
776F788	Outside Sleeve - 29 Function	\$151.00
776F798	Outside Sleeve - 52, 75 Functions	\$170.00
776F958	Inside Sleeve - 52, 72 Functions	\$200.00
776F968	Inside Sleeve - 32 Function	\$144.00
776F978	Inside Sleeve - 62 Function	\$144.00
M111 SLEEVE ASSEMBLIES - INTERCHANGEABLE CORE		
775F838	Outside Sleeve - 61 Function	\$154.00
776F808	Outside Sleeve - 51, 57, 61, 72, 93 Functions	\$154.00
776F818	Outside Sleeve - 32 Function	\$148.00
776F828	Outside Sleeve - 55, 62 Functions	\$148.00
776F838	Outside Sleeve - 52, 75 Functions	\$167.00
776F988	Inside Sleeve - 52, 72 Functions	\$148.00
776F998	Inside Sleeve - 32 Function	\$148.00
777F208	Inside Sleeve - 62 Function	\$148.00

PART NO.	DESCRIPTION	LIST PRICE
<b>COLLARS</b>		
778F888	Inside Collar	\$6.00
778F898	Outside Collar	\$8.00

PART NO.	DESCRIPTION	LIST PRICE
<b>TAILPIECES</b>		
778F788	schlage conventional	\$17.00
780F658	Best style core	\$5.00
775F948	SARGENT	\$17.00
780F662	Schlage IC Core	\$23.00
780F648	Corbin Russwin LFIC	\$1.00
780F808	TAIL, CYLINDER, 20H	\$2.00

**LOCKSET PARTS**

PART NO.	DESCRIPTION	LIST PRICE
<b>MISCELLANEOUS</b>		
778F638	Collar/Rosette Installation Wrench	\$8.00
780F638	Allen Key Wrench	\$8.00
780F208	M111 Screwdriver	\$5.00
604F228 Fin	Screw Packet	\$17.00
775F908 Fin	Mounting Kit Packet (CL3150)	\$21.00
775F918 Fin	Mounting Kit Packet (CL3170)	\$21.00
753F598	Rose Installation Tool	\$7.00
778F868	Aligning Pin	\$1.00
779F787	Bearing Assembly	\$194.00
778F812	Emergency Release Cylinder	\$45.00
206F578	Screw, combo #8 PH	\$1.00
790F988	Inside Mounting Flange Assembly	\$112.00
790F998	Outside Mounting Flange Assembly	\$112.00
403F302 Fin	Cup Washer	\$3.00
305F318 Fin	Machine Screw 1/4-20 x 2-3/4	\$4.00
269F808	Countersunk Flat Head Screw 10-24x3/8" (1-3/4" Door)	\$1.00
778F968	Anchor Plate	\$1.00
778F91 Fin	Rosette Plug	\$38.00
790F988	FLANGE SA, MOUNTING I/S	\$112.00
790F998	FLANGE SA, MOUNTING O/S	\$112.00
220F718	SCREW, FHM-PH, 10-24X1/2	\$1.00
779F797	BEARING SA, D200	\$194.00
779F807	BEARING SA, M16	\$172.00
790F208	SCREW, FHM-PH, #4-40X1/2	\$4.00
679F818	Emergency Release Tool	\$1.10

### LOCKSET PARTS

PART NO.	DESCRIPTION	LIST PRICE	PART NO.	DESCRIPTION	LIST PRICE
<b>CHASSIS ASSEMBLY STANDARD</b>			<b>LEVERS 1-3/4" TO 2" DOORS (Cont'd)</b>		
785F008	for CL3310	\$154.00	596F825	NZD - SFIC (Best®) cylinder	\$103.00
785F118 Fin	for CL3320, CL3361	\$162.00	714F425	NZD - SFIC (Best®) cylinder CL3352 inside	
785F138 Fin	CL3320TO	\$156.00	690F975	NZD - Schlage® LFIC cylinder	
785F078 Fin	for CL3329	\$190.00	714F455	NZD - Schlage® LFIC cylinder CL3352 inside	\$99.00
785F068	for CL3332	\$184.00	563F885	AZD - Plain	
785F028 Fin	for CL3340	\$180.00	563F895	AZD - Cylinder or button	
785F038	for CL3340NT	\$164.00	714F005	AZD - CL3352 inside	\$101.00
785F018 Fin	CL3351, CL3357	\$164.00	563F905	AZD - Emergency key hole	
785F048	for CL3352, CL3355	\$190.00	585F705	AZD - LFIC cylinder - 6 pin	
785F148	for CL3359	\$164.00	714F305	AZD - LFIC cylinder - 6 pin CL3352 inside	\$101.00
785F058	for CL3362	\$184.00	600F425	AZD - LFIC cylinder - 7 pin	
785F088	for CL3372	\$172.00	714F315	AZD - LFIC cylinder - 7 pin CL3352 inside	
785F158 Fin	CL3375	\$152.00	695F075	AZD - Sargent® cylinder	\$101.00
785F088	for CL3380, CL3390	\$174.00	714F035	AZD - Sargent® cylinder CL3352 inside	
785F108	for CL3381, CL3391	\$172.00	578F435	NZD - Sargent cylinder	
785F378 Fin	CL3393	\$428.36	714F125	NZD - Sargent cylinder CL3352 inside	\$99.00
785F188	CL33903-12AD	\$428.36	799F505	PZD - plain	
785F168	CL33903-24AD	\$428.36	799F515	PZD - Cylinder or button	
785F198	CL33905-12AD	\$428.36	799F535	PZD - CL3352 inside	\$101.00
785F178	CL33905-24AD	\$196.00	799F525	PZD - Emergency key hole	
<b>CHASSIS ASSEMBLY, LFIC</b>			799F565	PZD - LFIC Cylinder - 6 pin	
785F298	for CL3361	\$202.00	799F575	PZD - LFIC Cylinder - 6 pin CL3352 inside	\$101.00
785F268 Fin	for CL3329	\$196.00	799F585	PZD - LFIC Cylinder - 7 pin	
785F258	for CL3332	\$180.00	799F595	PZD - LFIC Cylinder - 7 pin CL3352 inside	
785F218 Fin	for CL3351, CL3357, CL3393	\$196.00	799F805	PZD - SFIC (Best®) cylinder	\$103.00
785F238	for CL3352	\$180.00	799F815	PZD - SFIC (Best®) cylinder CL3352 inside	
785F228	for CL3355	\$196.00	799F825	PZD - Schlage® LFIC cylinder	
785F308	for CL3359	\$196.00	799F835	PZD - Schlage® LFIC cylinder CL3352 inside	\$101.00
785F248	for CL3362	\$175.00	799F545	PZD - Sargent® cylinder	
785F278	for CL3372	\$188.00	799F555	PZD - Sargent® cylinder CL3352 inside	
785F318 Fin	CL3375	\$175.00	712F205	FZD - LH plain	\$101.00
785F288	for CL3381, CL3391	\$438.36	712F215	FZD - LH cylinder or button	
785F388 Fin	CL3393	\$438.36	712F385	FZD - LH CL3352 inside	
785F348	CL33903-12AD	\$438.36	712F225	FZD - LH emergency key hole	\$103.00
785F328	CL33903-24AD	\$438.36	715F245	FZD - LH LFIC cylinder - 6 pin	
785F358	CL33905-12AD	\$438.36	712F405	FZD - LH LFIC cylinder - 6 pin CL3352 inside	
785F338	CL33905-24AD	\$438.36	714F255	FZD - LH LFIC cylinder - 7 pin	\$105.00
<b>CYLINDER PARTS</b>			712F415	FZD - LH LFIC cylinder - 7 pin CL3352 inside	
622F308	Tailpiece 6-pin	\$2.00	712F265	FZD - LH SFIC (Best®) cylinder	
682F298	Tailpiece 7-pin	\$5.60	712F425	FZD - LH SFIC (Best®) cylinder CL3352 inside	\$103.00
631F248	Corbin Russwin LFIC core kit	\$5.60	712F275	FZD - LH Schlage® LFIC cylinder	
682F958	SFIC (Best®) tailpiece kit	\$17.40	712F435	FZD - LH Schlage® LFIC cylinder CL3352 inside	
682F969	Sargent® tailpiece kit	\$23.00	712F235	FZD - LH Sargent® cylinder	\$101.00
697F942	Schlage® LFIC tailpiece kit	\$6.30	712F395	FZD - LH Sargent® cylinder CL3352 inside	
682F398	Schlage® tailpiece kit	\$33.00	712F505	FZD - RH plain	
<b>HOUSING ASSEMBLIES</b>			712F515	FZD - RH cylinder or button	\$101.00
783F208	Spring housing O/S	\$28.00	712F685	FZD - RH CL3352 inside	
783F308	Spring housing I/S 1 3/4" - 2"	\$28.00	712F525	FZD - RH emergency key hole	
783F408	Spring housing I/S 2 1/4"	\$108.00	712F545	FZD - RH LFIC cylinder - 6 pin	\$103.00
686F858	Dummy housing I/S	\$94.40	712F705	FZD - RH LFIC cylinder - 6 pin CL3352 inside	
686F868	Dummy housing O/S	\$99.00	712F555	FZD - RH LFIC cylinder - 7 pin	
<b>LEVERS 1-3/4" TO 2" DOORS</b>			712F715	FZD - RH LFIC cylinder - 7 pin CL3352 inside	\$105.00
563F945	NZD - Plain	\$99.00	712F565	FZD - RH SFIC (Best®) cylinder	
563F955	NZD - Cylinder button		712F725	FZD - RH SFIC (Best®) cylinder CL3352 inside	
714F065	NZD - CL3352 inside		712F575	FZD Schlage® LFIC cylinder	
563F965	NZD - Emergency key hole	\$101.00	712F735	FZD Schlage® LFIC cylinder CL3352 inside	
585F715	NZD - LFIC cylinder - 6 pin		712F535	FDZ - RH Sargent® cylinder	
714F365	NZD - LFIC cylinder - 6 pin CL3352 inside		712F695	FDZ - RH Sargent® cylinder CL3352 inside	
600F415	NZD - LFIC cylinder - 7 pin	\$103.00			
714F375	NZD - LFIC cylinder - 7 pin CL3352 inside				

### LOCKSET PARTS

PART NO.	DESCRIPTION	LIST PRICE	PART NO.	DESCRIPTION	LIST PRICE
<b>LEVERS 2 1/4" DOORS</b>			<b>LEVERS 2 1/4" DOORS (Cont'd)</b>		
684F825	NZD - Plain	\$99.00	712F335	FZD - LH Sargent® cylinder	\$103.00
684F835	NZD - Cylinder or button		712F455	FZD - LH Sargent® cylinder CL3352 inside	
714F215	NZD - CL3352 inside		712F605	FZD - RH plain	\$101.00
684F845	NZD - Emergency key hole		712F615	FZD - RH cylinder or button	
684F865	NZD - LFIC cylinder - 6 pin	712F745	FZD - RH CL3352 inside		
714F545	NZD - LFIC cylinder - 6 pin CL3352 inside	712F625	FZD - RH emergency key hole	\$103.00	
685F875	NZD - LFIC cylinder - 7 pin	712F645	FZD - RH LFIC cylinder - 6 pin		
714F555	NZD - LFIC cylinder - 7 pin CL3352 inside	712F765	FZD - RH LFIC cylinder - 6 pin CL3352 inside		
684F885	NZD - SFIC (Best®) cylinder	712F655	FZD - RH LFIC cylinder - 7 pin		\$105.00
714F605	NZD - SFIC (Best®) cylinder CL3352 inside	712F775	FZD - RH LFIC cylinder - 7 pin CL3352 inside		
690F985	NZD - Schlage® LFIC cylinder	712F665	FZD - RH SFIC (Best®) cylinder		
714F635	NZD - Schlage® LFIC cylinder CL3352 inside	712F785	FZD - RH SFIC (Best®) cylinder CL3352 inside	\$103.00	
684F855	NZD - Sargent® cylinder	712F675	FZD - RH Schlage® LFIC cylinder		
714F275	NZD - Sargent® cylinder CL3352 inside	712F795	FZD - RH Schlage® LFIC cylinder CL3352 inside		
684F775	AZD - Plain	712F635	FZD - RH Sargent® cylinder		\$105.00
684F785	AZD - Cylinder or button	712F755	FZD - RH Sargent® cylinder CL3352 inside		
714F155	AZD - CL3352 inside	<b>EMERGENCY RELEASE TOOL</b>			
684F795	AZD - Emergency key hole	679F818	Emergency Release Tool (CL3320)	\$1.20	
684F805	AZD - LFIC cylinder - 6 pin	601F829	Emergency Release Label (CL3320)		
714F485	AZD - LFIC cylinder - 6 pin CL3352 inside	<b>LEVER INSERT</b>			
684F815	AZD - LFIC cylinder - 7 pin	585F729	Lever insert (black)	\$0.30	
714F495	AZD - LFIC cylinder - 7 pin CL3352 inside	<b>LATCH ASSEMBLY</b>			
697F995	AZD - Sargent® cylinder	<b>2 3/4" Backsets</b>			
714F185	AZD - Sargent® cylinder CL3352 inside	586F16	Plain, square corner	\$71.00	
799F605	PZD - Plain	596F66	Plain, round corner		
799F615	PZD - Cylinder or button	586F17	Deadlocking square corner	\$79.00	
799F635	PZD - CL3352 inside	596F67	Deadlocking round corner		
799F625	PZD - Emergency key hole	586F18	Throw-Off square corner		
799F665	PZD - LFIC cylinder - 6 pin	596F68	Throw-Off round corner		
799F675	PZD - LFIC cylinder - 6 pin CL3352 inside	601F69	3/4" Through deadlocking fire latch square corner	\$101.00	
799F685	PZD - LFIC cylinder - 7 pin	<b>3 3/4" Backsets</b>			
799F695	PZD - LFIC cylinder - 7 pin CL3352 inside	586F80	Plain, square corner	\$135.00	
799F845	PZD - SFIC (Best®) cylinder	586F86	Plain, round corner		
799F855	PZD - SFIC (Best®) cylinder CL3352 inside	586F81	Deadlocking square corner	\$143.00	
799F865	PZD - Schlage® LFIC cylinder	586F87	Deadlocking round corner		
799F875	PZD - Schlage LFIC cylinder CL3352 inside	586F82	Throw-Off square corner		
799F645	PZD - Sargent® cylinder	586F88	Throw-Off round corner		
799F655	PZD - Sargent® cylinder CL3352 inside	<b>5" Backsets</b>			
712F305	FZD - LH plain	598F20	Plain, square corner	\$96.00	
712F315	FZD - LH cylinder or botton	601F24	Plain, round corner		
712F445	FZD - LH CL3352 inside	598F21	Deadlocking square corner	\$104.00	
712F325	FZD - LH emergency key hole	601F25	Deadlocking round corner		
712F345	FZD - LH LFIC cylinder - 6 pin	598F22	Throw-Off square corner		
712F465	FZD - LH LFIC cylinder - 6 pin CL3352 inside	601F26	Throw-Off round corner		
712F355	FZD - LH LFIC cylinder - 7 pin				
712F475	FZD - LH LFIC cylinder - 7 pin CL3352 inside				
712F365	FZD - LH SFIC (Best®) cylinder				
712F485	FZD - LH SFIC (Best®) cylinder CL3352 inside				
712F375	FZD - LH Schlage® LFIC cylinder				
712F495	FZD - LH Schlage® LFIC cylinder CL3352 inside				

# CL3300 Cylindrical Lock Series Extra Heavy-Duty Lever Lockset

## LOCKSET PARTS

PART NO.	DESCRIPTION	LIST PRICE
<b>LATCH &amp; STRIKE SCREW PACKS</b>		
604F228 Fin	Latch & ANSI (4 7/8") strike - phillips head	\$4.60
604F238 Fin	Latch & ANSI (4 7/8") strike - spanner head	\$13.10
604F248 Fin	Latch & ANSI (4 7/8") strike - Torx head	\$13.10
604F268 Fin	Latch & T (2 3/4") strike - phillips head	\$4.50
604F278 Fin	Latch & T (2 3/4") strike - spanner head	\$13.10
604F288 Fin	Latch & T (2 3/4") strike - Torx head	\$13.10
480F688 Fin	Rabbetted Strike - phillips head	\$4.60
596F618 Fin	Rabbetted Strike - spanner head	\$13.10
596F628 Fin	Rabbetted Strike - Torx head	\$13.10
<b>MOUNTING SCREW PACKS</b>		
682F608	1 3/4" - 2" doors (pre June 2004)	\$5.00
710F658	1 3/4" - 2" doors (after June 2004)	
682F618	Over 2" (pre June 2004)	\$9.10
710F668	Over 2" (after June 2004)	
682F628	CL3380, CL3381 1 3/4" - 2" doors	\$5.00
682F638	CL3380, CL3381 over 2" doors	\$9.10
682F64 Fin	CL3390, CL3391 1 3/4" - 2" phillips head	\$7.00
682F67 Fin	CL3390, CL3391 1 3/4" - 2" spanner head	\$13.10
682F68 Fin	CL3390, CL3391 1 3/4" - 2" Torx head	\$13.10
682F65 Fin	CL3390, CL3391 over 2" phillips head	\$41.00
682F86 Fin	CL3390, CL3391 over 2" spanner head	\$44.00
682F87 Fin	CL3390, CL3391 over 2" Torx head	\$46.00
684F44 Fin	CL3350 Half Dummy Trim - phillips head	\$9.10
684F45 Fin	CL3350 Half Dummy Trim - spanner head	\$44.00
684F46 Fin	CL3350 Half Dummy Trim - Torx head	\$46.00
684F528	CL3370 Half Dummy Trim	\$5.00
<b>BUTTONS</b>		
585F76 Fin	Turnbutton CL3351	\$19.50
585F77 Fin	Pushbutton CL3320, CL3320H, CL3320TO, CL3340, CL3361, CL3375	\$17.50
585F78 Fin	Hotel button CL3329	
585F79 Fin	Slotted button CL3393	

PART NO.	DESCRIPTION	LIST PRICE
<b>STRIKE BOX</b>		
120F768	4-7/8" ANSI strike box	\$9.00
<b>FRONT PLATE RABBETTED STRIKE</b>		
315F93 Fin*	606, 612, 619, 626, 605, 611, 613, 625	\$55.30
<b>RABBETTED STRIKE</b>		
315F94 Fin*	606, 612, 619, 626, 605, 611, 613, 625	\$55.30
601F283 Fin*	Rabbetted Strike & Front	\$86.30
<b>ROSES</b>		
678F25 Fin	Rose	\$26.00
598F59 Fin	Blank Rose	\$28.00
710F618	Rose liner I/S 1 3/4" - 2" after June 2004	\$4.30
710F628	Rose liner I/S over 2" after June 2004	\$5.00
678F248	Rose liner O/S 1 3/4" - 2"	
678F498	Rose liner O/S over 2"	\$5.70
586F51 Fin	Thumbturn ass'y 1 3/4" - 2"	\$85.80
686F88 Fin	Thumbturn ass'y over 2"	
682F788	Rose liner CL3380, CL3381	\$23.90
<b>STRIKES - 4 7/8" ANSI CURVED LIP</b>		
217L13M016	1" Lip Length	\$19.30
217L13M018	1 1/8" Lip Length	
217L13M020	1 1/4" Lip Length	
217L13M022	1 3/8" Lip Length	
217L13M024	1 1/2" Lip Length	
217L13M028	1 3/4" Lip Length	\$20.30
217L13M032	2" Lip Length	
217L13M036	2 1/4" Lip Length	
217L13M040	2 1/2" Lip Length	
217L13M044	2 3/4" Lip Length	
217L13M048	3" Lip Length	
<b>STRIKES - 2 3/4" T- CURVED LIP</b>		
586L19M016	1" Lip Length	\$20.30
586L19M018	1 1/8" Lip Length	
586L19M020	1 1/4" Lip Length	
586L19M022	1 3/8" Lip Length	
586L19M024	1 1/2" Lip Length	
586L19M028	1 3/4" Lip Length	\$22.30
586L19M032	2" Lip Length	
586L19M036	2 1/4" Lip Length	
586L19M040	2 1/2" Lip Length	
586L19M044	2 3/4" Lip Length	
586L19M048	3" Lip Length	
<b>EMERGENCY RELEASE TOOL</b>		
679F818	Emergency Release Tool (CL3320)	\$1.20
601F829	Emergency Release Label (CL3320)	

## ASSA ABLOY

PART NO.	DESCRIPTION	LIST PRICE
<b>BUTTONS</b>		<b>ALL FINISH</b>
585F762	CL3551 (Turn Button)	\$19.50
585F772	CL3520, 61 (Push Button)	\$17.50
<b>CASSETTE HOUSING O/S</b>		<b>NO FINISH</b>
796F378	Standard	\$28.80
686F858	CL3550, 70	\$108.00
<b>CASSETTE HOUSING I/S</b>		<b>NO FINISH</b>
796F408	CL3580, 81	\$20.70
686F868	CL3570	\$94.40
796F398	Standard I/S Spring Housing	\$11.00
<b>CHASSIS ASSEMBLY, STANDARD</b>		<b>NO FINISH</b>
796F208	CL3510	\$80.30
796F218	CL3520, 61	\$108.60
796F248	CL3580	\$110.60
796F228	CL3551, 57	\$110.60
796F238	CL3555	\$114.60
796F258	CL3581	\$129.60
796F268	CL3582	\$153.60
<b>CHASSIS ASSEMBLY, LFIC</b>		<b>NO FINISH</b>
796F318	CL3561	\$114.60
796F328	CL3551, 57	\$116.60
796F338	CL3555	\$120.60
796F358	CL3581	\$135.60
796F368	CL3582	\$159.60
<b>CYLINDER PARTS</b>		<b>NO FINISH</b>
622F308	Tailpiece 6-Pin	\$2.00
682F298	Tailpiece 7-pin	\$1.90
682F398	M06 - Schlage® tailpiece kit	\$6.30
682F969	M09 - Sargent® tailpiece kit	\$17.40
631F248	C6/C7 - LFIC tailpiece kit	\$5.60
682F958	M08 - small format IC kit	\$5.60
697F292	M69 - Schlage® IC tailpiece kit	\$23.00
<b>HOUSING ASSEMBLIES</b>		
796F388	Housing Assembly, I/S, D134	\$20.70
796F398	Housing Assembly, I/S, D138	\$15.50

## CL3500 Cylindrical Lock Series Heavy-Duty Lever Lockset

PART NO.	DESCRIPTION	LIST PRICE	
<b>LATCHES</b>		<b>ALL FINISH</b>	
<b>Deadlocking Latches</b>			
599F92	2-3/8" backset x 1" front	\$61.90	
599F95	2-3/8" backset x 1" round corner		
599F98	2-3/8" backset x 1-1/8" front		
600F01	2-3/8" backset x 1-1/8" round corner		
600F04	2-3/4" backset x 1" front		
600F07	2-3/4" backset x 1" round corner		
600F10	2-3/4" backset x 1-1/8" front		
600F13	2-3/4" backset x 1-1/8" round corner		
600F63	3-3/4" backset x 1-1/8" front		\$85.90
600F66	3-3/4" backset x 1-1/8" round corner		
600F69	5" backset x 1-1/8" front	\$87.90	
600F72	5" backset x 1-1/8" round corner		
<b>Deadlocking Latches with Release (CL3520)</b>			
599F93	2-3/8" backset x 1" front	\$61.90	
599F96	2-3/8" backset x 1" round corner		
599F99	2-3/8" backset x 1-1/8" front		
600F02	2-3/8" backset x 1-1/8" round corner		
600F05	2-3/4" backset x 1" front		
600F08	2-3/4" backset x 1" round corner		
600F11	2-3/4" backset x 1-1/8" front		
600F14	2-3/4" backset x 1-1/8" round corner		
600F64	3 3/4" backset x 1 1/8" front		\$85.90
600F67	3-3/4" backset x 1-1/8" round corner		
600F70	5" backset x 1 1/8" front	\$87.90	
600F73	5" backset x 1-1/8" round corner		
<b>Plain Spring Latches (CL3610)</b>			
599F91	2-3/8" backset x 1" front	\$55.90	
599F94	2-3/8" backset x 1" round corner		
599F97	2-3/8" backset x 1-1/8" front		
600F00	2-3/8" backset x 1-1/8" round corner		
600F03	2-3/4" backset x 1" front		
600F06	2-3/4" backset x 1" round corner		
600F09	2-3/4" backset x 1-1/8" front		
600F12	2-3/4" backset x 1-1/8" round corner		
600F62	3-3/4" backset x 1-1/8" front		\$75.90
600F65	3-3/4" backset x 1-1/8" round corner		
600F68	5" backset x 1-1/8" front	\$77.90	
600F71	5" backset x 1-1/8" round corner		

## CL3500 Cylindrical Lock Series Heavy-Duty Lever Lockset

PART NO.	DESCRIPTION	LIST PRICE
<b>LEVERS</b>		<b>ALL FINISH</b>
598F815	AZD x plain	\$82.50
598F825	AZD x cylinder or button	\$82.50
598F835	AZD x emergency hole	\$82.50
598F905	AZD x C6 LFIC 6-pin	\$84.50
599F275	AZD x C7 LFIC 7-pin	\$84.50
797F845	NZD x plain	\$82.50
797F855	NZD x cylinder or button	\$82.50
797F865	NZD x emergency hole	\$82.50
797F875	NZD x M09 Sargent® cylinder	\$84.50
797F915	NZD x C6 LFIC 6-pin	\$84.50
797F925	NZD x C7 LFIC 7-pin	\$84.50
797F935	NZD x M69 Schlage LFIC	\$86.50
797F945	NZD x M08 SFIC	\$86.50
798F115	PZD x plain	\$82.50
798F125	PZD x cylinder or button	
798F135	PZD x emergency hole	
798F145	PZD x M09 Sargent® cylinder	\$84.50
798F155	PZD x C6 LFIC 6-pin	
798F165	PZD x C7 LFIC 7-pin	
798F175	PZD x M69 Schlage® LFIC	\$86.50
798F185	PZD x M08 SFIC	
<b>LEVER INSERT</b>		<b>ALL FINISH</b>
598F809	Standard	\$0.30
<b>MOUNTING SCREW PACK</b>		
796F118	Standard	\$3.80
797F828	Standard - CL3580, 81	\$11.90
684F448	CL3550 (ALL FINISH)	\$9.10
684F528	CL3570	\$5.00

PART NO.	DESCRIPTION	LIST PRICE
<b>ROSES</b>		<b>ALL FINISH</b>
678F252	Standard	\$26.00
598F592	Blank - CL3580, 81	\$28.00
<b>ROSE LINER O/S</b>		<b>NO FINISH</b>
678F248	Standard	\$5.00
682F788	CL3580, 81	\$23.90
<b>SCREW PACKS FOR LATCH &amp; STRIKE</b>		
604F228	For Latch & ANSI Strike	\$4.60
604F268	For Latch & (T strike)	\$4.50
<b>STRIKES</b>		<b>NO FINISH</b>
<b>ANSI Curved Lip Strike</b>		
217L13M016	1" Lip Length	\$19.30
217L13M018	1-1/8" Lip Length	
217L13M020	1-1/4" Lip Length	
217L13M022	1-3/8" Lip Length	
217L13M024	1-1/2" Lip Length	
217L13M028	1-3/4" Lip Length	\$20.30
217L13M032	2" Lip Length	
217L13M036	2-1/4" Lip Length	
217L13M040	2-1/2" Lip Length	
217L13M044	2-3/4" Lip Length	
217L13M048	3" Lip Length	
<b>STRIKE BOX</b>		<b>NO FINISH</b>
120F768	M17 - ANSI wrought	\$9.00
025F858	Curved lip (T strike)	\$2.80

## CL3700 Cylindrical Lock Series Grade 2 Key-In-Lever Locksets

<b>CL3700 SERIES</b>			<b>CL3700 SERIES</b>		
PART NO.	DESCRIPTION	LIST PRICE	PART NO.	DESCRIPTION	LIST PRICE
<b>UL LATCH ASSEMBLY</b>		<b>605, 612, 613, 626</b>	<b>STRIKES</b>		
<b>2-3/4" BACKSET</b>			687F60	Curved lip "T"	\$6.50
687F63	2-1/4" x 1-1/8" square corner front	\$20.70	687F61	Full lip square corner	\$6.90
<b>2-3/8" BACKSET</b>			687F62	Full lip radius corner	
687F64	2-1/4" x 1" square corner front	\$20.70	687F94	Dust box for 687F60 strike	\$4.40
687F65	2-1/4" x 1" x 1/4" rounded corner front				
Note: All CL3700 latches are deadlocking			687F95	Dust box for 687F61, 687F62 strikes	
<b>LATCH SLEEVE</b>			217L13	ANSI curved lip	\$20.00
687F71	1" Latch sleeve	\$0.70	120F76-8	Dust box for 679L25 strike	\$4.00
			<b>MISCELLANEOUS</b>		
			687F96	Screw pack	\$5.50
			687F66	UL Fire cup	\$8.20
			679F818	Emergency Release Tool	\$2.30



## CL3800 PARTS

PART NO.	DESCRIPTION	LIST PRICE
<b>BUTTONS</b>		<b>ALL FINISH</b>
585F762	CL3851 (Turn Button)	\$19.50
585F772	CL3820, 40, 61 (Push Button)	\$17.50
585F792	CL3893 (Slotted Turn Button)	\$17.50
<b>CASSETTE HOUSING O/S</b>		<b>NO FINISH</b>
796F378	Standard	\$28.80
686F858	CL3850, 70	\$108.00
<b>CASSETTE HOUSING I/S</b>		<b>NO FINISH</b>
796F398	Standard - 1-3/8" to 1-7/8" door	\$15.50
797F808	D214 - 2" to 2-1/4" door	\$20.70
796F408	CL3880, 81	\$20.70
686F868	CL3870	\$94.40
<b>CHASSIS ASSEMBLY, STANDARD</b>		<b>NO FINISH</b>
797F618	CL3810	\$48.90
797F628	CL3820, 61	\$54.90
797F648	CL3840	\$54.90
797F788	CL3840NT	\$54.90
797F658	CL3880, 90	\$48.90
797F668	CL3851, 57, 93	\$58.90
797F688	CL3855	\$58.90
797F708	CL3881, 91	\$58.90
797F728	CL3832	\$62.90
797F748	CL3862	\$62.90
797F768	CL3872	\$62.90
<b>CHASSIS ASSEMBLY, IC</b>		<b>NO FINISH</b>
797F638	CL3861	\$56.90
797F678	CL3851, 57, 93	\$60.90
797F698	CL3855	\$60.90
797F718	CL3881, 91	\$60.90
797F738	CL3832	\$64.90
797F758	CL3862	\$64.90
797F778	CL3872	\$64.90

PART NO.	DESCRIPTION	LIST PRICE
<b>CYLINDER PARTS</b>		<b>NO FINISH</b>
622F308	Tailpiece 6-Pin	\$2.00
682F298	Tailpiece 7-pin	\$1.90
682F398	M06 - Schlage® tailpiece kit	\$17.40
682F969	M09 - SARGENT® tailpiece kit	\$17.40
631F248	C6/C7 - LFIC tailpiece kit	\$5.60
682F958	M08 - SFIC kit	\$5.60
697F942	M69 - Schlage® LFIC tailpiece kit	\$23.00
<b>LATCHES</b>		<b>ALL FINISH</b>
<b>Deadlocking Latches</b>		
599F92	2-3/8" backset x 1" front	\$61.90
599F95	2-3/8" backset x 1" round corner	
599F98	2-3/8" backset x 1-1/8" front	
600F01	2-3/8" backset x 1-1/8" round corner	
600F04	2-3/4" backset x 1" front	
600F07	2-3/4" backset x 1" round corner	
600F10	2-3/4" backset x 1-1/8" front	
600F13	2-3/4" backset x 1-1/8" round corner	\$85.90
600F63	3-3/4" backset x 1-1/8" front	
600F66	3-3/4" backset x 1-1/8" round corner	\$85.90
600F69	5" backset x 1-1/8" front	\$87.90
600F72	5" backset x 1-1/8" round corner	\$87.90
<b>Deadlocking Latches with Release (CL3820, 40, 93)</b>		
599F93	2-3/8" backset x 1" front	\$61.90
599F96	2-3/8" backset x 1" round corner	
599F99	2-3/8" backset x 1-1/8" front	
600F02	2-3/8" backset x 1-1/8" round corner	
600F05	2-3/4" backset x 1" front	
600F08	2-3/4" backset x 1" round corner	
600F11	2-3/4" backset x 1-1/8" front	
600F14	2-3/4" backset x 1-1/8" round corner	\$85.90
600F64	3 3/4" backset x 1 1/8" front	
600F67	3-3/4" backset x 1-1/8" round corner	\$85.90
600F70	5" backset x 1 1/8" front	\$87.90
600F73	5" backset x 1-1/8" round corner	\$87.90
<b>Plain Spring Latches (CL3610)</b>		
599F91	2-3/8" backset x 1" front	\$55.90
599F94	2-3/8" backset x 1" round corner	
599F97	2-3/8" backset x 1-1/8" front	
600F00	2-3/8" backset x 1-1/8" round corner	
600F03	2-3/4" backset x 1" front	
600F06	2-3/4" backset x 1" round corner	
600F09	2-3/4" backset x 1-1/8" front	
600F12	2-3/4" backset x 1-1/8" round corner	\$75.90
600F62	3-3/4" backset x 1-1/8" front	
600F65	3-3/4" backset x 1-1/8" round corner	\$75.90
600F68	5" backset x 1-1/8" front	\$77.90
600F71	5" backset x 1-1/8" round corner	\$77.90

# CL3800 Cylindrical Lock Series Grade 2 Key-In-Lever Lockset

## CL3800 PARTS

PART NO.	DESCRIPTION	LIST PRICE
<b>LEVERS 1-3/8" to 1-7/8" Doors</b>		<b>ALL FINISH</b>
598F815	AZD x plain	\$82.50
598F825	AZD x cylinder or button	\$82.50
598F835	AZD x emergency hole	\$82.50
598F905	AZD x C6 LFIC 6-pin	\$84.50
599F275	AZD x C7 LFIC 7-pin	\$84.50
797F845	NZD x plain	\$82.50
797F855	NZD x cylinder or button	\$82.50
797F865	NZD x emergency hole	\$82.50
797F875	NZD x M09 Sargent® cylinder	\$84.50
797F915	NZD x C6 LFIC 6-pin	\$84.50
797F925	NZD x C7 LFIC 7-pin	\$84.50
797F935	NZD x M69 Schlage LFIC	\$86.50
797F945	NZD x M08 SFIC	\$86.50
798F115	PZD x plain	\$82.50
798F125	PZD x cylinder or button	\$82.50
798F135	PZD x emergency hole	\$82.50
798F145	PZD x M09 Sargent® cylinder	\$84.50
798F155	PZD x C6 LFIC 6-pin	\$84.50
798F165	PZD x C7 LFIC 7-pin	\$84.50
798F175	PZD x M69 Schlage® LFIC	\$86.50
798F185	PZD x M08 SFIC	\$86.50
<b>LEVERS 2" to 2-1/4" Doors - D214</b>		<b>ALL FINISH</b>
684F775	AZD x plain	\$99.00
684F785	AZD x cylinder or button	\$99.00
684F795	AZD x emergency hole	\$99.00
684F805	AZD x C6 LFIC 6-pin	\$101.00
684F815	AZD x C7 LFIC 7-pin	\$101.00
684F825	NZD x plain	\$99.00
684F835	NZD x cylinder or button	\$99.00
684F845	NZD x emergency hole	\$99.00
684F855	NZD x M09 Sargent® cylinder	\$101.00
684F865	NZD x C6 LFIC 6-pin	\$101.00
684F875	NZD x C7 LFIC 7-pin	\$101.00
690F985	NZD x M69 Schlage® LFIC	\$103.00
684F885	NZD x M08 SFIC	\$103.00
798F215	PZD x plain	\$99.00
798F225	PZD x cylinder or button	\$99.00
798F235	PZD x emergency hole	\$99.00
798F245	PZD x M09 Sargent® cylinder	\$101.00
798F255	PZD x C6 LFIC 6-pin	\$101.00
798F265	PZD x C7 LFIC 7-pin	\$101.00
798F275	PZD x M69 Schlage® LFIC	\$103.00
798F285	PZD x M08 SFIC	\$103.00

PART NO.	DESCRIPTION	LIST PRICE
<b>LEVER INSERT</b>		<b>ALL FINISH</b>
598F809	Standard - 1-3/8" to 1-7/8" door	\$0.30
684F539	D214 - 2" to 2-1/4" door	\$40.20
<b>MOUNTING SCREW PACK</b>		
796F118	Standard - 1-3/8" to 1-7/8" door	\$3.80
797F818	D214 - 2" to 2-1/4" door	\$15.20
797F828	Standard - CL3880, 81, 90, 91	\$11.90
797F838	D214 - CL3880, 81, 90, 91	\$15.20
684F448	CL3850 (ALL FINISH)	\$9.10
684F528	CL3870	\$5.00
<b>ROSES</b>		<b>ALL FINISH</b>
678F252	Standard	\$26.00
598F592	Blank - CL3880, 81	\$28.00
<b>ROSE LINER O/S</b>		<b>NO FINISH</b>
678F248	Standard - 1-3/8" to 1-7/8" door	\$5.00
678F498	D214 - 2" to 2-1/4" door	\$5.70
682F788	CL3880, 81	\$23.90
<b>SCREW PACK FOR LATCH &amp; STRIKE</b>		<b>ALL FINISH</b>
604F228	For Latch & ANSI Strike	\$4.60
604F268	For Latch & 'T' or Full Lip Strike	\$4.50
<b>STRIKES*</b>		<b>ALL FINISH</b>
217L13	ANSI Curved Lip Strike	\$20.00
680L52	ANSI Curved Lip Blank Strike	
586L19	T-Strike	\$22.00
680L50	Full Lip Strike	\$14.30
680L51	Full Lip Strike 1/4" Radius (Available Only 1-1/4" Lip)	
<b>STRIKE BOX</b>		<b>NO FINISH</b>
120F768	M17 - ANSI wrought	\$9.00
025F858	Curved lip (T strike)	\$2.80
<b>THUMBTURNS</b>		<b>ALL FINISH</b>
586F512	Standard - CL3890, 91	\$85.80
686F882	D214 - CL3890, 91	\$85.80

\*Specify length and finish

## CK4200 Series Heavy-Duty Cylindrical Locksets

LATCHES		
PART NO.	DESCRIPTION	LIST PRICE
(2-1/4" X 1-1/8" SQUARE CORNER FRONT) 605, 613E, 630		
<b>- 2-3/4" Backset</b>		
486F83*	Plain, beveled	\$56.50
486F89*	Deadlocking, beveled	\$66.50

\*For M26 non-ferrous option, change "-8" to "-7". Contact factory for prices

## CK4300 Series Heavy-Duty Cylindrical Locksets

LOCKSET PARTS					
PART NO.	DESCRIPTION	LIST PRICE	PART NO.	DESCRIPTION	LIST PRICE
<b>SCREW PACKET</b> 605, 613E, 630			<b>STRIKE (Cont'd)</b>		
556F55-8	for CK4350 †Order 50-	\$1.40	<b>Curved Lip Box Strike</b>		
604F26-8	for curved lip strike	\$4.50	586L19M016	1" Lip Length	\$20.30
604F29-8	for curved lip strike x hex head (M04)	\$10.90	586L19M018	1-1/8" Lip Length	
604F27-8	for curved lip strike x spanner head (M02)	\$14.40	586L19M020	1-1/4" Lip Length	
604F28-8	for curved lip strike x Torx® head (M04)	\$13.10	586L19M022	1-3/8" Lip Length	
604F25-8	for hex head (M04)	\$4.20	586L19M024	1-1/2" Lip Length	
604F23-8	for spanner head (M02)	\$13.10	586L19M028	1-3/4" Lip Length	
480F68	for SR118	\$4.60	586L19M032	2" Lip Length	\$22.30
596F63-8	for SR118 & hex head (M04)	\$6.30	586L19M036	2-1/4" Lip Length	
596F61-8	for SR118 & spanner head (M02)	\$7.30	586L19M040	2-1/2" Lip Length	
596F62-8	for SR118 & Torx head (M04)		586L19M044	2-3/4" Lip Length	
604F22-8	standard	\$4.60	586L19M048	3" Lip Length	
604F24-8	for Torx head (M04)	\$13.10	<b>ANSI Wrought Strike Box</b> <b>No Finish</b>		
224F00-8*	Screw, Sems Assembly #8 -32 X 1-1/4" †Order 100-	\$0.40	120F76-8	ANSI Wrought Strike Box (M17)	\$4.00
<b>STRIKE</b> 605, 613E, 630					
<b>ANSI Curved Lip Strike</b>					
217L13M016	1" Lip Length	\$19.30			
217L13M018	1-1/8" Lip Length				
217L13M020	1-1/4" Lip Length				
217L13M022	1-3/8" Lip Length				
217L13M024	1-1/2" Lip Length				
217L13M028	1-3/4" Lip Length	\$20.30			
217L13M032	2" Lip Length				
217L13M036	2-1/4" Lip Length				
217L13M040	2-1/2" Lip Length				
217L13M044	2-3/4" Lip Length				
217L13M048	3" Lip Length				

†Sold only in multiples of the number indicated. Price is each.

# CK4400/CK4700 Series Standard Cylindrical Locksets

CK4400 SERIES		
PART NO.	DESCRIPTION	LIST PRICE
<b>STRIKES AND WROUGHT BOX</b>		
ANSI TYPE 605, 606, 611, 612, 613, 619, 625, 626		
217L13M016	1" Lip to Center	\$19.30
217L13M018	1-1/8" Lip to Center	
217L13M020	1-1/4" Lip to Center (standard)	
217L13M022	1-3/8" Lip to Center	
217L13M024	1-1/2" Lip to Center	
217L13M028	1-3/4" Lip to Center	\$20.30
217L13M032	2" Lip to Center	
217L13M036	2-1/4" Lip to Center	
217L13M040	2-1/2" Lip to center	
217L13M044	2-3/4" Lip to Center	
217L13M048	3" Lip to Center	
<b>ANSI WROUGHT STRIKE BOX NO FINISH</b>		
120F76-8	Box only	\$4.00
<b>CURVED LIP BOX TYPE STRIKE 605, 606, 611, 612, 613, 619, 625, 626</b>		
586L19M016	1" Lip Length	\$20.30
586L19M018	1-1/8" Lip Length	
586L19M020	1-1/4" Lip Length	
586L19M022	1-3/8" Lip Length	
586L19M024	1-1/2" Lip Length	
586L19M028	1-3/4" Lip Length	\$22.30
586L19M032	2" Lip Length	
586L19M036	2-1/4" Lip Length	
586L19M040	2-1/2" Lip Length	
586L19M044	2-3/4" Lip Length	
586L19M048	3" Lip Length	
<b>ROSE NO FINISH</b>		
579F11	Screw Packet & Strike Box	\$5.20
580F38-7	Rose Sub Assembly, stainless I/S	\$15.20
580F38	Rose Sub Assembly I/S	\$13.70
<b>LATCHES</b>		
574F29	2-3/8" deadlatch	\$35.80
574F30	2-3/8" deadlatch with throw-off	
574F55	2-3/4" deadlatch	
574F56	2-3/4" deadlatch with throw-off	
574F29 x574F25	3-3/4" deadlatch	\$64.00
574F30 x574F25	3-3/4" deadlatch with throw-off	
574F29 x574F26	5" deadlatch	
574F30 x574F26	5" deadlatch with throw-off	
<b>BACKSET EXTENDER KIT</b>		
574F25-8	Extender ONLY (No Latch Unit) - Must be added to 2-3/8" Latch Unit	\$28.20
574F26-8	Extender ONLY (No Latch Unit) - Must be added to 2-3/8" Latch Unit	

CK4700 SERIES		
PART NO.	DESCRIPTION	LIST PRICE
<b>UL LATCH ASSEMBLY 605, 612, 613, 626</b>		
<b>2-3/4" Backset</b>		
687F63	2-1/4" x 1-1/8" square corner front	\$20.70
<b>2-3/8" Backset</b>		
687F64	2-1/4" x 1" square corner front	\$20.70
687F65	2-1/4" x 1" x 1/4" rounded corner front	
Note: All CK4700 latches are deadlocking		
<b>LATCH SLEEVE</b>		
687F71	1" Latch sleeve	\$0.70
<b>STRIKES</b>		
687F60	Curved lip 'T'	\$6.50
687F61	Full lip square corner	\$6.90
687F62	Full lip radius corner	
687F94	Dust box for 687F60 strike	\$4.40
687F95	Dust box for 687F61, 687F62 strikes	
217L13	ANSI curved lip	\$20.00
120F76-8	Dust box for 679L25 strike	\$4.00
<b>MISCELLANEOUS</b>		
687F96	Screw pack	\$5.50
687F66	UL Fire cup	\$8.20

**LOCKSET PARTS**

PART NO.	DESCRIPTION	LIST PRICE	PART NO.	DESCRIPTION	LIST PRICE
<b>BUSHING NO FINISH</b>			<b>HUB SPACER NO FINISH</b>		
194F22-8	Bushing	\$3.30	060F33-8	for UT5210, 61 †Order 50-	\$1.80
<b>BUTTON ASSEMBLY 612, 613, 619, 625, 626</b>			070F42-8	for UT5220 †Order 50-	\$1.80
022F80	for UT5220	\$51.00	070F43-8	for UT5220 †Order 50-	\$3.70
157F11	for UT5251		606F03-8	for UT5255	\$1.10
156F43	for UT5261		067F42-8	for UT5257	\$3.00
<b>CHASSIS COVER NO FINISH</b>			<b>LEVER 612, 613, 619, 625, 626</b>		
138F88-8	Chassis Cover	\$6.10	582F12-2	cyl/button LH	\$180.60
<b>CHASSIS 612, 613, 619, 625, 626</b>			582F11-2	cyl/button RH	
496F33	for UT5210	\$296.40	582F14-2	cyl/button LH tactile	\$188.60
496F34	for UT5220		582F13-2	cyl/button RH tactile	
496F32	for UT5251, 55, 57, 72		489F89-2	LFIC 6-pin LH	\$186.60
198F71	for UT5261		489F88-2	LFIC 6-pin RH	
381F30	for UT5282		549F36-2	LFIC 6-pin LH tactile	\$192.60
<b>CORE HOUSING NO FINISH</b>			549F35-2	LFIC 6-pin RH tactile	
342F05-2	for 6-pin LFIC	\$10.90	613F23-2	LFIC 7-pin LH	\$186.60
442F95-2	for 7-pin LFIC		613F22-2	LFIC 7-pin RH	
613F35-2	for 6/7 pin Best-type LFIC	\$8.60	613F25-2	LFIC 7-pin LH tactile	\$194.60
<b>COUPLING NO FINISH</b>			613F24-2	LFIC 7-pin RH tactile	
131F27-8	Coupling	\$50.00	613F11-2	plain LH	\$180.60
<b>EMERGENCY KEY NO FINISH</b>			613F10-2	plain RH	
398F43-8	for UT5220	\$1.90	613F15-2	plain LH tactile	\$188.60
<b>ESCUTCHEON 612, 613, 619, 625, 626</b>			613F14-2	plain RH tactile	
144F33	for inside lever	\$146.00	613F13-2	priv. key hole LH	\$180.60
415F16	for outside knob		613F12-2	priv. key hole RH	
144F34	for outside lever		613F17-2	priv. key hole LH tactile	\$188.60
605F90	for inside lever, lead lined		613F16-2	priv. key hole RH tactile	
301F56-7	for outside lever, ext. lip 630 only		613F43-2	Best - type core prep LH	\$206.60
<b>GRIP RETAINER NO FINISH</b>			613F42-2	Best - type core prep RH	
078F07-8	Grip Retainer †Order 50-	\$0.50	<b>LEVER INSERT NO FINISH</b>		
<b>GRIP RETAINER RING NO FINISH</b>			613F02-9	Lever Insert †Order 50-	\$0.80
078F08-8	Grip Retainer Ring †Order 100-	\$0.30	<b>LEVER SPRING ANCHOR NO FINISH</b>		
<b>HUB NO FINISH</b>			171F79-8	Lever Spring Anchor	\$15.20
060F42-8	for all but UT5255	\$3.00	<b>PIN NO FINISH</b>		
071F62-8	for UT5210	\$4.30	019F13-7	Pin, Spindle Drive †Order 50-	\$1.30
081F77-8	for UT5220	\$4.60	156F83-7	Pin, UT5261 shank †Order 50-	\$0.60
147F07-8	for UT5251, 55, 72	\$2.70	286F50-7	Pin, UT5282 spindle †Order 50-	\$0.78
140F97-8	for UT5251, 57, 72	\$2.50			
071F63-8	for UT5257	\$2.60			

†Sold only in multiples of the number indicated. Price is each.

# UT5200 Series Pre-Assembled Unit Locksets

PART NO.	DESCRIPTION	LIST PRICE
<b>PLUG DRIVER NO FINISH</b>		
144F88-8	Plug Driver & Spindle Assembly UT5282	\$36.90
168F81-8	Plug Driver Assembly	\$24.10
144F29-8	Plug Driver UT5251, 57, 72	\$14.10
606F01-8	Plug Driver UT5255	\$13.10
145F32-8	Plug Driver UT5282	\$36.90
<b>RETAINING RING NO FINISH</b>		
251F19-8	Retaining Ring for UT5282 Spindle †Order 100-	\$0.20
<b>SCREW 612, 619, 626, 613, 625</b>		
480F70	Screw Pkt. (strike mount'g) †Order 20-	\$2.10
<b>No Finish</b>		
249F76-8	Screw, Fixed Escutcheon †Order 50-	\$0.50
092F78-9	Screw, Strike Adjustment (nylon) †Order 50-	\$0.78
<b>SHANK, LEVER NO FINISH</b>		
102F19-8	for UT5210, 57 outside	\$44.50
102F37-8	for UT5220 inside	
114F67-8	for UT5220 outside	
188F75-8	for UT5251, 57, 72 outside	
188F73-8	for UT5251, 72 inside	\$50.50
605F76-8	for UT5255 inside	\$46.50
605F77-8	for UT5255 outside	\$46.50
156F65-8	for UT5261 inside	\$80.50
156F64-8	for UT5261 outside	\$54.50
102F27-8	for UT5282 inside	\$46.50
287F60-8	for UT5282 outside	\$68.50
<b>SHANK RETAINER NO FINISH</b>		
219F80-8	for knob †Order 20-	\$1.30
242F50-8	for lever †Order 50-	\$0.90

† Sold only in multiples of the number indicated. Price is each.

PART NO.	DESCRIPTION	LIST PRICE
<b>SPINDLE NO FINISH</b>		
201F18-8	for UT5220	\$7.40
144F30-8	for UT5251, 72	\$6.90
606F02-8	for UT5255	\$7.00
335F98-8	for UT5257	\$10.40
<b>SPRING NO FINISH</b>		
022F72-3	Spring, Button UT5220, 61 †Order 50-	\$0.30
103F45-8	Spring, Lever Return LH	\$8.60
103F44-8	Spring, Lever Return RH	\$8.60
060F05-3	Spring, Shoe UT5220, 61 †Order 100-	\$0.32
071F67-3	Spring, Spindle for UT5220 †Order 100-	\$0.26
249F77-3	Spring, Spindle for UT5251, 55, 57, 72 †Order 100-	\$0.26
261F11-8	Spring, Spindle for UT5282 †Order 100-	\$0.18
<b>SPRING SEAT NO FINISH</b>		
019F11-7	Spring Seat	1.60
<b>STRIKE 612, 613, 625, 626</b>		
236L75M020	ANSI curved lip	\$21.30
610L44	ANSI straight lip	
610L43	ANSI straight lip for ext. esc.	
083L96M032	curved lip box, 2"	
083L96M036	curved lip box, 2-1/4"	
083L96M034	curved lip box, 2-1/8" (std)	
083L96M040	curved lip box, 2-1/2"	
083L96M048	curved lip box, 3"	
293L14	curved lip box for ext. lip esc.	
082L67	pairs of doors	
<b>THROUGHBOLT</b>		
222F85	Regular	\$5.00
223F29	Spanner head	\$4.60
<b>THROW MEMBER NO FINISH</b>		
320F44-2	for Best® style core	\$5.70
342F03-2	for Corbin Russwin core	\$5.50

## Padlocks and Deadlocks

### PADLOCKS

PART NO.	DESCRIPTION	LIST PRICE	SOLD IN MULT. OF
422L84-2144	Chain & clevis, 9" brass	\$19.50	1
422L84-8144	Chain & clevis, 9" steel	\$17.50	1
303F24-2	Pin chamber cap	\$0.60	100
242F48-2	Plug and shackle retainer screw	\$0.70	100
228F34-8	Plug retainer, oversize Spirol pin	\$0.50	100
244F64-7	Plug retainer, standard solid pin	\$1.38	20
405F77-2	Security disc	\$0.80	50
756F963	Throw member, LFIC models	\$8.00	10

### DL4100 SERIES DEADLOCK PARTS

PART NO.	DESCRIPTION	LIST PRICE	SOLD IN MULT. OF
796F46 x Fin	Outside Front	\$81.40	
796F30 x Fin	Thumbturn Assembly	\$68.00	
791F51 x Fin	Ergonomic Thumbturn Assembly	\$62.00	
<b>Mouting Packs:</b>			
791F82 Fin	Screw Pack - Standard Strike	\$20.00	
791F83 Fin	Spanner Head crew Pack - Standard Strike	\$12.40	
791F84 Fin	Torx Head Screw Pack - Standard Strike	\$12.40	
791F85 Fin	Screw Pack - ANSI Strike	\$4.40	
791F86 Fin	Spanner Head crew Pack - ANSI Strike	\$12.40	
791F87 Fin	Torx Head Screw Pack - ANSI Strike	\$12.40	
<b>Strikes:</b>			
796F43	Standard Strike	\$12.05	
240L08018	ANSI Strike 1-3/4" Door	\$18.30	
240L08020	ANSI Strike 2" Door	\$19.30	
240L08022	ANSI Strike 2-1/4" Door	\$19.30	
466F279	Strike Box	\$9.00	
120F768	ANSI Wrought Strike Box	\$4.40	

### DL3000 SERIES DEADLOCKS

PART NO.	DESCRIPTION	LIST PRICE	SOLD IN MULT. OF
261F29-8	Allen wrench 5/64"	\$2.50	10
467F36	Bolt front	\$15.20	1
467F34-5	Cylinder housing	\$47.70	1
467F33-8	Cylinder housing screw	\$1.30	20
480F70-8	Screw pack for ANSI strike	\$2.10	20
480F69	Screw pack for strikes 424F83 and 394F19	\$3.00	20
283F81	Collar Base / Rose	\$43.40	1
<b>Strike, 2-3/4" x 1-1/8</b>			
424F83-8	605, 606, 611, 612, 613, 618, 619, 625, 626	\$27.20	1
		\$16.20	1
		\$20.20	1
394F19-8	Strike, 3-1/2" x 1-1/8"	\$18.40	1
<b>Strike, ANSI</b>			
423L71	611,613, and all other finishes	\$25.40	1
416F38	Security collar	\$39.10	1
467F35-8	Bolt, less front -2-3/4" B.S.	\$40.10	1
693F20-8	Bolt, less front -2-3/8" B.S.	\$40.10	1
467F37-8	Strike box	\$5.50	1
496F71-8	Strike box	\$4.70	1

# ED4000/ED5000 Series Pushpad Exit Devices

DEVICE PARTS			DEVICE PARTS			
PART NO.	DESCRIPTION	LIST PRICE	PART NO.	DESCRIPTION	LIST PRICE	
<b>ACTIVE HEAD (FIELD REVERSIBLE, WHERE HANDED)</b>			<b>DELAYED EGRESS PC BOARDS</b>			
650F37-8	ED4200	\$230.00	704F269	DEED PC BD SA 36" NFPA-15	\$1,292.00	
681F61-8	ED4200S	\$246.00	704F279	DEED PC BD SA 36" NFPA-30		
650F41-8	ED4400 LHR	\$242.00	704F479	DEED PC BD SA 36" BOCA-15		
650F40-8	ED4400 RHR		704F489	DEED PC BD SA 36" BOCA-30		
650F46-8	ED4800 LHR	\$252.00	704F569	DEED PC BD SA 48" NFPA-15		
650F45-8	ED4800 RHR		704F579	DEED PC BD SA 48" NFPA-30		
650F35-8	ED5200	\$230.00	704F589	DEED PC BD SA 48" BOCA-15		
650F36-8	ED5200A	\$242.00	704F599	DEED PC BD SA 48" BOCA-30		
706F03-8	ED5202 RHR	\$270.00	<b>COVER, BAR 605, 606, 611, 612, 613, 619, 625, 626, 629, 630</b>			
706F04-8	ED5202 LHR		650F07	36"		\$46.00
706F05-8	ED5202A RHR	\$282.00	650F08	48"	\$50.00	
706F06-8	ED5202A LHR		<b>COVER, END</b>			
681F60-8	ED5200S(A)	\$246.00	<b>ED5000DB</b>			
706F07-8	ED5202S(A) RHR	\$286.00	650F93	605, 606, 611, 612, 613, 619, 625, 626, 629, 630	\$332.00	
706F08-8	ED5202S(A) LHR		<b>ED4000 36" cyl. dogging</b>			
650F39-8	ED5400(A) LHR	\$242.00	650F14	605, 606, 611, 612, 613, 619, 625, 626, 629, 630	\$142.00	
650F38-8	ED5400(A) RHR		<b>ED4000 36" standard</b>			
650F42-8	ED5600(A)	\$230.00	650F13	605, 606, 611, 612, 613, 619, 625, 626, 629, 630	\$140.00	
706F09-8	ED5602(A) RHR	\$270.00	<b>ED5000 36" cyl. dogging</b>			
706F10-8	ED5602(A) LHR		650F12	605, 606, 611, 612, 613, 619, 625, 626, 629, 630	\$142.00	
650F44-8	ED5800(A) LHR	\$252.00	<b>ED5000(A) 36" standard</b>			
650F43-8	ED5800(A) RHR		650F11	605, 606, 611, 612, 613, 619, 625, 626, 629, 630	\$140.00	
<b>ARMORED FRONT 605, 606, 611, 612, 613, 619, 625, 626, 629, 630</b>			<b>All 48" standard</b>			
650F06	ED5600	\$16.00	650F15	605, 606, 611, 612, 613, 619, 625, 626, 629, 630	\$152.00	
<b>BAR &amp; CARRIER ASSEMBLY</b>			<b>All 48" cyl. dogging</b>			
650F24-8	All 48"	\$267.00	650F16	605, 606, 611, 612, 613, 619, 625, 626, 629, 630	\$154.00	
650F23-8	ED4000 36"	\$253.00	<b>COVER, TOP &amp; BOTTOM LATCH</b>			
650F22-8	ED5000 36"		<b>ED4400, ED5400(A)</b>			
<b>BAR CAP</b>			<b>NO FINISH</b>			
650F18-9	Black nylon	†Order 10-	650F64	605, 606, 611, 612, 613, 619, 625, 626, 629, 630	\$77.00	
<b>BOTTOM BOLT CASE</b>			<b>NO FINISH</b>			
650F58-8	ED4400, ED5400	\$41.00	<b>CYLINDER DOGGING KIT</b>			
650F59-8	ED5400A	\$45.00	<b>ED4000 36" bar</b>			
<b>BOTTOM BOLT PACKET</b>			<b>NO FINISH</b>			
650F77-8	ED4800	\$123.00	653F13	605, 606, 611, 612, 613, 619, 625, 626, 629, 630	\$138.00	
698F03-8	ED5800(A)	\$109.00	<b>ED5000 36" bar</b>			
<b>BOTTOM RAIL</b>			<b>NO FINISH</b>			
650F21	48"	\$170.00	653F12	605, 606, 611, 612, 613, 619, 625, 626, 629, 630	\$138.00	
	606, 612, 630		\$187.00	<b>All 48" bar</b>		
	605, 613			653F14	605, 606, 611, 612, 613, 619, 625, 626, 629, 630	\$146.00
	611, 625, 626, 629		<b>DOGGING ASSEMBLY</b>			<b>NO FINISH</b>
<b>BOTTOM ROD &amp; COUPLER ASSEMBLY</b>			<b>NO FINISH</b>			
650F79-8	ED4800, ED5800(A)	\$92.00	650F96-8	Cylinder type	\$36.00	
<b>BOTTOM ROD &amp; END PIN ASSEMBLY 605, 606, 611, 612, 613, 618, 619, 625, 626, 629, 630, 722</b>			650F52-8	Hex Key type		
649F99 fin	Surface devices	\$148.00	<b>DOGGING CYLINDER NUT</b>			
<b>CARRIER BAR NO FINISH</b>			<b>NO FINISH</b>			
650F99-8	Internal	\$14.00	697F862	Dogging Cylinder Nut	\$14.00	
<b>COVER, ACTIVE HEAD 605, 606, 611, 612, 613, 619, 625, 626, 629, 630</b>						
650F00	ED5200	\$187.00				
650F03	ED4200					
681F63	ED4200S					
650F04	ED4400					
650F05	ED4800					
681F62	ED5200S					
706F15	ED5602 RHR		\$197.00			
706F16	ED5602 LHR					

†Sold only in multiples of the number indicated. Price is each.

# ED4000/ED5000 Series Pushpad Exit Devices

## DEVICE PARTS (Cont'd)

PART NO.	DESCRIPTION	LIST PRICE
<b>DOGGING CYLINDER SLEEVE</b>		
650F959	Dogging Cylinder Sleeve	\$8.00
<b>DOGGING HOLE PLUG</b>		
650F27-9	Dogging Hole Plug †Order 50-	\$0.70
<b>DOGGING KEY, HEX</b>		
656F40-8	5/32"	\$3.00
<b>END CAP RETROFIT KIT</b>		
704F66	End Cap Retrofit Kit	\$77.00
<b>END CAP</b>		
704F62	End Cap	\$57.00
710F00M	Flush End Cap Retrofit Kit (M110)	\$77.00
<b>END CLAMP PACKET</b>		
704F658	ED4200(S), ED5200S(A)	\$12.00
704F64-8	ED4000, ED5000(A)	
<b>FLUSH STRIKE TRANSOM BRACKET</b>		
650F87-8	Flush strike transom brkt., ED5400(A)	\$50.00
<b>LATCH PACKET</b>		
654F21-8	Latch pkt, ED4400, ED5400 †Order 10-	\$4.00
<b>MORTISE LOCK BODY</b>		
655F48-8RR	ED5610 knob - RHR	\$305.00
655F48-8LR	ED5610 knob - LHR	
650F69-8RR	ED5602, ED5610, ED5655 lever - RHR	\$311.00
650F69-8LR	ED5602, ED5610, ED5655 lever - LHR	
678F00-8RR	ED5610, ED5655 thumbpiece - RHR	\$315.00
678F00-8LR	ED5610, ED5655 thumbpiece - LHR	
650F67-8RR	ED5650,57 knob, lever/thumbpiece - RHR	\$311.00
650F67-8LR	ED5650,57 knob, lever/thumbpiece - LHR	
710F31-8LR	ED5634L - LHR	
710F31-8RR	ED5634L - RHR	
710F32-8LR	ED5634L - LHR - M91	\$541.00
710F32-8RR	ED5634L - RHR - M91	
710F33-8LR	ED5634L - LHR - M93	\$526.00
710F33-8RR	ED5634L - RHR - M93	
<b>ADAPTER ASSEMBLY, MORTISE</b>		
706F46-2	ED5602(A)	\$30.00
<b>MOUNTING PACKET</b>		
650F57-8	ED4400, ED5400(A)	\$83.00
654F20-8	Non-rated, wood door †Order 20-	\$3.00
<b>900, WS700 &amp; FE700 SERIES MULLION PACKETS</b>		
<b>TOP RETAINER AND SCREW PACKET</b>		
713F518	907, 908, 910, 907A, 908A	\$195.00
713F938	FE707A, FE708A	\$203.00
713F948	907BKM, 908BKM, 910KM	\$195.00
713F958	WS707AKM, WS708AKM	\$203.00
<b>BOTTOM RETAINER AND SCREW PACKET</b>		
713F528	907, 908, 910, 907A, 908A	\$129.00
713F998	FE707A, FE708A	\$203.00
713F988	907BKM, 908BKM, 910KM	\$129.00
713F908	WS707AKM, WS708AKM	\$203.00
<b>LOCKING MECHANISM PACKET</b>		
744F258	907BKM, 908BKM, 910KM	\$422.00
744F208	WS707AKM, WS708AKM	\$438.00
<b>1-1/4" CYLINDER COLLAR PACKET†</b>		
447F43	907BKM², 908BKM², 910KM²	\$17.80
610F01	WS707AKM², WS708AKM²	\$28.50
<b>1-1/2" LFIC CYLINDER COLLAR PACKET†</b>		
609F37	907BKM², 908BKM², 910KM²	\$32.50
609F36	WS707AKM², WS708AKM²	\$30.50

Notes: 1. Cylinder collar packets contain a collar & spring washer.  
2. Specify finish when ordering packets.

PART NO.	DESCRIPTION	LIST PRICE
<b>ROD EXTENSION KIT (CONCEALED VERTICAL)</b>		
684F427	Rod Extension Kit, 24"	\$81.00
<b>ROD EXTENSION KIT (SURFACE VERTICAL)</b>		
<b>Rod Extension Kit, 2"</b>		
655F15	605, 606, 612, 613, 619, 625, 626, 629, 630	\$80.00
<b>Rod Extension Kit, 6"</b>		
655F16	605, 606, 612, 613, 619, 625, 626, 629, 630	\$92.00
<b>Rod Extension Kit, 12"</b>		
655F17	605, 606, 612, 613, 619, 625, 626, 629, 630	\$96.00
<b>Rod Extension Kit, 24"</b>		
684F42	605, 606, 612, 613, 619, 625, 626, 629, 630	\$98.00
<b>ROD GUIDE COVER</b>		
<b>Rod Guide Cover</b>		
650F63	605, 606, 612, 613, 619, 625, 626, 629, 630	\$31.00
<b>ROD GUIDE PACKET</b>		
<b>Rod Guide Packet</b>		
650F62	606, 612, 613, 626	\$19.10
<b>SCREWS</b>		
605, 606, 611, 612, 613, 619, 625, 626, 629, 630		
429F41	Pack, Armored Front †Order 20- 606, 612, 613, 619	\$4.00
704F63	Packet, Cover 606,612,613,630 finish	\$3.60
656F66-8	#10-24 x 1/4" PH †Order 100-	\$0.50
650F53-8	Dogging Assembly †Order 50-	\$0.62
650F51-8	Latch head to carrier †Order 50-	\$0.62
650F28-8	Touch bar caps (622 only) †Order 50-	\$0.72
650F50-8	Trim slide †Order 100-	\$0.40
<b>SCREW PACK, TORX® PIN</b>		
701F60	ED4200(S), ED4800, ED5200(S), ED5800	\$16.30
701F61	ED4400, ED5400, ED5470	\$16.30
701F62	ED5600	\$17.30
701F63	ED5860	\$16.30
<b>SEX NUT PACKET</b>		
652F29-8	Sex Nut Packet (4 sex nuts)	\$18.40
<b>SHIM KIT</b>		
697F33-8	ED5200(S)(A), ED5600(A), ED5800(A)	\$105.30
697F34-8	ED5400(A)	\$125.30
697F35-8	ED4200(S), ED4800	\$105.30
697F36-8	ED4400	\$125.30
<b>SPRING, TOUCH PAD</b>		
656F41	Spring, Touch Pad	\$2.60
<b>STRIKE PACKET 622 FINISH ONLY</b>		
650F88-8	bottom for 1/2" threshold (S09)	\$57.50
650F31-8	ED4200(S), ED4800	\$55.50
730F778	ED5200(S)(A), ED5202(S)(A)	\$79.50
650L65	ED5600	\$34.80
650L65-7020	Mortise strike for ED5602(A)	\$34.80
653L15-7014	Mortise strike for doors with astragal	\$31.80
655F71-8	ED5200 x S02	\$57.50
653L16-3016	open back straight lip for 1-3/4" door	\$87.50
653L16-3020	open back straight lip for 2-1/4" door	\$117.50
653L18-3016	open back curved lip for 1-3/4" door	\$87.50
653L18-3020	open back curved lip for 2-1/4" door	\$117.50

†Sold only in multiples of the number indicated. Price is each.



**DEVICE PARTS (Cont'd)**

PART NO.	DESCRIPTION	LIST PRICE	PART NO.	DESCRIPTION	LIST PRICE
<b>TOP LATCH</b>			<b>TOP STRIKE PACKET</b>		
650F73-8	Top Latch & Bracket Assembly, ED4800	\$179.20	650F54-8	Top strike packet	\$74.90
650F71-8	Top Latch & Bracket Assembly, ED5800	\$181.20	681F70-8	Top strike packet for ED5470B	\$28.20
650F72-8	Top Latch & Bracket Assembly, ED5800A	\$193.20	681F77-8	Top strike for ED5860B	\$32.20
650F55-8	Top Latch, ED4400, ED5400, ED5470	\$167.20	<b>TOUCH PAD CAP 622 ONLY</b>		
650F56-8	Top Latch, ED5400A, ED5470B	\$177.20	650F10-5	Touch Pad Cap, front	\$32.20
681F76-8	Top Latch, ED5860B	\$203.20	650F09-5	Touch Pad Cap, rear	\$26.20
681F71-8	Top Mtg. Plate for ED5470B	\$50.00	<b>TRIM SLIDE NO FINISH</b>		
<b>TOP ROD NO FINISH</b>			650F49-8	Trim Slide Retainer †Order 10-	\$3.60
650F81-8	Top Rod Tube, concealed	\$91.20	650F48-9	Trim Slide, ED4000	\$5.60
650F80-8	Top Rod, concealed	\$77.20			
	<b>Top Rod, surface</b>				
650F60 fin	605, 606, 611, 612, 613, 619, 625, 626, 629, 630	\$121.20			

**TRIM PARTS, GRIPS**

DESIGN	STANDARD PART NO.	STANDARD PRICE 606, 612, 630	STANDARD PRICE 605, 611, 613, 619 625, 626, 629	KNURLED PART NO. ADD \$65.00 TO STD. PRICE	ABRASIVE PART NO. ADD \$42.00 TO STD. PRICE
A7	652F78			652F79	652F80
C7	652F66			652F67	652F68
D7 RHR	652F69			652F70	652F71
D7 LHR	652F72			652F73	652F74
E7	652F57			652F58	652F59
G7	656F45			656F48	656F51
L7	652F60			652F61	652F62
N7	652F75			652F76	652F77
PR7	652F81			652F82	652F83
R7	652F63			652F64	652F65
A7M	653F71			653F72	653F73
C7M	653F59			653F60	653F61
D7M RHR	653F62			653F63	
D7M LHR	653F65			653F66	
E7M	653F50				
G7M	656F44	\$159.00	\$159.00	656F47	656F50
L7M	653F53			653F54	653F55
N7M	653F68			653F69	653F70
PR7M	653F74			653F75	653F76
R7M	653F56			653F57	
A8	653F05				
C8	652F93				652F95
D8 RHR	652F96				
D8 LHR	652F99				
E8	652F84			652F85	652F86
G8	656F46			656F49	656F52
L8	652F87			652F88	652F89
N8	653F02			653F03	653F04
PR8	653F08			653F09	653F10
R8	652F90				652F92
08, 014	656F53			n/a	n/a

†Sold only in multiples of the number indicated. Price is each.

**TRIM PARTS, GRIPS, ESCUTCHEONS (Cont'd)**

DESIGN	STANDARD PART NO.	STANDARD PRICE 605, 606, 611, 612, 613, 619, 625, 626, 629, 630	KNURLED PART NO. ADD \$65.00 TO STD. PRICE	ABRASIVE PART NO. ADD \$42.00 TO STD. PRICE
A9	677F16	\$179.00	652F79	652F80
C9	677F15		652F67	652F68
D9 RHR	677F26		652F70	652F71
D9 LHR	677F27		652F73	652F74
E9	677F13		652F58	652F59
L9	677F04		652F61	652F62
N9	677F05		652F76	652F77
PR9	677F28		652F82	652F83
R9	677F14		652F64	652F65
A9M	653F71		653F72	653F73
C9M	653F59		653F60	653F61
D9M RHR	653F62		653F63	
D9M LHR	653F65		653F66	
E9M	653F50			
L9M	653F53		653F54	653F55
N9M	653F68		653F69	653F70
PR9M	653F74		653F75	653F76
R9M	653F56		653F57	

DESIGN	PART NO.	LIST PRICE 605, 606, 613, 625, 626
FR9 RHR	698F64	\$179.00
FR9 LHR	698F66	
TS9	698F31	
Z9 RHR	698F68	
Z9 LHR	698F70	
M9	698F33	\$163.00
FR9M RHR	698F65	\$179.00
FR9M LHR	698F67	
TS9M	698F32	
Z9M RHR	698F69	
Z9M LHR	698F71	
M9M	698F34	
		\$163.00

PART NO.	DESCRIPTION	605, 606, 611, 612, 613, 613E, 619, 625, 626, 629, 630
656F58	x8 cyl. x knob	\$130.00
656F59	x8 cyl. x lever	\$138.00
656F60	x8 plain x knob or thumbturn	\$130.00
656F61	x8 plain x lever	\$138.00
651F00	F450	\$124.00
651F01	F457	
651F10	O14, T14 bottom	\$57.00
656F62	O1410 top	\$124.00
656F63	O1455/59 top	
651F09	T1410 top	\$113.00
651F06	T1450 top	\$109.00
651F08	T1455, T1459 top	\$113.00
651F04	T1457 top	\$109.00
733F41	F950	\$179.00
733F42	F957	
733F43	9M10, M50	
733F05	L910, G910	
733F44	L950, G950	
733F45	L955, G955	
783F06	L955, G955, L959, G959	
733F46	F9M57	
733F47	L957, G957	
733F48	DL910	
733F49	DL9M10, DL9M50	
733F50	DL955, DL959	
733F51	DL9M55, DL9M57	
733F52	DL957	
733F53	DL950	

†Sold only in multiples of the number indicated. Price is each.

# ED4000/ED5000 Series Pushpad Exit Devices

## TRIM PARTS (Cont'd)

PART NO.	DESCRIPTION	LIST PRICE
<b>BUSHING, NYLON</b> NO FINISH		
652F23-9	Bushing, Nylon †Order 20-	\$4.00
<b>CLUTCH LEVER</b> NO FINISH		
651F53-8	Clutch Lever †Order 20-	\$3.50
<b>COTTER PIN</b> NO FINISH		
677F09-8	Cotter Pin †Order 100-	\$0.40
<b>COVER PLATE</b> NO FINISH		
651F85-8	Cover Plate, x8, O14, T14	\$13.00
<b>CYLINDER COLLAR</b>		
	various	see page 4
<b>GEAR &amp; BLACK HOUSING ASSEMBLY</b> NO FINISH		
651F63-8	Gear & Black Housing Assembly (all but x750)	\$15.00
651F64-8	Gear, levers	\$6.00
655F54-8	Gear, dummy lever	
<b>HEX NUT/BUSHING</b> NO FINISH		
651F39-8	Hex Nut/Bushing for spring	\$4.60
<b>HOUSING</b> NO FINISH		
651F67-5	Housing & Cam Assembly, x755, T1355	\$42.00
651F96-5	Housing & Cam Assembly, x855, x859, O/T1455/59	\$34.00
651F42-5	Housing, Cylinder, F2, F3, T1357, O/T1457	\$7.00
651F54-5	Housing, Tailpiece Assembly	\$29.00
706F01-5	Housing, Cylinder ED5202(S)(A), ED5602(A)	\$8.00
706F00-5	Housing, Cylinder, Trim, ED5202(S)(A), ED5602(A)	\$41.00
<b>HUB</b> NO FINISH		
652F22-8	Hub	\$24.00
651F65-5	Hub, lever	\$7.00
656F64	Hub, G knob	\$7.40
<b>LOCK WASHER</b> NO FINISH		
651F44-8	for screw post †Order 50-	\$0.40
<b>NUT</b> NO FINISH		
651F88-8	Nut, Cover Plate †Order 50-	\$0.48
651F92-8	Nut, Spring Post	\$5.00
<b>PIN</b> NO FINISH		
651F83-8	Pin, Clutch Lever †Order 50-	\$1.30
651F98-8	Pin, Groove, 5/32" x 1-1/8" for T1410, T1455, T145 †Order 50-	\$1.00
651F58-7	Pin, Thumbpiece, T13M †Order 20-	\$1.38
<b>PULL</b>		
651F37-2	Pull, Offset - 605, 606, 611, 612, 613, 619, 625, 626, 629, 630	\$133.00
651F36-2	Pull, Straight - 605, 606, 611, 612, 613, 619, 625, 626, 629, 630	\$109.00
<b>RACK &amp; TAILPIECE ASSEMBLY</b> NO FINISH		
651F82-8	x810, x855, x859, O14, T14	\$85.00
652F21-8	x850	\$73.00
<b>RETAINER, CLUTCH LEVER PIN</b> NO FINISH		
651F89-8	Retainer, Clutch Lever Pin †Order 100-	\$0.30
<b>RETAINING RING</b> NO FINISH		
651F60-8	Retaining Ring, T13M †Order 50-	\$0.40
<b>ELECTRIFIED LOCKBODY USED WITH "SAF" &amp; "SEC" ED5600L DEVICES:</b>		
677F768LR 626	LOCK SA-L5 MORT.SAFE LHR	\$727.00
677F768RR 626	LOCK SA-L5 MORT.SAFE RHR	\$727.00
677F778LR 626	LOCK SA-L5 MORT.SEC. LHR	\$727.00
677F778RR 626	LOCK SA-L5 MORT.SEC. RHR	\$727.00
<b>SCREW</b> NO FINISH		
655F02-8	Screw, Cylinder Mounting †Order 100-	\$0.34
651F87-8	Screw, FHM-PH #8-32 x 7/16" †Order 50-	\$0.36

PART NO.	DESCRIPTION	LIST PRICE
<b>SCREW (CONT'D)</b> NO FINISH		
656F65-8	Screw, Function	\$0.46
651F41-8	Screw, RHM-PH #1/4-20 x 5/8" †Order 50-	\$0.38
651F50-8	Screw, Tailpiece Plate, PHT-T-PH #6 x 3/8 †Order 50-	\$0.46
<b>SCREW PACKET, MOUNTING</b>		
652F12-8	1-3/4" - 2" door - 606, 612, 613, 619, 626	\$7.90
652F10-8	1-3/4" - 2" door - 606, 612, 613, 619, 626	\$5.80
652F11-8	2-1/4" door - 606, 612, 613, 619, 626	\$5.80
652F13-8	2-1/4" door - 606, 612, 613, 619, 626	\$7.90
652F14-8	F3, T13 for 1-3/4" - 2" door - 606, 612, 613, 619, 626	\$10.50
652F15-8	F3, T13 for 2-1/4" door - 606, 612, 613, 619, 626	\$10.50
<b>SCREW POST</b> NO FINISH		
783F048	Screw Post	\$6.00
<b>SLIDER, THUMBPIECE</b> NO FINISH		
651F49-8	Slider, Thumbpiece	\$5.60
<b>SPINDLE BRACKET</b> NO FINISH		
652F04-8	Spindle Bracket, lever	\$6.00
<b>SPINDLE NUT</b> NO FINISH		
651F73-8	Spindle Nut, x7 †Order 20-	\$2.00
652F09-8	Spindle Nut, x7M lever †Order 50-	\$0.54
<b>SPINDLE WASHER</b> NO FINISH		
652F06-8	Spindle washer, G Knob	\$4.00
652F05-8	Spindle Washer, Levers	\$4.40
<b>SPRING</b> NO FINISH		
651F94-8	Spring, Extension	\$2.00
651F75-8	Spring, Grip Return, knob †Order 10-	\$4.00
651F61-8	Spring, Grip Return, lever, LHR (red)	\$4.10
651F62-8	Spring, Grip Return, lever, RHR (blue)	
651F93-8	Spring, Rack, lever †Order 50-	\$1.90
651F47-8	Spring, Thumbpiece, T13	\$4.50
678F02-8	Spring, Thumbpiece T13M	\$6.50
651F40-8	Spring, various trim †Order 20-	\$2.00
651F86-8	Spring, various trim †Order 50-	\$1.90
<b>TAILPIECE ASSEMBLY</b> NO FINISH		
677F06-8	1-3/4" door without shim kit	\$37.00
655F69-8	2" - 2-1/4" door or 1 3/4" door with shim kit - TH9 series trims	\$37.00
655F70-8	2" - 2-1/4" door or std. door with shim kit - All trims except TH9 series	\$37.00
<b>THIMBLE INSERT</b>		
651F38-9	Knob & thumbturn †Order 50-	\$0.50
118F29-9	Lever †Order 100-	\$0.30
<b>THUMBPIECE BRACKET</b>		
651F57-8	Thumbpiece Bracket, T13M	\$19.00
<b>THUMBPIECE TAB</b> NO FINISH		
651F56-8	Thumbpiece Tab, T13M	\$2.50
<b>THUMBPIECE</b> 605, 606, 611, 612, 613, 619, 625, 626, 629, 630		
566F50	Thumbpiece, T13, T14	\$45.00
566F51	Thumbpiece, T13M	\$51.00
<b>WASHER</b> NO FINISH		
651F70-8	Washer under tailpiece †Order 50-	\$0.56
651F84-8	Washer, Grip †Order 20-	\$2.40

**ACTIVE & INACTIVE CASES**

PART NO.	DESCRIPTION	LIST PRICE
<b>ACTIVE CASE ASSEMBLIES, COMPLETE</b>		
<b>LOCK BODY ASSEMBLY - CROSSBAR</b>		<b>SPECIFY HAND</b>

**No Finish**

424F42-8	MLE08 (ED 7600)	\$572.00
424F43-8	MLE09 (ED7600A)	

**STRIKES FOR CROSSBAR EXIT DEVICES**

PART NO.	DESCRIPTION	LIST PRICE
269F73	ED7000 LHR with dogging	\$816.00
269F74	ED7000 RHR with dogging	
269F75	ED7000 LHR less dogging	\$770.00
269F76	ED7000 RHR less dogging	

**VERTICAL ROD STRIKES 605, 606, 612, 613, 622, 626, 629**

392F24	Top	\$89.00
392F22	Top	\$70.00
392F28	Bottom flush	\$56.00
392F29	Bottom surface	\$48.00
176F65-3	Top bracket	\$48.00
304F33-7	Bottom 630 only	\$31.00
304F34-7	Bottom 630 only	\$48.00
352F04-2	Bottom	\$31.00
352F05	Top	\$56.00
361F91-3	Bottom flush	\$56.00
123F22	Bottom	
183F85-7	Top 630 only	
502F75	Bottom mortised	\$33.00
502F96	Surface	\$43.00

**ED7000 Series Crossbar Exit Devices**
**STRIKES FOR CROSSBAR EXIT DEVICES (Cont'd)**

PART NO.	DESCRIPTION	LIST PRICE
<b>CONCEALED VERTICAL ROD STRIKES 605, 606, 612, 613, 622, 626</b>		

503F52	Bottom Strike	\$57.00
503F53-3	Fire Rated Bottom Strike	\$57.00

**RIM EXIT DEVICE STRIKES 605, 606, 612, 613, 622, 626**

142F43	Adj. Packet	\$131.00
467F73-3	Pack, rim vert. rod	\$89.00
300F71	Packet	\$112.00
499F59-8	Adj.	\$83.00

**MORTISE STRIKES 605, 606, 612, 613, 619, 622, 625, 626**

240L50	Stainless Mortise - LHR 629, 630 only	\$47.00
240L51	Stainless Mortise - RHR 629, 630 only	
411L63	Open Back - RHR	See page 343
411L62	Open Back - LHR	See page 343

**LOW PROFILE EXIT DEVICE STRIKES**

416F35-5	Strike 622 689, 690, 691	\$43.00
436F03-8	Strike, bottom	\$17.40
487M048-589	Top Rod (for 10' Doors)	\$123.50
463F91-8	Flush Bottom Strike	\$20.40

**DEVICE PARTS**

PART NO.	DESCRIPTION	LIST PRICE	PART NO.	DESCRIPTION	LIST PRICE
095F35-1	Strap/Stabilizer for Mullion	\$28.20	154F96-6	Clamp	\$22.00
120F55-8	Screw	\$2.60	158F52-8	Cylinder Retainer, MR	\$12.00
122F18-8	Mounting Bracket	\$28.20	158F53-8	Cylinder Retainer, regular	\$5.00
122F24-8	Washer †Order 100-	\$0.20	158F54-8	Washer	\$2.00
122F41-3	Lower Rod Guide	\$11.00	158F55-8	Stud	\$6.00
122F50-8	Lower Bolt Tube Sub Assembly	\$80.00	164F32-9	Nylon Washer †Order 50-	\$0.40
122F51-8	Bottom Guide Sub Assembly	\$76.00	166F34-7	Latch Pin	\$5.00
122F56-8	Locking Lever	\$21.00	171F89-6	Top Plate Sub Assembly	\$75.00
122F57-8	Locking Lever	\$15.00	171F90-9	Insert	\$19.00
122F59-3	Locking Lever Spring	\$24.00	173F44-6	Bottom Plate	\$34.00
122F60-8	Locking Hub	\$12.00	173F45-6	Bottom Filler Plate	\$30.00
122F61-8	Locking Hub	\$6.00	173F69-8	Stud	\$2.00
122F63-9	Spacer Washer (Nylon)	\$2.00	173F72-8	Nut	\$5.00
122F64-3*	Handle Lever	\$112.00	174F79-7	Top Plate & Stud Sub Assembly	\$197.00
123F53-8	Dogging Key, 3/16" hex	\$3.30	174F80-7	Top Plate & Stud Sub Assembly	
129F49-9	Sound Deadener	\$7.00	175F51-8	Rod Insert	\$19.00
129F84-8	Cylinder Nut	\$7.00	183F74	Top Latch Sub Assembly (with top rod doors 6'4" to 8'6")	\$358.00
134F05	Cylinder Collar	See page 339	183F75	Top Latch Sub Assembly (with top rod door 8'6" to 10'8")	\$358.00
140F52-8	Stud †Order 20-	\$1.10	184F57	Thumbpiece	\$40.00
141F41-8	Springwasher †Order 20-				
141F84*	Case housing, active & inactive	\$141.00	184F82-5	Shim	\$19.00
141F86*	Case (Active - No Bot. Rod)				
141F87*	Active Case				
141L54-8	Reinforcing Tube	\$137.00	184F94-8	Jam Nut	\$6.00
141L59	<b>Crossbar</b> 605, 606, 611, 612, 613, 619, 622, 625, 626, 629, 630	\$310.00	184F97*	Thumbpiece	\$44.00
142F16*	Case Sub Assembly	\$191.00	185F55-8	Lifting Lever	\$14.00
142F44*	Adj. Strike	\$72.00	186F23	Cyl. Collar	\$36.00
143F24-8	Spring †Order 50-	\$1.00	187F21-3	<b>Latch</b> 605, 606, 611, 613, 619, 622, 625, 626, 629, 630	\$148.00
143F25	Rollback	\$14.00	187F88-7	Latch Spring RH	\$2.00
143F26-5	Slide	\$50.00	187F89-7	Latch Spring LH	
143F42*	Thumbpiece	\$47.00	Ø 195F67	<b>Cylinder Housing</b> (for master ring) 605, 606, 611, 612, 613, 619, 622, 625, 626	\$87.00
143F43*	Thumbpiece				
143F52*	Thumbpiece				
143F83-3	Stud	\$6.00	207F55-8	Screw Packet	\$37.00
145F54-3*	Strike Plate	\$78.00	207F64*	Screw Packet	
147F83-8	Lazy Cam	\$3.00	207F68*	Screw Packet	\$44.00
147F84-9	Washer (White Nylon)	\$3.00	207F69*	Screw Packet	\$54.00
147F87-8	Cam	\$4.00	376F37*	Sex Nut (For 1-3/4 & 2" doors)	\$6.00
147F88-8	Slide Spring †Order 50-	\$1.00	209F55*	Screw Packet	\$48.00
148F15-7	Release Pkg. 613, 630	\$14.00	213F10-7	<b>Top Strike Ass'y</b> (reveal 5-1/2" - 8") 629, 630	\$67.00
148F17	<b>Cover Retaining Screw</b> 606, 611, 612, 613, 619, 622, 625, 626, 629, 630	\$12.00			
148F22-8	Pin	\$2.00			
148F36-7	Release Plunger Sub Assembly	\$22.00			
148F44-8	Mounting Wrench	\$5.00			

**DEVICE PARTS (Cont'd)**

PART NO.	DESCRIPTION	LIST PRICE
213F11-7	Top Strike S/A (reveal less 5-1/2")	\$87.00
	629, 630	
200F16-8	Screw 12-24 x 1/2" FHMS	\$2.00
220F49-8	Screw 1/4-20 x 2" FHMS	\$1.70
220F72-2	Screw 12-24 x 1/2" FHMS-PH †Order 20-	\$1.60
220F75	<b>Screw 1/4-20 x 5/8" FHMS-PH</b>	\$1.60
	606, 619, 622, 625, 626, 630	
	605, 611, 512, 613, 629	\$3.00
220F77-8	<b>Screw</b> 622, CDC, MTD, 613	\$1.70
220F82-7	Screw 1/4-20 x 1" FHMS-PH	\$3.10
220F84-8	Screw 12-24 x 1-1/4" FHMS-PH	\$1.00
220F85*	Screw 1/4-20 x 1-1/4" FHMS-PH x Anchor	\$2.90
221F94-8*	Mounting Screw	\$3.00
222F71*	Throughbolt	
224F34-8	Screw 12 x 1" FHWS †Order 20-	\$1.22
224F39-2	Screw 14 x 1-1/4" FHWS †Order 20-	
224F44-8	Screw 14 x 1-1/2" FHWS	\$2.90
224F50-8	Screw 14 x 2" FHWS †Order 20-	\$1.22
225F99-8	Screw 12 x 1-1/2" OHWS-PH	\$2.30
228F18-8	Roll Pin †Order 100-	\$0.30
228F49-7	Roll Pin (79-028-125-0343)	\$1.46
228F51-7	Roll Pin (79-028-125-0500 St'd) †Order 100-	\$0.36
228F52-8	Roll Pin †Order 100-	\$0.34
228F55-8	Roll Pin 1/8 x 3/4" †Order 100-	\$0.36
228F68-7	Roll Pin 156 x 9/16" †Order 50-	\$0.58
228F80-8	Roll Pin 187 x 3/4" †Order 100-	\$0.40
228F81-7	Roll Pin 187 x 1-15/16" †Order 20-	\$0.84
228F84-7	Roll Pin 187 x 1-3/8" †Order 20-	\$0.80
243F76-9	Stop Nut †Order 20-	\$0.90
243F79-8	Spring Lock Washer †Order 100-	\$0.34
243F80-8	1/4-20 x 5/8" FRMS-PH	\$2.90
243F85	Top Cover Sub Assembly	\$142.30
	605, 606, 611, 612, 613, 619, 625, 626, 629, 630	
249F33*	1/4-20 NC-2A x 1-1/4" Lg. Phillips OHMS	\$3.60
253F11-8	Drive Screw †Order 100-	\$0.30
254F73	<b>Screw 8-32 x 3/8" OHMS-PH</b>	\$2.40
	605, 606, 611, 612, 613, 619, 625, 626, 630	
255F41*	Screw 12-24 x 2" FHMS-PH	\$4.50
261F28-8	Screw 8-32 x 3/8" HSS Cone-SOC	\$2.90
261F29-8	Hex Key 5/64" †Order 10-	\$2.50
261F31-8	<b>Screw 5/16-24 x 1-1/2" FHMS-SOC</b>	\$3.30
	605, 611, 612, 613, 619, 625, 626, 630	
261F54	Cylinder Collar	\$27.50
261F65-8	Screw 1/4-20 x 1/2" PHMS	\$2.50
262F90-1	River 3/32" x 5/32" †Order 100-	\$0.34

PART NO.	DESCRIPTION	LIST PRICE
264F95-8	Screw 12-24 x 7/8" RHMS-PH	\$0.80
	(Metal Doors) †Order 20-	
267F34-8*	Mounting Screw †Order 20-	
268F64-7	Washer †Order 50-	\$0.70
268F84-8	Screw 6-32 x 5/8" RHMS †Order 20-	\$0.80
268F87-8	Retainer Ring †Order 20-	
269F04-8	Cotter Pin †Order 50-	\$0.70
269F05-8	Lockwasher †Order 100-	\$0.34
269F08	<b>Screw 8-32 x 3/8" FHMS-PH</b>	\$0.80
	605, 606, 611, 613, 619, 625, 626, 630	
269F09-8	Screw 1-32 x 1/4" OHMS-PH †Order 100-	\$0.46
<b>Lever</b>		
269F31	605, 606, 611, 612, 619, 613, 619, 625, 626	\$292.10
269F32	605, 606, 611, 612, 619, 613, 619, 625, 626	
<b>COVER</b>		
269F33	605, 606, 611, 612, 613, 619, 625, 626, 629, 630	\$302.90
269F34	605, 606, 611, 612, 613, 619, 625, 626, 629, 630	\$302.90
269F35	605, 606, 611, 612, 613, 619, 625, 626, 629, 630	\$302.90
269F36	<b>Active Case Less Cover, ED7200 RHR &amp; LHR</b>	\$326.90
	605, 606, 611, 612, 613, 619, 625, 626, 629, 630	
269F37-8	Hub	\$39.00
269F39-3	Latch Retractor	\$35.00
269F40-3	Latch Retractor	\$39.00
269F41-3	Slide	\$47.00
269F42	<b>Inactive Case S/A, all ED7000</b>	\$324.90
	605, 606, 611, 612, 613, 619, 625, 626, 629, 630	
269F46-8	Hold Back Sleeve	\$39.00
269F47-9	Nyliner	\$3.10
269F48-8	Lever Pivot	\$2.70
269F49-9	Bushing	\$3.90
269F52-8	Hub Shank	\$5.10
269F53-8	Latch Spring	\$3.10
269F54-9	Button	\$0.90
269F55-9	Washer †Order 50-	\$0.58
269F56-9	Washer †Order 50-	
269F57-8	Spring Washer	\$6.00
269F58-7	Latch Pin	\$2.80
269F60-8	Inner Spring	\$6.00
269F91*	Screw Packet	\$89.10
269F92*	Screw Packet	\$66.10
270F01*	Screw Packet	\$89.10
270F02*	Screw Packet	\$68.10
270F11*	Through Bolt	\$3.50
282F32-5	Caulking Anchor	\$4.20
282F35-7	Caulking Anchor	\$3.10
284F67*	Lever RH	\$115.10

\*Specify Finish. Ø Subject to availability.

† Sold only in multiples of the number indicated. Price is each.

**DEVICE PARTS (Cont'd)**

PART NO.	DESCRIPTION	LIST PRICE	PART NO.	DESCRIPTION	LIST PRICE
284F68*	Lever LH	\$115.10	351F72	<b>Bottom Latch Cover</b>	\$220.00
284F69*	Lever RH			605, 606, 611, 612, 613, 619, 625, 626, 629, 630	
284F70*	Lever LH				
284F78	Lifting Finger RH	\$9.60	351F73	<b>Top Latch Cover</b>	\$232.00
284F79	Lifting Finger LH			605, 606, 611, 612, 613, 619, 625, 626, 629, 630	
284F97-7	Roll Pin †Order 50-	\$0.58	351F79-7	Top Latch Sub Assembly	\$52.00
286F91	<b>Lever S/A LH (Inactive)</b>	\$187.10	351F80-7	Roll Pin †Order 50-	\$0.70
	605, 606, 611, 612, 613, 619, 625, 626				
286F92	<b>Lever S/A RH (Inactive)</b>	\$187.10	351F82-3	Top Latch Backplate	\$96.00
	605, 606, 611, 612, 613, 619, 625, 626				
287F96-8	1/4-20 x 13/16" FRMH-PH	\$3.80	351F83-3	Top Latch Slide	\$9.00
291F49-8	Stop Plate	\$23.90	351F84-9	Spacer	
291F57-8	Screw 10-31 x 1" FHM-PH †Order 50-	\$0.70	351F85*	Top Latch Sub Assembly No Cover	\$369.00
292F41-3*	Strike	\$114.00	351F86-7	Bottom Latch	\$96.00
293F18-3	Slide Assembly	\$106.00	351F87-3	Latch Link	\$94.00
304F65-7	<b>Screw 12-24 x 7/8" OHU-MS-PH (1-3/4", 2" Doors)</b>	\$1.60	351F88-3	Bottom Latch Backplate	\$96.00
	622, 629, 630				
304F66-7	Screw 12-24 x 1-1/8" OHU-MS-PH (2-1/4" Doors)	\$4.50	351F89-7	Spring †Order 20-	\$0.80
305F07	Screw 12-24 x 3/4" FRHMS-PH †Order 20-	\$0.90	351F90-7*	Bottom Latch Sub Assembly	\$332.00
305F72-8	Lower Bolt Sub Assembly - includes Bottom Rod	\$429.90	351F98-8	Rod Connector Sub Assembly	\$5.00
305F73-8	Guard Plate	\$30.40	352F02-1	Drive Rivet †Order 20-	\$0.90
306F06-8	Screw 10-24 x 5/16" RHMS-PH †Order 20-	\$0.90	352F03-8	Pin	\$4.70
306F07-8	Spring Lockwasher †Order 100-	\$0.20	352F06-8	1/4-20 x 3/4" BHUMS-PH Screw †Order 20-	\$0.80
306F15-8	Plate	\$2.10	352F07*	2-1/2" x 14 OHWS-PH Screw	\$1.04
306F20-8	Backplate Sub Assembly	\$161.80	361F30-8	Anchor	\$5.70
306F22-8	Center Rod	\$8.10	362F49-8	Nut	\$22.00
314F52-8	Screw HS-O-SK 3/8" - 16 x 1/2" †Order 50-	\$0.90	362F91-8	Plate	\$7.00
314F71-8	Screw 1/4-20 x 2-3/8" FHMS	\$2.40	364F22-8	Washer	\$6.00
321F90-7	Dogging Device Sub Assembly	\$42.40	364F27-2	Locking Slide	\$26.00
Ø 326F73-7	Set Screw	\$4.80	364F28-8	Locking Lever Sub Assembly	\$34.00
329F75	Screw Packet	\$87.90	364F30-8	Lifting Lever	\$28.00
329F76	Screw Packet	\$70.90	364F36*	Escutcheon Assembly RHR, C4, D4, E4 - std.	\$281.00
333F51-9	Screw	\$2.00	364F37*	Escutcheon Assembly LHR, C4, D4, E4 - std.	
341F31-8	Shim	\$19.50	364F38*	Escutcheon Assembly RHR, C4, D4, E4 - MR	\$293.00
349F06-8	Lifting Finger (Inactive Case)	\$25.50	364F39*	Escutcheon Assembly LHR, C4, D4, E4 - MR	
351F50*	<b>Active Case - less cover, ED7400 standard</b>	\$165.10	365F00-3	Slide Extension S/A Door 1-3/4"	\$43.00
	606, 612, 619, 622, 626				
	605, 611, 613, 625, 629, 630				
351F51*	<b>Active Case - less cover, ED74000, ED7401, no bottom rod</b>	\$165.10	365F01-3	Slide Extension S/A Door 2-1/4"	\$6.00
	606, 612, 619, 622, 626				
	605, 611, 613, 625, 629, 630				
351F52-8	10-32 x 7/16" FHUMS-PH Screw †Order 100-	\$0.50	365F03-3	Slide Extension S/A Door 1-3/4" or Lever Trim	\$21.00
351F55-3	Slide Sub Assembly	\$151.10	365F98*	1/4-20 x 2" OHTS-F-PH Metal Door	
351F56*	Active Case Sub Ass'y, ED7400 with dogging -RHR	\$836.00	370F55-8	Spindle 1-3/4" door	\$21.00
351F57*	Active Case Sub Ass'y, ED7400 with dogging -LHR		370F56-8	Spindle 2" door	
351F50*	<b>Active Case - less cover, ED7400 standard</b>	\$165.10	370F63-8	Spindle Sub Assembly	\$7.20
			376F42	<b>Latch Sub Assembly</b>	\$50.00
			611, 612, 613, 619, 625, 626		
378F74-5	Tenon Sub Assembly	\$41.00	376F42	605, 606, 629, 630	\$60.00
			605, 611, 613, 625, 629, 630		
379F25	<b>Lever Sub Assembly RH</b>	\$143.00	379F25	605, 606, 619, 625, 626	\$251.00
	611, 612, 613				
	<b>Lever Sub Assembly LH</b>			\$143.00	
379F26	605, 606, 619, 625, 626	\$251.00			
382F63-6	611, 612, 613				
382F63-6	Backplate Sub Assembly Active	\$139.00	382F68-6	Slide	\$47.00

\*Specify Finish. Ø Subject to availability.

† Sold only in multiples of the number indicated. Price is each.

**DEVICE PARTS (Cont'd)**

PART NO.	DESCRIPTION	LIST PRICE	PART NO.	DESCRIPTION	LIST PRICE
382F69-8	Compensator	\$19.00	398F69-8	Rose Liner	\$3.50
382F72-9	Flanged Nyliner	\$5.10	<b>Case Cover</b>		
382F78/8	Cam	\$23.00	398F89	605, 606, 611, 612, 613, 619, 625, 626, 629, 630	\$85.00
382F79-8	Clip †Order 50-	\$0.60	398F91-9	Bumper	\$5.10
382F80-8	Bushing	\$3.70	398F94-8	Connecting Pin	\$3.90
382F81-8	Cam Driver	\$6.00	398F95-7	Trip	\$5.10
382F82-8	Cam Driver	\$6.00	398F99-7	Top Pusher Assembly	\$97.00
382F85-8	Pivot	\$3.40	399F00*	Case Cover	\$71.00
382F86-5	Half Case	\$19.00	399F02-7	Bridge	\$46.00
382F87-8	Lever Assembly	\$23.00	399F05-7	Case	\$70.00
382F88-8	Lever Assembly	\$25.00	399F06-7	Top Latch Sub Assembly	\$212.00
382F95-6	Backplate Assembly	\$336.00	399F07-7	Bottom Bolt	\$85.00
382F98-6	Backplate Assembly (Active)	\$289.00	399F10-8	Frame and Bridge Assembly	\$99.00
386F15-8	Cover Screw 8-31 x 1/2" FHMS-PH	\$0.60	399F12*	Top Pusher Assembly	\$397.00
389F54*	Grip	\$117.00	399F13*	Bottom Bolt Assembly	\$367.00
389F62	Grip	\$113.00	399F18-8	Lower Bolt Assembly	\$335.00
391F88-2*	Top Latch Assembly	\$99.00	399F21*	Grip	\$97.00
Ø 391F90-9	Pad †Order 20-	\$1.84	399F22*	Grip	
391F94-8	Frame	\$27.00	399F23*	Escutcheon	\$214.00
391F96-8*	Frame & Yoke Assembly	\$97.00	399F25*	Escutcheon	\$107.00
391F99*	Bushing Retainer Assembly	\$19.00	Ø 399F58-8	Washer	\$4.50
392F02	<b>Top Latch S/A</b>		<b>Bottom Rod</b>		
	605, 606, 611, 612, 613, 619, 625, 626, 629, 630	\$291.00	399L11 x 563	605, 606, 611, 612, 613, 619, 625, 626, 629, 630	\$222.00
392F05*	Latchbolt Assembly	\$96.00	402F99*	Thumbpiece	\$44.00
392F08-8	Bottom Slide Assembly	\$26.00	403F03-5	Slide x4M Trim	\$87.00
392F10	Bottom Latch Assembly	\$228.00	403F30*	Washer	\$3.00
392F11	<b>Bottom Latch S/A</b>		405F42-8	Anchor	\$6.00
	605, 606, 611, 612, 613, 619, 625, 626, 629, 630	\$326.00	405F45-8	Mullion (507) 7'2" door	\$228.00
392F14-8	Adjusting Bolt	\$24.00	Ø 405F46-6	Bottom Plate	\$103.00
392F23*	Adjusting Top Strike	\$92.00	405F47-6	Top Plate	\$91.00
392F23-7*	Adjusting Top Strike, stainless	\$126.00	405F49-6	Bottom Plate Assembly	
392F27-9	Rod Guide Sub Assembly	\$6.00	Ø 409F83-6	Top Plate Assembly	
392L19*	Adj. Bottom Rod Assembly	\$228.00	410F13*	Escutcheon	
			410F14*	Escutcheon x cyl.	
392L20 x 547	<b>Adjusting Bottom Rod S/A Flush Strike</b>		410F20*	Escutcheon	
	605, 606, 611, 612, 613, 619, 625, 626, 629, 630	\$252.00	411F96-4	Spring	\$11.00
392L20 x 568	<b>Adjusting Bottom Rod S/A</b>		411F98-7	Plunger Spring †Order 100-	\$3.00
	Regular Strikes 605, 606, 611, 612, 613, 619, 625, 626, 629, 630	\$252.00	412F03-7	Retractor Spring †Order 20-	\$2.00
393L13-M672*	Top Rod	\$168.00	412F06-7	Latch Bushing	\$7.00
393L14 x 672	<b>Top Rod S/A (Standard)</b>		412F07-8	Latch Pivot Screw	\$3.00
	605, 606, 611, 612, 613, 619, 625, 626, 629, 630	\$252.00	412F08-7	Latch Spring	\$3.00
397F91-8	Backplate Sub Assembly	\$110.00	412F09-1	Spacer	\$4.00
			412F11-7	Spring	\$3.00
			412F13-3*	Screw, 8-32 x 5/16"	

\*Specify Finish. Ø Subject to availability.

† Sold only in multiples of the number indicated. Price is each.



**DEVICE PARTS (Cont'd)**

PART NO.	DESCRIPTION	LIST PRICE	PART NO.	DESCRIPTION	LIST PRICE
412F15-7	Lever Pivot	\$11.00	<b>BLANK FRONTS AND STRIKES FOR STOCK HOLLOW METAL DOORS AND FRAMES Steel, USP</b>		
412F16-7	Deadlocking Plunger	\$20.00			
412F45-1	Inactive Backplate Assembly	\$100.00	077F19-8	Front, 2-1/4" x 1-1/8"	\$8.00
416F81-8	Stud	\$8.00	334F99	Front, 8" x 1-1/4"	\$20.00
418F28-8	Dogging Screw	\$6.00	Ø 236L718018	Strike, 4-7/8" x 1-1/4"	\$8.00
418F30-8	Rivet	\$3.00	321F24*	RHR Bracket for P3 trim	\$103.00
418F35-2	Hub	\$47.00	393L13-M672*	Top Rod	\$168.00
418F36-8	Lever, RH	\$5.00	Ø 399F16-8	Spindle Adapter	\$48.00
418F37-8	Lever, LH		399F17-8	Lower Rod Assembly	\$168.00
420F12-8*	Screw Packet	\$43.00	402F98-3	Extension Slide	\$33.00
433F97-8	Lever Pivot	\$41.00	402F99*	Thumbpiece	\$44.00
433F98-8	Lever Pivot		408F25-8	Guide Spring	\$1.00
434F00-8	Lever Pivot	\$24.00	503F53-3	Bottom Strike	\$57.00
434F02-8	Screw 1/4-20 x 3/4" BUHC-SK	\$1.00	503F55-7	Top Strike	\$53.00
464F02-8	Mullion (508) 8' door	\$222.00	503F56-7	Top Strike - Fire Rated	
464F91-5	Active Case Casting only	\$43.00			
467F94-2	Thumbpiece Lever RH	\$78.00			
467F95-2*	Thumbpiece Lever LH				
468F02-2*	Lever, inactive RH	\$118.00			
468F03-2*	Lever, inactive LH				
468F12-2	Thumbpiece Lever Assembly RH	\$203.00			
468F13-2	Thumbpiece Lever Assembly LH				
468F14-7	Latch Pin Assembly RH	\$78.00			
468F15-7	Latch Pin Assembly LH				
468F16-2	Lever Assembly RH	\$74.00			
468F17-2	Lever Assembly LH				
468F20-2*	Lever Assembly RH	\$187.00			
468F21-2*	Lever Assembly LH				
468F24-6	Active Backplate Assembly, RH	\$770.00			
468F25-6	Active Backplate Assembly, LH				
468F26-6	Active Backplate Assembly, RH				
468F27-6	Active Backplate Assembly, LH				
468F35-5	Cylinder housing	\$9.00			
480F12-8	Inactive Backplate Assembly	\$103.00			
480F13*	Lever	\$260.00			
480F18-8	Spindle	\$42.00			
480F19-8	Nut	\$9.00			
480F20-8	Rollback	\$9.50			
480F28*	Lever & Spindle Assembly	\$241.00			
480F30*	Lever & Spindle Assembly	\$241.00			
480F33*	Lever & Spindle Assembly	\$245.00			
480F37-5	Slide	\$48.00			
482F44-2	*Bushing	\$52.00			
482F49*	Escutcheon	\$239.00			
482F73*	Escutcheon & Bushing	\$245.00			
484F41-8	Rollback	\$16.00			
484F89-8	Knob Shank Sub Assembly	\$31.00			
492F19-5	Slide	\$85.00			
499F60-8*	Tenon Packet	\$56.00			
622F68	Screw Pack for 2"-2-1/4" door 613, 626	\$52.00			
<b>BLANK PLATE FOR STOCK HOLLOW METAL DOORS</b>					
561F29	<b>Bank Plate 14" x 3-1/2"</b> Used on the outside of stock cut-out hollow metal doors where no trim is desired				
	605, 606, 612, 613, 619, 625, 626, 630	\$127.00			

\*Specify Finish.      Ø Subject to availability.

PART NO.	DESCRIPTION	LIST PRICE	PART NO.	DESCRIPTION	LIST PRICE
<b>ALARM DELAY SWITCH</b>			<b>MISCELLANEOUS</b>		
696F318	for M62 option	\$51.00	650F27-9	Dogging Hole Plug	\$0.70
<b>BAR 689, 690, 691</b>			697F98-8	Sex Nut Pack (M54)	\$16.30
436F41-8	for ED8400, 30" door width, with dogging	\$325.70	436F858	Latch Assembly Screw	\$0.60
436F42-8	for ED8400, 36" door width, with dogging		558F52-8	Mounting packet for F1 and P8 Trim 689, 690, 691	\$21.70
436F43-8	for ED8400, 42" door width, with dogging		482F79-8	ANSI fastening plate packet for G3 Trim No Finish	\$8.90
436F44-8	for ED8400, 48" door width, with dogging	\$349.70	123F53-8	Dogging Key, 3/16" hex No Finish	\$3.30
387F21-8	for ED8200, 30" door width, with dogging	\$305.70	<b>MOUNTING PACKET 605, 606, 611, 612, 613, 619, 622, 625, 626</b>		
387F24-8	for ED8200, 36" door width, with dogging		469F67	for F157, P857 trim	\$25.00
387F27-8	for ED8200, 42" door width, with dogging		469F68	for F150, P150, P850 trim (dummy)	\$14.10
387F30-8	for ED8200, 48" door width, with dogging	\$327.70	496F68	for P257 trim	\$27.00
387F63-8	for ED8200, 30" door width, less dogging	\$299.70	496F69	for P250 trim (dummy)	\$25.00
387F66-8	for ED8200, 36" door width, less dogging		<b>PLATES AND PULLS 689, 690, 691</b>		
387F69-8	for ED8200, 42" door width, less dogging		436F82-8	for F1 Trim, plate - no cylinder hole	\$38.00
387F72-8	for ED8200, 48" door width, less dogging	436F83-8	for F1 Trim, plate - with cylinder hole		
564F888	for ED8400, 30" door width, less dogging	\$319.70	436F80-1	for P8 Trim, pull - no cylinder hole	\$44.00
564F898	for ED8400, 36" door width, less dogging		436F81-1	for P8 Trim, pull - with cylinder hole	
564F908	for ED8400, 42" door width, less dogging		602F15-1	Pull Grip (Black) for P2 622 Only	\$51.00
564F918	for ED8400, 48" door width, less dogging	\$343.70	<b>605, 606, 611, 612, 613, 619, 622, 625, 626</b>		
564F378	for ED8400A, 30" door width, less dogging	\$319.70	270F13	Escutcheon for P3 trim without cylinder hole	\$101.00
564F408	for ED8400A, 36" door width, less dogging		492F20	Offset Pull for P1 trim without cylinder hole	\$124.90
564F438	for ED8400A, 42" door width, less dogging		492F21	Offset Pull for P1 trim with cylinder hole	\$143.90
564F688	for ED8400A, 48" door width, less dogging	\$343.70	602F18-1	Pull Base for P2 trim plate without cylinder hole	\$184.90
<b>BOTTOM ROD</b>			602F17-1	Pull Base for P2 trim plate with cylinder hole	\$202.90
436L32-8557	for ED8400, 40-5/16" Pushbar Height, for Door 7"6" high	\$171.50	328F80	Pull Tube for P3 trim	\$102.90
526L51-8540	for ED8400A		<b>REAR COVER 689, 690, 691</b>		
<b>BRACKET 605, 606, 611, 612, 613, 619, 622, 625, 626</b>			603F64	for ED8000 devices purchased AFTER Nov. 1, 1993	\$26.00
321F23	LHR Bracket for P3 trim	\$119.40	<b>ROD GUIDE PACKET SCREW PACKET</b>		
321F24	RHR Bracket for P3 trim		446F20-8	Rod guide packet	\$33.60
<b>FRAME PLATES</b>			523F03-8	for ED8200(B) and ED8400(A), Packet for mounting bar & active case with SNB	\$33.60
552F59-8	for ED8400 - RHR	\$155.30	484F20-8	for ED8400, Packet for mounting top latch	\$54.30
552F60-8	for ED8400 - LHR		484F21-8	for ED8400, Packet for mounting bottom latch	\$22.80
552F468	for ED8400A - RHR	\$224.70	261F30-8	for ED8200, Latch & Frame Plate Attachment Screw †Order 20-	\$2.50
552F478	for ED8400A - LHR		<b>ROD GUIDE PACKET SCREW PACKET (Cont'd)</b>		
<b>FRONT COVER</b>			449F82-8	for ED8200(B) and ED8400 for bar & active case	\$22.80
564F345	for ED8400 (A) (not handed)	\$45.20	492F59	Rear Side Screw Packet for P1 trim	\$4.80
385F54-5	for ED8200(B) (not handed)	\$53.20	564F128	for ED8200A, Packet for mtg. bar & active case with SNB	\$40.20
564F115	for ED8200A (not handed)	\$65.20	534F008	for ED8400A, Packet for mtg. Top & bottom latch	\$48.20
<b>KNOB 605, 606, 611, 612, 613, 619, 625, 626</b>			<b>SHIM KITS</b>		
695F22	for G10 Trim, plain	\$109.60	557F92-8	for ED8200 (B)	\$80.30
695F23	for G10 Trim, with cylinder hole	\$107.60	557F93-8	for ED8200A	\$80.30
<b>LATCH</b>			557F94-8	for ED8400	\$133.50
436F25-8	for ED8400, Top No Finish	\$179.20	557F95-8	for ED8400A	\$133.50
436F29-8	for ED8400, Bottom No Finish	\$95.50			
552F36-8	for ED8200(B) 626	\$111.50			
552F41-6	for ED8200A	\$262.80			
525F99-8	for ED8400A, top	\$191.10			
526F16-8	for ED8400A, bottom	\$220.40			
<b>LATCH COVER 689, 690, 691</b>					
526F32-1	for ED8400A, Top or Bottom Latches	\$85.80			
446F23-1	for ED8400, Top or Bottom Latches	\$73.80			

†Sold only in multiples of the number indicated. Price is each.

**DEVICE PARTS (Cont'd)**

PART NO.	DESCRIPTION	LIST PRICE	PART NO.	DESCRIPTION	LIST PRICE
<b>STRIKE PACKET</b>			<b>LEVERS ALL FINISHES</b>		
391F57-5	for ED8200, Shim used with 1/2" Stop	\$27.20	<b>LFIC, 1-3/8" TO 2-1/4" DOORS</b>		
446F21M	for ED8400, Packet for Top Latch.Strike 605, 606, 611, 612, 613, 622, 625, 626	\$43.20	585F715	N6 x cylinder (LFIC core 6-pin)	\$101.00
446F22-8	for ED8400, Packet for Bottom Latch (Surface Mounting) 625 only	\$33.20	600F415	N6 x cylinder (LFIC core 7-pin)	
463F92-8	for ED8400, Packet for Bottom Latch (Flush Mounting) 625 only	\$29.20	596F825	N6 x Best® cylinder cutout	\$103.00
386F45-3	for ED8200(B) Strike Packet 612, 613, 626	\$39.20	585F705	A6 x cylinder (LFIC core 6-pin)	\$101.00
468F30-5	Packet for Rim by Vertical Rod 605, 606, 612, 613, 622, 625, 626, 689, 690, 691	\$33.20	600F425	A6 x cylinder (LFIC core 7-pin)	
518F06-7	for ED8200A	\$66.20	685F535	P6 x cylinder (LFIC core 6-pin)	
526F52-7	for ED8400A, Packet for Top Strike	\$44.20	685F545	P6 x cylinder (LFIC core 7-pin)	
526F53-3	for ED8400A, Packet for Bottom Strike	\$40.20	685F555	P6 x Best cylinder cutout	\$103.00
<b>TOP ROD</b>					
487L048-697	for ED8400, 40-5/16" Pushbar Height, for Door 7'6" high	\$95.50			
487M048-589	for ED8400, 40-5/16" Pushbar Height, for Door 7'6" high to 10' high	\$123.50			
526L928759	for ED8400A	\$81.50			
<b>CHASSIS, 1-3/4" TO 2-1/4" DOORS NO FINISH</b>					
690F44	Dummy (50)	\$91.20			
698F43	Passage (10)				
698F44	Classroom (55)	\$99.20			
698F45	Nightlatch (57)				
698F46	Storeroom (59)				
698F51	Classroom - LFIC	\$105.20			
698F52	Nightlatch - LFIC				
698F53	Storeroom - LFIC				
<b>MISCELLANEOUS 605, 606, 611, 612, 613, 619, 625, 626</b>					
678F25	Rose for X6 trim	\$26.00			
585F72	Lever Insert for X6 trim	\$2.00			
682F91	Recore Driver Packet	\$5.60			
696F05	Mounting Packet	\$4.00			
<b>LEVERS ALL FINISHES</b>					
<b>STANDARD 1-3/8" TO 2-1/4" DOORS</b>					
563F955	N6 design x cylinder or button	\$99.00			
563F965	N6 design x emergency key hole				
563F945	N6 design x plain				
578F435	N6 x Sargent® cylinder cutout	\$101.00			
563F895	A6 design x cylinder or button	\$99.00			
563F905	A6 design x emergency key hole				
563F885	A6 design x plain				
685F515	P6 design x cylinder or button				
685F525	P6 design x emergency key hole				
685F505	P6 design x plain				

†Sold only in multiples of the number indicated. Price is each.

## ASSA ABLOY

### DC3000 CLOSER PARTS

PART NO.	DESCRIPTION	LIST PRICE
<b>TOOLS</b>		
330F10	Hex wrench for closer valve, 3/32"	\$3.10
597F24	Torx tool kit	\$168.30
<b>CLOSER BODIES 600, 689, 690, 691, 693, 696</b>		
540F27	Closer body for DC3200	\$307.00
597F35	Closer body for DC3200 x M71	\$345.00
<b>M71 = Delayed action</b>		
<b>ARMS 600, 689, 690, 691, 693, 696</b>		
688F95	Regular arm	\$108.00
688F77	Regular arm with hold-open	\$158.00
688F95	Top jamb	\$108.00
688F77	Top jamb with hold-open	\$158.00
689F02	Heavy-duty parallel arm	\$160.00
689F01	Heavy-duty parallel arm with hold-open	\$180.00
597F52	Heavy-duty regular arm	\$160.00
689F03	Heavy-duty parallel arm with backstop	\$168.00
689F04	Heavy-duty parallel arm with backstop & hold-open	\$155.30
691F98	Reg. secondary arm assy.	\$36.90
691F99	Deep reveal secondary arm assembly	\$38.00
692F02	Reg. H.D. secondary arm assembly	\$142.20
692F03	Deep reveal H.D. secondary arm assembly	\$244.30
<b>BRACKETS 600, 689, 690, 691, 693, 696</b>		
188F03	Quik-Install™	\$16.30
188F41	Parallel arm	\$5.20
509F49	Parallel arm with hold-open	\$35.80
188F62	Parallel arm offset	\$23.90
188F63	Parallel arm for flush transom	\$35.80
244F17	Regular arm mortise	\$43.80
447F14	Angle Support Bracket and Spacer	\$35.80
<b>DROP PLATES 600, 689, 690, 691, 693, 696</b>		
188F65	For DC3220 x full cover	\$54.30
597F58	For DC3210 x full cover	\$61.00
<b>COVERS 600, 689, 690, 691, 693, 696</b>		
597F78	Full cover and insert packet (standard)	\$34.80
<b>PAINT (PER CAN)</b>		
597F94	Silver Aluminum - 689	\$45.60
597F95	Dark Bronze - 690	
597F96	Light Bronze - 691	
597F97	Satin Brass - 696	

## DC3000/DC5000 Series Door Closers

### DC5000 CLOSER PARTS

PART NO.	DESCRIPTION	LIST PRICE
<b>CLOSER BODY 600, 689, 690, 691, 693, 696</b>		
754F68	Closer Body Only	\$391.90
<b>ARMS 600, 689, 690, 691, 693, 696</b>		
754F95	Pull Side Slide Track & Arm Assy., Non-Hold Open	\$160.60
754F96	Pull Side Slide Track & Arm Assy., Hold Open	\$243.20
795F97	Push Side Slide Track & Arm Assy., Non-Hold Open	\$160.60
754F98	Push Side Slide Track & Arm Assy., Hold Open	\$243.20
754F92	Hold Open Assembly	\$36.00
<b>COVER</b>		
754F79	Plastic Cover	\$35.80
<b>DROP PLATE</b>		
754F80	Push side, drop plate	\$42.40
<b>ANGLE BRACKET</b>		
754F93	Stop Mount Track Angle Bracket	\$76.00
<b>SCREW PACKETS</b>		
754F69	Closer Screw Pack	\$9.30
754F70	Spline Screw Pack	\$23.90
754F94	Track Screw Pack	\$11.90

**CLOSER PARTS**

PART NO.	DESCRIPTION	LIST PRICE
<b>CLOSER BODIES 600, 689, 690, 691, 693, 696</b>		
689F12	Closer body for DC6200	\$361.50
689F13	Closer body for DC6200 x M71	\$399.50
689F14	Closer body for DC6401	\$361.50
689F15	Closer body for DC6402	
689F16	Closer body for DC6403	
689F17	Closer body for DC6404	
689F18	Closer body for DC6405	
689F19	Closer body for DC6406	
691F52	Closer body for DC6401 x M71	
691F53	Closer body for DC6402 x M71	
691F54	Closer body for DC6403 x M71	
691F55	Closer body for DC6404 x M71	
691F56	Closer body for DC6405 x M71	
691F57	Closer body for DC6406 x M71	
M71 = Delayed action		
<b>ARMS 600, 689, 690, 691, 693, 696</b>		
688F95	Regular arm, consists of:	\$108.00
	688F99 main arm & tube assembly	\$68.00
	688F98 rod & shoe assembly	\$29.00
	688F92 hex screw pkg.	\$11.00
688F77	Regular arm with hold-open (A1), consists of:	\$158.00
	691F92 main arm & rod assy	\$63.00
	540F40 hold-open bracket assembly	\$95.00
689F02	Heavy duty parallel arm (A3)	\$160.00
689F01	Heavy duty parallel arm with hold-open (A2)	\$180.00
597F52	Heavy duty regular arm (A10)	\$160.00
689F03	Heavy duty parallel arm with backstop (A4)	\$168.00
689F04	Heavy duty parallel arm with backstop & hold-open (A5)	\$155.30
615F52	HD Spring stop for Dr. wdth. 28"-32" (A11)	\$159.60
615F54	Unitrol® for Dr. wdth. 33"-41"	
615F56	Unitrol® for Dr. wdth. 42"-48"	
615F51	Unitrol®/HO for Dr. wdth. 28"-32" (A12)	
615F53	Unitrol®/HO for Dr. wdth. 33"-41"	
615F55	Unitrol®/HO for Dr. wdth. 42"-48"	\$179.60
691F96	Heavy-duty offset arm (A13)	\$106.30
754F16	DC6230, DC6430 pull side - arm only	\$82.00
754F10	DC6230, DC6430 - track only (hold-open)	\$243.20
754F09	DC6230, DC6430 - track only (non hold-open)	\$160.60
754F44	DC6230, DC6430 pull side track assembly, non-hold open	\$345.20
754F45	DC6230, DC6430 pull side track assembly, hold open	\$431.00
754F12	DC6240, DC6440 push side track & arm (non hold open)	\$240.00
754F14	DC6240, DC6440 - track only (non hold-open)	\$160.60
754F13	DC6240, DC6440 track & arm (hold-open)	\$326.00
754F15	DC6240, DC6440 - track only (hold-open)	\$243.20
754F16	DC6240, DC6440 - arm only (hold-open)	\$82.00
691F72	Deep reveal arm (7-1/4" max), consists of:	\$97.00
	688F99 main arm and arm tube assy	\$68.00
	691F75 rod & shoe assembly	\$11.90

PART NO.	DESCRIPTION	LIST PRICE
<b>ARMS 600, 689, 690, 691, 693, 696</b>		
691F74	Deep reveal arm w/hold-open (7-1/4" max), consists of:	\$129.80
	691F95 main arm & rod assy- deep reveal	\$129.80
	540F40 hold-open bracket assy.	\$28.20
		\$95.00
615F58	Reinforcing bracket	\$30.40
615F59	Deep reveal reinforcing kit	\$40.90
615F60	Flush partition bracket	\$29.40
692F04	Friction, Hold Open Arm RH	\$97.70
692F05	Friction, Hold Open Arm LH	\$97.70
692F00	Reg. Secondary Arm Assy.	\$36.90
692F01	Top Jamb Secondary Arm Assy.	\$38.00
692F02	Reg. H.D. Secondary Arm Assy.	\$142.20
692F03	Deep Reveal HD. Secondary Arm Assy.	\$244.30
<b>BRACKETS 600, 689, 690, 691, 693, 696</b>		
188F03	Quik-Install™	\$16.30
188F41	Parallel arm	\$5.20
509F49	Parallel arm with hold-open	\$35.80
188F63	Parallel arm for flush transom	\$35.80
188F62	Parallel arm offset	\$23.90
244F17	Regular arm mortise	\$43.80
447F14	Angle support	\$35.80
499F30	Flush transom	\$22.80
691F78	Spacer	\$3.90
<b>COVERS 600, 689, 690, 691, 693, 696</b>		
597F78	Full cover and insert pkt. (standard)	\$34.80
603F55	Full metal cover RH/LHR	\$40.20
603F57	Full metal cover LH/RHR	
261F95	Cover screw pack	\$3.50
<b>DROP PLATES 600, 689, 690, 691, 693, 696</b>		
188F65	For DC6220 x full cover	\$52.00
	For DC6420 x full cover	
597F58	For DC6210, DC6410, DC6240, DC6440 x full cover	\$61.00
597F59	For DC6230, DC6240, x full cover	\$52.00
	For DC6430, DC6440 x full cover	
<b>BLADE STOP SPACER</b>		
597F92	1/2" Spacer block	\$21.70
597F93	5/8" Spacer block	\$35.80
<b>SCREW PACKETS 600, 689, 690, 691, 693, 696</b>		
691F93	Standard Screw Pack	\$10.30
691F94	Standard Screw Pack w/ Sex Nuts	\$17.40
468F34	SNB for 1-3/4" door	\$9.60
691F89	Torx® Screw Pack	\$23.40
691F90	Torx Screw Pack with Sex Nuts	\$27.40
597F24	Torx® tool kit	\$168.30
754F43	Screw pack (push or pull track)	\$15.20
<b>PAINT (PER CAN)</b>		
597F94	Silver Aluminum - 689	\$45.60
597F95	Dark Bronze - 690	
597F96	Light Bronze - 691	
597F97	Satin Brass - 696	

## CLOSER PARTS

PART NO.	DESCRIPTION	LIST PRICE
<b>CLOSER BODIES</b>		
754F21	Closer body for DC8200	\$401.00
754F26	Closer body for DC8200 x M71	\$439.00
<b>ARMS</b>		
688F95	Regular arm, consists of:	\$108.00
	688F99 main arm & tube assembly	\$68.00
	688F98 rod & shoe assembly	\$29.00
	688F92 hex screw pkg.	\$11.00
688F77	Regular arm with hold-open (A1), consists of:	\$158.00
	691F92 main arm & rod assy	\$63.00
	540F40 hold open bracket assembly	\$95.00
689F02	Heavy-duty parallel arm (A3)	\$160.00
689F01	Heavy-duty parallel arm with hold-open (A2)	\$180.00
597F52	Heavy-duty regular arm (A10)	\$160.00
689F03	Heavy-duty parallel arm with backstop (A4)	\$168.00
689F04	Heavy-duty parallel arm with backstop & hold-open (A5)	\$155.30
615F52	Unitrol® - Dr. width 28"-32" (A11)	\$159.60
615F54	Unitrol® - Dr. width 33"-41" (A11)	
615F56	Unitrol® - Dr. width 42"-48" (A11)	
615F51	Unitrol® w/ Hold Open - Dr. width 28"-32" (A12)	\$179.60
615F53	Unitrol® w/ Hold Open - Dr. width 33"-41" (A12)	
615F55	Unitrol® w/ Hold Open - Dr. width 42"-48" (A12)	
691F96	Heavy-duty offset arm (A13)	\$106.30
692F04	Heavy duty friction hold open, RH (A14)	\$97.70
692F05	Heavy duty friction hold open, LH (A14)	\$97.70
754F09	Pull side track only, non-hold open	\$160.60
754F10	Pull side track only, hold open	\$243.20
754F12	Push side track & arm, non-hold open	\$240.00
754F13	Push side track & arm, hold open	\$326.00
754F14	Push side track only, non-hold open	\$160.60
754F15	Push side track only, hold open	\$243.20
754F16	Slide track assembly (non-hold open or hold open)	\$82.00
691F72	Deep reveal arm (7 1/4" max) consists of:	\$97.00
	688F99 main arm and arm tube assy	\$68.00
	691F75 rod & shoe assembly	\$11.90
691F74	Deep reveal arm with hold-open (7 1/4" max), consists of:	\$129.80
	691F95 main arm & rod assy- deep reveal	\$28.20
	540F40 hold open bracket assy.	\$95.00
615F58	Reinforcing bracket	\$30.40
615F59	Deep reveal reinforcing kit	\$40.90
615F60	Flush partition bracket	\$29.40

PART NO.	DESCRIPTION	LIST PRICE
<b>BRACKET</b>		
754F18	Quik-Install™	\$17.40
188F41	Parallel arm	\$5.20
509F49	Parallel arm with hold-open	\$35.80
188F63	Parallel arm for flush transom	\$35.80
188F62	Parallel arm offset	\$23.90
244F17	Regular arm mortise	\$43.80
447F14	Angle support	\$35.80
499F30	Heavy duty parallel arm flush transom bracket	\$22.80
<b>COVERS</b>		
754F84	Full ABS cover	\$30.00
754F22	Full metal cover RH/LHR	\$54.30
754F23	Full metal cover LH/RHR	
754F17	Cover screw pack	\$4.10
<b>DROP PLATES</b>		
754F20	For DC8200 (regular)	\$76.00
754F24	For DC8200 (with concealed holder)	\$76.00
	For DC8220 (top jamb)	
754F25	For DC8210 (parallel)	\$76.00
	For DC8230 (pull side track)	
	For DC8240 (push side track)	
<b>BLADE STOP SPACER</b>		
597F92	1/2" Spacer block	\$21.70
597F93	5/8" Spacer block	\$35.80
<b>SCREW PACKETS</b>		
754F37	Standard screw pack	\$10.90
754F29	Standard screw pack (includes sex nuts)	
754F30	SNB for 1-3/4" door	\$14.10
754F38	Torx® screw pack	\$34.80
754F34	Torx screw pack (includes sex nuts)	
597F24	Torx® tool kit	\$4.70
754F35	Main arm screw & washer	
<b>RETROFIT PLATES</b>		
754F36	To Replace DC6000 (Reg. Arm)	\$80.30
754F46	To Replace DC6000 (Par. Arm or Top Jamb)	\$80.30

PART NO.	DESCRIPTION	LIST PRICE	PART NO.	DESCRIPTION	LIST PRICE
<b>DC62900 SERIES ELECTROMECHANICAL CLOSERS</b>			<b>DC46920 SERIES ELECTROMECHANICAL DOOR HOLDER AND CLOSER</b>		
689F12	DC6000 Closer Body	\$361.50	494F77	Arm Assembly "Pull side"	\$166.10
188F03	Quik-Install Bracket	\$16.30	494F76	Arm Assembly "Push side"	
597F78	Full Cover	\$34.80	494F74	Holder - 120VAC	\$352.90
603F55	Full Metal Cover RH	\$40.20	494F75	Holder - 24VAC/DC	\$352.90
603F57	Full Metal Cover LH	\$40.20	494F72	Holder cover - Non Detector	\$134.60
692F24	Standard Arm Assembly	\$79.30	494F86	System plug - 120VAC/24VAC	\$81.50
692F25	Adjusting Head and Tube Assembly	\$98.80	494F92	System plug - 24VDC	
692F14	Slide Assembly	\$84.60	494F93	Wire harness - 120VAC/24VAC	\$66.50
692F15	Arm Stud Clip	\$7.50	494F94	Wire harness - 24VDC	
692F16	Track Assembly End Cap	\$6.20			
692F17	Solenoid Block Assembly, 24V	\$253.00			
692F19	Adjusting Rod Assembly	\$41.20			
692F20	Arm Stud	\$5.00			
692F21	Retaining Ring	\$2.40			
692F23	Arm Length Adjusting Screw	\$1.60			
754F02	Double Egress Arm, RH	\$144.40			
754F03	Double Egress Arm, LH	\$144.40			
754F04	Adjusting Head and Tube Assembly, RH	\$96.70			
754F05	Adjusting Head and Tube Assembly, LH	\$96.70			
754F52	Track Assy. (Hinge Side) Master or support units	\$314.80			
754F53	Track Assy. (Stop Side) Master or support units				
754F54	Hook-Up Board, Master or Support, 24V	\$103.20			
754F55	Hook-Up Board, Master or Support, 120V	\$154.20			
754F56	Hook-Up Box, Master unit, 24V, push side	\$273.60			
754F57	Hook-Up Box, Master unit, 120V, push side				
754F58	Hook-Up Box, Support unit, 24V, push side	\$262.80			
754F59	Hook-Up Box, Support unit, 120V, push side				
754F61	Hook-Up Box, Master unit, 24V, pull side	\$273.60			
754F62	Hook-Up Box, Master unit, 120V, pull side				
754F63	Hook-Up Box, Support unit, 24V, pull side	\$273.60			
754F64	Hook-Up Box, Support unit, 120V, pull side				
754F66	Fuse	\$15.20			
754F71	Hook-Up Box Cover Kit (included cover & screws), Master	\$273.60			
754F72	Hook-Up Box Cover Kit (included cover & screws), Support	\$46.70			
754F73	Smoke Detector Board	\$407.20			

PART NO.	DESCRIPTION	LIST PRICE
<b>Access 800° ACZ Series</b>		
794F509	Gaskets Exit device - Reader	\$10.00
794F519	Gaskets Exit device trim	\$10.00
794F529	Gaskets Cylindrical lock	\$13.00
794F539	Gaskets Mortise lock	\$13.00

Part Number	Page	Part Number	Page	Part Number	Page	Part Number	Page	Part Number	Page
019F11-7	366	120F768	362	144F29-8	366	183F75	373	213F11-7	374
019F13-7	365	120F76-8	342	144F30-8	366	183F85-7	372	217F42-2	337
021F68-8	338	120F76-8	360	144F33	365	184F57	373	217F43	338
021F71-8	338	120F76-8	364	144F34	365	184F82-5	373	217F43	339
022F72-3	366	120F76-8	364	144F88-8	366	184F94-8	373	217F43-2	337
022F80	365	120F768	366	145F32-8	366	184F97*	373	217F44	338
025F72-2	338	121F01-2	338	145F54-3*	373	185F55-8	373	217F44	339
025F858	360	121K10	336	146K80	336	186F23	373	217F44-2	337
025F858	362	121K11	336	147F07-8	365	186K75	336	217L13	354
026F75-7	337	122F18-8	373	147F77-2	338	187F21-3	373	217L13	360
041F47-8	338	122F24-8	373	147F77-8	338	187F88-7	373	217L13	362
060F05-3	366	122F41-3	373	147F83-8	373	187F89-7	373	217L13	364
060F33-8	365	122F50-8	373	147F84-9	373	188F03	380	217L13M016	358
060F42-8	365	122F51-8	373	147F87-8	373	188F03	380	217L13M016	360
065F36-2	338	122F56-8	373	147F88-8	373	188F03	381	217L13M016	363
067F42-8	365	122F57-8	373	148F15-7	373	188F03	383	217L13M016	364
070F42-8	365	122F59-3	373	148F17	373	188F41	380	217L13M016 Fin*	358
070F43-8	365	122F60-8	373	148F22-8	373	188F41	380	217L13M018	358
071F62-8	365	122F61-8	373	148F36-7	373	188F41	381	217L13M018	360
071F63-8	365	122F63-9	373	148F44-8	373	188F41	382	217L13M018	363
071F67-3	366	122F64-3*	373	154F96-6	373	188F62	380	217L13M018	364
077F19-8	377	123F22	372	156F43	365	188F62	380	217L13M018 Fin*	358
078F07-8	365	123F53-8	373	156F64-8	366	188F62	381	217L13M020	358
078F08-8	365	123F53-8	378	156F65-8	366	188F62	382	217L13M020	360
079F00	341	129F49-9	373	156F83-7	365	188F63	380	217L13M020	363
079F02	341	129F84-8	338	157F11	365	188F63	380	217L13M020	364
081F77-8	365	129F84-8	373	158F06-2	338	188F63	381	217L13M020 Fin*	358
082L67	366	131F27-8	365	158F52-8	373	188F63	382	217L13M022	358
083L96M032	366	134F05	339	158F53-8	373	188F65	381	217L13M022	360
083L96M034	366	134F05	373	158F54-8	373	188F73-8	366	217L13M022	363
083L96M036	366	135F10-8	338	158F55-8	373	188F75-8	366	217L13M022	364
083L96M040	366	135F19-2	338	159F36-7	337	193K09	336	217L13M022 Fin*	358
083L96M048	366	138F88-8	365	164F32-9	373	193K10	336	217L13M024	358
092F78-9	366	140F52-8	373	166F34-7	373	193K11	336	217L13M024	360
095F35-1	373	140F97-8	365	168F81-8	366	194F22-8	365	217L13M024	363
102F19-8	366	141F41-8	373	171F46-8	337	195K68	336	217L13M024	364
102F27-8	366	141F84*	373	171F79-8	365	197F34-7	338	217L13M024 Fin*	358
102F37-8	366	141F86*	373	171F89-6	373	197F35-7	338	217L13M028	358
103F44-8	366	141F87*	373	171F90-9	373	197F52-7	337	217L13M028	360
103F45-8	366	141L54-8	373	172F21-7	337	197K51*	336	217L13M028	363
105F70-2	338	141L59	373	173F44-6	373	198F71	365	217L13M028	364
111F55-8	338	142F16*	373	173F45-6	373	200F16-8	374	217L13M028 Fin*	358
114F67-8	366	142F43	372	173F69-8	373	201F18-8	366	217L13M032	358
118F29-9	350	142F44*	373	173F72-8	373	206F53	350	217L13M032	360
118F29-9	371	143F24-8	373	173F79-8	338	206F578	355	217L13M032	363
118F48-8	344	143F25	373	173F79-8	338	207F55-8	373	217L13M032	364
120F55-8	373	143F26-5	373	174F79-7	373	207F64*	373	217L13M032 Fin*	358
120F768	354	143F42*	373	174F80-7	373	207F68*	373	217L13M036	358
120F768	358	143F43*	373	175F51-8	373	207F69*	373	217L13M036	360
120F768	358	143F52*	373	176F65-3	372	209F55*	373	217L13M036	363
120F768	360	143F83-3	373	183F74	373	213F10-7	373	217L13M036	364



Part Number	Page	Part Number	Page	Part Number	Page	Part Number	Page	Part Number	Page
217L13M036 Fin*	358	236L72022	342	264F69-8	347	284F67*	374	314F71-8	375
217L13M040	358	236L72024	342	264F95-8	374	284F68*	375	314F88-7	337
217L13M040	360	236L72028	342	266F34-2	338	284F69*	375	314F98-7	337
217L13M040	363	236L72032	342	267F34-8*	374	284F70*	375	314F99-7	338
217L13M040	364	236L72036	342	267F97	339	284F78	375	315F93 Fin	358
217L13M040 Fin*	358	236L72040	342	268F64-7	374	284F79	375	315F93 Fin*	358
217L13M044	358	236L72044	342	268F84-8	374	284F97-7	375	315F94 Fin	358
217L13M044	360	236L72048	342	268F87-8	374	286F50-7	365	315F94 Fin*	358
217L13M044	363	236L75M020	366	269F04-8	374	286F91	375	318F64	343
217L13M044	364	240L08018	366	269F05-8	374	286F92	375	318F65	343
217L13M044 Fin*	358	240L08020	366	269F08	374	287F60-8	366	318F66	343
217L13M048	358	240L08022	366	269F09-8	374	287F96-8	375	318F67	343
217L13M048	360	240L50	372	269F31	374	291F49-8	375	318F68	343
217L13M048	363	240L51	372	269F32	374	291F57-8	375	318F69	343
217L13M048	364	242F48-2	366	269F33	374	292F41-3*	375	320F44-2	338
217L13M048 Fin*	358	242F50-8	366	269F34	374	292K95	336	320F44-2	366
219F80-8	366	243F76-9	374	269F35	374	292K96	336	321F23	378
219F88-8	338	243F79-8	374	269F36	374	292K97	336	321F24	378
219F88-8	338	243F80-8	374	269F37-8	374	292K98	336	321F24*	377
220F49-8	374	243F85	374	269F39-3	374	292K99	336	321F90-7	375
220F718	355	244F17	380	269F40-3	374	293F18-3	375	328F80	378
220F72-2	374	244F17	380	269F41-3	374	293K00	336	329F75	375
220F75	374	244F17	381	269F42	374	293K01	336	329F76	375
220F77-8	374	244F17	382	269F46-8	374	293K02	336	330F10	380
220F82-7	374	244F64-7	366	269F47-9	374	293K03	336	333F51-9	375
220F84-8	374	245K37	336	269F48-8	374	293L14	366	333F99-8	338
220F85*	374	249F33*	374	269F49-9	374	294F05-2	338	333F99-8	338
221F94-8*	374	249F76-8	366	269F52-8	374	300F68-8	351	334F12-8	338
222F71*	374	249F77-3	366	269F53-8	374	300F71	372	334F13-8	338
222F85	366	250F08-8	338	269F54-9	374	301F56-7	365	334F23-8	338
223F29	366	250F08-8	338	269F55-9	374	303F18	351	334F23-8	338
224F00-8*	363	251F19-8	366	269F56-9	374	303F19	351	334F99	377
224F34-8	374	252F82	339	269F57-8	374	303F20	351	334F998	341
224F39-2	374	253F11-8	374	269F58-7	374	303F24-2	366	334K00	336
224F44-8	374	253F75-8	338	269F60-8	374	303F25	339	334K01	336
224F50-8	374	253K66	336	269F73	372	304F33-7	372	335F98-8	366
225F99-8	374	253K67	336	269F74	372	304F34-7	372	340F27-9	350
228F18-8	374	254F73	374	269F75	372	304F65-7	375	340L60020	343
228F34-8	366	255F41*	374	269F76	372	304F66-7	375	340L60022	343
228F49-7	374	255F53	339	269F808	355	305F07	375	340L60024	343
228F51-7	374	255F54	340	269F91*	374	305F318 Fin	355	340L60028	343
228F52-8	374	261F11-8	366	269F92*	374	305F72-8	375	340L60032	343
228F54-8	350	261F28-8	374	270F01*	374	305F73-8	375	340L60036	343
228F55-8	374	261F29-8	366	270F02*	374	306F06-8	375	340L60040	343
228F68-7	374	261F29-8	374	270F11*	374	306F07-8	375	340L60044	343
228F80-8	374	261F30-8	378	270F13	378	306F15-8	375	340L60048	343
228F81-7	374	261F31-8	374	270F15	339	306F20-8	375	340L61020	343
228F84-7	374	261F54	374	281F27-2	338	306F22-8	375	340L61022	343
236L72014	342	261F65-8	374	282F32-5	374	308F78-2	338	340L61024	343
236L72018	342	261F95	381	282F35-7	374	310F48-8	338	340L61028	343
236L72020	342	262F90-1	374	283F81	366	314F52-8	375	340L61032	343

Part Number	Page	Part Number	Page	Part Number	Page	Part Number	Page	Part Number	Page
340L61036	343	364F38*	375	387F27-8	378	399F17-8	377	407T41-4270 3L	337
340L61040	343	364F39*	375	387F30-8	378	399F18-8	376	407T41-4298 4L	337
340L61044	343	365F00-3	375	387F63-8	378	399F21*	376	407T41-4326 5L	337
340L61048	343	365F01-3	375	387F66-8	378	399F22*	376	407T41-4354 6L	337
341F31-8	375	365F03-3	375	387F69-8	378	399F23*	376	407T42-4242 2R	337
342F03-2	366	365F95-8	338	387F72-8	378	399F25*	376	407T42-4270 3R	337
342F05-2	365	365F95-8	338	389F54*	376	399L11 x 563	376	407T42-4298 4R	337
349F06-8	375	365F98*	375	389F62	376	402F29	341	407T42-4326 5R	337
351F50*	375	366F70	340	391F57-5	379	402F30	341	407T42-4354 6R	337
351F51*	375	368F91-8	338	391F65-8	340	402F31	341	408F25-8	377
351F52-8	375	368F91-8	338	391F65-8	348	402F33	341	408K45	336
351F55-3	375	370F29	339	391F88-2*	376	402F34	341	409K12*	336
351F56*	375	370F31	339	391F94-8	376	402F35	341	410F13*	376
351F57*	375	370F33	340	391F96-8*	376	402F617	342	410F14*	376
351F72	375	370F35	340	391F99*	376	402F73-8	341	410F20*	376
351F73	375	370F55-8	375	392F02	376	402F98-3	377	411F96-4	376
351F79-7	375	370F56-8	375	392F05*	376	402F99*	376	411F98-7	376
351F80-7	375	370F63-8	375	392F08-8	376	402F99*	377	411L62	372
351F82-3	375	376F37*	373	392F10	376	403F03-5	376	411L62M016	343
351F83-3	375	376F42	375	392F11	376	403F30*	376	411L62M018	343
351F84-9	375	377F30-8	348	392F14-8	376	403F302 Fin	355	411L62M020	343
351F85*	375	377F80	346	392F22	372	403F56-8	342	411L63	372
351F86-7	375	378F74-5	375	392F23*	376	403F66-8	342	411L63M016	343
351F87-3	375	378K18	336	392F23-7*	376	403F67-7	341	411L63M018	343
351F88-3	375	379F25	375	392F24	372	404F85-8	342	411L63M020	343
351F89-7	375	379F26	375	392F27-9	376	404F86-8	341	412F03-7	376
351F90-7*	375	379F805	338	392F28	372	405F42-8	376	412F06-7	376
351F98-8	375	381F30	365	392F29	372	405F45-8	376	412F07-8	376
352F02-1	375	382F63-6	375	392L19*	376	405F47-6	376	412F08-7	376
352F03-8	375	382F68-6	375	392L20 x 547	376	405F49-6	376	412F09-1	376
352F04-2	372	382F69-8	376	392L20 x 568	376	405F77-2	366	412F11-7	376
352F05	372	382F72-9	376	393L13-M672*	376	405L138018	343	412F13-3*	376
352F06-8	375	382F78/8	376	393L13-M672*	377	405L138020	343	412F15-7	377
352F07*	375	382F79-8	376	393L14 x 672	376	405L138022	343	412F16-7	377
353F86-8	338	382F80-8	376	394F19-8	366	405L148018	343	412F45-1	377
354F19-8	338	382F81-8	376	397F91-8	376	405L148020	343	413F22-8	338
361F30-8	375	382F82-8	376	398F43-8	365	405L148022	343	415F16	365
361F91-3	372	382F85-8	376	398F69-8	376	406F43-8	338	415K73	336
362F15-3	338	382F86-5	376	398F89	376	407K63	336	415K74	336
362F15-3	366	382F87-8	376	398F91-9	376	407K64	336	416F35-5	372
362F42-8	338	382F88-8	376	398F94-8	376	407K65	336	416F38	366
362F43-2	338	382F95-6	376	398F95-7	376	407T31-4097 2L	337	416F39	339
362F49-8	375	382F98-6	376	398F99-7	376	407T31-4125 3L	337	416F49	342
362F50-2	338	383F82	346	399F00*	376	407T31-4153 4L	337	416F81-8	377
362F91-8	375	384F03	350	399F02-7	376	407T32-4097 2R	337	416F84	342
364F22-8	375	384F11	346	399F05-7	376	407T32-4125 3R	337	416K07	336
364F27-2	375	385F54-5	378	399F06-7	376	407T32-4153 4R	337	416K08	336
364F28-8	375	386F15-8	376	399F07-7	376	407T33-4097 2S	337	418F28-8	377
364F30-8	375	386F45-3	379	399F10-8	376	407T33-4125 3S	337	418F30-8	377
364F36*	375	387F21-8	378	399F12*	376	407T33-4153 4S	337	418F35-2	377
364F37*	375	387F24-8	378	399F13*	376	407T41-4242 2L	337	418F36-8	377

Part Number	Page	Part Number	Page	Part Number	Page	Part Number	Page	Part Number	Page
418F37-8	377	436F44-8	378	447F14	381	468F24-6	377	485F74	345
420F12-8*	377	436F80-1	378	447F14	382	468F25-6	377	486F83*	363
422F88	339	436F81-1	378	447F24	350	468F26-6	377	486F89*	363
422L84-2144	366	436F82-8	378	447F25	350	468F27-6	377	487F08	350
422L84-8144	366	436F83-8	378	447F41	339	468F30-5	379	487K10	336
423F49-8	338	436F858	378	447F42	339	468F34	381	487K11	336
423F54	341	436L32-8557	378	447F43	339	468F35-5	377	487K13	336
423F55	341	437F16	344	447F43	368	468K87	336	487K15	336
423F57	341	437F26	344	447F44	340	469F67	378	487K17	336
423F58	341	437F28	344	447F45	340	469F68	378	487K19	336
423L71	366	437F40	344	447F46	340	480F06-2	338	487K21	336
424F42-8	372	437F41	344	449F82-8	378	480F12-8	377	487K38	336
424F43-8	372	437F42	344	463F91-8	372	480F13*	377	487L048-697	379
424F52-8	372	438F37	344	463F92-8	379	480F18-8	377	487M048-589	372
424F83-8	366	438F38	344	464F02-8	377	480F19-8	377	487M048-589	379
425F86-8	341	438F41-8	338	464F91-5	377	480F20-8	377	488F00	347
426F52	345	438F42-8	338	464K97	336	480F28*	377	488F01	347
427F06	344	438F90	347	465F57	342	480F30*	377	488F03	346
427F07-8	344	439F25	344	466F22-9	342	480F33*	377	488F04	346
427F36	345	439F26	344	466F279	366	480F37-5	377	488F05	346
427F37	345	439F27	344	466F40	344	480F68	363	488F07	346
427F39	345	439F33	351	466F41	344	480F688 Fin	358	488F08-8	338
427F43	345	439F34	351	466F42	344	480F69	366	488F08-8	344
427F45	345	439F35	351	466F45	344	480F70	366	488F09	342
427F47	345	442F95-2	365	466F46	344	480F70-8	366	488F10-8	338
428F32	344	444K87	336	466F47	344	481K19	336	488F10-8	344
428F33	344	444K88	336	466F50	344	481K28	336	488F27	344
428F34	344	444K89	336	466F51	344	482F37	344	488F30	344
429F08	342	444K94	336	466F52	344	482F44-2	377	488F31	344
429F31-7	350	444K96	336	466F73	344	482F49*	377	488F32	344
429F41	342	444K97	336	466F74	344	482F73*	377	488F92-8	338
429F41	368	444K98	336	466F75	344	482F79-8	378	488F92-8	338
430F47	347	444K99	336	467F01*	351	483F11-8	348	488K84	336
432F86	351	445F31-8	351	467F33-8	366	483F30	344	488K85	336
433F48	346	445F38	348	467F34-5	366	483F34	344	488K98	336
433F49	346	445F41	351	467F35-8	366	483F35	344	488K99	336
433F76	351	445F43	348	467F36	366	483F36	344	489F88-2	365
433F77	351	445F82	350	467F37-8	366	483F79	350	489F89-2	365
433F78	351	445F83	350	467F73-3	372	483F80	350	489K49	336
433F97-8	377	445F84	350	467F94-2	377	483F81	350	492F19-5	377
433F98-8	377	445F85	351	467F95-2*	377	483F82	350	492F20	378
434F00-8	377	445F86-9	350	468F02-2*	377	483F83	350	492F21	378
434F02-8	377	446F20-8	378	468F03-2*	377	483F84	350	492F59	378
435F00	347	446F21M	379	468F12-2	377	483K01	336	492K90	336
436F03-8	372	446F22-8	379	468F13-2	377	484F20-8	378	492K91	336
436F17-7	342	446F23-1	378	468F14-7	377	484F21-8	378	492K92	336
436F25-8	378	446F57-2	338	468F15-7	377	484F41-8	377	493F29-7	337
436F29-8	378	446F58-2	338	468F16-2	377	484F74	342	493F31	350
436F41-8	378	446K68	336	468F17-2	377	484F76	347	493F34	350
436F42-8	378	447F14	380	468F20-2*	377	484F89-8	377	493F76	336
436F43-8	378	447F14	380	468F21-2*	377	484F90	346	493F77	336

Part Number	Page	Part Number	Page	Part Number	Page	Part Number	Page	Part Number	Page
493F78	336	509F49	381	544F92	345	563F905	356	582F12-2	365
494F72	383	509F49	382	544F93	345	563F905	379	582F13-2	365
494F74	383	511F51	344	544F94	346	563F945	356	582F14-2	365
494F75	383	511F52	344	544F95	346	563F945	379	584F46	350
494F76	383	511F73	348	544F96	346	563F955	356	585F31-2	338
494F77	383	518F06-7	379	544F97	346	563F955	379	585F31-2	338
494F86	383	518K73	336	544F98	346	563F965	356	585F32-7	337
494F92	383	518K74	336	544F99	346	563F965	379	585F36-7	338
494F93	383	518K75	336	545F00	346	564F115	378	585F37-7	338
494F94	383	518K76	336	545F42	346	564F128	378	585F38-7	338
496F32	365	518K77	336	545F43	346	564F345	378	585F39-7	337
496F33	365	519F09	351	545F44	346	564F378	378	585F40-7	338
496F34	365	519F10	351	545F45	346	564F408	378	585F705	356
496F68	378	519F11	351	545F79	345	564F438	378	585F705	379
496F69	378	519F12	351	545F80	345	564F688	378	585F715	356
496F71-8	366	522F93-2	338	545F81	345	564F888	378	585F715	379
497F52-8	350	523F03-8	378	545F82	345	564F898	378	585F72	379
498F84	351	523K21	336	545F83	345	564F908	378	585F729	357
498F85	351	525F99-8	378	545F84	345	564F918	378	585F76 Fin	358
498F86	348	526F16-8	378	545F85	345	564K52	336	585F762	359
498F87	348	526F32-1	378	545F86	345	564K53	336	585F762	361
498F92-8	351	526F52-7	379	545F87	345	564K59	336	585F77 Fin	358
499F30	381	526F53-3	379	545F88	345	564K60	336	585F772	359
499F30	382	526F66-2	338	546F97-8	337	565F04-8	342	585F772	361
499F59-8	372	526L51-8540	378	549F35-2	365	566F50	371	585F78 Fin	358
499F60-8*	377	526L928759	379	549F36-2	365	566F51	371	585F79 Fin	358
499F82-8	350	534F008	378	552F36-8	378	568F11	348	585F792	361
499F83-8	350	534K25	336	552F41-6	378	568F12	348	585K24	336
499F84-8	350	540F27	380	552F468	378	569F45	350	585K25	336
499F86-8	350	544F13	347	552F478	378	574F15-8	340	585K26	336
499F87-8	350	544F14	347	552F59-8	378	574F25-8	364	585K27	336
499F88-8	350	544F38	347	552F60-8	378	574F26-8	364	585K46	336
499F90-8	350	544F40	347	553F48-4	337	574F29	364	586F16	357
499F91-8	350	544F41	347	553F49-2	337	574F29 x574F25	364	586F17	357
499F92-8	350	544F42	347	553F50-2	337	574F29 x574F26	364	586F18	357
502F10	348	544F43	346	556F55-8	363	574F30	364	586F51 Fin	358
502F27	348	544F44	347	557F29	346	574F30 x574F25	364	586F512	362
502F29	348	544F45	347	557F92-8	378	574F30 x574F26	364	586F80	357
502F62	348	544F46	346	557F93-8	378	574F55	364	586F81	357
502F75	372	544F76	345	557F94-8	378	574F56	364	586F82	357
502F96	372	544F77	345	557F95-8	378	574K05	336	586F86	357
503F15	348	544F79	345	558F52-8	378	574K07	336	586F87	357
503F52	372	544F80	345	559K94	336	578F435	356	586F88	357
503F53-3	372	544F82	345	559K95	336	578F435	379	586I19	354
503F53-3	377	544F83	345	561F29	377	579F11	364	586L19	362
503F55-7	377	544F84	345	562F40-2	338	579K14	336	586L19M016	358
503F56-7	377	544F85	345	562F42-2	338	580F38	364	586L19M016	363
506F57	340	544F87	345	563F885	356	580F38-7	364	586L19M016	364
507F01	348	544F88	345	563F885	379	580K99	336	586L19M016 Fin*	358
509F49	380	544F89	345	563F895	356	581F96	351	586L19M018	358
509F49	380	544F91	345	563F895	379	582F11-2	365	586L19M018	363

Part Number	Page	Part Number	Page	Part Number	Page	Part Number	Page	Part Number	Page
586L19M018	364	596K31	336	599F94	361	600F65	359	604F28-8	363
586L19M018 Fin*	358	596K32	336	599F95	359	600F65	361	604F288 Fin	358
586L19M020	358	597F24	380	599F95	361	600F66	359	604F29-8	363
586L19M020	363	597F24	381	599F96	359	600F66	361	605F42	344
586L19M020	364	597F24	382	599F96	361	600F67	359	605F76-8	366
586L19M020 Fin*	358	597F35	380	599F97	359	600F67	361	605F77-8	366
586L19M022	358	597F52	380	599F97	361	600F68	359	605F90	365
586L19M022	363	597F52	381	599F98	359	600F68	361	606F01-8	366
586L19M022	364	597F52	382	599F98	361	600F69	359	606F02-8	366
586L19M022 Fin*	358	597F58	381	599F99	359	600F69	361	606F03-8	365
586L19M024	358	597F59	381	599F99	361	600F70	359	606K73	336
586L19M024	363	597F78	380	600F00	359	600F70	361	606K74	336
586L19M024	364	597F78	381	600F00	361	600F71	359	606K75	336
586L19M024 Fin*	358	597F78	383	600F01	359	600F71	361	606K76	336
586L19M028	358	597F92	381	600F01	361	600F72	359	606K77	336
586L19M028	363	597F92	382	600F02	359	600F72	361	606K78	336
586L19M028	364	597F93	381	600F02	361	600F73	359	606K79	336
586L19M028 Fin*	358	597F93	382	600F03	359	600F73	361	607F91-9	338
586L19M032	358	597F94	380	600F03	361	601F24	357	609F36	339
586L19M032	363	597F94	381	600F04	359	601F25	357	609F36	368
586L19M032	364	597F95	380	600F04	361	601F26	357	609F37	339
586L19M032 Fin*	358	597F95	381	600F05	359	601F283 Fin	358	609F37	368
586L19M036	358	597F96	380	600F05	361	601F69	357	609F38	339
586L19M036	363	597F96	381	600F06	359	601F829	357	610F01	339
586L19M036	364	597F97	380	600F06	361	601F829	358	610F01	368
586L19M036 Fin*	358	597F97	381	600F07	359	602F15-1	378	610F02	339
586L19M040	358	598F20	357	600F07	361	602F17-1	378	610F49	336
586L19M040	363	598F21	357	600F08	359	602F18-1	378	610K46	336
586L19M040	364	598F22	357	600F08	361	602F19-8	341	610K48	336
586L19M040 Fin*	358	598F59 Fin	358	600F09	359	603F20-7	337	610L43	366
586L19M044	358	598F592	360	600F09	361	603F55	381	610L44	366
586L19M044	363	598F592	362	600F10	359	603F55	383	612K88	336
586L19M044	364	598F809	360	600F10	361	603F57	381	612K90	336
586L19M044 Fin*	358	598F809	362	600F11	359	603F57	383	612K91	336
586L19M048	358	598F815	360	600F11	361	603F64	378	612K93	336
586L19M048	363	598F815	362	600F12	359	604F228	360	612K94	336
586L19M048	364	598F825	360	600F12	361	604F228	362	613F02-9	365
586L19M048 Fin*	358	598F825	362	600F13	359	604F22-8	363	613F10-2	365
596F61-8	363	598F835	360	600F13	361	604F228 Fin	355	613F11-2	365
596F618 Fin	358	598F835	362	600F14	359	604F228 Fin	358	613F12-2	365
596F62-8	363	598F905	360	600F14	361	604F23-8	363	613F13-2	365
596F628 Fin	358	598F905	362	600F415	356	604F238 Fin	358	613F14-2	365
596F63-8	363	599F275	360	600F415	379	604F24-8	363	613F15-2	365
596F66	357	599F275	362	600F425	356	604F248 Fin	358	613F16-2	365
596F67	357	599F91	359	600F425	379	604F25-8	363	613F17-2	365
596F68	357	599F91	361	600F62	359	604F268	360	613F22-2	365
596F825	356	599F92	359	600F62	361	604F268	362	613F23-2	365
596F825	379	599F92	361	600F63	359	604F26-8	363	613F24-2	365
596F87-9	338	599F93	359	600F63	361	604F268 Fin	358	613F25-2	365
596K29	336	599F93	361	600F64	359	604F27-8	363	613F35-2	365
596K30	336	599F94	359	600F64	361	604F278 Fin	358	613F42-2	365

Part Number	Page	Part Number	Page	Part Number	Page	Part Number	Page	Part Number	Page
613F43-2	365	628K902 x Fin	336	650F46-8	367	651F42-5	371	652F59	369
615F51	381	628K952 x Fin	336	650F48-9	369	651F43-8	371	652F59	370
615F51	382	628K972 x Fin	336	650F49-8	369	651F44-8	371	652F60	369
615F52	381	628K992 x Fin	336	650F50-8	368	651F47-8	371	652F61	369
615F52	382	629F062 x Fin	337	650F51-8	368	651F49-8	371	652F61	370
615F53	381	629F072 x Fin	337	650F52-8	367	651F50-8	371	652F62	369
615F53	382	629K002 x Fin	336	650F53-8	368	651F53-8	371	652F62	370
615F54	381	629K012 x Fin	336	650F54-8	369	651F54-5	371	652F63	369
615F54	382	629K022 x Fin	336	650F55-8	369	651F56-8	371	652F64	369
615F55	381	629K032 x Fin	336	650F56-8	369	651F57-8	371	652F64	370
615F55	382	629K042 x Fin	336	650F57-8	368	651F58-7	371	652F65	369
615F56	381	630F482 x Fin	337	650F58-8	367	651F60-8	371	652F65	370
615F56	382	630F494	337	650F59-8	367	651F61-8	371	652F66	369
615F58	381	630K472 x Fin	336	650F60 fin	369	651F62-8	371	652F67	369
615F58	382	631F248	356	650F62	368	651F63-8	371	652F67	370
615F59	381	649F99 fin	367	650F63	368	651F64-8	371	652F68	369
615F59	382	650F03	367	650F64	367	651F65-5	371	652F68	370
615F60	381	650F04	367	650F67-8LR	368	651F67-5	371	652F69	369
615F60	382	650F05	367	650F67-8RR	368	651F70-8	371	652F70	369
616F07-8	350	650F06	367	650F69-8LR	368	651F73-8	371	652F70	370
616F08-8	350	650F07	367	650F69-8RR	368	651F75-8	371	652F71	369
616F12	342	650F08	367	650F71-8	369	651F82-8	371	652F71	370
622F308	356	650F09-5	369	650F72-8	369	651F83-8	371	652F72	369
622F308	359	650F10-5	369	650F73-8	369	651F84-8	371	652F73	369
622F308	361	650F11	367	650F77-8	367	651F85-8	371	652F73	370
622F68	377	650F12	367	650F79-8	367	651F86-8	371	652F74	369
622F69-8	338	650F13	367	650F80-8	369	651F87-8	371	652F74	370
622F728	338	650F14	367	650F81-8	369	651F88-8	371	652F75	369
624F42-7	342	650F15	367	650F82-8	368	651F89-8	371	652F76	369
624F43-9	342	650F16	367	650F87-8	368	651F92-8	371	652F76	370
624F44-9	342	650F18-9	367	650F88-8	368	651F93-8	371	652F77	369
624F45-5	342	650F21	367	650F93	367	651F94-8	371	652F77	370
624F47-8	342	650F22-8	367	650F959	368	651F96-5	371	652F78	369
624F48-8	341	650F23-8	367	650F96-8	367	651F98-8	371	652F79	369
624F49	341	650F24-8	367	650F97-8	368	652F04-8	371	652F79	370
624F53	341	650F27-9	368	650F99-8	367	652F05-8	371	652F80	369
626F077	338	650F27-9	378	650L65	368	652F06-8	371	652F80	370
628F10-7-142	337	650F28-8	368	650L65-7020	368	652F09-8	371	652F81	369
628F10-7-171	337	650F30-8	368	651F00	370	652F10-8	371	652F82	369
628F10-7-236	337	650F31-8	368	651F01	370	652F11-8	371	652F82	370
628F825	338	650F35-8	367	651F04	370	652F12-8	371	652F83	369
628F835	338	650F36-8	367	651F06	370	652F13-8	371	652F83	370
628F892	337	650F37-8	367	651F08	370	652F14-8	371	652F84	369
628F912	337	650F38-8	367	651F09	370	652F15-8	371	652F85	369
628F922 x Fin	337	650F39-8	367	651F10	370	652F21-8	371	652F86	369
628F932	338	650F40-8	367	651F36-2	371	652F22-8	371	652F87	369
628F932	339	650F41-8	367	651F37-2	371	652F23-9	371	652F88	369
628F962	337	650F42-8	367	651F38-9	371	652F29-8	368	652F89	369
628K852 x Fin	336	650F43-8	367	651F39-8	371	652F57	369	652F90	369
628K872 x Fin	336	650F44-8	367	651F40-8	371	652F58	369	652F92	369
628K882 x Fin	336	650F45-8	367	651F41-8	371	652F58	370	652F93	369

Part Number	Page	Part Number	Page	Part Number	Page	Part Number	Page	Part Number	Page
652F95	369	653F74	369	670F36	349	678F248	362	682F86 Fin	358
652F96	369	653F74	370	670F37	349	678F25	379	682F87 Fin	358
652F99	369	653F75	369	670F38	349	678F25 Fin	358	682F91	379
653F02	369	653F75	370	670F57	349	678F252	360	682F91-8	338
653F03	369	653F76	369	670F58	349	678F252	362	682F958	356
653F04	369	653F76	370	670F59	349	678F252 Fin	353	682F958	359
653F05	369	653L15-7014	368	670F60	349	678F498	358	682F958	361
653F08	369	653L16-3016	368	670F61	349	678F498	362	682F969	356
653F09	369	653L16-3020	368	670F62	349	678F54-8	341	682F969	359
653F10	369	653L18-3016	368	670F63	349	678F67-7	341	682F969	361
653F12	367	653L18-3020	368	670F64	349	679F818 pgs: 355,360,357,358		684F05-5	342
653F13	367	654F07	339	670F65	349	680F34-8	351	684F06-8	342
653F14	367	654F08	339	670F66	349	680F35-8	351	684F09-8	342
653F50	369	654F20-8	368	670F67	349	680F36-8	351	684F10-8	342
653F50	370	654F21-8	368	670F68	349	680F64-5	338	684F11-9	342
653F53	369	655F02-8	371	670F69	349	680F64-5	338	684F12-9	342
653F53	370	655F15	368	670F70	349	680L50	362	684F14-7	342
653F54	369	655F16	368	670F71	349	680L51	362	684F42	368
653F54	370	655F17	368	670F72	349	680L52	362	684F427	368
653F55	369	655F48-8LR	368	670F73	349	681F30	341	684F44 Fin	358
653F55	370	655F48-8RR	368	670F74	349	681F31	341	684F448	360
653F56	369	655F54-8	371	671F02	349	681F36-8	341	684F448	362
653F56	370	655F69-8	371	671F03	349	681F37-8	341	684F45 Fin	358
653F57	369	655F70-8	371	671F04	349	681F40	341	684F46 Fin	358
653F57	370	655F71-8	368	671F05	349	681F41	341	684F528	358
653F59	369	656F40-8	368	671F06	349	681F44-8	342	684F528	360
653F59	370	656F41	368	671F07	349	681F48-9	341	684F528	362
653F60	369	656F44	369	671F08	349	681F60-8	367	684F539	362
653F60	370	656F45	369	671F09	349	681F61-8	367	684F55-9	341
653F61	369	656F46	369	671F10	349	681F63	367	684F775	357
653F61	370	656F47	369	677F04	370	681F70-8	369	684F775	362
653F62	369	656F48	369	677F05	370	681F71-8	369	684F785	357
653F62	370	656F49	369	677F06-8	371	681F76-8	369	684F785	362
653F63	369	656F50	369	677F09-8	371	681F77-8	369	684F795	357
653F63	370	656F51	369	677F13	370	682F01-8	342	684F795	362
653F65	369	656F52	369	677F14	370	682F298	356	684F805	357
653F65	370	656F53	369	677F15	370	682F298	359	684F805	362
653F66	369	656F58	370	677F16	370	682F298	361	684F815	357
653F66	370	656F59	370	677F26	370	682F398	356	684F815	362
653F68	369	656F60	370	677F27	370	682F398	359	684F825	357
653F68	370	656F61	370	677F28	370	682F608	358	684F825	362
653F69	369	656F62	370	677F42	336	682F618	358	684F835	357
653F69	370	656F63	370	677F768LR 626	371	682F628	358	684F835	362
653F70	369	656F64	371	677F768RR 626	371	682F638	358	684F845	357
653F70	370	656F65-8	371	677F778LR 626	371	682F64 Fin	358	684F845	362
653F71	369	656F66-8	368	677F778RR 626	371	682F65 Fin	358	684F855	357
653F71	370	670F31	349	678F00-8LR	368	682F67 Fin	358	684F855	362
653F72	369	670F32	349	678F00-8RR	368	682F68 Fin	358	684F865	357
653F72	370	670F33	349	678F02-8	371	682F788	358	684F865	362
653F73	369	670F34	349	678F248	358	682F788	360	684F875	362
653F73	370	670F35	349	678F248	360	682F788	362	684F885	357

Part Number	Page	Part Number	Page	Part Number	Page	Part Number	Page	Part Number	Page
684F885	362	688F95	380	691F72	381	694F332	352	695F252236 - .236"	337
685F38-7	342	688F95	380	691F72	382	694F352	352	695F252252 - .252"	337
685F505	379	688F95	381	691F74	381	694F392	352	695F252267 - .267"	337
685F515	379	688F95	382	691F74	382	694F442	352	695F252283 - .283"	337
685F525	379	689F01	380	691F78	381	694F482	352	695F252299 - .299"	337
685F535	379	689F01	381	691F89	381	694F522	352	695F257031 - .031"	337
685F545	379	689F01	382	691F90	381	694F562	352	695F257047 - .047"	337
685F555	379	689F02	380	691F93	381	694F602	352	695F257063 - .063"	337
685F875	357	689F02	381	691F94	381	694F682	352	695F257078 - .078"	337
686F858	356	689F02	382	691F96	381	694F722	352	695F257094 - .094"	337
686F858	359	689F03	380	691F96	382	694F76	370	695F257110 - .110"	337
686F858	361	689F03	381	691F98	380	694F802	352	695F257126 - .126"	337
686F868	356	689F03	382	691F99	380	695F042 x Fin	337	695F257141 - .141"	337
686F868	359	689F04	380	692F00	381	695F052 x Fin	337	695F257157 - .157"	337
686F868	361	689F04	381	692F01	381	695F075	356	695F257173 - .173"	337
686F88 Fin	358	689F04	382	692F02	380	695F18	370	695F257189 - .189"	337
686F882	362	689F12	381	692F02	381	695F22	378	695F257204 - .204"	337
687F53-8	341	689F12	383	692F03	380	695F23	378	695F257220 - .220"	337
687F54-8	341	689F13	381	692F03	381	695F244139 - .139"	337	695F257236 - .236"	337
687F55-8	341	689F14	381	692F04	381	695F244155 - .155"	337	695F257252 - .252"	337
687F56-8	341	689F15	381	692F04	382	695F244171 - .171"	337	695F257267 - .267"	337
687F60	360	689F16	381	692F05	381	695F244187 - .187"	337	695F257283 - .283"	337
687F60	364	689F17	381	692F05	382	695F244202 - .202"	337	695F257299 - .299"	337
687F61	360	689F18	381	692F14	380	695F244218 - .218"	337	696F05	379
687F61	364	689F19	381	692F14	383	695F244234 - .234"	337	696F318	378
687F62	360	689F28	348	692F15	380	695F244250 - .250"	337	696F39	351
687F62	364	689F30	348	692F15	383	695F244265 - .265"	337	696F42	338
687F63	360	689F31	348	692F16	380	695F244281 - .281"	337	696F42	339
687F63	364	689F33	348	692F16	383	695F247139 - .139"	337	696F472	337
687F64	360	689F37	348	692F17	383	695F247155 - .155"	337	696F499	337
687F64	364	689F39	348	692F19	383	695F247171 - .171"	337	696F502 x Fin	337
687F65	360	689F50	348	692F20	383	695F247187 - .187"	337	696F51	338
687F65	364	689F51	348	692F21	383	695F247202 - .202"	337	696F51	339
687F66	360	689F52	348	692F23	383	695F247218 - .218"	337	696F57-8	351
687F66	364	689F53	348	692F24	383	695F247234 - .234"	337	696F58-8	351
687F71	360	689F54	348	692F25	383	695F247250 - .250"	337	696F59-8	351
687F71	364	689F55	348	692F632	352	695F247265 - .265"	337	696K43	336
687F94	360	689F58	348	692F642	352	695F247281 - .281"	337	696K45	336
687F94	364	689F60	348	692F652	352	695F252031 - .031"	337	696K46	336
687F95	360	689F62	348	692F662	352	695F252047 - .047"	337	696K48	336
687F95	364	690F44	379	692F672	352	695F252063 - .063"	337	696K52	336
687F96	360	690F82-7	342	692F752	352	695F252078 - .078"	337	697F33-8	368
687F96	364	690F975	356	692F762	352	695F252094 - .094"	337	697F34-8	368
688F01-7	342	690F985	357	692F862	352	695F252110 - .110"	337	697F35-8	368
688F03-8	342	690F985	362	692F932	352	695F252126 - .126"	337	697F36-8	368
688F14-8	341	691F52	381	692F942	352	695F252141 - .141"	337	697F50	338
688F17-7	342	691F53	381	692F952	352	695F252157 - .157"	337	697F50	339
688F77	380	691F54	381	692F962	352	695F252173 - .173"	337	697F507	337
688F77	380	691F55	381	693F20-8	366	695F252189 - .189"	337	697F862	367
688F77	381	691F56	381	694F312	352	695F252204 - .204"	337	697F942	356
688F77	382	691F57	381	694F322	352	695F252220 - .220"	337	697F942	361



Part Number	Page	Part Number	Page	Part Number	Page	Part Number	Page	Part Number	Page
697F98-8	378	701F237	337	711F395	342	712F765	357	720F65	351
697F995	357	701F60	368	712F205	356	712F775	357	721F16	351
698F03-8	367	701F61	368	712F215	356	712F785	357	721F17	351
698F31	370	701F62	368	712F225	356	712F795	357	721F18	351
698F32	370	701F63	368	712F235	356	713F518	368	721F19	351
698F33	370	701F70-5	342	712F265	356	713F528	368	723F69	351
698F34	370	702F98-7	341	712F275	356	713F908	368	723F26	351
698F43	379	703F997	342	712F305	357	713F938	368	733F05	370
698F44	379	704F269	367	712F315	357	713F948	368	733F41	370
698F45	379	704F279	367	712F325	357	713F958	368	733F42	370
698F46	379	704F479	367	712F335	357	713F988	368	733F43	370
698F51	379	704F489	367	712F345	357	713F998	368	733F44	370
698F52	379	704F569	367	712F355	357	714F005	356	733F45	370
698F53	379	704F579	367	712F365	357	714F035	356	733F46	370
698F64	370	704F589	367	712F375	357	714F065	356	733F47	370
698F65	370	704F599	367	712F385	356	714F125	356	733F48	370
698F66	370	704F62	368	712F395	356	714F155	357	733F49	370
698F67	370	704F63	368	712F405	356	714F185	357	733F50	370
698F68	370	704F64-8	368	712F415	356	714F215	357	733F51	370
698F69	370	704F658	368	712F425	356	714F255	356	733F52	370
698F70	370	704F66	368	712F435	356	714F275	357	733F53	370
698F71	370	706F00-5	371	712F445	357	714F305	356	741F21	351
700F16-8	351	706F01-5	371	712F455	357	714F315	356	741F22	351
700F21-8	341	706F03-8	367	712F465	357	714F365	356	741F23	351
700F22-8	341	706F04-8	367	712F475	357	714F375	356	741F24	351
700F25-8	342	706F05-8	367	712F485	357	714F425	356	744F208	368
700F278	341	706F06-8	367	712F495	357	714F455	356	744F258	368
700F36-7	351	706F07-8	367	712F505	356	714F485	357	744F662	337
700F37-8	351	706F08-8	367	712F515	356	714F495	357	744F688	368
700F42	347	706F09-8	367	712F525	356	714F545	357	751F16	346
700F43	347	706F10-8	367	712F535	356	714F555	357	751F17	346
700F44	347	706F15	367	712F545	356	714F605	357	753F598	355
700F45	347	706F16	367	712F555	356	714F635	357	754F02	383
700F46	347	706F46-2	368	712F565	356	715F152	337	754F03	383
700F47	347	706F70	351	712F575	356	715F245	356	754F04	383
700F575	338	707F57	351	712F605	357	715F892	338	754F05	383
700F65	351	707F58	351	712F615	357	715K14	336	754F09	380
700F66	351	707F59	351	712F625	357	716K16	336	754F09	381
700F67	351	707F60	351	712F635	357	716K43	336	754F09	382
700F70-8	342	710F00M	368	712F645	357	716K45	336	754F10	380
700F74-8	342	710F31-8LR	368	712F655	357	716K46	336	754F10	381
700F80	347	710F31-8RR	368	712F665	357	716K48	336	754F10	382
700F81	347	710F32-8LR	368	712F675	357	720F21	351	754F12	381
700F82	347	710F32-8RR	368	712F685	356	720F22	351	754F12	382
700F83	347	710F33-8LR	368	712F695	356	720F24	351	754F13	381
700F84	347	710F33-8RR	368	712F705	356	720F25	351	754F13	382
700F86	347	710F618	358	712F715	356	720F43	341	754F14	380
700F87	347	710F628	358	712F725	356	720F46	341	754F14	381
700F90-7	341	710F658	358	712F735	356	720F61	351	754F14	382
700F95-7	342	710F668	358	712F745	357	720F62	351	754F15	380
701F22-8	341	711F002	351	712F755	357	720F64	351	754F15	381

Part Number	Page	Part Number	Page	Part Number	Page	Part Number	Page	Part Number	Page
754F15	382	756F567	338	776F575	353	778F215	353	780F208	355
754F16	381	756F582	338	776F585	353	778F225	353	780F215	353
754F16	381	756F963	366	776F638	354	778F235	353	780F225	353
754F16	382	763F002243	337	776F648	354	778F245	353	780F235	353
754F17	382	763F002273	337	776F658	354	778F335	353	780F245	353
754F18	382	763F002303	337	776F668	354	778F345	353	780F335	353
754F19	382	763F002333	337	776F678	354	778F395	353	780F345	353
754F20	382	763F002363	337	776F688	354	778F405	353	780F395	353
754F21	382	763F002393	337	776F698	354	778F415	353	780F405	353
754F22	382	763F012030	337	776F708	354	778F425	353	780F415	353
754F23	382	763F012060	337	776F718	354	778F515	353	780F425	353
754F24	382	763F012090	337	776F728	354	778F525	353	780F515	353
754F25	382	763F012120	337	776F738	354	778F575	353	780F525	353
754F26	382	763F012150	337	776F748	354	778F585	353	780F575	353
754F29	382	763F012180	337	776F758	354	778F638	355	780F585	353
754F30	382	763F012210	337	776F768	354	778F788	354	780F638	355
754F34	382	763F012240	337	776F778	354	778F812	355	780F648	354
754F35	382	763F012270	337	776F788	354	778F868	355	780F658	354
754F36	382	763F012300	337	776F798	354	778F888	354	780F662	354
754F37	382	763F012330	337	776F808	354	778F898	354	780F808	354
754F38	382	763F027120	337	776F818	354	778F90 Fin	353	780F81 Fin	354
754F43	381	763F027150	337	776F828	354	778F91 Fin	355	780F82 Fin	354
754F44	381	763F027180	337	776F838	354	778F968	355	780F83 Fin	354
754F45	381	763F027210	337	776F848	354	778F97 Fin	353	780F84 Fin	354
754F46	382	763F027240	337	776F858	354	779F215	353	780F85 Fin	354
754F52	383	763F027270	337	776F868	354	779F225	353	780F86 Fin	354
754F53	383	763F072	337	776F878	354	779F235	353	780F87 Fin	354
754F54	383	775F808	354	776F918	354	779F245	353	780F88 Fin	354
754F55	383	775F818	354	776F928	354	779F335	353	780F89 Fin	354
754F56	383	775F828	354	776F938	354	779F345	353	780F90 Fin	354
754F57	383	775F838	354	776F948	354	779F395	353	780F91 Fin	354
754F58	383	775F908 Fin	355	776F958	354	779F405	353	780F92 Fin	354
754F59	383	775F918 Fin	355	776F968	354	779F415	353	780F93 Fin	354
754F61	383	775F948	354	776F978	354	779F425	353	780F94 Fin	354
754F62	383	776F002 Fin	354	776F988	354	779F515	353	780F95 Fin	354
754F63	383	776F012 Fin	354	776F998	354	779F525	353	780F96 Fin	354
754F64	383	776F022 Fin	354	777F208	354	779F575	353	783F06	370
754F65	380	776F032 Fin	354	777F215	353	779F585	353	783F208	356
754F66	383	776F042 Fin	354	777F225	353	779F638	354	783F308	356
754F68	380	776F215	353	777F235	353	779F648	354	783F408	356
754F69	380	776F225	353	777F245	353	779F658	354	785F008	356
754F70	380	776F235	353	777F335	353	779F728	354	785F018 Fin	356
754F71	383	776F245	353	777F345	353	779F738	354	785F028 Fin	356
754F72	383	776F335	353	777F395	353	779F748	354	785F038	356
754F73	383	776F345	353	777F405	353	779F758	354	785F048	356
754F78	380	776F395	353	777F415	353	779F787	355	785F058	356
754F79	380	776F405	353	777F425	353	779F797	355	785F068	356
754F80	380	776F415	353	777F515	353	779F807	355	785F078 Fin	356
754F81	380	776F425	353	777F525	353	779F97 Fin	353	785F088	356
754F84	382	776F515	353	777F575	353	779F98 Fin	353	785F088	356
756F507	338	776F525	353	777F585	353	779F99 Fin	353	785F108	356

Part Number	Page	Part Number	Page	Part Number	Page	Part Number	Page	Part Number	Page
785F118 Fin	356	791F85 Fin	366	797F818	362	799F555	356		
785F128 Fin	356	791F86 Fin	366	797F828	360	799F565	356		
785F138 Fin	356	791F87 Fin	366	797F828	362	799F575	356		
785F148	356	794F509	383	797F838	362	799F585	356		
785F158 Fin	356	794F519	383	797F845	360	799F595	356		
785F168	356	794F529	383	797F845	362	799F605	357		
785F178	356	794F539	383	797F855	360	799F615	357		
785F188	356	796F118	360	797F855	362	799F625	357		
785F198	356	796F118	362	797F865	360	799F635	357		
785F218 Fin	356	796F208	359	797F865	362	799F645	357		
785F228	356	796F218	359	797F875	360	799F655	357		
785F238	356	796F228	359	797F875	362	799F665	357		
785F248	356	796F238	359	797F915	360	799F675	357		
785F258	356	796F248	359	797F915	362	799F685	357		
785F268 Fin	356	796F258	359	797F925	360	799F695	357		
785F278	356	796F268	359	797F925	362	799F805	356		
785F288	356	796F30 x Fin	366	797F935	360	799F815	356		
785F298	356	796F318	359	797F935	362	799F825	356		
785F308	356	796F328	359	797F945	360	799F835	356		
785F318 Fin	356	796F338	359	797F945	362	799F845	357		
785F328	356	796F358	359	798F115	360	799F855	357		
785F338	356	796F368	359	798F115	362	799F865	357		
785F348	356	796F378	359	798F125	360	799F875	357		
785F358	356	796F378	361	798F125	362	∅ 195F67	373		
785F378 Fin	356	796F388	359	798F135	360	∅ 236L718018	377		
785F388 Fin	356	796F398	359	798F135	362	∅ 326F73-7	375		
790F208	355	796F398	359	798F145	360	∅ 391F90-9	376		
790F215	353	796F398	361	798F145	362	∅ 399F16-8	377		
790F225	353	796F408	359	798F155	360	∅ 399F58-8	376		
790F235	353	796F408	361	798F155	362	∅ 405F46-6	376		
790F245	353	796F43	366	798F165	360	∅ 409F83-6	3676		
790F335	353	796F46 x Fin	366	798F165	362				
790F345	353	797F618	361	798F175	360				
790F395	353	797F628	361	798F175	362				
790F405	353	797F638	361	798F185	360				
790F415	353	797F648	361	798F185	362				
790F425	353	797F658	361	798F215	362				
790F515	353	797F668	361	798F225	362				
790F525	353	797F678	361	798F235	362				
790F575	353	797F688	361	798F245	362				
790F585	353	797F698	361	798F255	362				
790F988	355	797F708	361	798F265	362				
790F988	355	797F718	361	798F275	362				
790F998	355	797F728	361	798F285	362				
790F998	355	797F738	361	798K912 x Fin	336				
791F51 x Fin	366	797F748	361	798K922 x Fin	336				
791F59	351	797F758	361	799F505	356				
791F60	351	797F768	361	799F515	356				
791F82 Fin	366	797F778	361	799F525	356				
791F83 Fin	366	797F788	361	799F535	356				
791F84 Fin	366	797F808	361	799F545	356				





**ASSA ABLOY**

**Notes**





For more information regarding Corbin Russwin Locksets, Exit Devices, Door Controls and Key Systems, contact your authorized Corbin Russwin Distributor or Sales Representative.



**Corbin Russwin Architectural Hardware**

225 Episcopal Road  
Berlin, CT 06037  
Phone 800-543-3658  
Fax 800-447-6714  
[www.corbinrusswin.com](http://www.corbinrusswin.com)

**Notice:** This price book takes precedence over the catalog as to the correctness and availability of items in our entire line.

Corbin Russwin and Design®, Corbin®, Russwin®, and Design® Access 800®, Muséo®, and SecureBolt® are registered trademarks of Corbin Russwin, Inc., an ASSA ABLOY Group company. Safeguard™, PathLite™ and Vineyard™ are trademarks of Corbin Russwin, Inc. an ASSA ABLOY Group company. Unitrol® is a registered trademark of Yale Security Inc., an ASSA ABLOY Group company. These materials are protected under US copyright laws. All contents current at time of publication. Corbin Russwin Inc., an ASSA ABLOY Group company reserves the right to change availability of any item in this catalog, its design, construction, and/or its materials. Other products' brand names may be trademarks or registered trademarks of their respective owners and are mentioned for reference purposes only.

Copyright © 2002 - 2017 Corbin Russwin, Inc., an ASSA ABLOY Group company. All rights reserved. Reproduction in whole or in part without the express written permission of Corbin Russwin, Inc. is prohibited.