

**SCHLAGE**

# Everest 29™ SL

Service manual

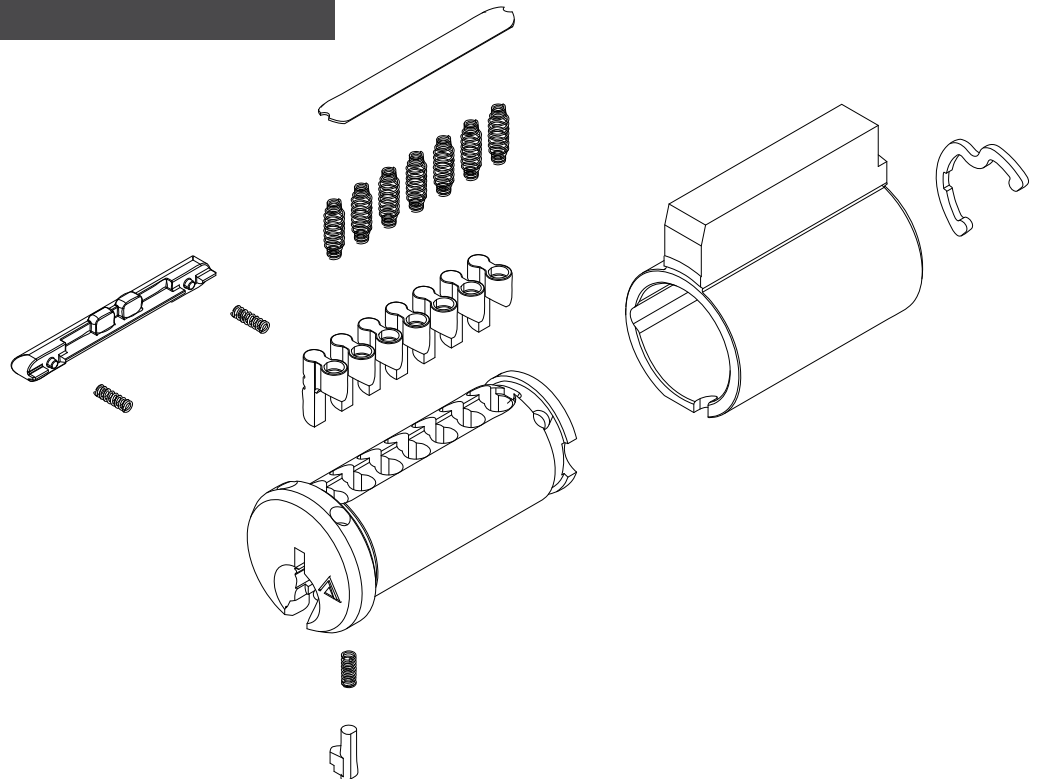



# Contents

- 5 Introduction
- 5 Key systems
  - SL compatibility
  - Primus and Primus XP compatibility
  - Everest Primus XP compatibility
  - Serviceability
  - Everest compatibility
- 7 Terminology
  - Keyways
  - Cylinder mechanisms
  - Primus cylinders
  - Key control
  - Cylinder category
- 9 Cylinders
- 9 Modular cylinders
  - Key-in-knob to modular mortise or rim cylinder conversion
  - Cam and tailpiece differences
- 10 Everest 29 SL
  - Order of installation
  - Operating principles
- 11 Everest 29 SL Primus XP
  - Order of installation
  - Operating principles
- 12 Key-in-knob/key-in-lever cylinders
  - Schlage lock sets
  - Key-in-knob/key-in-lever competitive cylinders, Everest 29 Keyway
- 14 Deadlock cylinders
- 14 Cap pin location
  - Everest 29 SL
  - Everest 29 SL Primus XP
- 14 Tailpiece orientation
  - Cabinet locks
  - Rim cylinders
- 15 Mortise cylinders
  - Everest 29 SL cylinder cams to operate other manufacturers' locks
- 16 Pins, springs and sidebars
- 17 Rekeying
- 18 How to pin SFIC vs. Everest 29 SL
  - SFIC pinning
  - Everest 29 SL pinning
- 19 Keys
- 19 Key Bitting Specifications
  - Reading the L pin
  - Reading Primus/Primus XP finger pins
- 20 Reading keys
  - Standard cuts
  - Side bit cuts
- 21 Compatible keys
- 22 Key control levels overview
  - Dealer controlled systems
  - End user exclusive systems
- 23 Everest 29 Primus XP Level 9
  - Overview for end user
  - Level 9U (universal)
  - Level 9G (geographical)
  - Level 9Z (time zone)
  - Level 9N (nationwide)
  - Overview for locksmith or security dealer
  - Keyways and keying options
- 24 Key control procedures: end user controlled systems
  - Electronic Validation
  - Signature verification
  - Primus signature card
  - Primus face sheet form
- 25 Three parts to key control
  - 1. Key issue policies
  - 2. Track issued keys with SiteMaster 200
  - 3. Use patented keys
- 27 Tools, kits and accessories
- 27 Pin kits
- 28 Bulk packs
  - 10-Piece Bulk Packs for Unassembled Everest and Everest 29 SL Cylinders
- 31 Troubleshooting
- 34 Interpreting box labels

## Contents

# Introduction



## Key systems

Patented key systems prevent unauthorized duplication of keys providing greater key control and reduced threat of a compromised key system. Everest 29 keyway families provide the flexibility to secure and restrict the most sensitive openings in a facility while maintaining access control across the entire system.

Everest 29™ is patent protected through 2029 and delivers a higher level of security because it cannot be duplicated without authorization. The backward compatibility of Everest 29 keyways to the legacy Everest keyways provides you with flexibility and security that adapts to your needs. Everest 29 keys will work in existing Everest keyways, but original Everest keys will not work in new Everest 29 keyways. This is because of the patent enabling feature of Everest 29 and what prohibits duplication of the new Everest 29 keys.

Everest 29 and Everest key systems can be enhanced and restricted to limited distribution with the addition of Primus XP. Primus XP, Schlage's high security sidebar cylinder mechanism, introduces an added level of security control. It delivers patented key control, geographical exclusivity, and pick resistance with the option of adding UL 437 drill resistance.

Whether you're retrofitting a building or implementing a key system for a newly constructed complex, Schlage key systems deliver the security you need at every level throughout your building, campus, or worldwide facility.

Everest 29 keyway			Everest keyway			
EVEREST 29 PRIMUS XP	EVEREST 29 PRIMUS	EVEREST 29	EVEREST PRIMUS XP	EVEREST PRIMUS	EVEREST	
•	•	•				Patented until 2029
			•			Patented until 2024
•	•	•	•	•	•	Commercial applications
•	•		•	•		Maximum key duplication restrictions
		•		•	•	Some key duplication restrictions
						No key duplication restrictions
		•			•	SFIC available
		•			•	Check pin
•	•		•	•		Finger pins/side bar configuration
•			•			#7 Finger pin used for added security
•	•	•	•	•	•	Bulk pack available
•	•	•	•	•	•	Master keying available for all levels
						Master keying available for levels 1+, 2, 3 and 4
						Master keying available for levels 2, 3 and 4
		•			•	 EVEREST 29 SL
•		•	•		•	 EVEREST 29 SL PRIMUS XP

**Introduction**

**SL compatibility**

The Everest 29™ SL cylinder provides users capabilities never before offered by Schlage. The SL key fits into full size cylinders and Small Format Interchangeable Cores (SFIC). Buildings on multiple key systems – reducing complexity and cost, without sacrificing security.

**Primus and Primus XP compatibility**

The Everest 29 SL and Everest 29 SL w/ Primus XP cylinders fit into Schlage KIL/KIK, Mortise and Rim modular cylinders as well as an extensive list of competitor’s cylindrical locks. Cylinders pin to new and existing restricted Everest B and Everest 29 R key systems.

**Everest Primus XP compatibility**

Everest 29 SL and Everest 29 SL Primus XP cylinders can be incorporated into any system using Everest 29 R and Everest B keyways including master keyed systems with no adverse effects on the system’s expansion.

**Serviceability**

Schlage has created a unique pinning kit and staking tool that is needed to service SL cylinders. The side biting is cut into the key blanks at the factory and the keys are able to be combined using standard key cutting equipment.

**Everest compatibility**

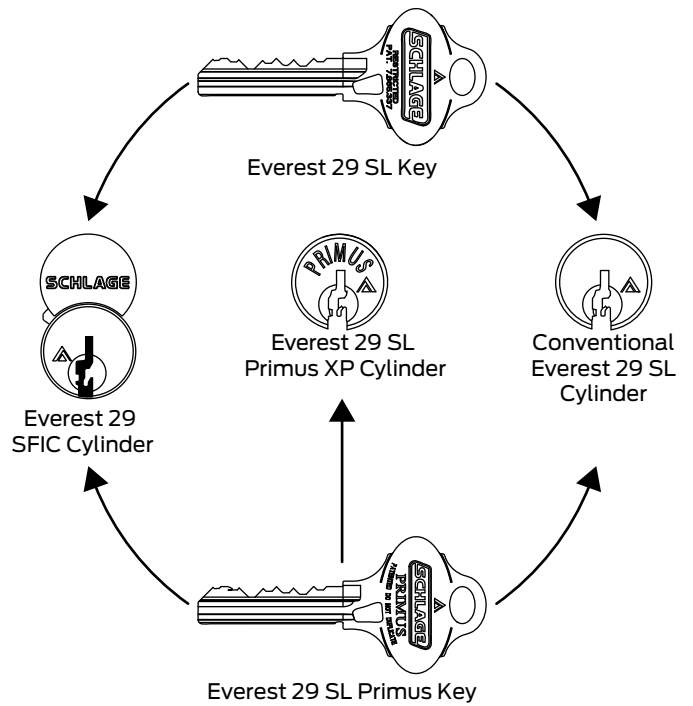

Cylinder differences			
	SFIC	Everest 29 SL	Everest 29 SL Primus XP
<b>Keys and key bows</b>			
	<ul style="list-style-type: none"> <li>Standard key is embossed on one side. Plain bow available.</li> <li>20% larger than Classic keys with a larger stamping area on key bow.</li> </ul>		<ul style="list-style-type: none"> <li>The word “Primus” is stamped on the front of the key bow.</li> <li>Standard key is embossed on one side. Plain bow available.</li> <li>20% larger than Classic Primus keys with a larger stamping area on key bow.</li> </ul>
<b>U.S. Patents</b>	US 5,715,717; 5,809,816; 7,665,337		US 5,715,717; 5,809,816; 7,159,424; 7,665,337
<b>Id numbers</b>	ID numbers stamped on every key.		
<b>Key sections stamping</b>	Standard. Key sections stamped on all keys and plugs		
<b>Master keying*</b>	Available for all sections and all levels.		
<b>(Nominal) key thickness</b>	.106”		
<b>#7 Finger pin available</b>	No	Yes	

\* Ordering Primus master keyed products is similar to ordering any other Schlage master keyed products with the one addition of the necessary Primus forms. Contact customer service for face sheet and signature form.

# Terminology

## Keyways

### Everest and Everest 29 SFIC

Keys and keyway families that are compatible with SFIC and SL cylinders have the patented undercut groove on the right side of the key section

Everest 29 refers to the R keyway family (for SFIC) and is restricted

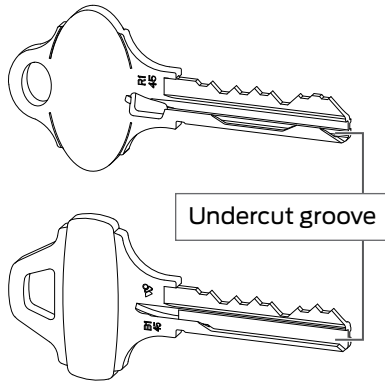

## Cylinder mechanisms

### SL cylinders

SL cylinders incorporate the use of Schlage-designed L pins with a locking sidebar.

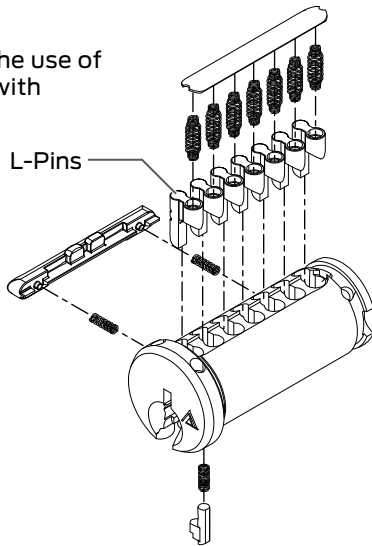

### Primus cylinders

Schlage's high security sidebar cylinder mechanism provides key control, geographical exclusivity, and pick resistance. UL437 drill resistance is optional. Everest B and Everest 29 R Primus XP keys will operate the SL Primus XP, SL cylinder and Everest and Everest 29 Small Format Interchangeable Core conventional cylinders.

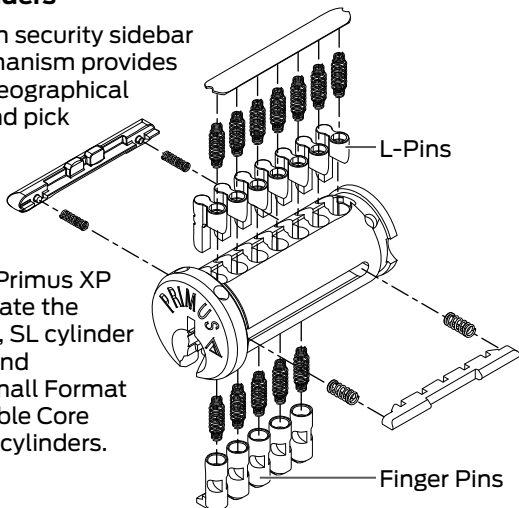

## Key control

### Restricted keyways

Special non-stock keyways set aside for limited use and a higher degree of key control.

A letter of authorization from the end user is required to process orders for Restricted keys, blanks, and cylinders.

### Open keyways

Standard keyways available without any ordering formalities. S Family (Everest 29), C Family (Everest) and Obverse (Classic) keyways are open.

## Cylinder category

### Full size

Pertaining to cylinders (including interchangeable cores), keys, and keyways based on the industry standard plug diameter of about 1/2". All Schlage cylinders except SFIC are full size.

### Small format interchangeable core (SFIC)

A core providing patented key control that is completely interchangeable with Best and its other clones, offered in Everest 29 R, Everest B Family restricted keyways. No Primus version exists.

Pins, springs, keys and keyways are based on a plug diameter smaller than the standard 1/2".

### Full Size Examples

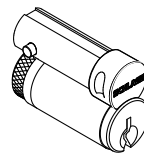

Full Size IC

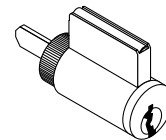

Key-in-Knob/Lever

### SFIC Example

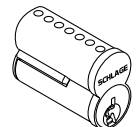

## Introduction



# Cylinders

## Modular cylinders

Introduced in July 2010, the Schlage modular cylinder provides easy convertibility between key-in-lever to mortise and rim cylinders. These benefits make Schlage cylinder inventory flexible, reduce the size and cost of inventory and customer lead time, and increase customer satisfaction. With a few modular components in stock, the cylinder type and finish required will always be on hand. The modular cylinder accepts a tailpiece or a mortise cam.

Product line availability: A, AL, B, CL, D, H, L, ND, S, S200, Kryptonite (PL, KS, KC), and Rim (standard and lockout). All competitive locks that accept Everest® Primus will also accept the modular cylinders.

### Key-in-knob to modular mortise or rim cylinder conversion

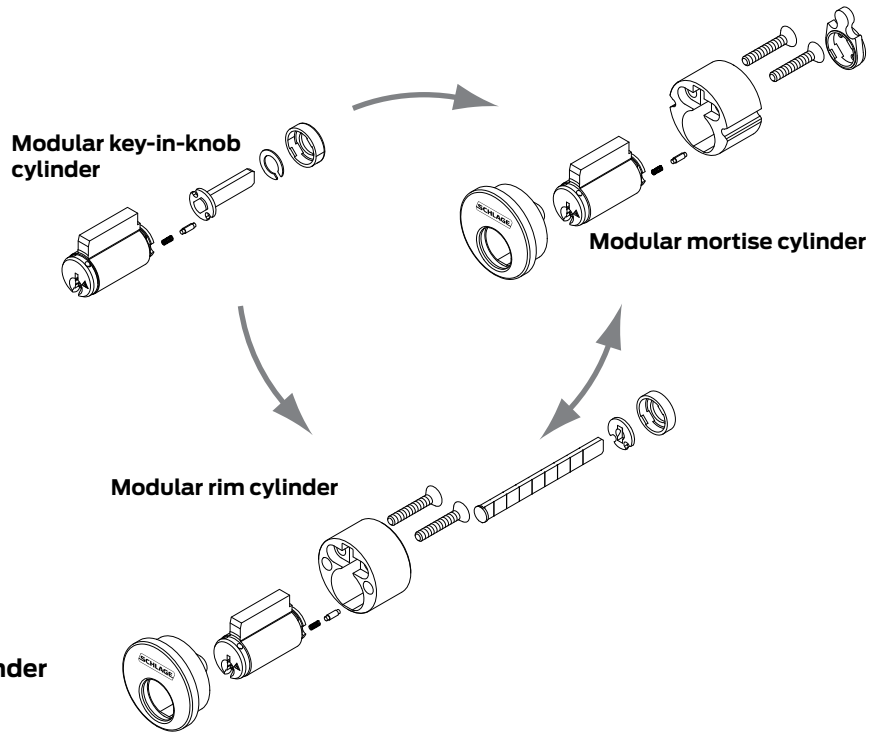
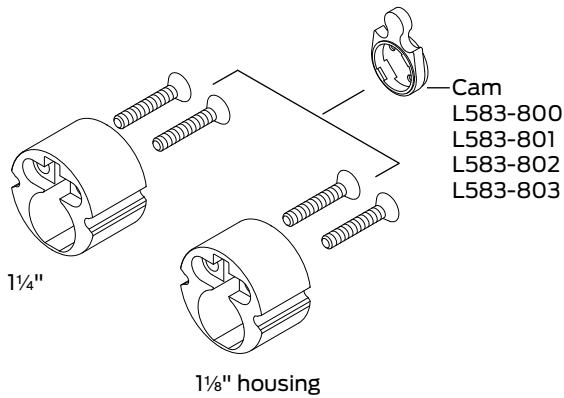

Modular housing interchangeability		
Housing		Cam
Part no.	Size	Part number
B520-721	1 1/8"	583-800
B520-722	1 1/4"	583-801

### Cam and tailpiece differences

Prior to July 2010, the cams and tailpieces used in the Primus/Primus XP cylinders were different than conventional cams and tailpieces because of the location of the sidebar and finger pins.

The illustrations below are rear views of the mortise cylinder as well as the key-in-knob/key-in-lever cylinders showing the differences in cap pin locations. All SL cylinders use the cap pin location in the illustration below.

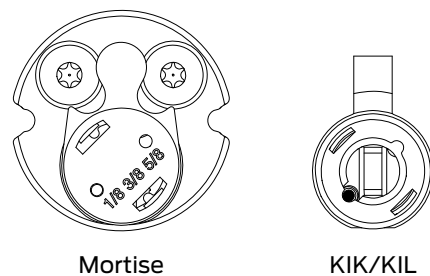

# Everest 29 SL

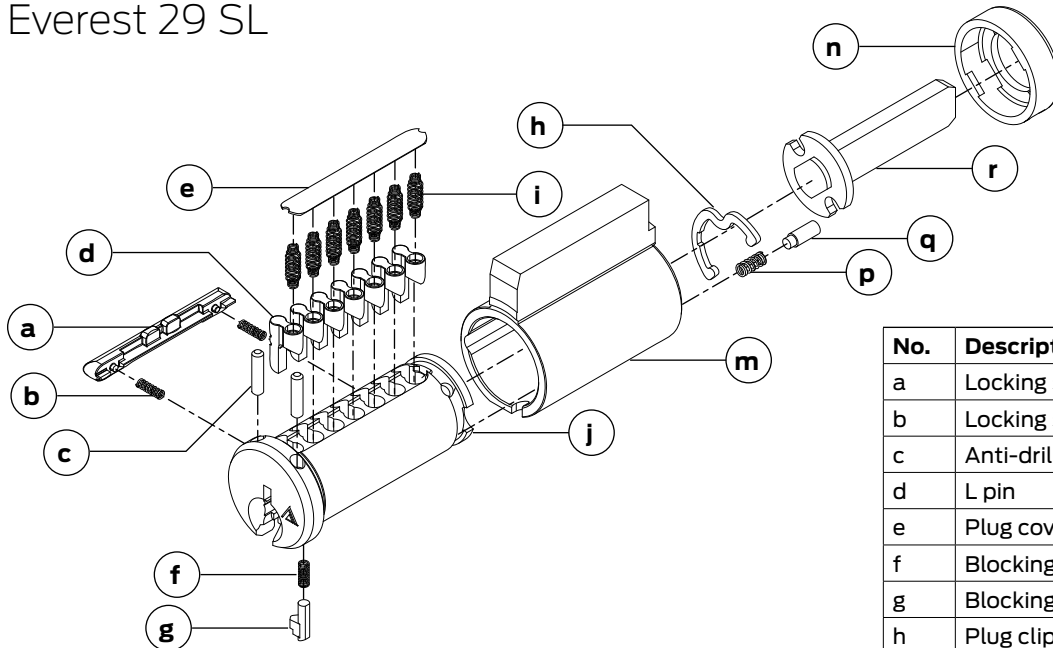

No.	Description	Part No.
a	Locking side bar	90-210
b	Locking sidebar spring	C604-472
c	Anti-drill pins	B505-451
d	L pin	See pg. 10
e	Plug cover	90-212
f	Blocking pin spring	C604-472
g	Blocking pin	34-950
h	Plug clip	C604-471
i	L pin spring	C603-951
j	Plug	33-213
m	Body	A508-660
n	End cap	90-211
p	End cap pin spring	C603-952
q	End cap pin	90-002
r	Tailpiece	See pgs. 12-15

### Order of installation

1. Place springs (b) on locking side bar (a).
2. Insert locking side bar into plug (j).
3. Insert L-pins (d) into plug (j).
4. Insert L-pin springs (i) into plug (j).
5. Install plug cover (e).
6. Insert check pin spring (f) into plug (j).
7. Insert check pin (g) into plug (j).
8. Insert set up key into plug (j).
9. Insert plug (j) into body (m).
10. Attach plug clip (h) to plug (j).
11. Install end cap pin spring (p) and end cap pin (q) into plug (j).
12. Place tail piece (r) onto back of body (m).
13. Snap end cap into place (n).

➔ Some parts listed may not be available for purchase separately.

### Operating principles

The SL cylinder was created to allow the incorporation of the Everest 29 SFIC 7 pin A2 pinning system into a full size cylinder format. The SL cylinder utilizes a unique l pin and locking sidebar design. When the l pin combination is properly aligned, the locking sidebar is allowed to move to free the cylinder plug to rotate.

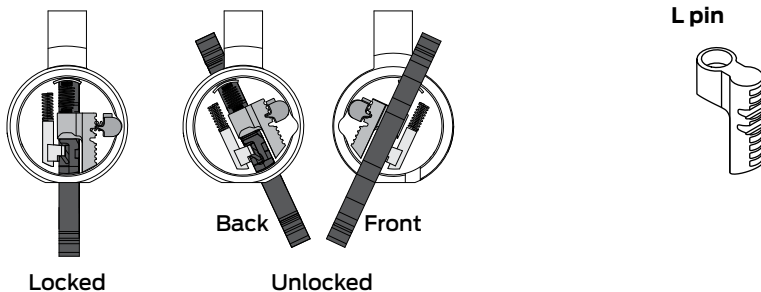

# Everest 29 SL Primus XP

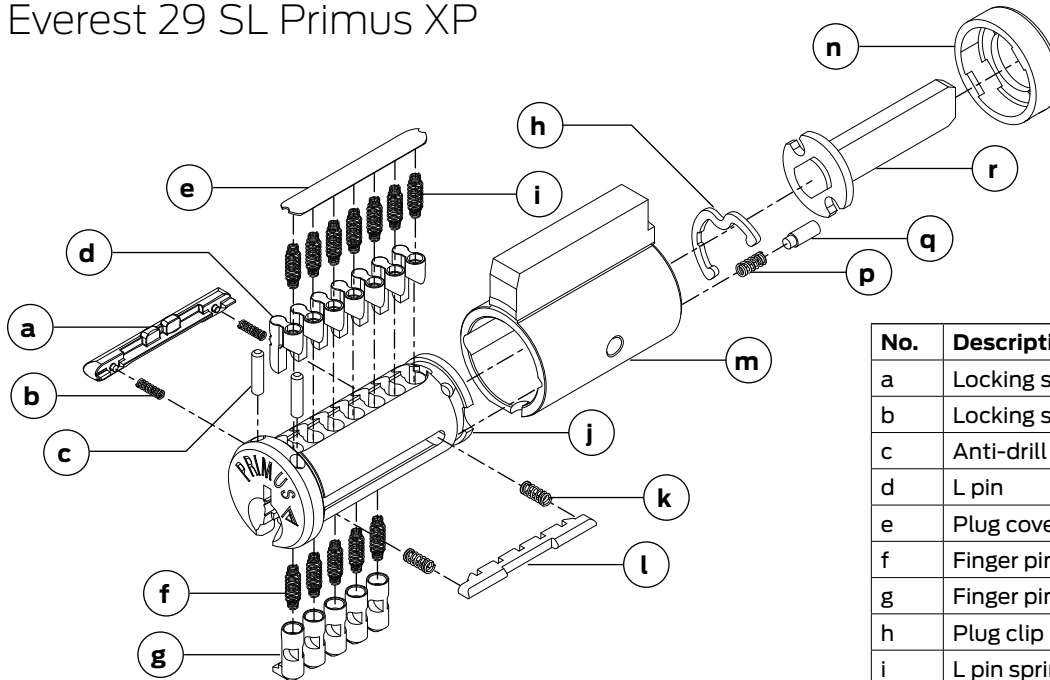

No.	Description	Part No.
a	Locking side bar	90-210
b	Locking sidebar spring	C604-472
c	Anti-drill pins	B505-451
d	L pin	See pg. 10
e	Plug cover	90-212
f	Finger pin spring	C603-951
g	Finger pin	See pg. 16
h	Plug clip	C604-471
i	L pin spring	C603-951
j	Plug	33-214
k	Primus side bar springs	C603-652
l	Primus side bar	C606-000
m	Body	A508-661
n	End cap	90-211
p	End cap pin spring	C603-952
q	End cap pin	90-002
r	Tailpiece	See pgs. 12-15

### Order of installation

1. Place springs (b) on locking side bar (a).
2. Insert locking side bar (a) into plug (j).
3. Insert L-pins (d).
4. Insert L-pin springs (i).
5. Install plug cover (e).
6. Insert finger pin springs (f) and finger pins (g) into plug (j).
7. Insert side bar springs (k) and side bar (l) into plug.
8. Insert set up key into plug (j).
9. Insert plug (j) into body (m).
10. Attach plug clip (h) to plug (j).
11. Install end cap pin spring (p) and end cap pin (q) into plug (j).
12. Place tail piece (r) onto back of body (m).
13. Snap end cap into place (n).

➔ Some parts listed may not be available for purchase separately.

### Operating principles

The Primus/Primus XP key has a secondary bitting on the side of the blade to accommodate the finger pins. When the key is inserted, each of the side bit cuts lifts the finger pin and rotates it so that the notches in the side bar align with the notches in the back of the finger pins.

When all notches on the side bar and back of the finger pins are aligned and the L pins are aligned at the locking side bar the plug is free to rotate.

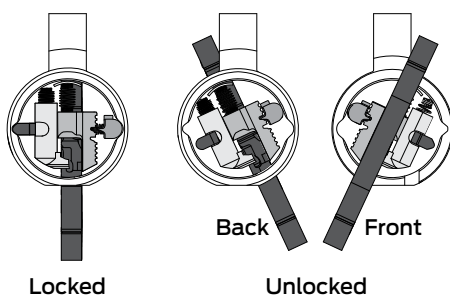

### Secondary side bitting

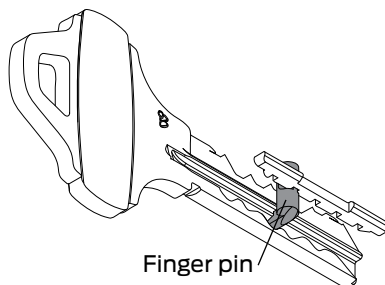

### Finger pins rotated

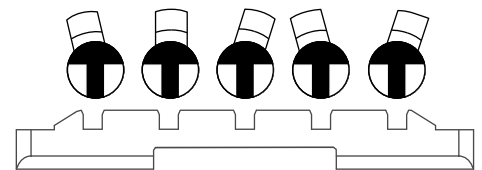

## Key-in-knob/key-in-lever cylinders

The part numbers for assembled Classic Primus and Everest Primus cylinders are the same, except for the keyway suffix. To order XP products, add the suffix “-XP” to the end of the complete cylinder number. (Example, “20-793-XP S123” is Everest 29 Primus XP cylinder with a S123 keyway.)

➔ Note: Everest & Primus cap pin positions are non-modular

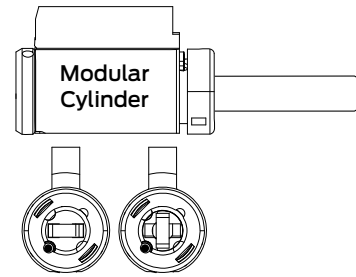

## Schlage lock sets

Schlage cylinders						
Series	Design	Cylinder mechanism	Complete cylinder	Tailpiece	Plug	Body
A, H	Except Orbit	Everest 29 SL	91-004	A301-337	33-213	A508-660
		Everest 29 SL Primus XP	91-704-XP		33-214	A508-661
A, H	Orbit	Everest 29 SL	91-005	A301-338	33-213	A508-660
		Everest 29 SL Primus XP	91-705-XP		33-214	A508-661
AL	All	Everest 29 SL	91-006	A700-031	33-213	A508-660
		Everest 29 SL Primus XP	91-706-XP		33-214	A508-661
D Knobs	All	Everest 29 SL	91-016	C603-524	33-213	A508-660
		Everest 29 SL Primus XP	91-714-XP		33-214	A508-661
ND Levers	All	Everest 29 SL	91-018	N523-022	33-213	A508-660
		Everest 29 SL Primus XP	91-718-XP		33-214	A508-661
S and S200	All	Everest 29 SL	91-007	S605-231	33-213	A508-660
		Everest 29 SL Primus XP	91-722-XP		33-214	A508-661

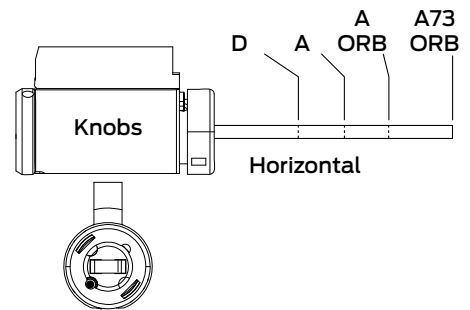
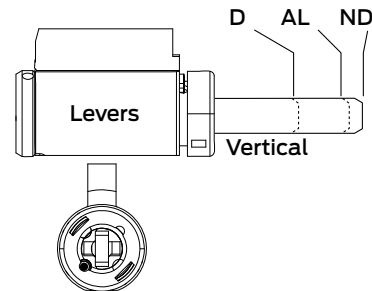
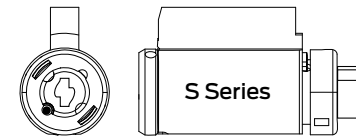

Note: For more information on modular cylinders, see page 9.

## Key-in-knob/key-in-lever competitive cylinders, Everest 29 Keyway

Corbin Russwin cylinders						
Side view	Lock series	Cylinder mechanism	Complete cylinder	Tailpiece	Plug	Body
	CL3300	Everest 29 SL	91-020	N523-022	33-213	A508-660
		Everest 29 SL Primus XP	91-717-XP		33-214	A508-661
	CL3400, CL3600	Everest 29 SL	91-027	A301-338	33-213	A508-660
		Everest 29 SL Primus XP	91-708-XP		33-214	A508-661

Sargent cylinders						
Side view	Lock series	Cylinder mechanism	Complete cylinder	Tailpiece	Plug	Body
	7L, 8L, 10 Line Levers	Everest 29 SL	91-042	C604-243	33-219	A508-660
		Everest 29 SL Primus XP	91-742-XP		33-214	A508-661

## Cylinders

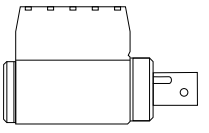
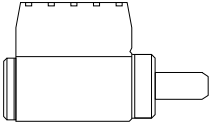
Sargent cylinders						
Side view	Lock series	Cylinder mechanism	Complete cylinder	Tailpiece	Plug	Body
	7, 8, 9 Line Knobs	Everest 29 SL	91-043	C303-437 Assembly with cap	33-219	A508-660
		Everest 29 SL Primus XP	91-743-XP		33-214	A508-661
	6 Line, Except B Knob	Everest 29 SL	91-045	C604-243	33-219	A508-660
		Everest 29 SL Primus XP	91-745-XP		33-214	A508-661

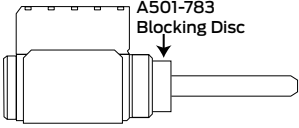
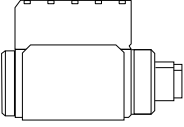
Yale cylinders						
Side view	Lock series	Cylinder mechanism	Complete cylinder	Tailpiece	Plug	Body
	5300LN, 5400LN Levers	Everest 29 SL	91-046	A301-043	33-219	A508-660
		Everest 29 SL Primus XP	91-744-XP		33-214	A508-661
	5300, 5400, 6200 Knobs	Everest 29 SL	91-044	B520-409	33-219	A508-660
		Everest 29 SL Primus XP	91-746-XP		33-214	A508-661

AD-Series key-in-lever cylinders						
AD-Series chassis	Lever style	Cylinder mechanism	Complete cylinder	Tailpiece	Plug	Body
CY	All	Everest 29 SL	91-017	C604-243	33-213	A508-660
		Everest 29 SL Primus XP	91-715-XP		33-214	A508-661
MS, MD	All	Everest 29 SL	91-019	23538085	33-213	A508-660
		Everest 29 SL Primus XP	91-721-XP		33-214	A508-661
993R, 993S, 993M	ATH, 8AT	Everest 29 SL	91-017	C604-243	33-213	A508-660
		Everest 29 SL Primus XP	91-715-XP		33-214	A508-661
	Except ATH, 8AT	Everest 29 SL	91-019	23538085	33-213	A508-660
		Everest 29 SL Primus XP	91-721-XP		33-214	A508-661

# Cylinders

## Deadlock cylinders

B600/700/800-Series Cylinder Reference Table							
Cylinder Mechanism	Function	Door Thickness	Cylinder Less housing	Keyway Type	Plug	Body	Tailpiece
Everest 29 SL	B660, B663	1 3/8" - 2 1/2"	91-032	Everest B and Everest 29 R	33-213	A508-660	B610-084
		B661, B664	1 3/8" - 2"		91-030	33-213	A508-660
	2" - 2 1/2"		91-031		33-213	A508-660	B610-083
	B662	1 3/8" - 2"	91-028		33-213	A508-660	B610-085
		2" - 2 1/2"	91-029		33-213	A508-660	B610-086
	Everest 29 SL Primus XP	B760-XP, B763-XP	1 3/8" - 2 1/2"		91-711-XP	33-214	A508-661
B761-XP, B764-XP			1 3/8" - 2"	91-709-XP	33-214	A508-661	B610-082
		2" - 2 1/2"	91-710-XP	33-214	A508-661	B610-083	
B762-XP		1 3/8" - 2"	91-712-XP	33-214	A508-661	B610-085	
		2" - 2 1/2"	91-713-XP	33-214	A508-661	B610-086	

## Cap pin location

### Everest 29 SL

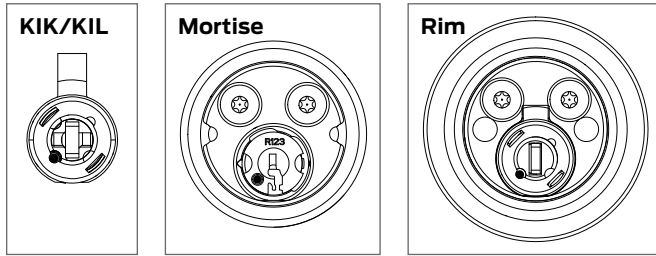

### Everest 29 SL Primus XP

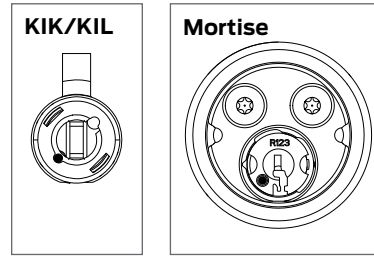

## Tailpiece orientation

### Cabinet locks

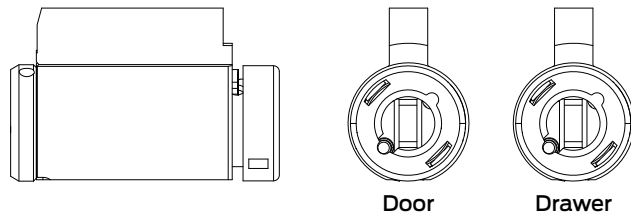

### Rim cylinders

Standard (non-IC)		
Description	Cylinder mechanism	Complete cylinders
Rim cylinder, vertical tailpiece	Standard	91-074
	Primus	91-774-XP
	Primus UL	91-574-XP
Rim cylinder, horizontal tailpiece	Standard	91-075
	Primus	91-775-XP
	Primus UL	91-575-XP

### Vertical Tailpiece

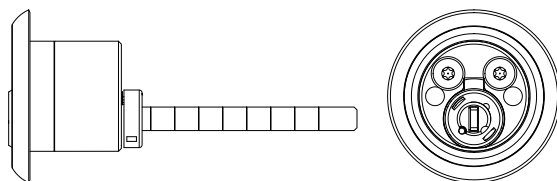



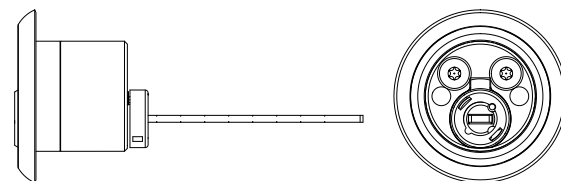





### Horizontal Tailpiece

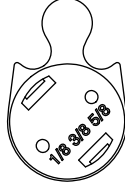

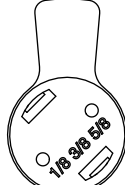
## Cylinders

### Mortise cylinders

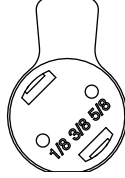





For modular SL cylinders introduced May 2016. Modular cylinder cams may be used with Everest and Primus key sections. Use appropriate cam for cylinder housing size.

Lock Models	1 $\frac{1}{8}$ " Housing	1 $\frac{1}{4}$ " Housing
Schlage L-Series (except L9060 outside)	L583-800 	L583-801 
Schlage L9060 outside and other straight cam applications	L583-802 	L583-803 
Adams Rite MS, 4500, 4700 Series Lori 4500 Corbin Russwin DL 3000	L583-773 	L583-774 
AR 4070 modular cam	B520-788 	B520-789 

→ Traditional cams are available as parts only and cannot be ordered with complete cylinders.

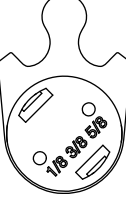
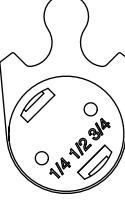
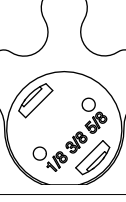
### Everest 29 SL cylinder cams to operate other manufacturers' locks

For modular cylinders introduced July 2010.

Sizes 1 $\frac{1}{8}$ "	Sizes 1 $\frac{1}{4}$ "	Lock models
B520-780 	B520-781 	Corbin Russwin® DL4000 Series (Old Corbin 420 and Russwin 1503)
B520-782 	B520-783 	Corbin Russwin® ML2200 Series (Old Corbin 7000-9000 and Russwin 4000-5000)  All functions except ML2255 and ML2242inside
B520-784 	B520-785 	Corbin Russwin® A65 ML2200 master ring deadbolt functions manufactured before 6/10/93 and old Russwin cast iron residential Locks
B520-779 	B520-787 	Yale® 2160, Arrow® #004, Sargent® 13-0660 (All functions except 16 inside and 50 outside)

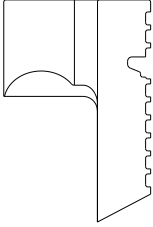
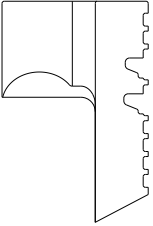

Type	Cam/Tailpiece	SL	SL Less Logo	SL Primus XP	SL Primus XP Less Logo
FSIC	--	91-161	91-162	91-861-XP	91-862-XP
FSIC/Mortise	L583-255	91-163	91-164	91-863-XP	91-864-XP
	L583-255 w/0.375" Blocking Ring	91-169		91-869-XP	
FSIC/Mortise	K510-680	91-165	91-166	91-865-XP	
FSIC/Mortise	K510-730	91-171		91-871-XP	
	L510-730 w/0.375" Blocking Ring	91-173		91-873-XP	
FSIC/Mortise	K510-711	91-172			
	L510-711 w/0.375" Blocking Ring	91-174		91-874-XP	
FSIC/Mortise	B520-378 w/0.375" Blocking Ring	91-175		91-875-XP	
FSIC/RIM	Convertible Tailpiece	91-170		91-870-XP	

## Pins, springs and sidebars

L-pins		
# of Notches	Notch Location	Part no.
	0	90-200
	1	90-201
	2	90-202
	3	90-203
	4	90-204
	5	90-205
	6	90-206
	7	90-207
	8	90-208
	9	90-209
	0, 2	90-200-2
	0, 4	90-200-4
	0, 6	90-200-6
	0, 8	90-200-8
	1, 3	90-201-3
	1, 5	90-201-5
	1, 7	90-201-7
	1, 9	90-201-9
	2, 4	90-202-4
	2, 6	90-202-6
	2, 8	90-202-8
	3, 5	90-203-5
	3, 7	90-203-7
	3, 9	90-203-9
	4, 6	90-204-6
	4, 8	90-204-8
	5, 7	90-205-7
	5, 9	90-205-9
6, 8	90-206-8	
7, 9	90-207-9	

Finger pins		
Size	Part no.	
1	34-001	
2	34-002	
3	34-003	
4	34-004	
5	34-005	
6	34-006	
7	34-007	

Other pins and springs		
Description	Part no.	
Spring, L pin and finger pin	C603-951	
Spring, end cap pin	C603-952	
Spring, locking side bar and blocking pin	C604-472	
Pin, blocking	34-950	
Pin, end cap	90-002	

Sidebars		
Description	Part no.	
Side bar, locking	90-210	
Side bar, Primus	C606-000	



## Rekeying

If the cylinder is outside of the lock:

1. First, remove the end cap and tailpiece or cam by depressing the end cap pin on the end of the plug, then rotate the end cap or cam counterclockwise, lifting it off from the end of the plug.
2. Next, remove the cylinder retaining clip by inserting the tip of a small flat-blade screwdriver into a notch in the clip designed to facilitate removal.
3. There are no top pins, so shimming the cylinder is unnecessary. Use a key to hold in the check pin and spring. The plug will slide out of the front of the body without rotating the plug. Hold on to the locking sidebar while removing the plug. Insert the plug into the plug fixture, then remove the plug cover by inserting the tip of a small flat-blade screwdriver into a small notch on either end of the plug cover. The L pins and springs are now accessible for rekeying the SL cylinder.
4. After the cylinder is repinned, press on a new plug cover using the crimping tool (40-296), then reassemble the cylinder.

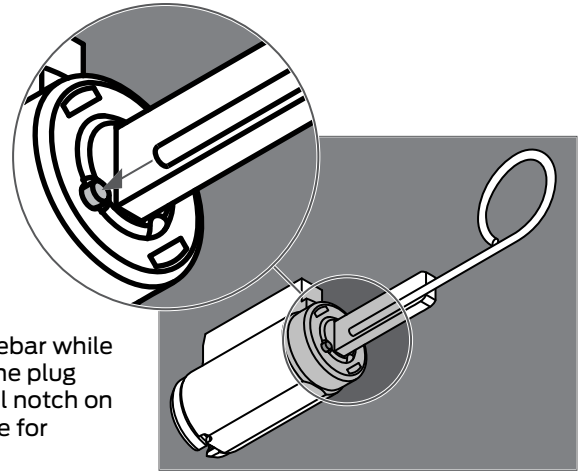

Fig. 4.1: Depressing the end cap pin

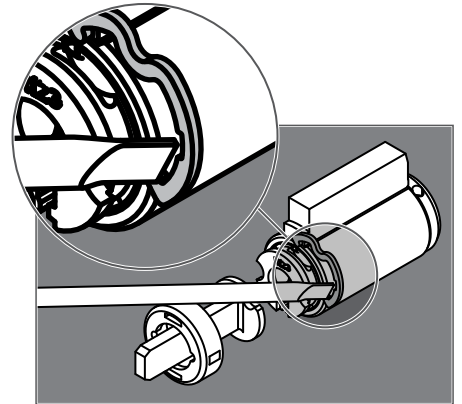

Fig. 4.2: Removing the cylinder retaining clip

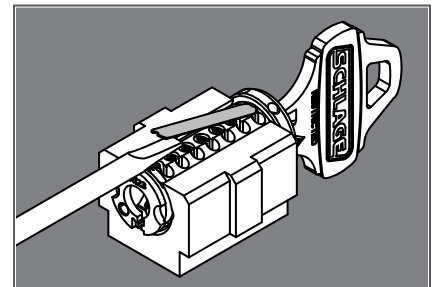

Fig. 4.3: Removing the plug cover

## How to pin SFIC vs. Everest 29 SL

### SFIC pinning

Pinning for a small format interchangeable core (SFIC) A2 key system is based on a 0.0125" increment. The core has two shear lines; all operating keys work at the operating shear line and only the control key works at the control shear line, which is 10 increments above the operating shear line. The operating keys operate the core, which in turn operates the lock. The control key only removes or installs the core.

In an SFIC A2 master key system, each pin chamber will typically have four pin segments, all of which must be calculated and all must add up to a total of 23. To start the calculations, the bitting of the operating keys, the great grand master (GGM) and the change key AA16, are used to determine the bottom pin and master pin. Then 10 is added to the control key bitting to calculate the build-up pin sizes. Finally, by adding the sizes of the bottom pin, master pin, and build-up pin together, the top pin size is calculated by what is needed to total 23.

Using the first pin chamber as an example, think of the numbers in order from the smallest to the largest, where the largest number will always be the control key bitting, because 10 is added to each number there. The three numbers used in the first pin chamber are 2, 8, and 14, plus the total must be 23. These numbers are used to calculate the bottom pin, master pin, build-up pin, and top pin. The smallest number, 2, is the size of the bottom pin. The next number to operate the core is 8, so the master pin size is added to the bottom pin to equal 8; the master pin is 6 (2+6=8). Now that the total in the core is 8, the build-up pin is added to 8 to equal 14, which will operate the core at the control shear line (8+6=14); the build-up pin is 6. Now that all the pins add to 14, the top pin is 9, because 14+9=23. The calculation process must be done for all 7 pin chambers.

Control key	4	1	3	2	5	3	1
GGM	2	9	7	4	5	3	1
AA16	8	1	9	0	3	1	7
Top pin							
Build-Up pin							
Master pin							
Bottom pin							

Fig. 4.4: SFIC Pinning chart

### Everest 29 SL pinning

No math is required and the control key has no function for SL cylinders. In the first pin chamber, the operating keys have a 2 and 8, therefore the L pin is 2-8. It's that simple!

Control key	4	1	3	2	5	3	1
GGM	2	9	7	4	5	3	1
AA16	8	1	9	0	3	1	7
Top pin	9	12	10	11	8	10	12
Build-Up pin	6	2	4	8	10	10	5
Master pin	6	8	2	4	2	2	6
Bottom pin	2	1	7	0	3	1	1

Fig. 4.5: SFIC Pinning

GGM	2	9	7	4	5	3	1
AA16	8	1	9	0	3	1	7
SL pin	2-8	1-9	7-9	0-4	3-5	1-3	1-7

Fig. 4.6: SL cylinder pinning (no math needed)

# Keys

## Key Bitting Specifications

Depths	
0 = .3187"	5 = .2562"
1 = .3062"	6 = .2437"
2 = .2937"	7 = .2312"
3 = .2812"	8 = .2187"
4 = .2687"	9 = .2062"

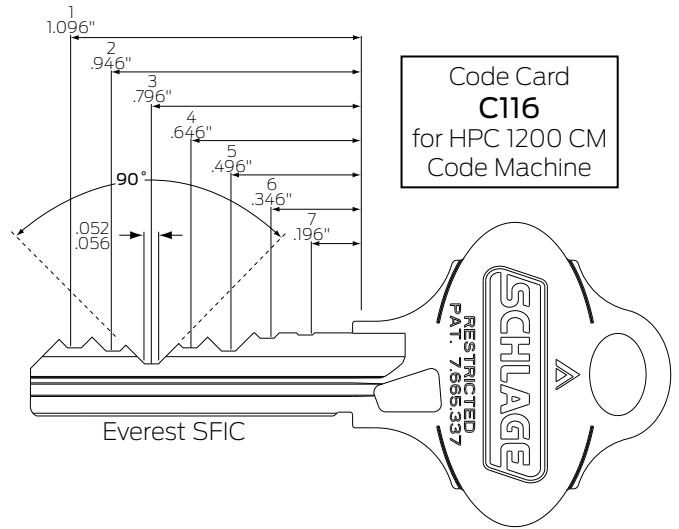

### Reading the L pin

The L-Pin is notched at heights corresponding to bitting depths in the A2 key system so that when a correctly combined key is inserted into the cylinder and rotated, the locking sidebar is able to cam in.

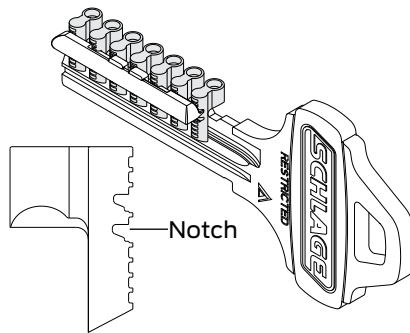

### Reading Primus/Primus XP finger pins

Learning to read finger pins is useful because pins can get spilled or mixed in with other size finger pins.

In 1998 the bottom of the finger pin was redesigned. This does not affect the functionality of the pins or the technique used for reading the pins.

#### 1. Determine the angle

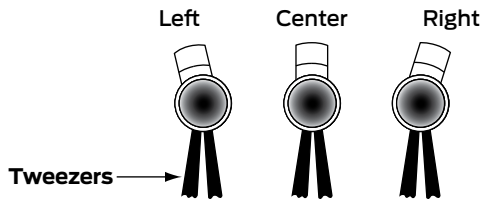

#### 3. Convert angle and depth to numbers

	Left	Center	Right
Deep	2	4	6
Shallow	1	3	5
Extra shallow			7

#### 2. Determine the depth

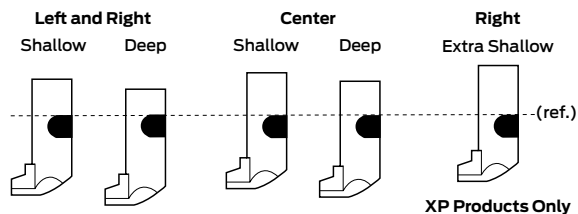

## Keys

### Reading keys

All keys will have exactly seven standard cuts, read tip to bow, and five side bit cuts, read from bow to tip.

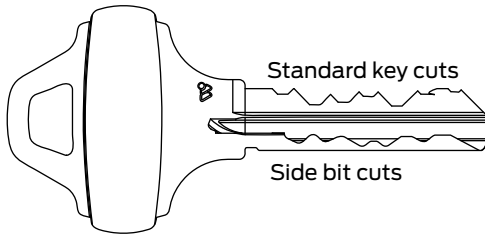

### Standard cuts

Standard key cuts should be read using the Schlage Key Gauge (40-128) starting at the tip of the key. Insert key into widest end and slide until key stops. The nearest number is the key cut depth.

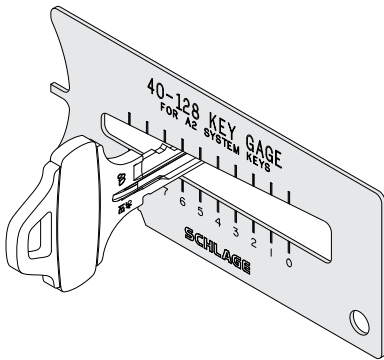

### Side bit cuts

There are six side bit cut possibilities for Primus and Everest Primus and seven side bit cut possibilities for Primus XP and Everest Primus XP.

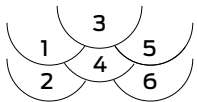

Primus® and Everest® Primus®

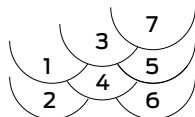





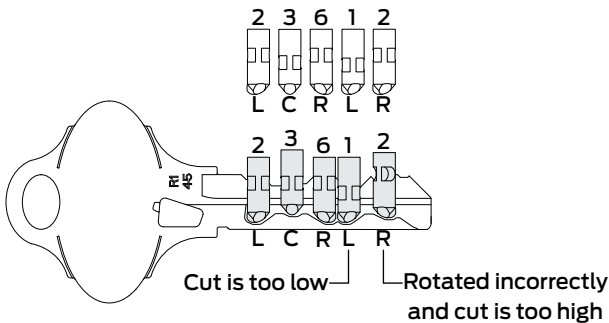
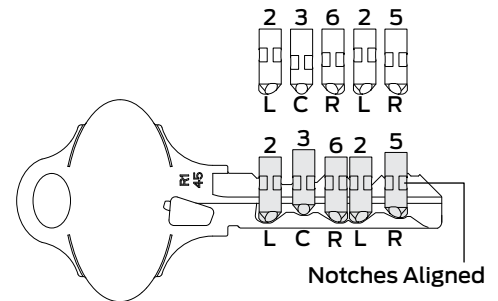



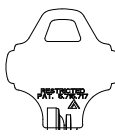
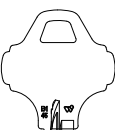
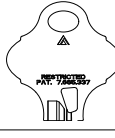





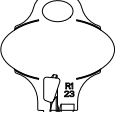

Primus® XP and Everest® Primus® XP

Each of the side cuts raise and swivel the finger pin in order to align the notch in the pin to the notch in the side bar. If a side cut is misread, the pin will not align with the side bar by being too high, too low or rotated in the wrong direction.



## Compatible keys

Key blanks			
Part no.	Description	Front	Back
35-021	Everest B, bow unembossed		
35-264	Everest R, bow unembossed		
35-421-XP	Everest, bow embossed		
35-427-XP	Everest, 7-pin FSIC, bow embossed		
35-422-XP	Everest, bow unembossed		
35-428-XP	Everest, 7-pin FSIC, bow unembossed		
35-423-XP	Everest 29, bow embossed		
35-431-XP	Everest 29, 7-pin FSIC, bow embossed		
35-424-XP	Everest 29, bow unembossed		
35-432-XP	Everest 29, 7-pin FSIC, bow unembossed		

Master keys	
Part no.	Description
49-021	Everest B, bow unembossed
49-264	Everest R, bow unembossed
49-421-XP	Everest, bow embossed
49-422-XP	Everest, bow unembossed
49-423-XP	Everest 29, bow embossed
49-424-XP	Everest 29, bow unembossed
49-425	Everest, 7-pin FSIC, bow embossed
49-426	Everest, 7-pin FSIC, bow unembossed
49-429	Everest 29, 7-pin FSIC, bow unembossed
49-430	Everest 29, 7-pin FSIC, bow unembossed
49-427-XP	Everest, 7-pin FSIC Primus XP, bow embossed
49-428-XP	Everest, 7-pin FSIC Primus XP, bow unembossed
49-431-XP	Everest 29, 7-pin FSIC Primus XP, bow embossed
49-432-XP	Everest 29, 7-pin FSIC Primus XP, bow unembossed

Cut keys	
Part no.	Description
48-021	Everest B, bow unembossed
48-264	Everest R, bow unembossed
48-400	Everest 29
48-401	Everest
48-421-XP	Everest, bow embossed
48-422-XP	Everest, bow unembossed
48-423-XP	Everest 29, bow embossed
48-424-XP	Everest 29, bow unembossed
48-425	Everest, 7-pin FSIC, bow embossed
48-426	Everest, 7-pin FSIC, bow unembossed
48-429	Everest 29, 7-pin FSIC, bow unembossed
48-430	Everest 29, 7-pin FSIC, bow unembossed
48-427-XP	Everest, 7-pin FSIC Primus XP, bow embossed
48-428-XP	Everest, 7-pin FSIC Primus XP, bow unembossed
48-431-XP	Everest 29, 7-pin FSIC Primus XP, bow embossed
48-432-XP	Everest 29, 7-pin FSIC Primus XP, bow unembossed

## Key control levels overview

Below is a chart that provides an overview and comparison of the different Key Control levels. In-depth information is covered in the pages following.

### Dealer controlled systems

Dealer controlled systems are sold and serviced by the locksmith or dealer who sold the system. End users must order keys and request servicing through the original dealer.

### End user exclusive systems

End User Exclusive Systems are sold directly to and controlled by the end user. The systems are generally sold to larger businesses or those that need a very high level of security. Side bit milling is exclusive to the end user based on either a random assignment, the first two digits of the zip code, time zone or on a nationwide basis.



**Classic Primus XP**

Ideal for existing key systems patent protected through 2024



**Everest 29 Primus XP**

Ideal for new key systems patent protected through 2029

	Dealer controlled system		End User Exclusive Systems	
<b>Level 1 XP</b>	<b>National non-exclusive</b> Stocked by distributors and resold to end users via commercial locksmiths; All Level 1 locksmiths have the same side bit millings.	<b>Typical applications</b> Strip mall shops Small businesses Upscale homes	<b>Consider Everest 29 open for commercial exclusivity</b>	
<b>Level 1+ XP</b>				
<b>Level 2 XP</b>	<b>Dealer exclusive</b> Owned & stocked by dealers; resold to end users. Keys bear unique Dealer ID based upon three digit zip-code exclusivity of side bit milling.	Small businesses Restaurants Doctor's offices	<b>Dealer Exclusive System</b> <b>Level 7 XP</b> Dealer exclusive Owned & stocked by dealers; resold to end users. Keys bear unique Dealer ID based upon three digit zip-code exclusivity of side bit milling.	
<b>Level 3 XP</b>	<b>Dealer exclusive</b> Dealers that sell directly to end users are eligible for side bit milling exclusivity. Exclusivity is for the dealer physical location time zone.	Office buildings Banks Private schools Healthcare residences	<b>Level 8 XP</b> Dealer exclusive Dealers that sell directly to end users are eligible for side bit milling exclusivity. Exclusivity is for the dealer physical location time zone.	
<b>Level 4 XP</b>			<b>End User Exclusive Systems</b> <b>Level 9 XP</b> End-user exclusive Exclusivity is based on random assignment, on the first 2 digits of the zip code, on time zone, or on a nationwide basis, depending on end user commitment.	
	<b>End user exclusive systems</b> <b>Level 3 XP</b> Exclusivity is based on either random assignment or on the first 2 digits of the zip code, depending on end user commitment.	Educational facilities Healthcare facilities Large office complexes Government buildings Detention centers Franchises	<b>Level 9 XP</b> End-user exclusive Exclusivity is based on random assignment, on the first 2 digits of the zip code, on time zone, or on a nationwide basis, depending on end user commitment.	
	<b>End user exclusive systems</b> <b>Level 4 XP</b> Exclusivity is based on either a time zone or nationwide basis, depending on end user commitment.			

## Everest 29 Primus XP Level 9

### Overview for end user

- Schlage's highest level of key control and exclusivity on Everest keyways.
- Level 9 is subdivided to be flexible for the amount of geographical exclusivity purchased.
- Side bit milling is assigned to the end user based on the exclusivity purchased. See level and commitments listed below.
- The end user has access to key blanks and cuts keys.
- The end user generates and maintains their own key system.
- Registration on Schlage's electronic validation tool (mycredentials.allegion.com) or a signed original Primus Face Sheet and signature card are required initially to set up End User Level systems
- Every order must be submitted through Schlage's electronic validation tool (mycredentials.allegion.com) or include a signed original Face Sheet which is closely checked for an authorized signature. No faxes or photocopies are acceptable due to the ease of forgery. The end user can get competitive bids and order End User Level material from any one of a large number of authorized dealers nationwide.

The degree of geographical exclusivity of end user side bitting is determined with the initial order as listed below.

#### Level 9U (universal)

**Fewer than 60 Cylinders.** Schlage randomly assigns a side bitting from a small pool of combinations which may be repeated locally. There are no guarantees of geographical exclusivity.

#### Level 9G (geographical)

**More than 60 cylinders.** Schlage assigns an exclusive side bitting based on the first two digits of the end user's zip code.

#### Level 9Z (time zone)

**Minimum of 2000 cylinders over two years or pay a fee.**

The end user buys exclusivity of one side bitting within a time zone and country.

#### Level 9N (nationwide)

**Minimum of 4000 cylinders over two years or pay a fee.**

The end user buys nationwide exclusivity of one side bitting.

### Overview for locksmith or security dealer

- These levels are for end users who want to cut their own keys and/or generate their own key system.
- Dealers already selling Level 2 or 8 are authorized to sell Level 9 products.
- Level 1+ and 7 dealers must sign an additional key control contract, but no buy-in is required.
- The degree of geographical exclusivity is determined by the end user's commitment to cylinder volume and separate exclusivity purchases.
- No ID cards are issued at this level.
- All authorization is done with the Primus Face Sheet and Signature Card.
- Schlage requires orders to be completed online using e-validation or by original signature on a Primus Face Sheet to process each order.
- Unless Level 9 side bitting is bought outright, Schlage reviews cylinder volume annually and if the contractual commitment is not met, has the option to lower the project to Level 9U and place the side bitting into the Level 9U pool for other end users.

### Keyways and keying options

The geographical exclusivity of these levels makes it impractical to illustrate or list all the side bittings. New ones are issued every day around the country.

- Dealers can stock bulk-pack sub-assembled cylinders.
- All cylinders, key and blanks are shipped to the end user's designated location.
- Multi-section keys are available for this level, to accommodate larger systems.
- The last cut of the side bittings at this level is normally shallow (1, 3 or 5) to raise the check pin of conventional Everest cylinders. However, side bittings with a deep last cut are also available at Level 9, provided that the key system will never incorporate conventional cylinders.

## Key control procedures: end user controlled systems

### Electronic Validation

End user's restricted product authorization can now be completed in a hassle-free way. By visiting [mycredentials.allegion.com](http://mycredentials.allegion.com), authorization orders can be processed without mailing anything in. End users can manage who can generate restricted product authorizations, as well as view all order history.

### Signature verification

Authorization for the end user levels is performed at the Schlage Key Control Center. The dealer is responsible for submitting the end user's signed forms to Schlage with each order.

### Primus signature card

The Primus Signature Card or electronic validation should be used to register each project and its authorized signatories with the factory.

The dealer should complete the form with the end user (job) name, street address and zip code. The zip code is used to maintain the varying degrees of geographical exclusivity offered at the end user levels.

There is space for up to five authorized signatures on the signature card. All signatures will have equal authority to order locks, keys, key blanks and cylinders unless otherwise noted. The signature at the top of the list has authority to add and delete signatures from the card, so it is important that the appropriate person is the top signer.

### Primus face sheet form

The Primus Face Sheet form is located online, or from customer service and is required for every Primus or Primus XP factory order.

**Levels 3, 4 and 9 are the highest levels of key control. For this reason, no faxed or photocopied signatures will be accepted by the Primus Key Control Center.**

It is permissible to fax or photocopy the blank forms in order to speed up the authorization process when the end user has no blank forms. However, once the page is signed it becomes an original and cannot be faxed or photocopied, then submitted for an order.

It is also possible to order a supply of blank forms at no charge using the following form numbers:

Signature Card	MS-E130
Face Sheet	MS-E120



# Three parts to key control

How do you account for issued keys? How do you know who has keys to areas of your building or campus? Facilities with proper key control procedures in place know the answers to these questions.

To help facility and security personnel to know who has access to the mechanical locks in their buildings, Schlage offers a three-part solution.

### 1. Key issue policies

Without a sensible key control policy backed by top management, security can deteriorate quickly. The key control policy should specifically define who may authorize keys to be cut.

Issuing master and grand master keys must be done based on actual need. After all, it does little good to prevent keys from being duplicated externally if many “legitimate” copies of the top master key are issued, increasing risk of loss or theft.

Consider the following ideas which may be utilized (and modified as needed) if deemed appropriate for your facility:

- Establish suitable management levels (department head, shop foreman, etc.) to authorize keys to be cut or issued to employees. Control high level access by requiring higher level approval for master and grand master keys.
- Collect a deposit for all keys issued.
- Require employees to sign a receipt stating that his/her final paycheck will be withheld until all keys are returned. This requires coordination with the Human Resources or Accounting Department.
- Have the key holder or the department manager sign a receipt making them responsible for the cost of rekeying any areas operated by the lost or stolen key.
- Serial number all keys to track multiple copies of the same key issued to different persons. This allows the key control center to trace any key to the rightful key holder.
- Include language on a key receipt that forbids lending of keys to other employees.
- Conduct periodic spot checks to make sure employees have their issued keys.
- Do not store quantities of unused master keys. Destroy them or provide secure storage if necessary.
- Trades, contractors, and maintenance personnel should turn in their master keys at the end of their shifts and pick them up again the next day.
- Enforce adherence to policies with consequences.

### 2. Track issued keys with SiteMaster 200

Implementing a system to track each and every issued key is critical to provide immediate information about who has access to any given area at any given time. Schlage SiteMaster 200 helps provide this critical information.

SiteMaster 200 has fields for key holder name, key symbol (code), serial number of key, door name, number, etc. Once the data has been entered you can sort it in a variety of ways to produce reports or simply look up an individual person, key, door, etc.

To be effective, one person should be designated responsible for maintaining the database, with backup personnel designated as necessary. Too many people with access to the database can lead to a breakdown in the integrity of the information.

### 3. Use patented keys

Be sure Parts 1 and 2 are in place.

Install Primus or Everest Primus patented keyways and you can be reasonably sure that your keys won't be copied. It would be difficult, time consuming, and a violation of federal patent law to make an unauthorized copy of a Primus XP or Everest Primus XP key. A person who makes an unauthorized Primus XP or Everest Primus XP key could be subjected to legal action from Schlage.



## Keys

# Tools, kits and accessories

## Pin kits

Primus® pin kit 40-070		
Part no.	Description	Qty
C603-951	Fingerpin springs	100
34-001	#1 Fingerpins	25
34-002	#2 Fingerpins	25
34-003	#3 Fingerpins	25
34-004	#4 Fingerpins	25
34-005	#5 Fingerpins	25
34-006	#6 Fingerpins	25
34-058	#7 Fingerpins	25
C603-952	Sidebar springs	30
C606-000	Sidebars	10
40-066	Plug holder	1
M204-205	Pin kit case	1

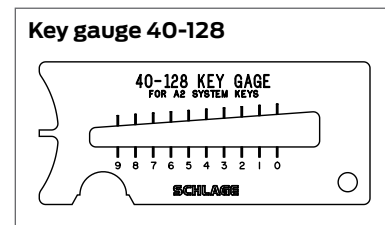
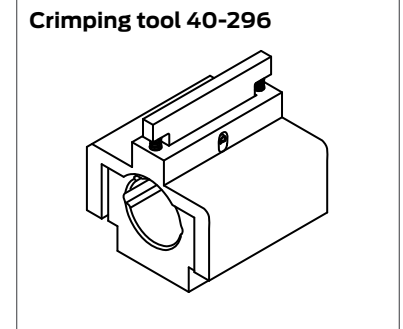
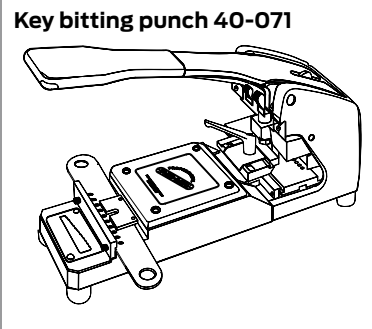

Everest SL pin kit 40-247								
Part no.	Description	Qty	Part no.	Description	Qty	Part no.	Description	Qty
40-247M	Assembled kit	1	90-207	#7 L-pin	25	90-203-5	#3 & #5 L-pin	25
C603-951	Finger pin spring	100	90-208	#8 L-pin	25	90-203-7	#3 & #7 L-pin	25
90-212	Plug cover	20	90-209	#9 L-pin	25	90-203-9	#3 & #9 L-pin	25
C604-472	Sidebar spring	60	90-200-2	#0 & #2 L-pin	25	90-205-7	#5 & #7 L-pin	25
90-210	SL sidebar	20	90-200-4	#0 & #4 L-pin	25	90-205-9	#5 & #9 L-pin	25
90-211	End cap	10	90-200-6	#0 & #6 L-pin	25	90-207-9	#7 & #9 L-Pin	25
90-002	End cap pin	40	90-200-8	#0 & #8 L-pin	25	M204-200	Tweezers	1
C603-952	End cap pin spring	40	90-202-4	#2 & #4 L-pin	25	40-296	Crimping tool	1
C604-471	Retaining clip	20	90-202-6	#2 & #6 L-pin	25	M504-412	Key gauge	1
34-950	Check pin	20	90-202-8	#2 & #8 L-pin	25			
90-200	#0 L-pin	25	90-204-6	#4 & #6 L-pin	25			
90-201	#1 L-pin	25	90-204-8	#4 & #8 L-pin	25			
90-202	#2 L-pin	25	90-206-8	#6 & #8 L-pin	25			
90-203	#3 L-pin	25	90-201-3	#1 & #3 L-pin	25			
90-204	#4 L-pin	25	90-201-5	#1 & #5 L-pin	25			
90-205	#5 L-pin	25	90-201-7	#1 & #7 L-pin	25			
90-206	#6 L-pin	25	90-201-9	#1 & #9 L-pin	25			

## Bulk packs

**10-Piece Bulk Packs for Unassembled Everest and Everest 29 SL Cylinders**

Cylinder is shipped unassembled in the box.

Does not include l pins, l pin springs, Primus finger pins, Primus finger pin springs or key blanks.

<b>Key-in-lever</b>					
<b>Cylinder mechanism</b>	<b>Keyway</b>	<b>Part no.</b>	<b>Contents</b>		
			<b>Qty.</b>	<b>Part no.</b>	<b>Description</b>
SL Cylinder	Everest B or Everest 29 R Keyway Families	91-451	10	33-213	Plug
			10	A508-660	Body
			10	C604-471	Retaining Clip
			10	90-210	Locking Sidebar for SL
			20	C604-472	SL Sidebar Springs
			10	34-950	R/B Everest Check Pin
			10	C504-116	R/B Everest Check Pin Spring
			10	90-212	SL Plug cover
			10	90-211	End Cap for SL Cylinders
			10	90-002	SL End Cap Pin
			10	C603-952	SL End Cap Spring
SL Primus XP	Everest B or Everest 29 R Keyway Families	91-551	10	33-214	Plug for SL Primus XP
			10	A508-661	SL Primus XP Body
			10	C604-471	Retaining Clip
			10	90-210	Locking Sidebar for SL
			20	C604-472	SL Sidebar Springs
			10	C606-000	Primus Sidebar
			20	C603-952	Primus Side Bar Springs
			10	90-212	SL Plug cover
			10	90-211	End Cap for SL Cylinders
			10	90-002	SL End Cap Pin
			10	C603-952	SL End Cap Spring

## Tools, kits and accessories

<b>Mortise</b>					
<b>Cylinder mechanism</b>	<b>Keyway</b>	<b>Part no.</b>	<b>Contents</b>		
			<b>Qty.</b>	<b>Part no.</b>	<b>Description</b>
SL Cylinder	Everest B or Everest 29 R Keyway Families	91-452*	10	33-213	Plug
			10	A508-660	Body
			10	C604-471	Retaining Clip
			10	90-210	Locking Sidebar for SL
			20	C604-472	SL Sidebar Springs
			10	34-950	R/B Everest Check Pin
			10	C504-116	R/B Everest Check Pin Spring
			10	90-212	SL Plug cover
			10	K110-480	Front housing
			10	B520-722	Back housing (114)
			10	B520-721	Back housing (118)
			10	B520-693	Screws
			10	90-002	SL End Cap Pin
			10	C603-952	SL End Cap Spring
SL Primus XP	Everest B or Everest 29 R Keyway Families	91-552*	10	33-214	Plug for SL Primus XP
			10	A508-661	SL Primus XP Body
			10	C604-471	Retaining Clip
			10	90-210	Locking Sidebar for SL
			20	C604-472	SL Sidebar Springs
			10	C606-000	Primus Sidebar
			20	C603-952	Primus Side Bar Springs
			10	90-212	SL Plug cover
			10	K110-480	Front housing
			10	B520-722	Back housing (114)
			10	B520-721	Back housing (118)
			10	B520-693	Screws
			10	90-002	SL End Cap Pin
			10	C603-952	SL End Cap Spring

\* See **Mortise cylinders** on page 15 for available cams. Cams and collars sold separately.

Tools, kits and accessories

Rim					
Cylinder mechanism	Keyway	Part no.	Contents		
			Qty.	Part no.	Description
SL Cylinder	Everest B or Everest 29 R Keyway Families	91-453	10	33-213	Plug
			10	A508-660	Body
			10	C604-471	Retaining Clip
			10	90-210	Locking Sidebar for SL
			20	C604-472	SL Sidebar Springs
			10	34-950	R/B Everest Check Pin
			10	C504-116	R/B Everest Check Pin Spring
			10	90-212	SL Plug cover
			10	K110-480	Front housing
			10	B520-727	Back housing
			10	B520-693	Screws
			10	B502-310	Driver
			10	B502-899	Tailpiece
			10	90-211	End Cap for SL Cylinders
			10	90-002	SL End Cap Pin
10	C603-952	SL End Cap Spring			
SL Primus XP	Everest B or Everest 29 R Keyway Families	99-553	10	33-214	Plug for SL Primus XP
			10	A508-661	SL Primus XP Body
			10	C604-471	Retaining Clip
			10	90-210	Locking Sidebar for SL
			20	C604-472	SL Sidebar Springs
			10	C606-000	Primus Sidebar
			20	C603-952	Primus Side Bar Springs
			10	90-212	SL Plug cover
			10	K110-480	Front housing
			10	B520-727	Back housing
			10	B520-693	Screws
			10	B502-310	Driver
			10	B502-899	Tailpiece
			10	90-211	End Cap for SL Cylinders
			10	90-002	SL End Cap Pin
10	C603-952	SL End Cap Spring			

# Troubleshooting

Problem	Solution
Key won't fit into plug or only goes in part way.	A, B, C, D, E, F, G, H
SL sidebar will not fit into plug.	I, J
Sidebar cannot be pushed inward so it is flush with the plug.	I, J, K, L, M, N, O, P, Q, R, S, T, U
Key will not turn when plug is installed in housing.	I, J, K, L, M, N, O, P, Q, R, S, T, U, V, W
Key difficult to turn or key "catches" when being turned.	W, X, Y, Z, AA
Key can't be removed after plug is installed in housing.	BB, CC
Key is difficult to insert or remove.	DD
Plug retaining clip falls off.	EE, FF
No key or unknown combination.	GG
End cap loosens and falls off.	HH
L-pins not dropping down completely into shell.	II
Check pin falls out during assembly and pinning.	JJ

	Cause	Solution
A	Bent key.	Examine key and straighten or re-cut if necessary.
B	Wrong key blank used.	Check keyway number on back of plug and keyway number stamped on the shoulder of the key and make sure they match.
C	Keyway damaged or distorted.	Check front of keyway for distorted edges that extend into keyway and examine front of keyway for signs of force or abuse.
D	Key is upside down.	Reverse key and try inserting again.
E	Foreign object lodged inside keyway.	Use a broken key extractor, or small forceps to remove object.
F	Springs are the wrong type.	Check for proper spring type (length, diameter & tension) and reinsert.
G	Super glue inside lock.	Try applying heat to crystalize glue or use solvent such as Toluene or products such as Goof Off Super Glue remover which are specifically formulated to dissolve Super glue. Caution, some chemicals are flammable and should not be used in the presence of heat or flame. High heat may affect the spring tension or damage the lock beyond repair. Some chemicals may dissolve the coating used to protect the lock finish. In severe cases cylinder will need to be replaced.
H	Burrs, hooks or incorrect angle on key bittings.	Compare key with factory original to determine if slope is correct and examine for excessive burrs that may be produced by a dull key machine cutting wheel. Buff the key using a wire wheel or recut the key using a Schlage Blue punch machine or a code machine or order a factory original key from your retail locksmith or Schlage distributor.
I	Sidebar is installed backward.	Look for two small tabs on sidebar and make sure they point toward the top of the plug. If sidebar is being installed in an Everest SL Primus cylinder, make sure the SL sidebar is being installed in the plug cutout at the 3 o'clock position as viewed from the front of the cylinder body.
J	Sidebar springs have tipped or moved out of position and are preventing sidebar from moving inward.	Remove sidebar and springs and reinstall springs and sidebar. A security Torx driver and magnetic holder may be useful in positioning springs correctly. Make sure springs are fully seated on sidebar posts before inserting sidebar into plug.
K	No key is inserted or an incorrect key has been inserted.	Check that the correct key is being used.
L	Key may be excessively worn and no longer meets factory specifications.	Measure bittings using dial calipers and compare with key dimensions listed in the cylinder service manual. Recut key using a Schlage blue punch machine, a code machine or order a new factory original key from your retail locksmith or Schlage distributor.
M	Key may be a multi-generation duplicate of a duplicate that no longer meets factory specifications.	Measure bittings using dial calipers and compare with key dimensions listed in the service manual. Recut key using a Schlage blue punch machine, a code machine or order a new factory original key from your retail locksmith or Schlage distributor.
N	Wrong L-pins were inserted or pins may have gotten mixed up inside pin kit.	Check combination on bitting list and insert new L-pins as necessary.

## Troubleshooting

	Cause	Solution
O	Pinning chart was read incorrectly or cylinder was pinned from bow to tip by mistake.	Make sure the cylinder is pinned from tip to bow. Replace pins in proper order.
P	Key was cut incorrectly.	If using a bitting list and the Schlage blue punch or code machine, verify the correct numbers were read from the bitting list and set properly on the key machine. Verify the bitting numbers were referenced from tip to bow.
Q	Key machine is out of adjustment and is not cutting keys accurately.	Use dial calipers to measure depths of key bittings and compare them with dimensions for key bittings listed in cylinder service manual. Readjust key machine or, if using the Schlage blue punch machine, contact Schlage tech services @ 877-671-7011 for information on how to return the machine for servicing and adjustment.
R	Old style top jaw being used on Schlage blue punch machine.	Check service manual for information on identifying jaw types and for instructions on jaw replacement. Contact Schlage tech services @ 877-671-7011 for information on how to order a new top jaw.
S	Die carriage on Schlage blue punch machine was not pushed fully to the right prior to inserting the key into the key.	Push die carriage fully to the right, insert new key blank and cut a brand new key. Do not attempt to recut the existing key.
T	Top jaw of Schlage blue punch machine was not properly engaged and seated in the grooves of the key section.	Refer to illustrations in the Schlage cylinder service manual for tips on how to properly position top jaw.
U	Key tipped or was not properly clamped in key machine vise.	Make sure key is straight and properly clamped in key machine jaws. A special jaw or adapter may be required for machines not produced by Schlage. Contact the manufacturer of the key machine or Schlage tech support @ 877-671-7011 for more information.
V	Missing or broken L-pin springs.	Remove plug from body, then remove plug cap and inspect for missing or broken L-pin springs. Replace springs and plug cap as necessary.
W	Plug cap not fully seated or not sufficiently flattened with staking tool.	Examine cap for signs of rubbing and flatten using staking tool.
X	Dust, dirt, or foreign material inside body.	Clean lock with a solvent such as electrical contact cleaner, blow out with compressed air and lubricate the cylinder with a factory recommended lubricant. In severe cases the plug may need to be removed from the body.
Y	Lack of lubrication or incorrect lubrication used.	Clean lock with a solvent such as electrical contact cleaner, blow out with compressed air and lubricate the cylinder with a factory recommended lubricant. The factory uses Interflon Fin Lube TF. Other lubricants to consider include: powdered graphite, Lock Saver®, Houdini, Lab Lube or Tri-Flow®.
Z	L-pin springs not installed completely under plug cap.	Plug cap may have been installed over the springs incorrectly. Remove plug from body and check to see if any L-pin springs stick out above plug cap. Remove plug cap, install new cap over top of springs and use staking tool to flatten plug cap to secure it in place.
AA	Wrong Everest SL sidebar spring used.	The Everest SL locking sidebar uses a different spring than the Primus sidebar. Be sure to use spring number C604-472. Replace as required.
BB	Plug was installed into body backward.	As viewed from the front of the cylinder, the sidebar slot should be positioned at the 9 o'clock position. The plug should be inserted from the front of the body. The front of the body has a slight bevel on the front edge of the tower. The back of the body has a notch in the bible. Remove the tailpiece, end cap and plug clip and reinstall the plug into the front end of the body.
CC	Too much lubricant was used (especially powdered graphite) and is packed inside locking sidebar slot thus preventing sidebar from moving outward to allow pins to move freely.	Clean cylinder with a solvent such as electrical contact cleaner, blow out with compressed air and lubricate the cylinder with a factory recommended lubricant. In severe cases the plug may need to be removed from the body for a more thorough cleaning.
DD	L-pin springs are incorrect.	The L-pins require spring part number C603-951. These are the same springs used for the Primus finger pins.
EE	Plug clip may have gotten bent when it was removed.	Replace with a brand new clip.
FF	Plug clip may be installed incorrectly.	Make sure long arc of clip is facing toward the top of the plug and the tab on both ends of the clip are fully inserted into the holes in the plug.
GG	Cylinder needs to be rekeyed..	<b>See Rekeying on page 17 for more information.</b>



## Troubleshooting

	<b>Cause</b>	<b>Solution</b>
HH	Wrong cap pin or cap pin spring was used.	The Everest SL cylinders uses a different cap pin and cap pin spring than other types of Schlage key-in-lever cylinders. Make sure cap pin number 90-002 and cap pin spring number C603-952 was used. Replace as needed.
II	Small burrs from manufacturing process may be preventing free movement of pins.	Press down on pins with small pointed tool (such as Schlage ND-series pin wrench) to get them to seat fully.
JJ	Set up key not being used.	After check pin spring and check pin have been inserted, insert a set up key into plug to hold check pin in place.

# Interpreting box labels

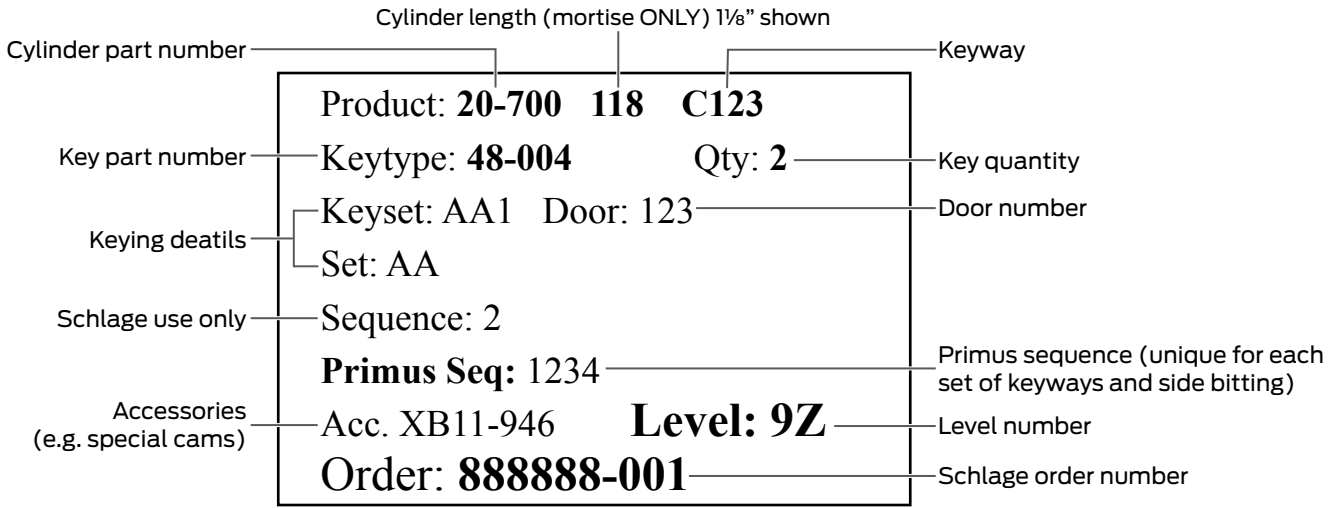



## About Allegion™

Allegion (NYSE: ALLE) is a global pioneer in safety and security, with leading brands like CISA®, Interflex®, LCN®, Schlage® and Von Duprin®. Focusing on security around the door and adjacent areas, Allegion produces a range of solutions for homes, businesses, schools and other institutions. Allegion is a \$2 billion company, with products sold in almost 130 countries.

For more, visit [www.allegion.com](http://www.allegion.com).

*aptiQ* ■ LCN ■ **SCHLAGE** ■ STEELCRAFT ■ VON DUPRIN