



SCHLAGE

Primus®

Primus, Primus XP, Everest™ Primus,
Everest Primus XP, Everest 29™ Primus,
Everest 29 Primus XP

Service manual



Contents

- 5 Introduction
- 5 Key systems
- 7 Terminology
 - 7 Keyways
 - 7 Cylinder mechanisms
 - 7 Key control
 - 7 Cylinder category
- 8 Construction and operating principles
- 9 Modular cylinders
 - 9 Key-in-knob to modular mortise or rim cylinder conversion
- 10 Cam and tailpiece differences
 - 10 Traditional cylinders (prior to april 2010)
 - 10 Modular cylinders
 - 10 Full size interchangeable core (FSIC)
 - 10 UL437
- 11 Lockout cylinder
 - 11 Pinning rules
 - 11 How the lockout cylinder works
- 12 Key bitting specifications
 - 12 Pins and springs
 - 13 Reading keys
 - 13 Reading side pins
- 14 Key control levels overview
 - 14 Dealer controlled systems
 - 14 End user exclusive systems
 - 15 Primus and Primus XP level 1
 - 16 Primus and Primus XP level 1+
 - 17 Primus and Primus XP Level 2
 - 18 Primus and Primus XP Level 3 and 4
 - 19 Everest Primus and Everest Primus XP level 7
 - 20 Everest Primus and Everest Primus XP level 8
 - 21 Everest Primus and Everest Primus XP Level 9
- 22 Key control procedures: dealer controlled systems
 - 22 Identification cards
 - 22 Restricted key order form
 - 22 Primus control register MS-E160
 - 22 Issuing ID cards
 - 22 Managing lost, stolen or invalidated cards
 - 22 Managing key blank inventory
- 23 Key control procedures: end user controlled systems
 - 23 Signature verification
 - 23 Primus signature card
 - 23 Primus face sheet form
- 24 Classic Primus and Classic Primus XP keyways
 - 24 Level 1 and Level 1+ keyways
 - 24 Level 2, 3 and 4 keyways
 - 24 Everest 29 Primus and Everest 29 Primus XP keyways
- 25 Key-in-knob/key-in-lever cylinders
 - 25 Schlage lock sets
 - 26 Key-in-knob/key-in-lever competitive cylinders
 - 27 AD-Series key-in-lever cylinders
 - 27 AD-Series competitor cylinder tailpieces
 - 27 AD-Series Schlage full size cylinder tailpiece
- 28 Mortise cylinders
 - 29 Schlage Primus mortise cylinder cams to operate other manufacturers' locks
 - 30 Concealed shell mortise cylinders
 - 31 Mortise full size cylinders
- 31 Full size interchangeable cores
- 32 Deadlock cylinders
- 33 Cabinet lock and portable security cylinders
- 34 Rim cylinders
- 35 Classic Primus keys
- 36 Everest Primus keys
- 37 Bulk packs
- 38 Tailpieces
 - 38 Multiple tailpiece key-in-knob/key-in-lever cylinders
- 39 Tools and sales support items
- 40 Interpreting box labels
- 41 Three parts to key control
- 42 Ordering Primus
 - 42 Cylinders
 - 42 Cylinder bulk packs

Introduction

Key systems

Patented key systems prevent unauthorized duplication of keys providing greater key control and reduced threat of a compromised key system. Everest 29 keyway families provide the flexibility to secure and restrict the most sensitive openings in a facility while maintaining access control across the entire system.

Everest 29™ is patent protected through 2029 and delivers a higher level of security because it cannot be duplicated without authorization. The backward compatibility of Everest 29 keyways to the legacy Everest keyways provides you with flexibility and security that adapts to your needs. Everest 29 keys will work in existing Everest keyway, but current Everest keys will not work in new Everest 29 keyway. This is because of the patent enabling feature of Everest 29 and what prohibits duplication of the new Everest 29 keys.

Everest 29, Everest, and Classic key systems can be enhanced and restricted to limited distribution with the addition of Primus XP. Primus XP, Schlage's high security sidebar cylinder mechanism, introduces an added level of security control. It delivers patented key control, geographical exclusivity, and pick resistance with the option of adding UL 437 drill resistance.

Whether you're retrofitting a building or implementing a key system for a newly constructed complex, Schlage key systems deliver the security you need at every level throughout your building, campus, or worldwide facility.

Everest 29 keyway			Everest keyway			Classic keyway			
EVEREST 29 [™] PRIMUS XP	EVEREST 29 [™] PRIMUS	EVEREST 29 [™]	EVEREST [™] PRIMUS XP	EVEREST [™] PRIMUS	EVEREST [™]	PRIMUS XP	PRIMUS	CLASSIC	
•	•	•							Patented until 2029
			•			•			Patented until 2024
				•	•				Patented until 2014
•	•	•	•	•	•	•	•	•	Commercial applications
•	•		•	•		•	•		Maximum key duplication restrictions
		•		•	•				Some key duplication restrictions
								•	No key duplication restrictions
		•			•				SFIC available
		•			•				Check pin
•	•		•	•		•	•		Finger pins/side bar configuration
•			•			•			#7 Finger pin used for added security
•	•	•	•	•	•	•	•	•	Bulk pack available
•	•	•	•	•	•			•	Master keying available for all levels
						•			Master keying available for levels 1+, 2, 3 and 4
							•		Master keying available for levels 2, 3 and 4

Introduction

Primus and Primus XP compatibility

Primus and Primus XP cylinders can be incorporated into any system using classic keyways including master keyed systems with no adverse effects on the system's expansion.





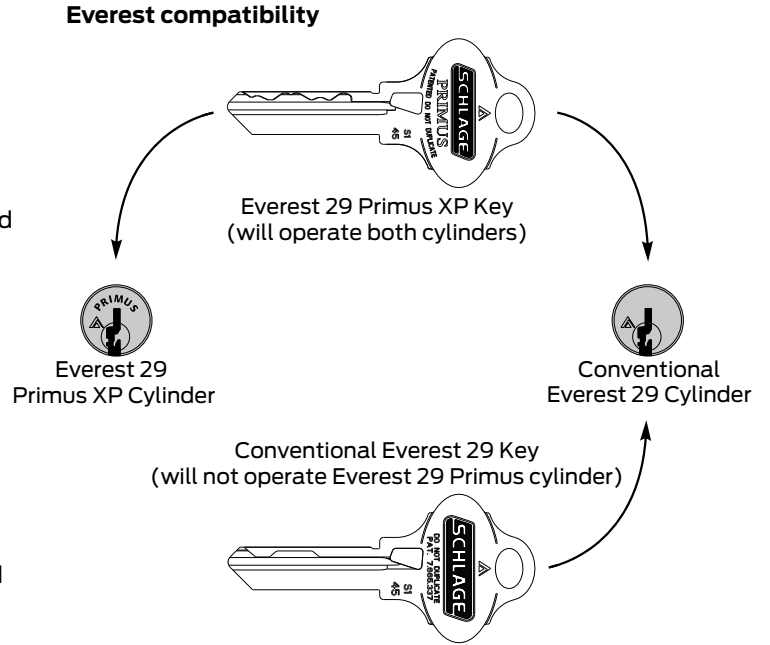

Everest Primus and Everest Primus XP compatibility

Everest 29 Primus, Everest Primus, Everest 29 Primus XP, and Everest Primus XP cylinders can be incorporated into any system using the Everest 29 and Everest keyway including master keyed systems with no adverse effects on the system's expansion. This would include use with Everest 29 and Everest Open cylinders and Everest 29 and Everest Restricted cylinders.

Serviceability

It is unnecessary to invest in any additional servicing equipment for pinning than what is needed to service conventional cylinders. The side biting is cut into the key blanks at the factory and the keys are able to be combined using standard key cutting equipment.



Cylinder differences				
	PRIMUS	PRIMUS XP	 EVEREST 29 [™] PRIMUS	 EVEREST 29 [™] PRIMUS XP
Keys and key bows	 <ul style="list-style-type: none"> The word "Primus" is stamped on the back of the key bow. Standard key is embossed on both sides. Available embossed on only one side. Same as Classic Key shape with limited stamping space. 	 <ul style="list-style-type: none"> The word "Primus" is stamped on the back of the key bow. Standard key is embossed on both sides. Available embossed on only one side. Same as Classic Keys shape with limited stamping space. 	 <ul style="list-style-type: none"> The word "Primus" is stamped on the front of the key bow. Standard key is embossed on one side. Plain bow available. 20% larger than Classic Primus keys with a larger stamping area on key bow. 	 <ul style="list-style-type: none"> The word "Primus" is stamped on the front of the key bow. Standard key is embossed on one side. Plain bow available. 20% larger than Classic Primus keys with a larger stamping area on key bow.
U.S. Patents	None	U.S. 7,159,424	US 5,715,717, 5,809,816, 7,665,337	US 5,715,717, 5,809,816, 7,159,424, 7,665,337
Id numbers	Locksmith ID stamped on Level 1+ Keys.	Locksmith ID stamped on Level 1+ keys.	ID numbers stamped on every key.	ID numbers stamped on every key.
Key sections stamping	Optional	Optional	Standard. Key sections stamped on all keys and plugs.	Standard. Key sections stamped on all keys and plugs
Master keying*	Available for Level 2, 3, and 4 keying systems.	Available for Level 1+, 2, 3, and 4 keying systems.	Available for all sections and all levels.	Available for all sections and all levels.
(Nominal) key thickness	.092"	.092"	.106"	.106"
#7 Finger pin available	No	Yes	No	Yes

* Ordering Primus master keyed products is similar to ordering any other Schlage master keyed products with the one addition of the necessary Primus forms (Face sheet and signature form as needed, see page 43-46).

Terminology

Keyways

Classic

Schlage pin tumbler keyways which existed before Everest keyways. Obverse is the name of the open family of keyways (C, E, etc.) and there are three other families of restricted keyways: Reverse, Numbered, and Quad.

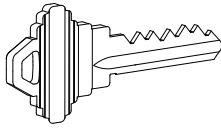

Everest

Cylinders and keys which incorporate all new keyways with the patented undercut groove on the right side of the key section.

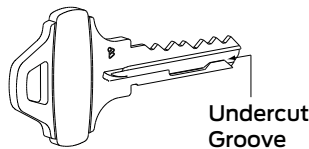

Everest 29 S Family refers to the open family of keyways. R Family (for SFIC) and T Family keyways are restricted.

Cylinder mechanisms

Conventional cylinders

Standard cylinders which incorporate a series of locking top pins.

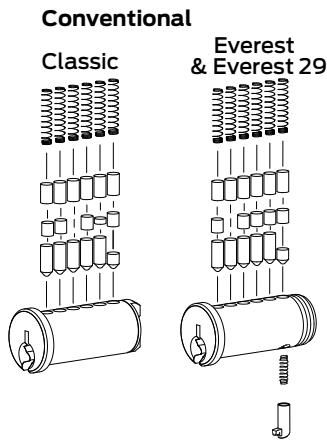

Primus cylinders

Schlage's high security sidebar cylinder mechanism provides key control, geographical exclusivity, and pick resistance, standard. UL437 drill resistance is optional. Primus keys operate conventional cylinders.

Primus

Classic, Everest Primus, & Everest 29 Primus

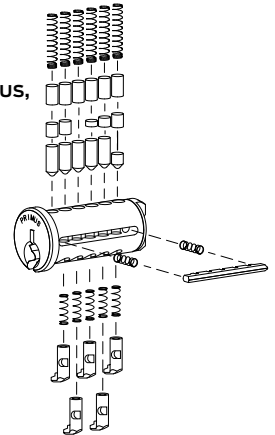

Key control

Restricted keyways

Special non-stock keyways set aside for limited use and a higher degree of key control.

A letter of authorization from the end user is required to process orders for Restricted keys, blanks, and cylinders.

Open keyways

Standard keyways available without any ordering formalities. S Family (Everest 29), C Family (Everest) and Obverse (Classic) keyways are open.

Cylinder category

Full size

Pertaining to cylinders (including interchangeable cores), keys, and keyways based on the industry standard plug diameter of about 1/2". All Schlage cylinders except SFIC are full size.

Small format interchangeable core (SFIC)

A core providing patented key control that is completely interchangeable with Best and its other clones, offered in Everest 29 R, Everest B Family restricted keyways. No Primus version exists.

Pins, springs, keys and keyways are based on a plug diameter smaller than the standard 1/2".

Full Size Examples

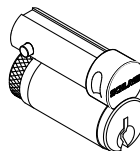

Full Size IC

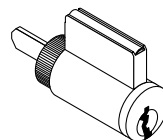

Key-in-Knob/Lever

SFIC Example

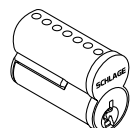

Construction and operating principles

The Primus/Primus XP cylinder is a conventional Schlage cylinder with a few modifications. A sidebar and finger pins are added to the conventional cylinder to provide additional security.

The Primus/Primus XP key has a secondary biting on the side of the blade to accommodate the finger pins. When the key is inserted, each of the side bit cuts lifts the finger pin and rotates it so that the notches in the side bar align with the notches in the back of the finger pins.

When all notches on the side bar and back of the finger pins are aligned and the regular pins are aligned at the shear line the plug is free to rotate.

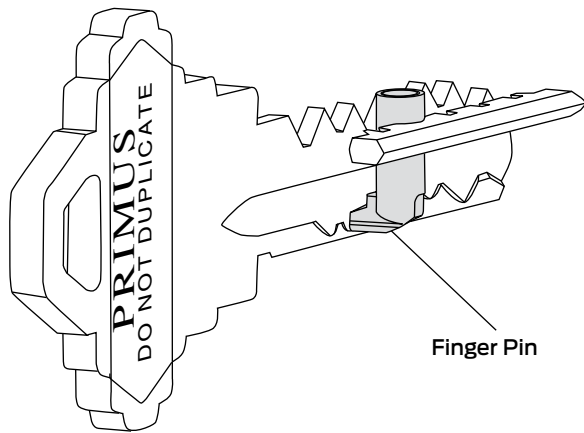

Secondary side biting

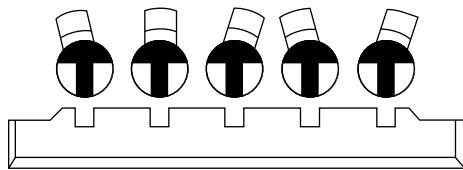

Finger pins rotated

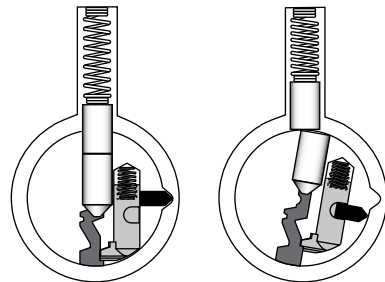

Locked

Unlocked

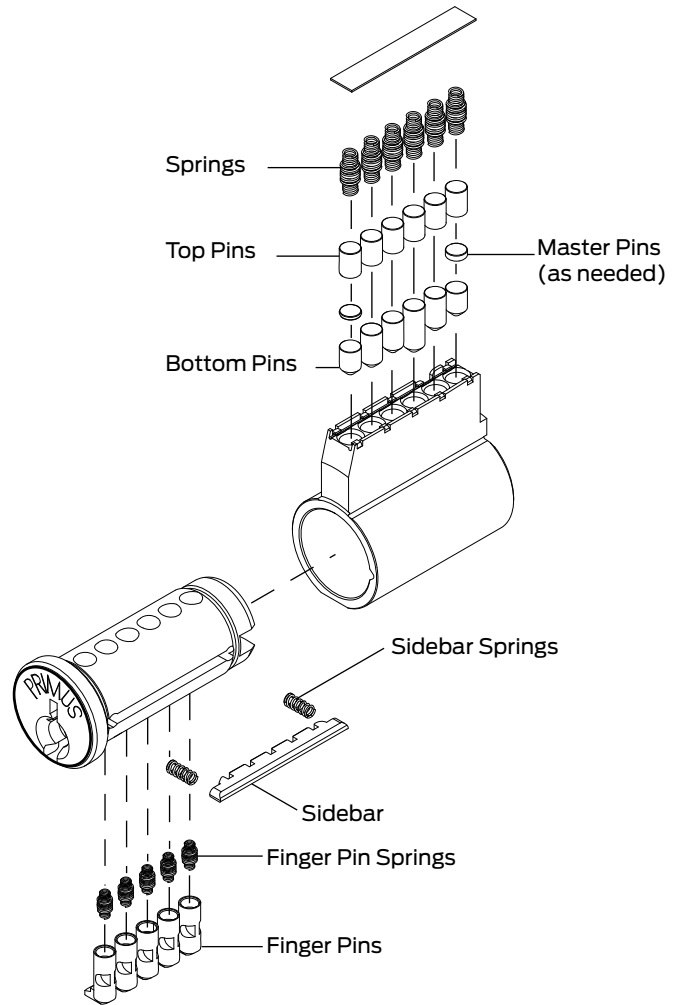

Modular cylinders

Introduced in April 2010, the Schlage modular cylinder provides easy convertibility between key-in-lever to mortise and rim cylinders. These benefits make Schlage cylinder inventory flexible, reduce the size and cost of inventory and customer lead time, and increase customer satisfaction. With a few modular components in stock, the cylinder type and finish required will always be on hand. The modular cylinder accepts a tailpiece or a mortise cam.

Product line availability: A, AL, B, CL, D, H, L, ND, S, S200, Kryptonite (PL, KS, KC), and Rim (standard and lockout). All competitive locks that accept Everest® Primus will also accept the modular cylinders.

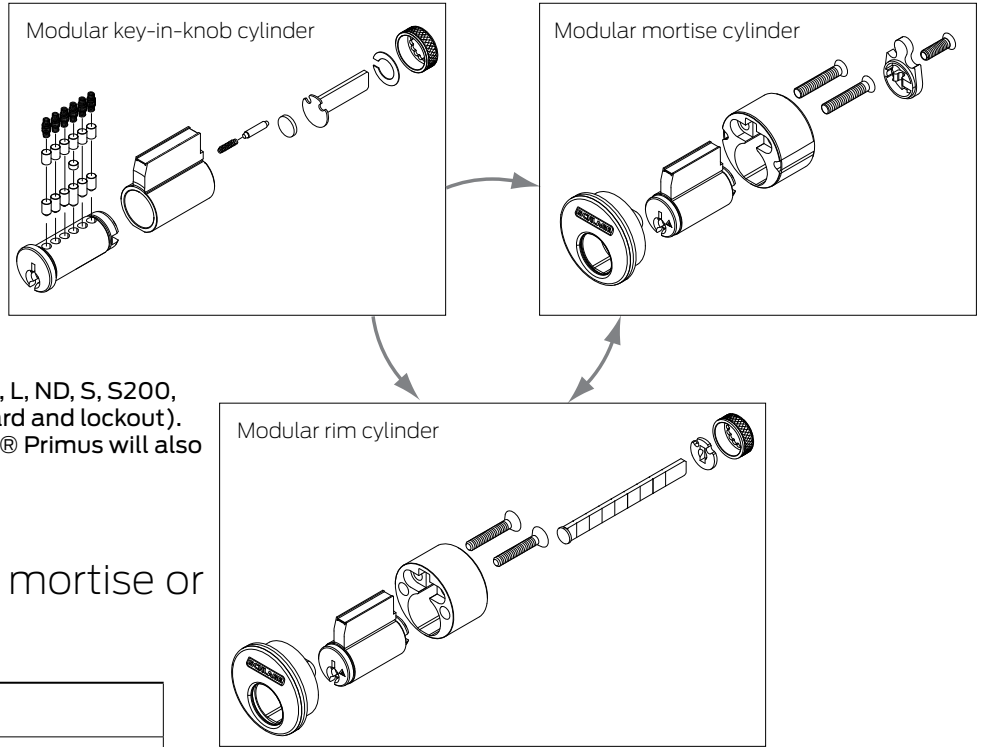

Key-in-knob to modular mortise or rim cylinder conversion

Modular housing interchangeability				
Housing		Cam	Cam screw	Plug extension
Part no.	Size	Part number		
B520-721	1 1/8"	L583-474	B520-690	—
B520-722	1 1/4"	L583-475	B520-690	—
B520-723	1 3/8"	L583-474	B520-691	B590-298
B520-724	1 1/2"	L583-475	B520-691	B590-298
B520-725	1 5/8"	L583-474	B520-692	B590-299
B520-726	1 3/4"	L583-475	B520-692	B590-299

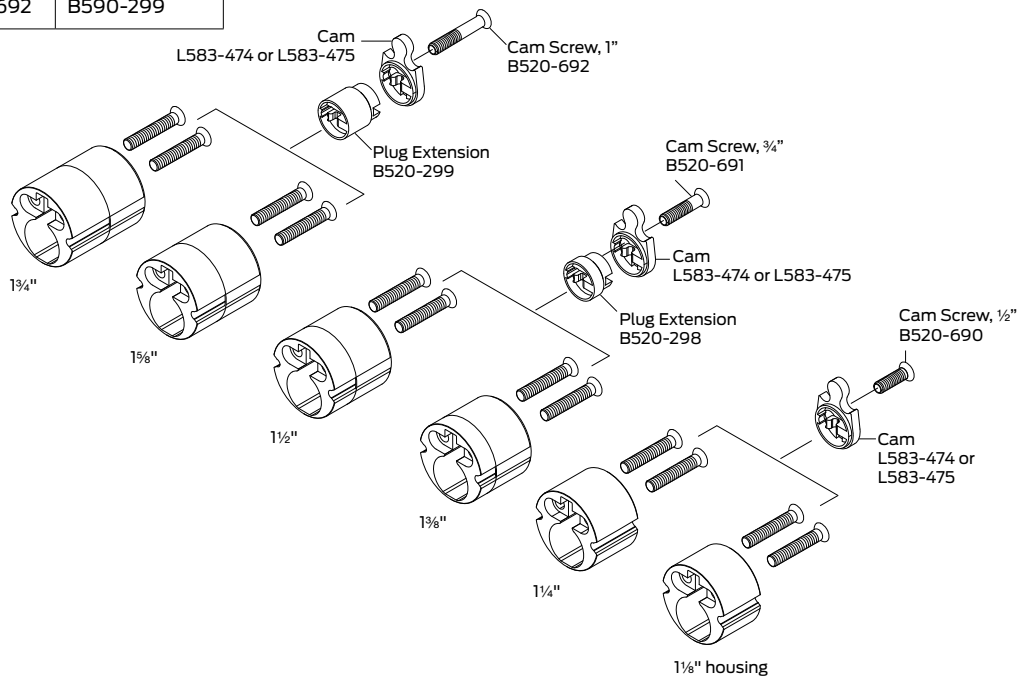

Cam and tailpiece differences

Prior to April 2010, the cams and tailpieces used in the Primus/Primus XP cylinders were different than conventional cams and tailpieces because of the location of the sidebar and finger pins.

The illustrations below are rear views of the mortise cylinder as well as the key-in-knob/key-in-lever cylinders showing the differences in screw and cap pin locations. All Everest 29 keyway cylinders use the Primus/Primus XP screw and cap pin location.

Traditional cylinders (prior to July 2010)

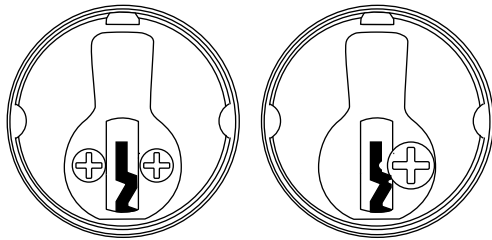

Conventional Classic

Primus & Everest 29

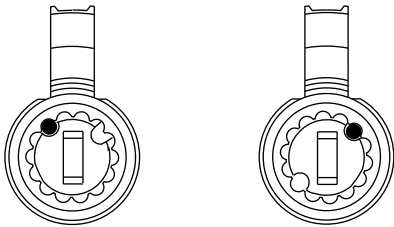

Modular cylinders

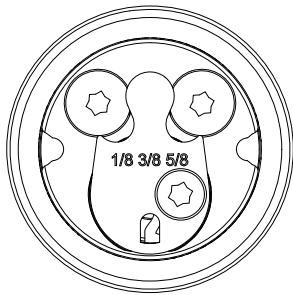

Mortise

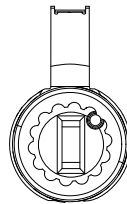

KIK, KIL, Everest 29, Primus, & Classic

Full size interchangeable core (FSIC)

Schlage introduced its Full Size Interchangeable Core (FSIC) in 1984. Like the key-in-knob/key-in-lever cylinders, the core uses a cap pin and spring mechanism, but the cap pin also serves to drive the cam or tailpiece.

Housings and tailpieces manufactured before the Primus core was introduced only had clearance for the conventional cap pin. Now, all FSIC housings and tailpieces are made to accommodate both cap pin locations.

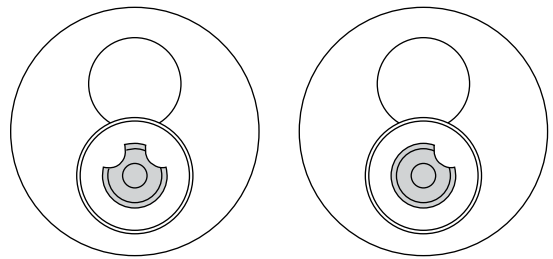

Current Design

Pre-1992

UL437

Each Schlage cylinder is available in a standard configuration as well as with a UL437 option. The catalog numbers associated with a standard cylinder are 20-7XX while the catalog numbers associated with the UL437 cylinder are 20-5XX.

The UL437 Primus/Primus XP cylinders incorporate drill resistant components for additional security.

Modular cylinder note:

With the introduction of the Modular Cylinder, the cap pin & spring location was moved to the upper right when viewed from the rear. Additionally, the cam attachment types were standardized to a single screw attachment. Cams are available to fit multiple manufacturers' lock designs and are separated by increments. One cam covers 1/8", 3/8", and 5/8", and the other cam is designed for 1/4", 1/2", and 3/4" increments.

Lockout cylinder

Lockout cylinder

The Primus/Primus XP lockout cylinder is for use in applications in which it is necessary to temporarily disable the cylinder. It is essentially a very basic access control device.

The lockout cylinder utilizes a standard 6-pin chamber row as well as a 4-pin chamber row with a special key.

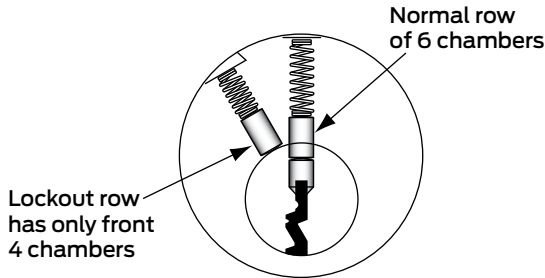

When the plug is in its standard operating position all keys will operate the lock. To temporarily disable to regular operating keys, the plug can be turned with the special key to align the bottom pins with the lockout row of pins.

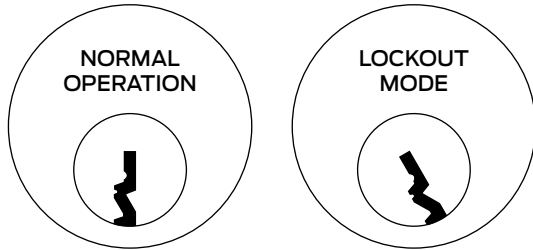

Pinning rules

1. The fifth cut must be at least a #3 depth and the sixth cut must be equal to or deeper than the fifth cut.
2. Lockout cylinders must NOT be master keyed. When keys are inserted quickly, master pins may remain in the shell. This could cause a lockout, trap an operating key, or just prevent further operation of the cylinder.

How the lockout cylinder works

Operating key turned to the Lockout Position

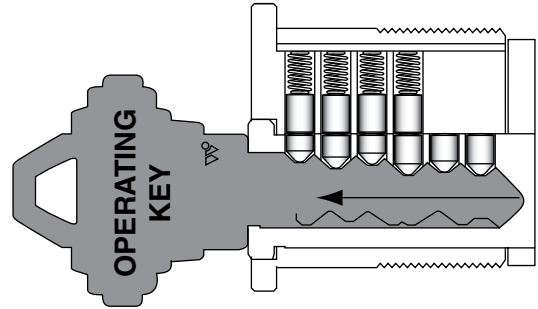

The operating key cannot be removed in the lockout position because the back two pins are unable to disengage from the key.

Lockout key turned to the lockout position

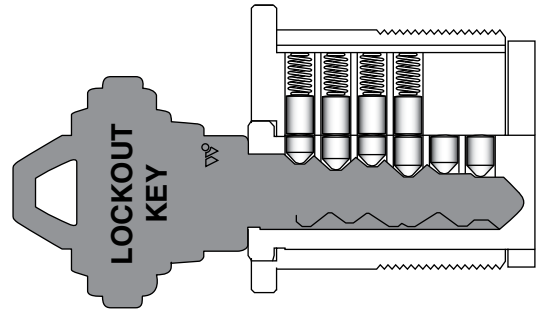

The last two notches in the key are removed allowing the key to exit the cylinder.

Operating key entering in lockout position

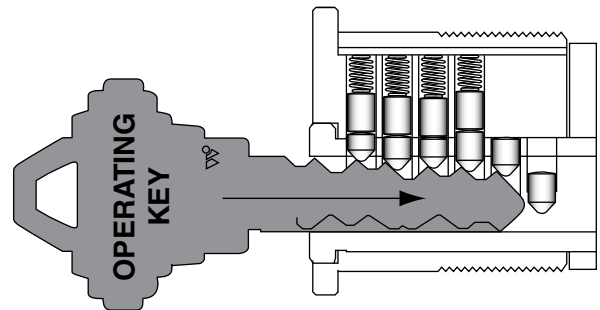

The operating key cannot enter the cylinder because the back two pins are not able to settle into their biting spaces on the key.

NOTE: Lockout cylinders are not available in the new modular cylinder design.

Key bitting specifications

Key bitting specifications

The following specifications are the same for Schlage Classic™ keys, including Primus®

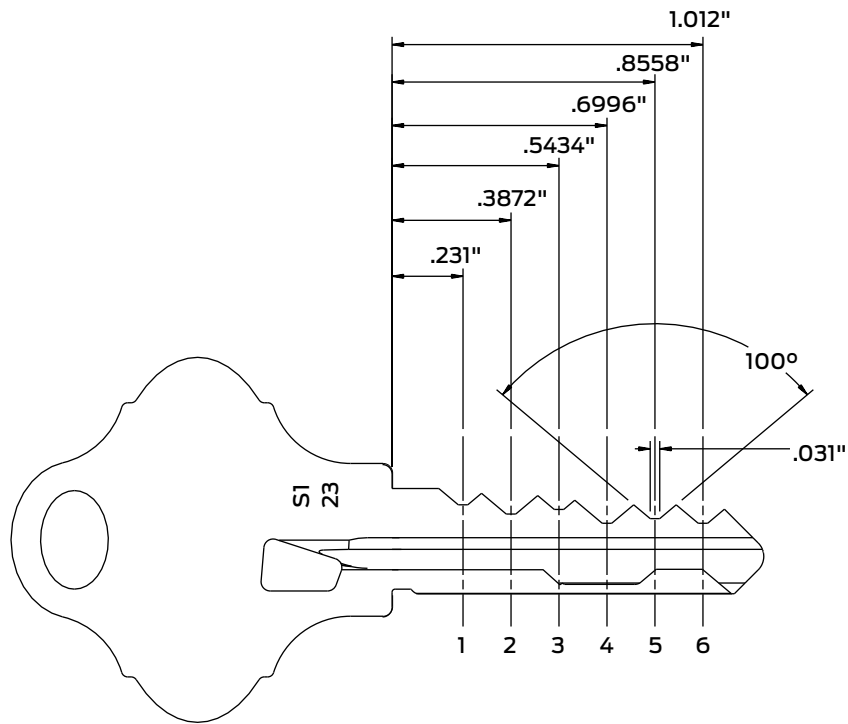

MACS = 7	
Increment:	0.15"
Progression:	Two Step
Blade Width:	.343"
Depth Tolerance:	+ .002" - 0
Spacing Tolerance:	± .001"

Root depths			
0	.335"	5	.260"
1	.320"	6	.245"
2	.305"	7	.230"
3	.290"	8	.215"
4	.275"	9	.200"

Cuts are read and written bow to tip. The patented Primus side bitting process is done at the Schlage factory. Key blanks have side bitting already milled.

Pins and springs

Bottom pins		
Size	Length	Part no.
0	.165"	34-300
1	.180"	34-301
2	.195"	34-302
3	.210"	34-303
4	.225"	34-304
5	.240"	34-305
6	.255"	34-306
7	.270"	34-307
8	.285"	34-308
9	.300"	34-309



Master pins		
Size	Length	Part no.
2	.030"	34-202
3	.045"	34-203
4	.060"	34-204
5	.075"	34-205
6	.090"	34-206
7	.105"	34-207
8	.120"	34-208
9	.135"	34-209



Other pins and springs	
Description	Part no.
Tumbler Spring	C503-113
Finger Pin Spring	C603-951
Sidebar	C603-950
Sidebar Spring	C603-952
Cap Pin	C503-116
Cap Pin Spring	C503-115

Finger pins	
Size	Part no.
1	34-001
2	34-002
3	34-003
4	34-004
5	34-005
6	34-006

Top pins			
Size	Length	Part no.	Application
1	.235"	34-101	Plug total = 0, 1, 2, 3
2	.200"	34-102	Plug total = 4, 5, 6
3	.165"	34-103	Plug total = 7, 8, 9



Key biting specifications

Reading keys

All keys will have exactly six Standard cuts and five Side Bit cuts, which should be read from the bow of the key to the tip.

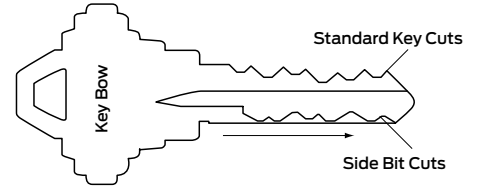

Standard cuts

Standard key cuts should be read using the Schlage Key Gauge (40-104). Insert key into widest end and slide until key stops. The nearest number is the key cut depth.

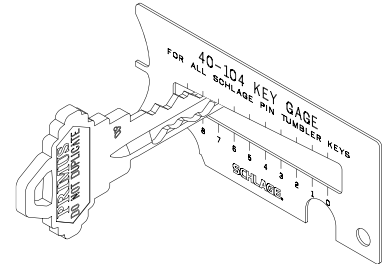

Side bit cuts

There are six side bit cut possibilities for Primus and Everest Primus and seven side bit cut possibilities for Primus XP and Everest Primus XP.

Each of the side cuts raise and swivel the finger pin in order to align the notch in the pin to the notch in the side bar.

If a side cut is misread, the pin will not align with the side bar by being too high, too low or rotated in the wrong direction.

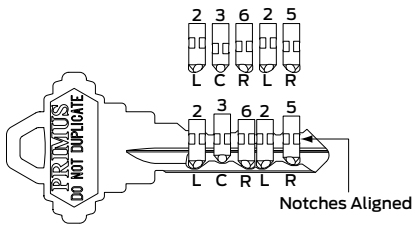
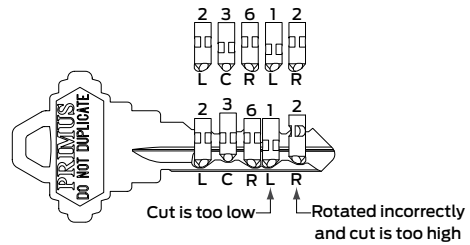

Reading side pins

Learning to read finger pins is useful because pins can get spilled or mixed in with other size finger pins.

In 1998 the bottom of the finger pin was redesigned. This does not affect the functionality of the pins or the technique used for reading the pins.

2. Determine the depth

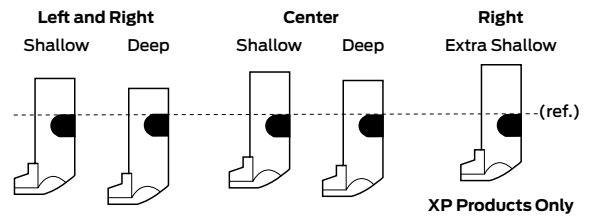

1. Determine the angle

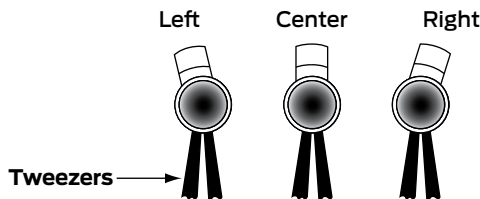

3. Convert angle and depth to numbers

	Left	Center	Right
Deep	2	4	6
Shallow	1	3	5
Extra shallow			7

Key control levels overview

Below is a chart that provides an overview and comparison of the different Key Control levels. In-depth information is covered in the pages following.

Dealer controlled systems

Dealer controlled systems are sold and serviced by the locksmith or dealer who sold the system. End users must order keys and request servicing through the original dealer.

End user exclusive systems

End User Exclusive Systems are sold directly to and controlled by the end user. The systems are generally sold to larger businesses or those that need a very high level of security. Side bit milling is exclusive to the end user based on either a random assignment, the first two digits of the zip code, time zone or on a nationwide basis.



Classic Primus XP

Ideal for existing key systems
patent protected through 2024



Everest 29 Primus XP

Ideal for new key systems
patent protected through 2029

	Dealer controlled system	Typical applications	End User Exclusive Systems	
Level 1 XP	<p>National non-exclusive Stocked by distributors and resold to end users via commercial locksmiths; All Level 1 locksmiths have the same side bit millings.</p>	<ul style="list-style-type: none"> Strip mall shops Small businesses Upscale homes 	<p>Consider Everest 29 open for commercial exclusivity</p>	
Level 1+ XP	<p>Dealer exclusive Owned & stocked by dealers; resold to end users. Keys bear unique Dealer ID based upon three digit zip-code exclusivity of side bit milling.</p>	<ul style="list-style-type: none"> Small businesses Restaurants Doctor's offices 	<p>Dealer exclusive Owned & stocked by dealers; resold to end users. Keys bear unique Dealer ID based upon three digit zip-code exclusivity of side bit milling.</p>	Level 7 XP
Level 2 XP	<p>Dealer exclusive Dealers that sell directly to end users are eligible for side bit milling exclusivity. Exclusivity is for the dealer physical location time zone.</p>	<ul style="list-style-type: none"> Office buildings Banks Private schools Healthcare residences 	<p>Dealer exclusive Dealers that sell directly to end users are eligible for side bit milling exclusivity. Exclusivity is for the dealer physical location time zone.</p>	Level 8 XP
Level 3 XP	<p>End user exclusive Exclusivity is based on either random assignment or on the first 2 digits of the zip code, depending on end user commitment.</p>	<ul style="list-style-type: none"> Educational facilities Healthcare facilities Large office complexes 	<p>End-user exclusive Exclusivity is based on random assignment, on the first 2 digits of the zip code, on time zone, or on a nationwide basis, depending on end user commitment.</p>	Level 9 XP
Level 4 XP	<p>End user exclusive Exclusivity is based on either a time zone or nationwide basis, depending on end user commitment.</p>	<ul style="list-style-type: none"> Government buildings Detention centers Franchises 		

Primus and Primus XP level 1

Overview for end user

- Level 1 is designed for small to medium size businesses.
- Keys cannot be duplicated at hardware stores or mall key stands.
- ID cards are issued from the original locksmith.
- Keys are available from any Level 1 dealer in the country by presenting the proper identification and the key to be duplicated.
- All keys must be cut by a security dealer.
- The end user does not have access to key blanks.

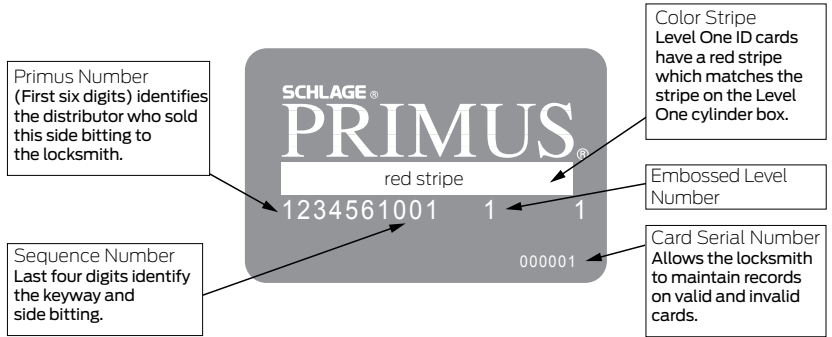

Overview for locksmith or security dealer

- Easy introduction to Primus and Primus XP sales.
- Same side biting nationwide.
- No minimum order required.
- No sole source relationship with distributor or customers.
- Level 1 contract required with each distributor used to purchase products.

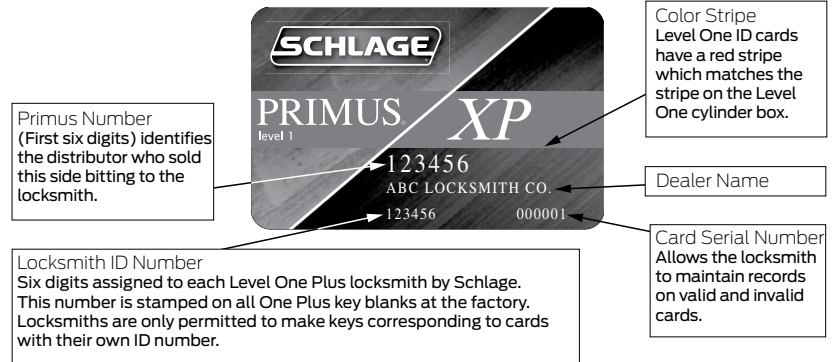

As covered in the contract, it is important for a Level 1 dealer:

- to safeguard Primus and Primus XP key blanks
- not to give, sell or lend key blanks to anyone under any circumstances
- to sell directly to end users only
- to issue a Level 1 ID card to each end user
- to require ID card and signatures before duplicating any Level 1 keys
- to maintain accurate records of all keys.

Keyways and keying options

Level 1 is primarily for upgrading users of C or E keyway conventional cylinders, so CP and EP are the principle keyways at this level. However, the other five keyways are available through some distributors.

- Level 1 is not appropriate for large key systems.
- The side bittings chosen for Level 1 keys limit master key systems to one keyway.
- Multi-section key blanks cannot be made because of the incompatible side bittings of the lower level keys.
- Level 1 cylinders are shipped 0-bitted.
- All keying is done in the field.

Sequence numbers

The sequence number is a 4-digit code which identifies the combination of side biting + keyway. Since the side bittings of Level 1 are shared by all dealers nationwide, there is only one sequence number per keyway. The sequence number can be used to distinguish inventory for dealers and distributors who stock more than one level of Primus.

Primus	
Side biting 62266	
Sequence #	Section
1001	CP
1002	EFP
1003	FGP
Side biting 62422	
Sequence #	Section
1004	CEP
1005	FP
Side biting 62422	
Sequence #	Section
1006	EP

Primus XP	
Side biting 62766	
Sequence #	Section
1001	CP
1002	EFP
1003	FGP
Side biting 22473	
Sequence #	Section
1004	CEP
1005	FP
1006	EP

Primus and Primus XP level 1+

Overview for end user

- Designed for small to medium size key systems.
- Limits availability of keys to one locksmith company.
- Only the company that maintains the key records and key issue authorizations for the end user's system can cut the keys.
- The end user receives an ID card from the original locksmith company.
- The end user presents ID card to the locksmith together with signature card to obtain additional keys.
- All keys bear the locksmith's 6-digit ID number.
- No other locksmiths are permitted to cut keys.
- The end user does not have access to key blanks.

Overview for locksmith or security dealer

- Ties end users to dealer for their Primus and Primus XP systems.
- Primus Level 1+ Locksmith is tied to the wholesaler for key blanks. Primus XP Level 1+ Locksmith can purchase key blanks from any wholesaler and will be given side bitting exclusivity based on the first 3 digits of the locksmith's zip code.
- Key blanks are stamped with dealer ID number.
- Classic Wholesaler has its own side bitting and selects which of its dealers will handle the product.
- Keys bear a unique ID based upon side-bitting.
- Other locksmiths in the area may have the same side bitting, but are not authorized to cut keys with other dealer's ID number.
- Primus Level 1+ wholesalers stock 0-bitted cylinders with their side combination. Primus XP Level 1+ wholesalers can stock subassembled bulk, KA, KD.
- Key blanks are shipped from Schlage and invoiced through the wholesaler.

Becoming a level 1+ dealer

To become a Level 1+ dealer, sign the appropriate contract with your wholesaler and purchase the prevailing minimum dollar amount of inventory. Dealer's ability to sell high security products and provide end user service must be reviewed and approved by a Schlage SSC sales manager.

As covered in the contract, it is important for a Level 1+ dealer:

- not to cut keys for any other Primus and Primus XP Level 1+ systems as identified by the ID number on each key
- to safeguard Primus and Primus XP Level 1+ key blanks and ID cards
- not to give, sell or lend key blanks to anyone under any circumstances
- to require and validate a signature before duplicating any Level 1+ keys
- to maintain accurate records of all keys cut.

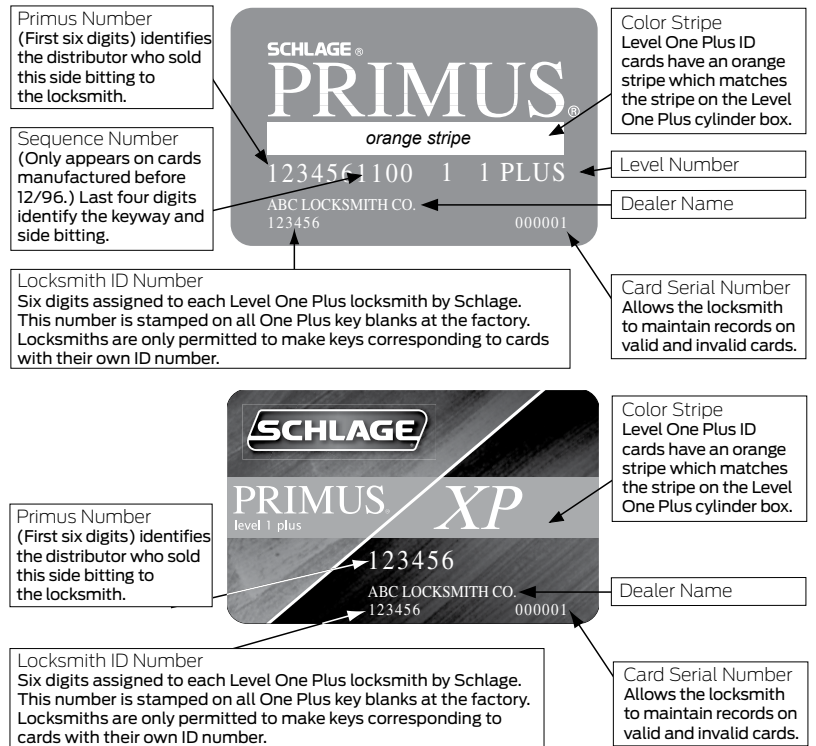

Keyways and keying options

- Level 1+ is not appropriate for large key systems.
- Key blanks are not available to institutional locksmiths.
- Side bittings for Level 1+ limit systems to one keyway.
- Multi-section key blanks cannot be made because of the incompatible side bittings of the lower level keys.
- Primus Level 1+ cylinders are shipped 0-bitted. Primus XP Level 1+ can be shipped 0-bitted, KA, KD, MK and bulk packed.

Sequence numbers

The sequence number is a 4-digit code which identifies the combination of side bitting + keyway. Since virtually every Schlage wholesaler and Locksmith carrying Primus XP Level 1+ product has a different side bitting and some carry more than one, the sequence number can be useful to separate inventory having the same keyway but different side bittings. At Level 1+, each sequence number is assigned to one specific wholesaler. With Primus XP, the use of sequence numbers was discontinued.

Key control levels overview

Primus and Primus XP Level 2

Overview for end user

- Designed for medium to large size key systems.
- Availability of keys is limited to one specific hardware dealer.
- The end user enters into a sole source relationship with the dealer.
- The original dealer is the only one that can supply keys.
- The end user receives an ID card from the original dealer.
- The end user presents an ID card together with signature to obtain additional keys.
- The end user does not have access to key blanks.
- No other hardware dealers or locksmiths in the area have access to blanks with the dealer's side bitting.

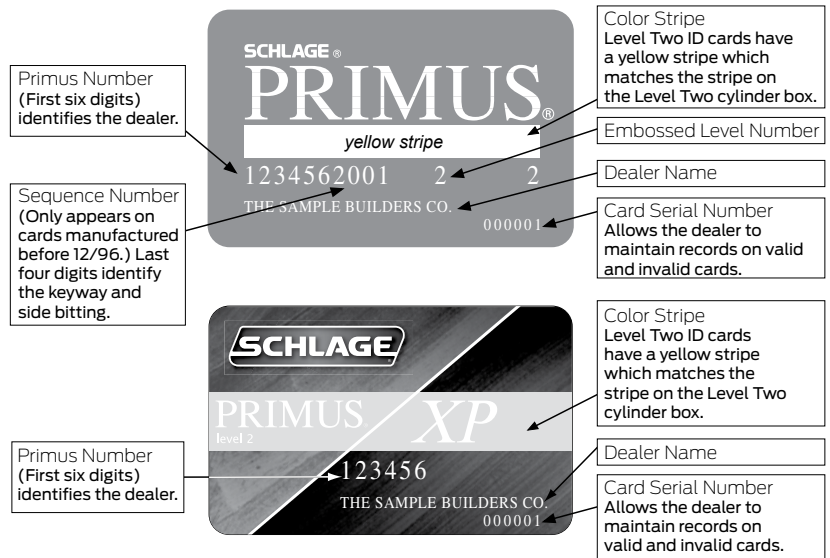

Overview for locksmith or security dealer

- Requires a substantial inventory buy-in.
- Ties all end users to a dealer for Primus and Primus XP Level 2 keys.
- The dealer must provide key duplication and cylinder service because the end user cannot go elsewhere for keys.
- Each dealer is assigned a time zone exclusive pair of side bittings.
- No two dealers in the same time zone will have the same side bittings.

Level 2S

This side bitting is assigned to the dealer for KA and KD stock, and key systems the dealer generates in the field. The dealer must maintain all records for these systems.

Becoming a level 2 dealer

To become a Level 2 dealer, sign the appropriate contract with Schlage and purchase the prevailing minimum dollar amount of inventory. The dealer's ability to sell high security products and provide end user service must be reviewed and approved by a Schlage SSC sales manager.

As covered in the contract, it is important for a Level 2 dealer:

- to safeguard Primus and Primus XP Level 2 key blanks and ID cards
- not to give, sell or lend key blanks to anyone under any circumstances
- to require and validate a signature before duplicating any Level 2 keys
- to maintain accurate records of all keys cut
- to not make any Level 2 keys for systems generated by dealers in other time zones who may have the same side bitting.

Keyways and keying options

The geographical exclusivity of Level 2 makes it impractical to illustrate or list all the side bittings. New ones are issued every day around the country.

- The dealer is responsible for all key bittings and key control measures.
- Multi-section keys are available for this level.
- The LP blank is made of stainless steel and cannot be cut on most key machines in the field. Therefore, most customers should order cut keys rather than blanks.

Primus and Primus XP Level 3 and 4

Overview for end user

- Schlage's highest level of key control and exclusivity on Classic keyways.
- Levels 3 and 4 use the same authorization procedures.
- Levels 3 and 4 differ only by the amount of geographical exclusivity purchased.
- The end user has access to key blanks and cuts keys.
- The end user generates and maintains their own key system.
- A signed original Primus Face Sheet and signature card are required to set up initial End User Level systems.
- Every order must include a signed original Face Sheet which is closely checked for an authorized signature. No faxes or photocopies are acceptable due to the ease of forgery.
- The end user can get competitive bids and order End User Level material from any one of a large number of authorized dealers nationwide.

The degree of geographical exclusivity of end user side bitting is determined with the initial order as listed below.

Level 3U

Fewer than 60 cylinders. Schlage randomly assigns a side bitting from a small pool of combinations which may be repeated locally. There are no guarantees of geographical exclusivity.

Level 3G (geographical)

More than 60 cylinders. Schlage assigns an exclusive side bitting based on the first two digits of the end user's zip code.

Level 4Z (time zone)

Minimum of 2000 cylinders over two years or pay a fee. The end user buys exclusivity of one side bitting within the end user's time zone and country.

Level 4N (nationwide)

Minimum of 4000 cylinders over two years or pay a fee. The end user buys nationwide exclusivity of one side bitting.

Overview for locksmith or security dealer

- These levels are for end users who want to cut their own keys and/or generate their own key system.
- Dealers already selling Level 2 or 8 are authorized to sell Level 3 and 4 products.
- Level 1+ and 7 dealers must sign an additional key control contract, but there is no buy-in required.
- The degree of geographical exclusivity is determined by the end user's commitment to cylinder volume and separate exclusivity purchases.

Keyways and keying options

The geographical exclusivity of these levels makes it impractical to illustrate or list all the side bittings. New ones are issued every day around the country.

- Dealers cannot stock this level.
- All cylinders, keys and blanks are shipped to the end user's designated location.
- Multi-section keys are available for this level, so it will accommodate larger systems.
- In the Obverse keyway family, the end user can use up to six keyways. Larger systems must either be broken up or furnished in Quad restricted keyways. (Restricted means that Schlage requires a letter of authorization from the end user even for conventional keys and blanks on these key sections.)

Everest Primus and Everest Primus XP level 7

Overview for end user

- Designed for small to medium sized key systems.
- Availability of keys is limited to one specific locksmith company.
- The end user enters into a sole source relationship with a commercial locksmith company.
- The original supplier is the only company that can supply additional keys.
- End user receives an ID card from the original locksmith.
- Present ID card and signature to obtain additional keys.
- All keys bear the locksmith's six-digit ID number.
- The end user does not have access to key blanks.
- No other locksmiths are permitted to cut keys.

Overview for locksmith or security dealer

- Everest Primus Level 7 Locksmith tied to wholesaler for key blanks. Everest Primus XP Level 7 Locksmith can purchase key blanks from any wholesaler and will be given side biting exclusivity based on the first three digits of locksmith's zip code.
- Other locksmiths in the area may have the same side biting.
- Everest Primus Level 7 wholesalers stock 0-bitted cylinders with their side combination. Everest Primus XP Level 7 can be ordered KA, KD and MK.
- Key blanks are shipped to dealer from Schlage and invoiced through the wholesaler.

Becoming a level 7 dealer

To become a Level 7 dealer, sign the appropriate contract with the wholesaler and purchase the prevailing minimum dollar amount of inventory. Dealer's ability to sell high security products and provide end user service must be reviewed and approved by a Schlage SSC sales manager.

As covered in the contract, it is important for a Level 7 dealer:

- not to cut keys for any other Everest Primus and Everest Primus XP Level 7 systems as identified by the ID number on each key
- to safeguard Everest Primus and Everest Primus XP Level 7 key blanks and ID cards
- not to give, sell or lend key blanks to anyone under any circumstances
- to require and validate a signature before duplicating any Level 7 keys
- to maintain accurate records of all keys cut.

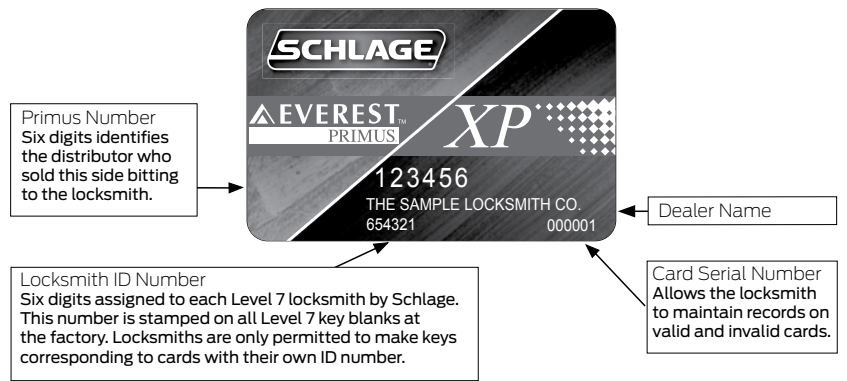
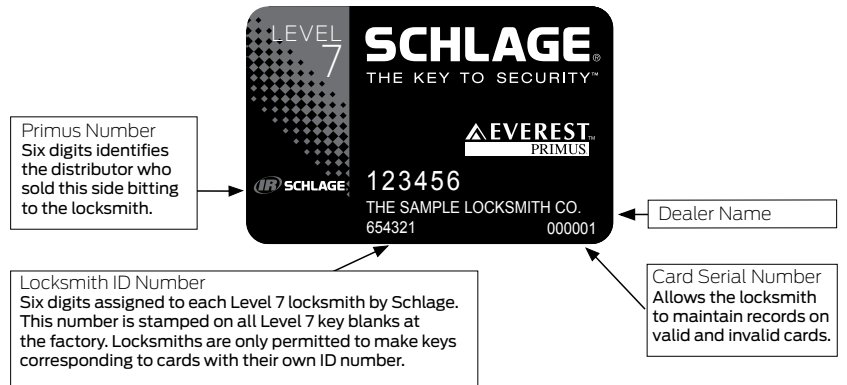

Keyways and keying options

Everest Open C family keyways are now Schlage's default keyways for new commercial key systems as well as for more commercial stock product. At Level 7, all Everest C family keyways are available, allowing integration into any existing system using these new Schlage keyways, as well as the ability to begin new C family key systems.

The last cut of the side bittings at this level is always shallow (1, 3 or 5) to raise the check pin of conventional Everest cylinders.

- Level 7 is not appropriate for key systems where the end user needs to cut keys on site.
- Key blanks are not available to institutional locksmiths.
- Level 7 cylinders are shipped 0-bitted, KA, KD, MK or bulk packed.

Everest Primus and Everest Primus XP level 8

Overview for end user

- Designed for small to large size key systems.
- Availability of keys is limited to one specific dealer.
- The end user enters into a sole source relationship with the dealer.
- The original dealer is the only one that can supply keys.
- The end user receives an ID card from the original dealer.
- The end user presents ID card together with signature to obtain additional keys.
- End user does not have access to key blanks.
- No other hardware dealers or locksmiths in the area have access to blanks with the dealer's side bitting.



Overview for locksmith or security dealer

- Requires a substantial inventory buy-in.
- Ties all end users to dealer for Everest Primus and Everest Primus XP Level 8 keys.
- Dealer must provide key duplication and cylinder service because end user cannot go elsewhere for keys.
- Each dealer is assigned one time zone exclusive side bitting.
- No two dealers in the same time zone will have the same side bittings.

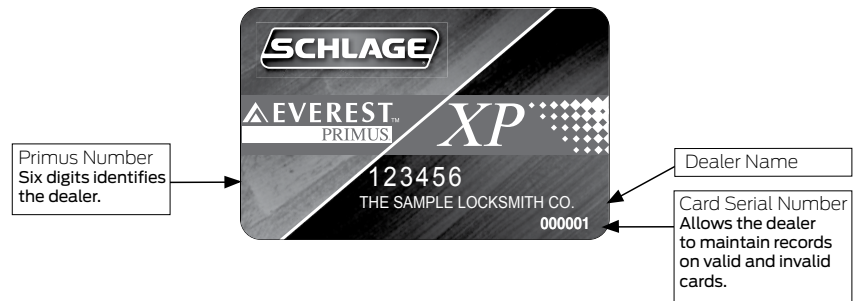

Becoming a level 8 dealer

To become a Level 8 dealer, sign the appropriate contract with Schlage and purchase the prevailing minimum dollar amount of inventory. Dealer's ability to sell high security products and provide end user service must be reviewed and approved by a Schlage SSC sales manager. As covered in the contract, it is important for a Level 8 dealer:

- to safeguard Everest Primus and Everest Primus XP Level 8 key blanks and ID cards
- not to give, sell or lend key blanks to anyone under any circumstances
- to sell directly to end users only
- to require and validate a signature before duplicating any Level 8 keys
- to maintain accurate records of all keys cut
- to not make any Level 8 keys for systems generated by dealers in other time zones who may have the same side bitting.

Keyways and keying options

The geographical exclusivity of Level 8 makes it impractical to illustrate or list all the side bittings. New ones are issued every day around the country.

- The last cut of side bittings at Level 8 is always shallow (1, 3 or 5) to raise the check pin of conventional Everest cylinders.
- With the ten Everest C family keyways available, large key systems are possible.
- Unlike Level 2, each Level 8 dealer is assigned one side bitting and the corresponding sequence numbers.

There is no differentiation between factory and field-originated systems.

Everest Primus and Everest Primus XP Level 9

Overview for end user

- Schlage's highest level of key control and exclusivity on Everest keyways.
- Level 9 is subdivided to be flexible for the amount of geographical exclusivity purchased.
- Side bit milling is assigned to the end user based on the exclusivity purchased. See level and commitments listed below.
- The end user has access to key blanks and cuts keys.
- The end user generates and maintains their own key system.
- A signed original Primus Face Sheet and signature card are required initially to set up End User Level systems.
- Every order must include a signed original Face Sheet which is closely checked for an authorized signature. No faxes or photocopies are acceptable due to the ease of forgery.
- The end user can get competitive bids and order End User Level material from any one of a large number of authorized dealers nationwide.

The degree of geographical exclusivity of end user side bitting is determined with the initial order as listed below.

Level 9U (universal)

Fewer than 60 Cylinders. Schlage randomly assigns a side bitting from a small pool of combinations which may be repeated locally. There are no guarantees of geographical exclusivity.

Level 9G (geographical)

More than 60 cylinders. Schlage assigns an exclusive side bitting based on the first two digits of the end user's zip code.

Level 9Z (time zone)

Minimum of 2000 cylinders over two years or pay a fee.
The end user buys exclusivity of one side bitting within a time zone and country.

Level 9N (nationwide)

Minimum of 4000 cylinders over two years or pay a fee.
The end user buys nationwide exclusivity of one side bitting.

Overview for locksmith or security dealer

- These levels are for end users who want to cut their own keys and/or generate their own key system.
- Dealers already selling Level 2 or 8 are authorized to sell Level 9 products.
- Level 1+ and 7 dealers must sign an additional key control contract, but no buy-in is required.
- The degree of geographical exclusivity is determined by the end user's commitment to cylinder volume and separate exclusivity purchases.
- No ID cards are issued at this level.
- All authorization is done with the Primus Face Sheet and Signature Card.
- Schlage requires an original signature on a Primus Face Sheet to process each order.
- Unless Level 9 side bitting is bought outright, Schlage reviews cylinder volume annually and if the contractual commitment is not met, has the option to lower the project to Level 9U and place the side bitting into the Level 9U pool for other end users.

Keyways and keying options

The geographical exclusivity of these levels makes it impractical to illustrate or list all the side bittings. New ones are issued every day around the country.

- Dealers can stock bulk-pack sub-assembled cylinders.
- All cylinders, key and blanks are shipped to the end user's designated location.
- Multi-section keys are available for this level, to accommodate larger systems.
- The last cut of the side bittings at this level is normally shallow (1, 3 or 5) to raise the check pin of conventional Everest cylinders. However, side bittings with a deep last cut are also available at Level 9, provided that the key system will never incorporate conventional cylinders.

Everest D family restricted keyways are also available at Level 9. Use these keyways when patented key control is also required for the conventional (non-Primus) keys on the job.

Schlage does not publish full details on the Everest D family restricted keyways for security reasons. However, the keyway structure is the same as that of the C family keyways.

The Everest D family key section can be cut on Schlage Everest D key punch (40-099) or a rotary key cutting machine.

Key control procedures: dealer controlled systems

Identification cards

The dealer is responsible for stocking ID cards for levels 1, 1+, 2, 7 and 8 and verifying all authorized signatures to issue new keys as key blanks are not permitted to be sold to end users.

The card for each level bears a unique colored stripe, dealer information and a signature panel on the back. When receiving an order for new keys, it is the responsibility of the dealer to verify the signature on the back of the card.

ID Cards (Order in multiples of 50)

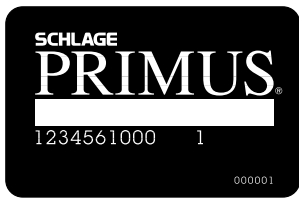

ID Cards (Order in multiples of 50)



Level 1	40-061
Level 1+	40-065
Level 2	40-062
Everest Primus	40-060*

Level 1	40-061-XP
Level 1+	40-065-XP
Level 2	40-062-XP
Everest Primus	40-060-XP*

* Specify level 7 or 8

* Specify level 7 or 8

Restricted key order form

The Restricted Key Order Form is available for no charge and makes the process of tracking keys very easy. If used with a manual credit card machine, the form is able to be imprinted with the numbers embossed on the card and provides space to complete the number of keys requested as well as the key symbol or biting. The end user receives one copy for his records and the dealer retains a copy in his records.

SCHLAGE PRIMUS

WRITE QUANTITY OF KEYS DESIRED	▶	
FURNISH ORIGINAL KEY GROUP SYMBOL, OR, IF UNKNOWN, PROVIDE ACTUAL BITTING OF KEY.	▶	

I hereby authorize the above Schlage dealer to order the exact quantity of RESTRICTED PRIMUS keys that I have indicated and whose code designation is imprinted herein, and I hereby certify that I am the owner, or authorized agent of the owner, of the lock cylinder this specified restricted key operates and I am authorized to place this order.

MS E110 Rev. 9/07 **SCHLAGE**

Primus control register MS-E160

Though not required, dealers should use this form (or create their own form) to track key issues, inaccurate cuts, key blank shipments received and discrepancies.

Issuing ID cards

It is recommended that the dealer consistently use one of the following procedures to issue ID cards to end user customers.

1. Issue a card to each end user or authorized signatory. The end user must keep the card and present it each time a key is requested. Verify the signature with the back of the card and verify the validity of the card in the log book.
2. Issue a card to each end user or authorized signatory. Keep all signed cards in a secure location with the key records. Verify the signature on the back of the card and validity of the card in the log book each time a key is requested.
3. When multiple signatures are required, use the Primus Signature Card. This can be used in addition to or instead of ID cards for the Dealer Levels. **This method should not be used with Level 1 as the end user may request keys from any Level 1 dealer.**

Managing lost, stolen or invalidated cards

Each ID card has a unique serial number in the lower right corner. If a card is reported lost or stolen or a business changes authorized personnel and a previously authorized card holder refuses to surrender a card, the dealer must note in his log that the card is no longer valid to obtain keys.

Card serial number and signature verification should be part of every key authorization.

Managing key blank inventory

It is important to keep an accurate record of key blank inventory and a detailed log of keys issued in case a question arises from an end user or law enforcement agency.

Each incoming order of Primus blanks should be logged with a transaction on a Restricted Key Order Form, signed and dated by the employee who received and counted the blanks.

All inaccurate cuts should also be documented on one of these forms, signed and dated by the employee who handled the transaction and logged into the main book.

The total number of key blanks received, minus inaccurate cuts and keys issued, should always equal the number still on hand. The dealer should reconcile the log periodically and also log and discrepancies at that time. Discrepancies may indicate a breach in security or a careless employee.

Key control procedures: end user controlled systems

Signature verification

Authorization for the end user levels is performed at the Schlage Key Control Center. The dealer is responsible for submitting the end user's signed forms to Schlage with each order.

Primus signature card

The Primus Signature Card is found at the back of this manual and should be used to register each project and its authorized signatories with the factory.

The dealer should complete the form with the end user (job) name, street address and zip code. The zip code is used to maintain the varying degrees of geographical exclusivity offered at the end user levels.

There is space for up to five authorized signatures on the signature card. All signatures will have equal authority to order locks, keys, key blanks and cylinders unless otherwise noted. The signature at the top of the list has authority to add and delete signatures from the card, so it is important that the appropriate person is the top signer.

Primus face sheet form

The Primus Face Sheet form is located in the back of this manual and is required for every Primus or Primus XP factory order.

Levels 3, 4 and 9 are the highest levels of key control. For this reason, no faxed or photocopied signatures will be accepted by the Primus Key Control Center.

It is permissible to fax or photocopy the blank forms in order to speed up the authorization process when the end user has no blank forms. However, once the page is signed it becomes an original and cannot be faxed or photocopied, then submitted for an order.

It is also possible to order a supply of blank forms at no charge using the following form numbers:

Signature Card	MS-E130
Face Sheet	MS-E120

Classic Primus and Classic Primus XP keyways

Level 1 and Level 1+ keyways

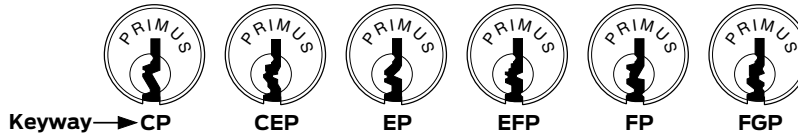

Level 2, 3 and 4 keyways

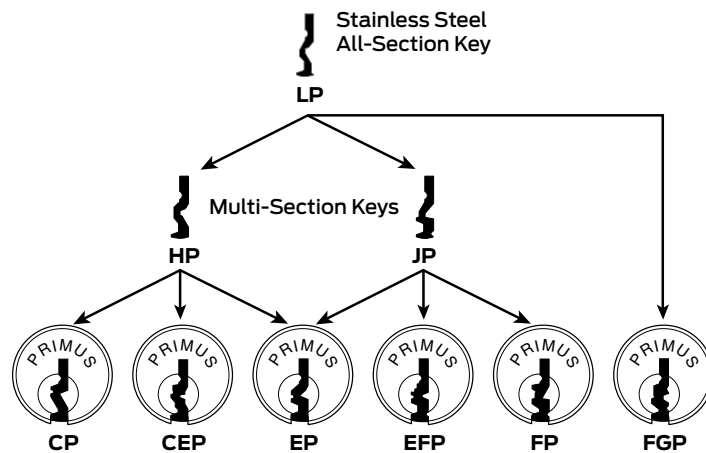

Everest 29 Primus and Everest 29 Primus XP keyways

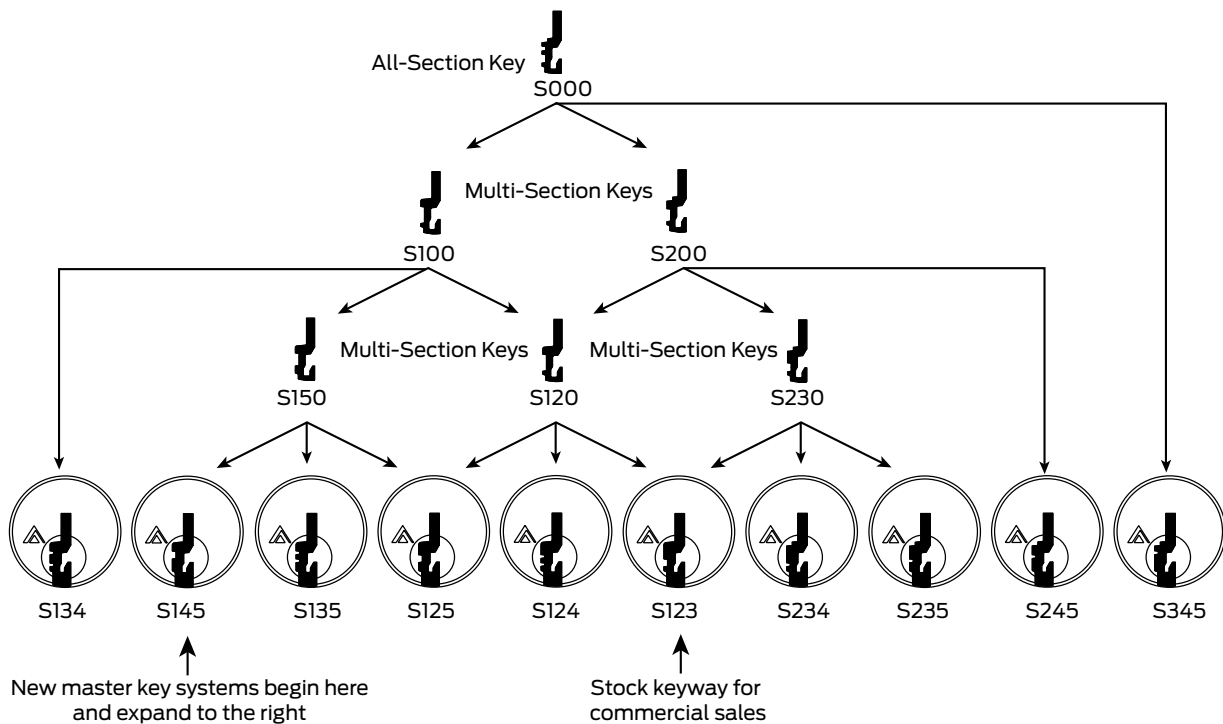

Key-in-knob/key-in-lever cylinders

The part numbers for assembled Classic Primus and Everest Primus cylinders are the same, except for the keyway suffix. To order XP products, add the suffix “-XP” to the end of the complete cylinder number. (Example, “20-793-XP S123” is Everest 29 Primus XP cylinder with a S123 keyway.)

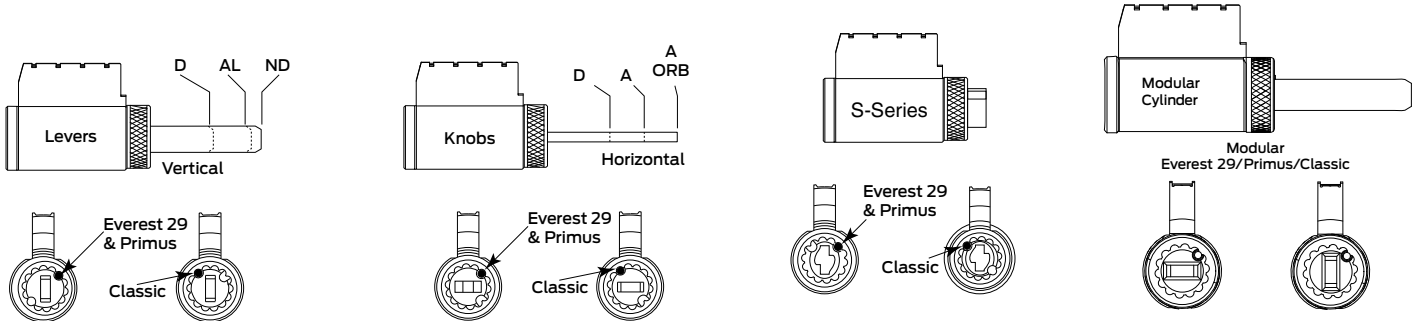

Note: Everest & Primus and Classic cap pin positions are non-modular

Schlage lock sets

Series	Design	Cylinder mechanism	Complete cylinder		Keyway	Tailpiece		Plug	Shell
A, H	Except Orbit	Primus®	20-724		Classic	A301-337		33-136	A508-655
		Primus XP	20-724-XP		Everest 29			33-119	
		Primus UL437	20-524		Classic			33-154	
		Primus XP UL437	20-524-XP		Everest 29			33-221	
A, H	Orbit	Primus	20-724-122		Classic	A301-338		33-136	A508-655
		Primus XP	20-724-122-XP		Everest 29			33-119	
		Primus UL437	20-524-122		Classic			33-154	
		Primus XP UL437	20-524-122-XP		Everest 29			33-221	
AL	All	Primus	20-728		Classic	A700-031		33-136	A508-655
		Primus XP	20-728-XP		Everest 29			33-119	
		Primus UL437	20-528		Classic			33-154	
		Primus XP UL437	20-528-XP		Everest 29			33-221	
D Knobs	All	Primus	Std Door	2-2½" Door	Classic	Std Door	2-2½" Door	33-136	A508-655
		Primus XP	20-748	20-724	Everest 29	C603-524	A301-337	33-119	
		Primus UL437	20-748-XP	20-724-XP	Classic			33-154	
		Primus XP UL437	20-548	20-524	Everest 29			33-221	
			20-548-XP	20-524-XP					
ND Levers	All	Primus	20-765		Classic	N523-022		33-136	A508-655
		Primus XP	20-765-XP		Everest 29			33-119	
		Primus UL437	20-565		Classic			33-154	
		Primus XP UL437	20-565-XP		Everest 29			33-221	
S and S200	All	Primus	20-752		Classic	S605-231		33-136	A508-655
		Primus XP	20-752-XP		Everest 29			33-119	
		Primus UL437	20-552		Classic			33-154	
		Primus XP UL437	20-552-XP		Everest 29			33-221	

Note: For more information on modular cylinders, see page 9.

Key-in-knob/key-in-lever competitive cylinders

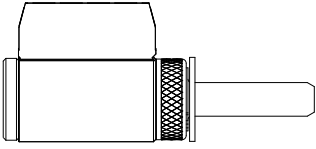
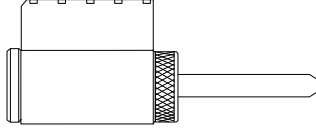
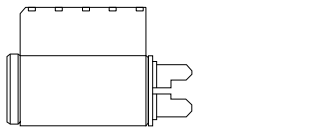
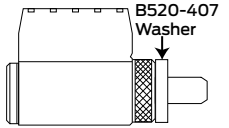
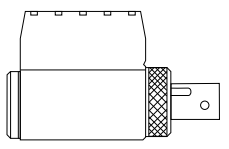
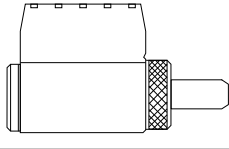
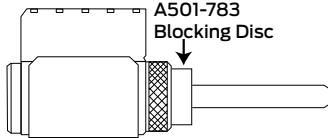
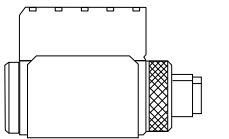
Corbin Russwin cylinders							
Side view	Lock series	Cylinder mechanism	Complete cylinder	Keyway	Tailpiece	Plug	Shell
	CL3300	Primus®	20-762	Classic	N523-022	33-136	A201-683
		Primus XP	20-762-XP	Everest 29		33-119	
		Primus UL437	20-562	Classic		33-154	
		Primus XP UL437	20-562-XP	Everest 29		33-221	
	CL3400, CL3600	Primus	20-739	Classic	A301-338	33-136	A201-683
		Primus XP	20-739-XP	Everest 29		33-119	
		Primus UL437	20-539	Classic		33-154	
		Primus XP UL437	20-539-XP	Everest 29		33-221	
	CK4200, UT5200 (since 1963)	Primus	20-727	Classic	—	33-081	A201-690
		Primus XP	20-727-XP	Everest 29		33-222	
		Primus UL437	20-527	Classic		33-080	
		Primus XP UL437	20-527-XP	Everest 29		33-223	
Sargent cylinders							
	7L, 8L, 10 Line Levers	Primus	20-719	Classic	C604-243	33-163	A201-683
		Primus XP	20-719-XP	Everest 29		33-162	
		Primus UL437	20-519	Classic		33-224	
		Primus XP UL437	20-519-XP	Everest 29		33-225	
	7, 8, 9 Line Knobs	Primus	20-720	Classic	C303-437 Assembly with cap	33-163	A508-637
		Primus XP	20-720-XP	Everest 29		33-162	
		Primus UL437	20-520	Classic		33-224	
		Primus XP UL437	20-520-XP	Everest 29		33-225	
	6 Line, Except B Knob	Primus	20-726	Classic	C604-243	33-163	A508-638
		Primus XP	20-726-XP	Everest 29		33-162	
		Primus UL437	20-526	Classic		33-224	
		Primus XP UL437	20-526-XP	Everest 29		33-225	
Yale cylinders							
	5300LN, 5400LN Levers	Primus	20-747	Classic	A301-043	33-163	A201-683
		Primus XP	20-747-XP	Everest 29		33-162	
		Primus UL437	20-547	Classic		33-224	
		Primus XP UL437	20-547-XP	Everest 29		33-225	
	5300, 5400, 6200 Knobs	Primus	20-723	Classic	B520-409	33-163	A201-683
		Primus XP	20-723-XP	Everest 29		33-162	
		Primus UL437	20-523	Classic		33-224	
		Primus XP UL437	20-523-XP	Everest 29		33-225	

Key-in-knob/key-in-lever cylinders

AD-Series key-in-lever cylinders

AD-Series chassis	Lever style	Cylinder mechanism	Complete cylinder	Keyway	Tailpiece	Plug	Shell
CY	All	Primus®	20-750	Classic	C604-243	33-136	A201-683
		Primus XP	20-750-XP	Everest 29		33-134	
		Primus UL437	20-550	Classic		33-154	
		Primus XP UL437	20-550-XP	Everest 29		33-221	
MS, MD	All	Primus	20-854	Classic	23538085	33-136	A201-683
		Primus XP	20-854-XP	Everest 29		33-134	
		Primus UL437	20-554	Classic		33-154	
		Primus XP UL437	20-554-XP	Everest 29		33-221	
993R, 993S, 993M	ATH, 8AT	Primus	20-750	Classic	C604-243	33-136	A201-683
		Primus XP	20-750-XP	Everest 29		33-134	
		Primus UL437	20-550	Classic		33-154	
		Primus XP UL437	20-550-XP	Everest 29		33-221	
	Except ATH, 8AT	Primus	20-854	Classic	23538085	33-136	A201-683
		Primus XP	20-854-XP	Everest 29		33-136	
		Primus UL437	20-554	Classic		33-154	
		Primus XP UL437	20-554-XP	Everest 29		33-221	





AD-Series competitor cylinder tailpieces



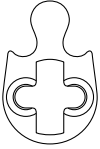

AD-Series chassis	Lever style	Lever cylinder type		Tailpiece
CY	All	Sargent	LD	23433626
		Sargent	JD	23433634
		Corbin Russwin	JD	23433634
		Yale	JD	23433642
MS, MD	All	Sargent	LD	23443427
		Sargent	JD	23443435
		Corbin Russwin	JD	23443435
		Yale	JD	23443443
993R, 993S, 993M	ATH, 8AT	Sargent	LD	23433626
		Sargent	JD	23433634
		Corbin Russwin	JD	23433634
		Yale	JD	23433642
	Except ATH, 8AT	Sargent	LD	23443427
		Sargent	JD	23443435
		Corbin Russwin	JD	23443435
		Yale	JD	23443443

AD-Series Schlage full size cylinder tailpiece



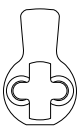





For all chassis types, tailpiece part number: **23446339**.

Mortise cylinders

Schlage L-Series (except L9060 outside)					
Traditional cam			Description	Cylinder mechanism	Complete cylinder
L583-254 Classic	For cylinders prior to July 2010	L583-153 Everest 29 & Primus	Cylinder Only: L & N Escutcheons	Primus Controlled Access	20-793
				Primus UL437	20-593
			Cylinder With Compression Ring and Spring: Rose Trim	Primus Controlled Access	20-787
Modular cam*			Cylinder With Compression Ring and Spring: Rose Trim	Primus UL437	20-587
L583-474**	For modular cylinders introduced July 2010	L583-475***		Primus Lockout	20-717
				Primus UL437 Lockout	20-517

Schlage L9060 outside and other straight cam applications					
Traditional cam			Description	Cylinder mechanism	Complete cylinder
B502-191 Classic	For cylinders prior to July 2010	B502-948 Everest 29 & Primus	Cylinder Only: L & N Escutcheons	Primus Controlled Access	20-701
				Primus UL437	20-501
			Cylinder With Compression Ring and Spring: Rose Trim	Primus Controlled Access	20-700
				Primus UL437	20-500
Modular cam*			Cylinder With Compression Ring and Spring: Rose Trim	Primus Lockout	20-715
L583-476**	For modular cylinders introduced July 2010	L583-477***		Primus UL437 Lockout	20-515
					

Mortise cylinders

Adams Rite MS, 4070, 4500 and 4700 Series, Lori 4500 and Corbin Russwin DL 3000							
Traditional cam			Description		Cylinder mechanism	Complete cylinder	
B502-292 Classic	For cylinders prior to July 2010	B502-944 Everest 29 & Primus	Cylinder with Compression Ring & Spring		Primus Lockout	20-718	
					Primus UL437 Lockout	20-518	
Modular cam*			Cylinder with 3/8" Blocking Ring		Primus Controlled Access	20-706	
L583-446**	For modular cylinders introduced July 2010	L583-447***			Primus UL437	20-506	
							
AR 4070 traditional cam			AR 4070 modular cam*		Cylinder Only	Primus Controlled Access	20-708
B502-380 Classic	For cylinders prior to July 2010	B502-945 Everest 29 & Primus	B520-743**	B520-744***		Primus UL437	20-508
							

* Modular cylinder cams may be used with Classic, Everest and Primus key sections. Use appropriate cam for cylinder housing size.













** For cylinder housing sizes 1 1/8, 1 3/8, 1 5/8"

*** For cylinder housing sizes 1 1/4, 1 1/2, 1 3/4"

NOTE: For more information on modular cylinders, see page 9. To order any of the XP products, add the suffix "-XP" to the end of the complete cylinder number.



Traditional cams are available as parts only and cannot be ordered with complete cylinders.

Schlage Primus mortise cylinder cams to operate other manufacturers' locks

Traditional cams		Modular cams*		Description	
		Sizes 1 1/8, 1 3/8, 1 5/8"	Sizes 1 1/4, 1 1/2, 1 3/4"		
For cylinders prior to July 2010	B520-366 	For modular cylinders introduced July 2010	B520-730 	B520-731 	Corbin Russwin© DL4000 Series (Old Corbin 420 and Russwin 1503) Previously known as XB11-656
	B520-309 		B520-732 	B520-733 	Corbin Russwin© ML2200 Series (Old Corbin 7000-9000 and Russwin 4000-5000) All functions except ML2255 and ML2242 inside Previously known as XB11-629
	B520-367 		B520-734 	B520-735 	Corbin Russwin© A65 ML2200 master ring deadbolt functions manufactured before 6/10/93 and old Russwin cast iron residential Locks Previously known as XB11-887
	B520-329 		B520-736 	B520-737 	Yale© 2160, Arrow© #004, Sargent© 13-0660 (All functions except 16 inside and 50 outside) Previously known as XB11-631

Mortise cylinders

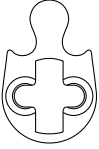
Concealed shell mortise cylinders

Schlage L-Series (except L9060 outside)					
Cams			Description	Cylinder mechanism	Complete cylinder
For cylinders prior to July 2010	L583-254 Classic	L583-153 Everest 29 & Primus	Cylinder Only: L Escutcheon	Primus Controlled Access	20-789
				Primus XP Controlled Access	20-789-XP
				Primus UL437	20-589
				Primus XP UL437	20-589-XP

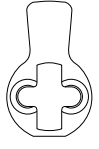
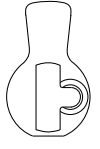
Schlage L9060 outside					
Cams			Description	Cylinder mechanism	Complete cylinder
For cylinders prior to July 2010	B502-191 Classic	B502-948 Everest 29 & Primus	Cylinder Only: L Escutcheon	Primus Controlled Access	24-767
				Primus XP Controlled Access	24-767-XP
				Primus UL437	24-567
				Primus XP UL437	24-567-XP

* Modular cylinder cams may be used with Classic, Everest and Primus key sections. Use appropriate cam for cylinder housing size.

NOTE: For more information on modular cylinders, see page 9.

Traditional cams are available as parts only and cannot be ordered with complete cylinders; however, concealed shell mortise cylinders are the exception to this rule.

Full size interchangeable cores

Mortise full size cylinders

Schlage L-Series (except L9060 outside)			
Cam	Description	Cylinder mechanism	Complete cylinder
	Cylinder with Compression Ring & Spring: L & N Escutcheons	Primus Core	20-798
		Primus XP Core	20-798-XP
	Cylinder with Compression Ring, Spring and 3/8" Blocking Ring: Rose Trim	Primus Core	20-776
		Primus XP Core	20-776-XP

Schlage L9060 outside			
Cam	Description	Cylinder mechanism	Complete cylinder
	Cylinder with Compression Ring & Spring: L & N Escutcheons	Primus Core	20-798
		Primus XP Core	20-798-XP
	Cylinder with Compression Ring, Spring and 3/8" Blocking Ring: Rose Trim	Primus Core	20-776
		Primus XP Core	20-776-XP

Von Duprin, Monarch and other straight cam applications			
Cam	Description	Cylinder mechanism	Complete cylinder
	Cylinder with Compression Ring & Spring	Primus Core	20-763
		Primus XP Core	20-763-XP
	Cylinder with Compression Ring, Spring and 3/8" Blocking Ring	Primus Core	20-771
		Primus XP Core	20-771-XP

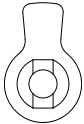
Adams Rite MS, 4070, 4500 and 4700 Series				
Cam	Description		Cylinder mechanism	Complete cylinder
K510-711	B520-378 Adams Rite 4070	Cylinder with Compression Ring, Spring and 3/16" and 3/8" Blocking Rings	Primus Core	20-798
			Primus XP Core	20-798-XP
			Primus Core	20-776
			Primus XP Core	20-776-XP

Full size interchangeable cores

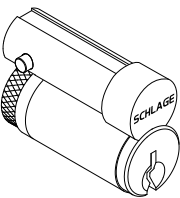
	Description	Part number
	Primus® Core	20-740
	Primus XP Core	20-740-XP
	Primus Core less logo	20-741
	Primus XP Core less logo	20-741-XP

Deadlock cylinders

B700/B800-Series						
Function	Door thickness	Primus® keyway type	Cylinder less housing	Tailpiece	Plug	Shell
B760 B763	1⅜" – 2½"	Classic	20-744	B610-084	33-136	A201-683
		Everest 29				
B760-XP B763-XP		Classic XP	20-744-XP		33-136	
		Everest 29 XP			33-119	
B761 B764	1⅜" – 2"	Classic	20-742	B610-082	33-136	
		Everest 29			33-119	
B761-XP B764-XP		Classic XP	20-742-XP		33-136	
		Everest 29 XP			33-119	
B761 B764	2" – 2½"	Classic	20-743	B610-083	33-136	
		Everest 29			33-119	
B761-XP B764-XP		Classic XP	20-743-XP		33-136	
		Everest 29 XP			33-119	
B762	1⅜" – 2"	Classic	20-745	B610-085	33-136	
		Everest 29			33-119	
B762-XP		Classic XP	20-745-XP		33-136	
		Everest 29 XP			33-119	
B762	2" – 2½"	Classic	20-746	B610-086	33-136	
		Everest 29			33-119	
B762-XP		Classic XP	20-746-XP		33-136	
		Everest 29 XP			33-119	
B860 B863	1⅜" – 2½"	Classic	20-544	B610-084	33-154	
		Everest 29			33-221	
B860-XP B863-XP		Classic XP	20-544-XP		33-154	
		Everest 29 XP			33-221	
B861 B864	1⅜" – 2"	Classic	20-542	B610-082	33-154	
		Everest 29			33-221	
B861-XP B864-XP		Classic XP	20-542-XP		33-154	
		Everest 29 XP			33-221	
B861 B864	2" – 2½"	Classic	20-543	B610-083	33-154	
		Everest 29			33-221	
B861-XP B864-XP		Classic XP	20-543-XP		33-154	
		Everest 29 XP			33-221	
B862	1⅜" – 2"	Classic	20-545	B610-085	33-154	
		Everest 29			33-221	
B862-XP		Classic XP	20-545-XP		33-154	
		Everest 29 XP			33-221	
B862	2" – 2½"	Classic	20-546	B610-086	33-154	
		Everest 29			33-221	
B862-XP		Classic XP	20-546-XP		33-154	
		Everest 29 XP			33-221	

Cabinet lock and portable security cylinders

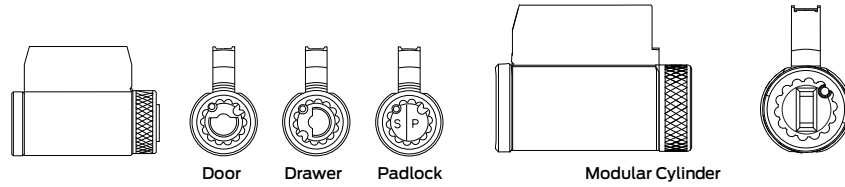

CL-Series cabinet lock cylinders						
Application	Cylinder mechanism	Complete cylinder	Keyway type	Plug	Shell	Actuator
Door	Primus®	20-772	Classic	33-136	A201-683	CL10-360
	Primus XP	20-772-XP	Everest 29	33-119		
	Primus UL437	20-572	Classic	33-154		
	Primus XP UL437	20-572-XP	Everest 29	33-221		
Drawer	Primus	20-774	Classic	33-136	A201-683	
	Primus XP	20-774-XP	Everest 29	33-119		
	Primus UL437	20-574	Classic	33-154		
	Primus XP UL437	20-574-XP	Everest 29	33-221		

KS-Series and KC-Series portable security cylinders						
Series	Cylinder mechanism	Complete cylinder	Keyway type	Plug	Shell	Actuator
KS Series	Primus®	47-743	Classic	33-136	A201-683	KZ32DAO
	Primus XP	47-743-XP	Everest 29	33-119		
	Primus UL437	47-542	Classic	33-154		
	Primus XP UL437	47-542-XP	Everest 29	33-221		
KC Series	Primus	47-744	Classic	33-136	A201-683	KZ34DAO
	Primus XP	47-744-XP	Everest 29	33-119		
	Primus UL437	47-543	Classic	33-154		
	Primus XP UL437	47-543-XP	Everest 29	33-221		

Rim cylinders

Rim cylinders

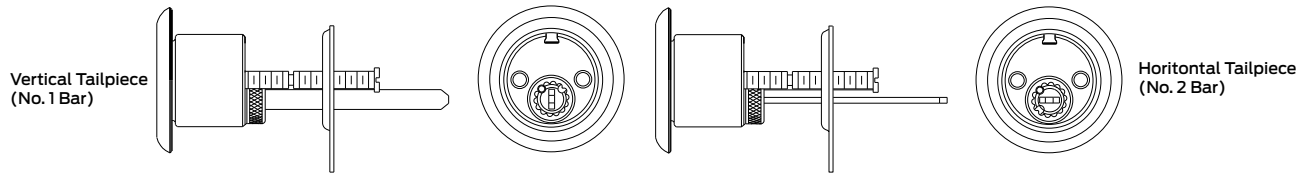

Standard (non-IC) and lockout		
Description	Cylinder mechanism	Complete cylinders
Rim cylinder, vertical tailpiece	Primus	20-709
	Primus UL437	20-509
Rim cylinder, horizontal tailpiece	Primus	20-710
	Primus UL437	20-510
Rim cylinder lockout, horizontal tailpiece	Primus	20-716
	Primus UL437	20-516

Full size IC		
Description	Cylinder mechanism	Part number
Rim Cylinder, convertible tailpiece	Primus Core	20-757
	Primus XP Core	20-757-XP
	Housing less core	20-079
20-757		

Note: To order any of the XP products, add the suffix "-XP" to the end of the complete cylinder number.

Classic Primus keys

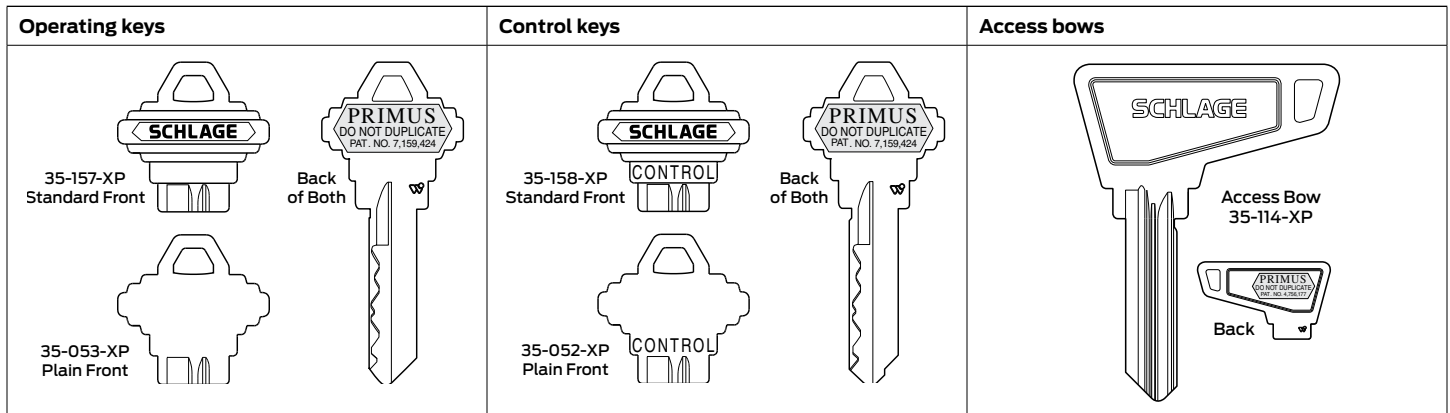

Key blanks	
Part number	Description
35-157-XP	Standard bow, embossed both sides
35-171-XP	Standard bow, stainless steel LP section key
35-158-XP	Control key, standard bow, embossed both sides
35-052-XP	Control key, standard bow, unembossed one side, "PRIMUS" logo on one side
35-115-XP	Large bow, embossed both sides
35-116-XP	Access bow, embossed both sides
35-159-XP	Lockout key, standard bow, embossed both sides

Cut keys	
Part number	Description
48-157-XP	Standard bow, embossed both sides
48-053-XP	Standard bow, unembossed one side, "PRIMUS" logo on one side
48-171-XP	Standard bow, stainless steel LP section key
48-158-XP	Control key, standard bow, embossed both sides
48-052-XP	Control key, standard bow, unembossed one side, "PRIMUS" logo on one side
48-172-XP	Control key, stainless steel LP section control key
48-115-XP	Large bow, embossed both sides
48-116-XP	Access bow, embossed both sides
48-159-XP	Lockout key, standard bow, embossed both sides

Master keys	
Part number	Description
49-157-XP	Standard bow, embossed both sides
49-053-XP	Standard bow, unembossed one side, "PRIMUS" logo on one side
49-171-XP	Standard bow, stainless steel LP section key
49-158-XP	Control key, standard bow, embossed both sides
49-052-XP	Control key, standard bow, unembossed one side, "PRIMUS" logo on one side
49-115-XP	Large bow, embossed both sides
49-116-XP	Access bow, embossed both sides
49-172-XP	Control key, stainless steel LP section control key

Note: To order any of the XP products, add the suffix "-XP" to the end of the complete cylinder number.

Everest Primus keys

Operating keys	Control keys	Back of all keys (except unembossed)
<p>35-004 Standard Front</p> <p>Standard Back</p> <p>35-012 Plain Both Sides</p>	<p>35-005 Standard Front</p> <p>Standard Back</p> <p>35-013 Plain Both Sides</p>	<p>Facility or Dealer ID Number</p> <p>E01426</p> <p>Section</p>

Standard front		Plain both sides		Back of all except	
Everest 29 Primus XP 35-199-XP Operating 35-273-XP		Everest 29 Primus 35-199 Operating 35-273		Everest 29 Primus 35-138 Control 35-215 Operating	
		Everest 29 Primus XP 35-138-XP Control 35-215-XP Operating			Everest 29 Primus XP 35-100-XP 35-273-XP 35-216-XP
					Everest 29 Primus 35-199 35-273 35-216

Key blanks		
Everest 29	Everest	Description
35-199-XP	35-004-XP	6-Pin Standard bow, embossed one side
35-215-XP	35-012-XP	
35-273-XP	35-005-XP	Control Control key, standard bow, embossed one side
35-138-XP	35-013-XP	
35-216-XP	35-006-XP	Lockout Lockout key, standard bow, embossed one side
35-218-XP	35-019-XP	

Cut keys		
Everest 29	Everest	Description
48-199-XP	48-004-XP	6-Pin Standard bow, embossed one side
48-215-XP	48-012-XP	
48-273-XP	48-005-XP	Control Control key, standard bow, embossed one side
48-013-XP	48-020-XP	
48-216-XP	48-006-XP	Lockout Lockout key, standard bow, embossed one side
48-218-XP	48-019-XP	

Master keys		
Everest 29	Everest	Description
49-199-XP	49-004-XP	6-Pin Standard bow, embossed one side
49-215-XP	49-012-XP	
49-273-XP	49-005-XP	Control Control key, standard bow, embossed one side
49-023-XP	49-020-XP	

Note: To order any of the XP products, simply add the suffix "-XP" to the end of the complete cylinder number

Bulk packs

Bulk packs

10-Piece bulk pack key-in-knob/key-in-lever cylinders			
Contents (10 each)	Cylinder mechanism	Keyway type	Bulk pack number
Loaded Shells, Plugs, Caps, Cap Pins, Cap Pin Springs	Primus/Primus XP	Classic	09-833
		Everest 29	09-764

Notes: Specify keyway and finish: 606 or 626. Primus key blanks must be ordered separately.

10-Piece bulk pack mortise cylinders			
Contents (10 each)	Cylinder mechanism	Keyway type	Bulk pack number
Loaded Shells, Plugs, Cam, Screws	Primus/Primus XP	Classic	09-835
		Everest 29	09-767

Notes: Specify keyway, finish: 606 or 626, and 118 or 114 length. Primus key blanks must be ordered separately.

Bulk pack mortise cylinder cam and collars			
Contents (10 each)	Description	Keyway type	Bulk pack number
B502-948 cam	Straight Cam	Classic Primus and Everest 29 Primus	09-761
L583-153 cam	L-Series Cam		09-762
B502-944 cams, 36-079-037 blocking rings, B220-050 set screw packs	Adams Rite Kit		09-763*
36-083, compression ring	Compression rings and springs		09-419

* Specify finish: 605, 606, 612, 613, 625, 626

10-Piece bulk pack rim cylinders			
Contents (10 each)	Cylinder mechanism	Keyway type	Bulk pack number
Loaded Shells, Plugs, Caps, Cap Pins, Collars, Tailpieces, Drivers, Cap Pin Springs, Screws & Back Plate Packs	Primus/Primus XP	Classic	09-834
		Everest 29	09-765

10-Piece bulk pack interchangeable cores			
Contents (10 each)	Cylinder mechanism	Keyway type	Bulk pack number
Loaded Shells, Plugs, Caps, Cap Pins and Springs, Actuating Rings, Actuating Pins, Control Pins	Primus/Primus XP	Classic	09-836
		Everest 29	09-766

Note: To order any of the XP products, add the suffix "-XP" to the end of the complete cylinder number.

Tailpieces

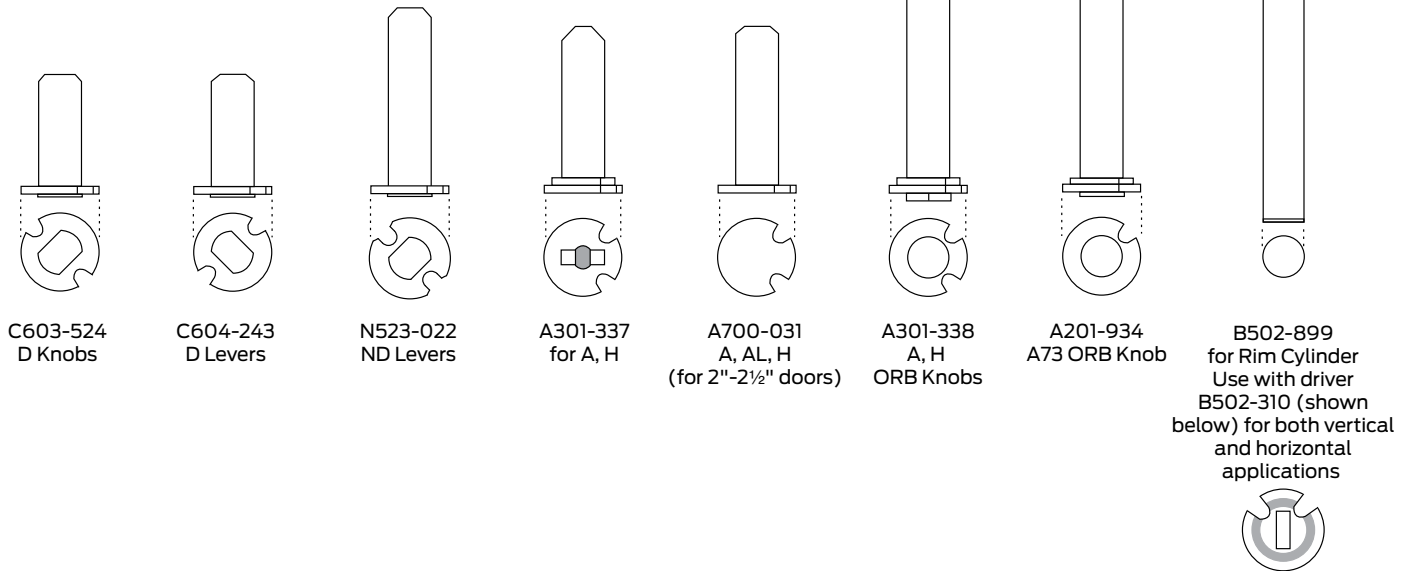
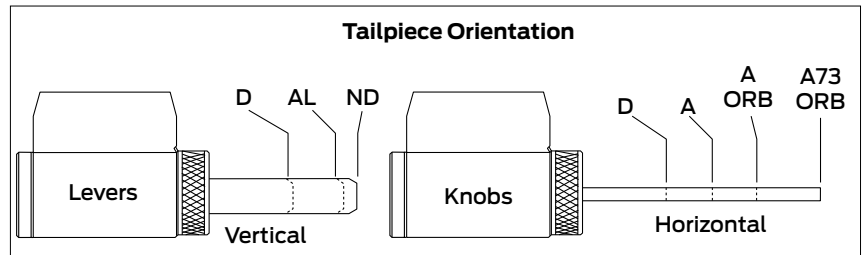
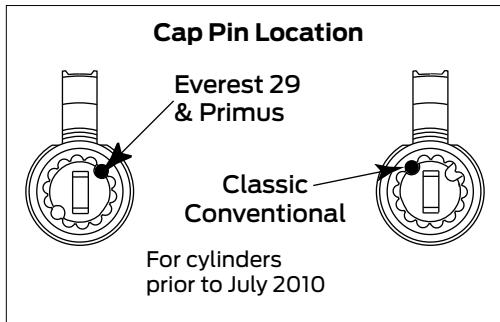

Multiple tailpiece key-in-knob/key-in-lever cylinders

Keyways	Contents	Part number
Primus/Primus XP All Keyways (Classic, Everest, and Everest 29)	(1) Pre-assembled cylinder 0-bitted, less tailpiece and keys	40-700/40-700-XP Controlled Access
	(1) A301-338 tailpiece, A and H-Series Orbit	
	(1) A700-031 tailpiece, AL-Series	
	(1) C604-243 tailpiece, D-Series Levers	
	(1) N523-022 tailpiece, ND-Series Levers (black)	40-500/40-500-XP UL437 Listed
	(2) C503-115 cap pin springs	
	(2) C503-116 cap pins	

Note: Specify keyway and finish: 606 or 626.

Tools and sales support items

Primus® pin kit

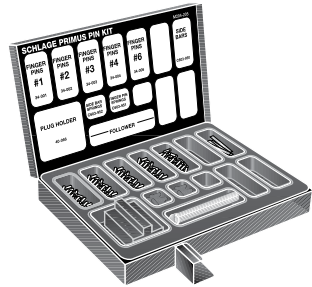

40-070

Contains finger pins, finger pin springs, sidebars, sidebar springs and plug holder (40-066).

Pin kit



40-119

Contains all conventional pins and springs, modular follower M504-548, tweezers and M540-056 cylinder cap removal tool.

Plug holder

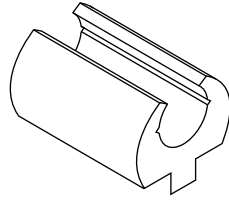

40-066

Has grooves for Primus sidebar. Included in 40-070 finger pin kit.

Key gauge

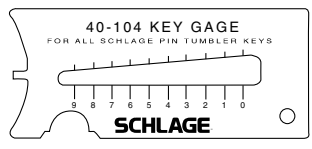

40-104

Key biting punch

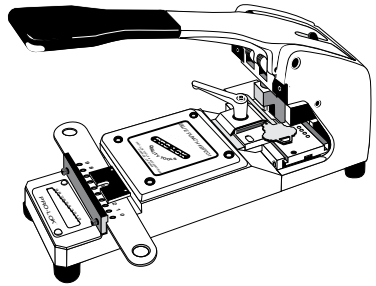

40-075

Blue punch for cutting Obverse and Everest Open C family keys.

Vise jaw upgrade kit



40-074

Replaces jaw on Blue punch key machines manufactured before July 1999 to add Everest C family capability to Obverse family key machines.

ID cards	
Level 1 ID Card	40-061
Level 1+ ID Card	40-065
Level 2 ID Card	40-062
Everest Primus ID	40-060*
Level 1 XP ID Card	40-061-XP
Level 1+ XP ID Card	40-065-XP
Level 2 XP ID Card	40-062-XP
Everest XP Primus ID	40-060-XP*

Forms	
Key Order Form	MS-E110
Primus Control Register	MS-E160
Signature Card	MS-E130
Face Sheet	MS-E120

Other cylinder tools	
Cap Removal Tool	M540-056
Shell Loading Tool	40-116

* Specify Level 7 or 8

Interpreting box labels

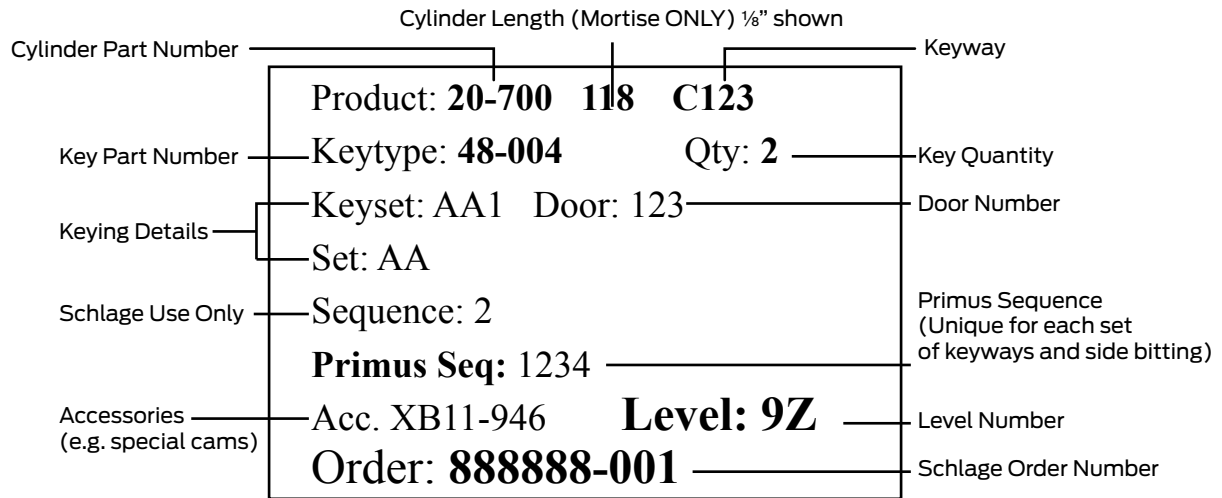

Three parts to key control

How do you account for issued keys? How do you know who has keys to areas of your building or campus? Facilities with proper key control procedures in place know the answers to these questions.

To help facility and security personnel to know who has access to the mechanical locks in their buildings, Schlage offers a three-part solution.

1. Key issue policies

Without a sensible key control policy backed by top management, security can deteriorate quickly. The key control policy should specifically define who may authorize keys to be cut.

Issuing master and grand master keys must be done based on actual need. After all, it does little good to prevent keys from being duplicated externally if many “legitimate” copies of the top master key are issued, increasing risk of loss or theft.

Consider the following ideas which may be utilized (and modified as needed) if deemed appropriate for your facility:

- Establish suitable management levels (department head, shop foreman, etc.) to authorize keys to be cut or issued to employees. Control high level access by requiring higher level approval for master and grand master keys.
- Collect a deposit for all keys issued.
- Require employees to sign a receipt stating that his/her final paycheck will be withheld until all keys are returned. This requires coordination with the Human Resources or Accounting Department.
- Have the key holder or the department manager sign a receipt making them responsible for the cost of rekeying any areas operated by the lost or stolen key.
- Serial number all keys to track multiple copies of the same key issued to different persons. This allows the key control center to trace any key to the rightful key holder.
- Include language on a key receipt that forbids lending of keys to other employees.
- Conduct periodic spot checks to make sure employees have their issued keys.
- Do not store quantities of unused master keys. Destroy them or provide secure storage if necessary.
- Trades, contractors, and maintenance personnel should turn in their master keys at the end of their shifts and pick them up again the next day.
- Enforce adherence to policies with consequences.

2. Track issued keys with SiteMaster 200

Implementing a system to track each and every issued key is critical to provide immediate information about who has access to any given area at any given time. Schlage SiteMaster 200 helps provide this critical information.

SiteMaster 200 has fields for key holder name, key symbol (code), serial number of key, door name, number, etc. Once the data has been entered you can sort it in a variety of ways to produce reports or simply look up an individual person, key, door, etc.

To be effective, one person should be designated responsible for maintaining the database, with backup personnel designated as necessary. Too many people with access to the database can lead to a breakdown in the integrity of the information.

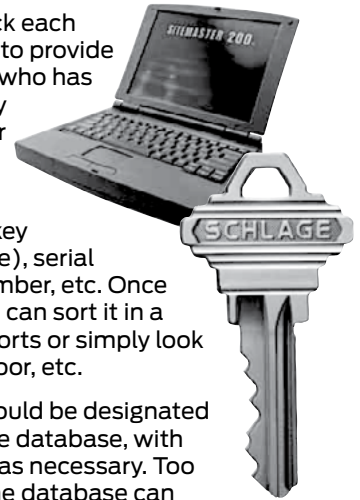

3. Use patented keys

Be sure Parts 1 and 2 are in place.

Install Primus or Everest Primus patented keyways and you can be reasonably sure that your keys won't be copied. It would be difficult, time consuming, and a violation of federal patent law to make an unauthorized copy of a Primus XP or Everest Primus XP key. A person who makes an unauthorized Primus XP or Everest Primus XP key could be subjected to legal action from Schlage.

Ordering Primus

Cylinders

Everest Primus/Everest Primus XP and Classic Primus/Primus XP complete cylinders have the same pricing and part numbers. As with Classic Primus Levels 3 and 4, face sheets are required for Level 9 orders.

To order:

1. Select the Primus cylinder from the cylinder Price Book pages.
2. If a specific keyway is desired, specify the Classic or Everest keyway.
3. Specify keying, finish, cylinder length, or any other fields as necessary.

Example:

How to order a zero-bitted Everest Primus XP non-UL cylinder with a 626 finish and C123 keyway for a D-Series Lever lock:

Step 1: The Primus cylinder part number is 20-750-XP

Step 2: The keyway desired is C123

Step 3: The keying is zero bitted (000000) and the finish desired is 626.

Order: 20-750 626-XP C123-000000

Cylinder bulk packs

All Primus and Primus XP products are available in a Bulk Pack (see Bulk packs on page 37). No signatures or authorizations are required when ordering Bulk Pack Cylinders.

To Order:

1. Choose your Bulk Pack from the Price Book pages based on the cylinder format, finish, and keyway. Check the Express Stock listing for faster delivery.
2. For key-in-knob/lever or mortise cylinders, choose the required tailpieces or cams and collars from the existing Everest Bulk Pack tailpiece, cam and collar offering (Everest, Classic Primus, and Everest Primus all use the same tailpieces).
3. If needed, order a 40-070 Primus pin kit or Primus components.
4. Order keys as needed.

Note: Orders for Level 9 keys must be accompanied by a face sheet.

Primus[®] face sheet



Level 3, 4, and 9 order authorization

**This original form must be mailed to Schlage Commercial Division with your order.
Faxed copies not acceptable**

Distributor information only:

Distributor name _____ Date _____
Account # _____ Distributor PO# _____

Primus security level:

<input type="checkbox"/> 3U (no exclusivity)	<input type="checkbox"/> 4Z (time zone exclusivity)	<input type="checkbox"/> 9U (no exclusivity)	<input type="checkbox"/> 9Z (time zone exclusivity)
<input type="checkbox"/> 3G (2-digit zip exclusivity)	<input type="checkbox"/> 4N (nationwide exclusivity)	<input type="checkbox"/> 9G (2-digit zip exclusivity)	<input type="checkbox"/> 9N (nationwide exclusivity)
Classic keyways		Everest [®] /Everest 29 [™] keyways	

New If new, complete project information and attach Primus' signature card (Schlage form 009160).

Project name (please print or type) _____

Street (no P.O. Box) _____ City _____ State _____ Zip _____

Existing If existing please indicate Primus # _____ (From Primus I.D. Card)

Name and phone# of individual who is knowledgeable about this project, should any clarification be necessary:

Name _____ Phone _____

Shipping instructions:

It is the policy of Schlage Commercial to ship Level 3, 4, and 9 products directly to the end user/owner to maximize control and security of your Primus cylinders and keys. Be sure that the shipping address provided below includes the name of the specific individual in your organization to whom Primus cylinders and keys should be shipped. Schlage will ship to alternate locations, if so instructions, with the understanding that the undersigned assumes full responsibility for the security and care of the material to be so shipped. Unless otherwise specified below, Level 3, 4, and 9 products will be shipped to the original end user/owner address on file.

Masterkeys may be shipped to a separate location if desired, at not extra charge. If all keys are to be packed and shipped separately, there is an additional charge in accordance with Schlage PKI (Pack Keys Independently) pricing as listed in Schlage's current price book.

Order shipping address: _____ Location Name _____ Attention _____ Street (no P.O. Box) _____ City _____ State _____ Zip _____	Change key only shipping address: _____ Location Name _____ Attention _____ Street (no P.O. Box) _____ City _____ State _____ Zip _____
Master key only shipping address: _____ Location Name _____ Attention _____ Street (no P.O. Box) _____ City _____ State _____ Zip _____	All keys shipping address: _____ Location Name _____ Attention _____ Street (no P.O. Box) _____ City _____ State _____ Zip _____

Signature block:

I hereby authorize the above Schlage distributor to order material for the Primus system specified above and I certify that I am the owner, or authorized agent of the owner of the Primus High Security Cylinder system specified above and I am authorized to place this order.

Authorized Signature _____ Date _____

Allegion Security Technologies
Schlage
Attn.: Primus Order Processing
3899 Hancock Expressway
Security, CO 80911

The Primus face sheet must be completed and attached to your order form. An incomplete Primus face sheet will cause unnecessary delays in order processing.

Faxed copies not acceptable.



Primus[®] signature card



Level 3, 4, and 9 order authorization

This signature card establishes authorization to purchase additional primus high security product for the security system installed at the address below.

**This original form must be mailed to Schlage Commercial Division with your order.
Faxed copies not acceptable**

Primus Security Level:

<input type="checkbox"/> 3U (no exclusivity)	<input type="checkbox"/> 4Z (time zone exclusivity)	<input type="checkbox"/> 9U (no exclusivity)	<input type="checkbox"/> 9Z (time zone exclusivity)
<input type="checkbox"/> 3G (2-digit zip exclusivity)	<input type="checkbox"/> 4N (nationwide exclusivity)	<input type="checkbox"/> 9G (2-digit zip exclusivity)	<input type="checkbox"/> 9N (nationwide exclusivity)
Classic keyways		Everest [®] /Everest 29 [™] keyways	

Project information:

Project name (please print or type) _____

Street (no P.O. Box) _____ City _____ State _____ Zip _____

Authorized owner signature(s):

If restrictions are not indicated and in multiple signature cases, the first signature will be regarded as the primary authority able to control other signers on this form.

1. _____ Name	_____	_____	_____
_____	Position/Title	_____	City State Zip
_____	Signature	_____	Date Phone #
2. _____ Name	_____	_____	_____
_____	Position/Title	_____	City State Zip
_____	Signature	_____	Date Phone #
3. _____ Name	_____	_____	_____
_____	Position/Title	_____	City State Zip
_____	Signature	_____	Date Phone #
4. _____ Name	_____	_____	_____
_____	Position/Title	_____	City State Zip
_____	Signature	_____	Date Phone #
5. _____ Name	_____	_____	_____
_____	Position/Title	_____	City State Zip
_____	Signature	_____	Date Phone #

About Allegion

Allegion (NYSE: ALLE) creates peace of mind by pioneering safety and security. As a \$2 billion provider of security solutions for homes and businesses, Allegion employs more than 7,800 people and sells products in more than 120 countries across the world. Allegion comprises 23 global brands, including strategic brands CISA®, Interflex®, LCN®, Schlage® and Von Duprin®.

For more, visit www.allegion.com.

aptiQ ■ LCN ■ **SCHLAGE** ■ STEELCRAFT ■ VON DUPRIN