



PEAKS[®] Preferred/Classic

Technical Manual

KABA[®]

Table of Contents

| | |
|------------------|---|
| Section 1 | Introduction |
| Section 2 | Product Information |
| Section 3 | Key Cutting & Pinning |
| Section 4 | Key Control & Record Keeping |
| Section 5 | Cylinder Installation Guide |

A publication of Kaba Access Control
2941 Indiana Ave.
Winston-Salem, NC 27105

No part of this book may be reproduced or transmitted in any form or by any means, electronic or mechanical, including photocopying, recording, or by any information storage and retrieval system, without prior written permission from the Publisher.

Disclaimer: While reasonable efforts were made to ensure the accuracy of this document at the time of printing, Kaba assumes no liability for any errors or omissions. This information is subject to be revised without notice, and changes may be incorporated in future releases.



PEAKS[®] Preferred/Classic

Technical Manual

Section 1: Introduction



Peaks Preferred/Classic Advantage

- Blanks and cut keys protected by strong, uncontested utility patents
- Patented key control without added expense of UL437
- Retrofits a wide variety of lock brands
- Combines conventional mortise, rim and key-in-knob cylinders, with Best, Arrow, and Falcon interchangeable cores, and Corbin Russwin, Medeco (classic only), Yale, Schlage and Sargent removable cores, all in the same patent protected keying system
- Maximizes use of existing hardware for substantial cost savings
- Cores can be added to existing non-small format interchangeable core systems without loss of keying capacity
- Cylinders resistant to key manipulation for safer master keying
- Keyway families for large institutional end users
- Lowest cost entry into key control market
- Technically simple
- Uses existing key machines
- Distributor supported
- Made in America by world's oldest, largest manufacturer of key control and high security products
- World class factory support

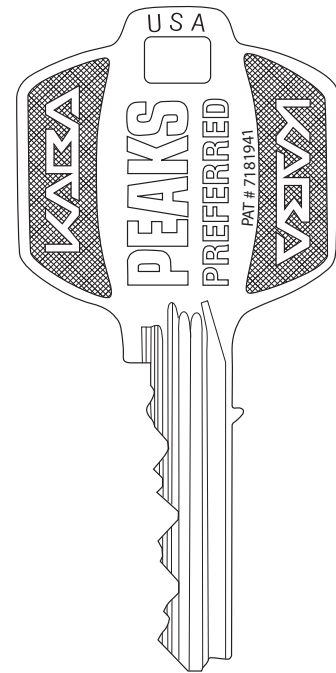

What is Peaks Preferred?

Peaks Preferred is the most cost effective, application flexible, patented end-user key control system available. Two projections near the key bow, called “peaks” are part of the utility patents safeguarding the key blanks. The “peak” operates the patent pin stack. Since the uncut key blank itself is patented, Kaba controls blank manufacture and distribution.

Key Blank Identification Number and Peaks Contracts

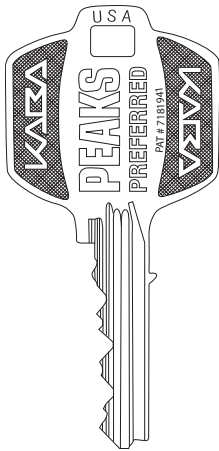

All Peaks key blanks are marked with a unique identification number. The Kaba key control contract and this manual specify certain key control procedures. Breach of contract or failure to abide by factory key records policies can result in loss of the product line.

Contracts specify that:

1. The blank ID number may not be removed, stamped-over, or altered in any way;
2. Parties under contract may not duplicate any keys bearing a blank ID number different from their own;
3. Key blanks may not be sold, lent, or given away;
4. Proper key records must be kept and authorization procedures observed.

The Peaks 140 Family

140 and 150 are the actual pin-to-pin spacings in thousandths of an inch. 140 spacing is used in the interkeyable family of conventional cylinders, interchangeable cores and removable cores. All 140 products are 6-pin. There are actually seven pin stacks in a Peaks 140 core or cylinder. One pin chamber is used for the patent pin stack and is constant in all Peaks products. The remaining six chambers are used for combining.

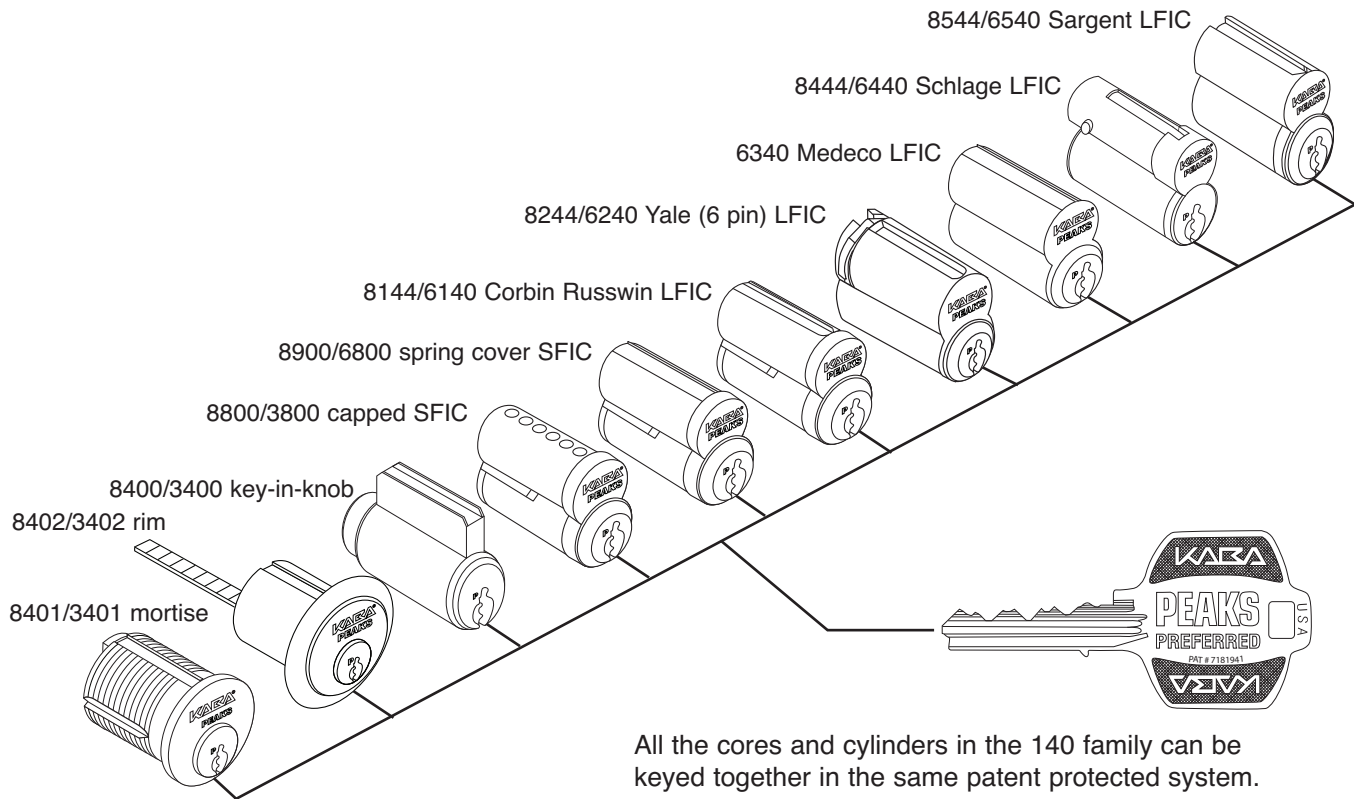

Peaks 150 – Small Format Interchangeable Cores only

150 spacing is used for Peaks small format interchangeable cores only! There are no conventional cylinders or other large format interchangeable cores in 150 spacing. 150 small format interchangeable cores cannot be interkeyed with the 140 family.

The pin-to-pin spacing is 0.150" in original Best small format interchangeable cores. Peaks small format interchangeable cores are available in 6-pin and 7-pin lengths, and will retrofit any Best style housing.

In 150, the first pin chamber is very close to the back. In 140, there is a $\frac{1}{16}$ " gap between the first chamber and the back.

There are seven pin chambers in 6-pin Peaks small format interchangeable cores: six operating pins plus the patent pin, a constant in all cylinders. There are eight pin chambers in 7-pin small format interchangeable cores.

face of Peaks small format interchangeable cores

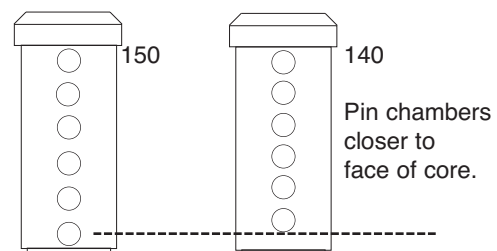

Quick Technical Reference

Increment systems

A2 system: ten depths, numbered 0 to 9, shallow to deep, respectively. The increment of .0125" requires two step progression. Choose a specific parity pattern by using either the odd or even bittings in any given position. The preferred factory standard is A2 system.

A4 system: six depths, numbered 0 to 5, shallow to deep, respectively. The increment of .021" allows for one step progression. *Since there is no parity in A4, all key systems in any keyway are the same.* Kaba strongly suggests the use of A2 system whenever possible.

MACS : use 90 degree cutter

A2 System

140 MACS is 8–09, 90 are forbidden

150 MACS is 9–no forbidden combinations

A4 System

140 MACS is 4–05, 50 are forbidden

150 MACS is 5–no forbidden combinations

Cut next to "peak"

A2 system: #7, 8 or 9 cuts next to the "peak" require #1011 or equivalent cutter.

When master keying, progress this position last.

A4 system: #4 or 5 cuts next to the "peak" require #1011 or equivalent cutter.

When master keying, progress this position last.

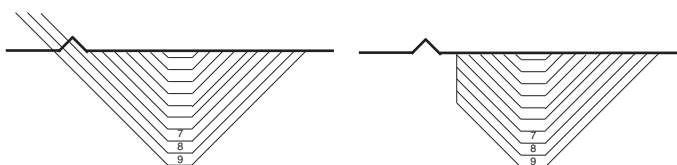

Total pin stack heights

| | small format interchangeable core | mortise/rim | key-in-knob / large format interchangeable core |
|-----------|--------------------------------------|-------------|--|
| A2 system | 23 | 31 | 26 |
| A4 system | 14 | 18 | 15 |

Pinning

The same pins are used for all cylinders and cores, except Corbin Russwin and Sargent large format interchangeable cores and the Universal 8400-xx-1095/1099 and 3400-xx-1095/1099 key-in-knobs, which require the J or K series bottom pins. ***Non-original pins will not work properly in Kaba products and their use voids product warranty.***

All products are top loaded. Capped small format interchangeable cores require the correct capping block (140 or 150). Spring covers are installed with a staking tool and fixture. Combined conventional cylinders may be rekeyed by removing the spring cover or by using a Peaks follower tool and setup key.

Lubrication

Poxylube, a dry spray, is the factory recommended lubricant.

Key Blanks

1. Only keys bearing your unique, factory stamped, Key Blank ID number may be duplicated.
2. Key blanks may not be sold, lent, or given away.
3. Return of key blanks, for any reason, must be made directly to Kaba or to any of the parties as outlined in your contract.

Core marking

Do not stamp the face of the core as the patent pin chamber may collapse. Kaba strongly discourages Visual Key Control (VKC) for security reasons. Concealed Key Control (CKC), such as marking the side of the core with a fine point magic marker, is recommended, and is the factory standard. See section 3–1 for complete marking instructions.

Kaba Access Control

Kaba has provided strong, powerful security solutions since 1862, when German businessman Franz Bauer established a locksmith and safe company named Kassa Bauer (Bauer Safe). Over the past 140 years Kaba has continually increased its capabilities and expanded its vision, becoming a world leader in access control solutions and door hardware.

Today, Kaba's worldwide operations serve millions of customers in more than 150 countries with a comprehensive set of products and services that range from safe locks to access control system integration. More than 7,000 Kaba employees, located in 20 countries are working to maintain the highest levels of customer satisfaction as we continue to grow and expand our vision.

Kaba defines the future of access control as Total Access—the integration of all access control devices, from door hardware to mechanical locking systems, to electronic access systems and data collection. The people of Kaba are committed to leading the access control industry.

Terminology Used in This Manual

Professional industry groups, like the Associated Locksmiths of America (ALOA), the Builders Hardware Manufacturers Association (BHMA), and the Door and Hardware Institute (DHI), work to standardize terminology. This manual conforms to the ALOA publication, *The Professional Glossary of Terms Related to Cylinders, Keys and Master Keying*, hereinafter referred to as the Glossary. It also conforms to the keying symbols of the DHI Keying Manual and BHMA standards. The symbols of the Standard Key Coding System are the industry standard accepted by all lock manufacturers.

Resources

Kaba recommends the following resources:

1. Door and Hardware Institute publications, available from DHI, 14170 Newbrook Drive, Chantilly, VA, 22021. Tel: 703-222-2010
 - Abbreviations and Symbols as used in *Architectural Door and Hardware Schedules and Specifications*
 - Sequence and Format for the Hardware Schedule*
 - Basic Architectural Hardware*
 - Keying Manual*
2. ALOA publication, available from Associated Locksmiths of America, 3003 Live Oak Street, Dallas, TX 75204. Tel: 214-827-1701
 - Fundamentals of Master Keying*

Certain forms used in this manual have been reprinted with permission from *Fundamentals of Master Keying*. You are free to copy the master keying forms at the back of the manual as is, or alter them. There are many other forms available, from site surveys to specialized bitting lists.

3. Kaba Customer Service and Kaba Key Systems are available Monday through Friday, 8:00 a.m. to 5:00 p.m. Eastern Time to answer questions. For Customer Service please call 1-800-849-8324, Ext. 1. For Kaba Key Systems, please call 1-800-849-8324, Ext. 285.

Patents

The primary purpose of patented high security locks is the prevention of unauthorized key duplication. Contracts, factory marked blanks, limited distribution, key records controls, and strong utility patents are essential to state-of-the-art key control.

Fabrication of Peaks Preferred key blanks by anyone other than Kaba is an infringement of utility patent 7.18.1941.

Patent Criteria: A novel mechanical feature on the uncut blank, without which the lock will not operate, is the critical mechanical requirement for a utility patent to protect against unauthorized key duplication.

Kaba Access Control and Kaba Holding AG will bring legal action against any person or persons producing or contributing to the production of unauthorized Peaks keys or key blanks.

Competitive Patents

| Brand | Patent Type | Expires |
|--------------------------------------|----------------|-------------------|
| Medeco KeyMark X4 | utility | 2027 |
| Peaks Preferred | utility | 2024 |
| Schlage Primus XP | utility | 2024 |
| Kaba's Peaks Global | utility | 2023 |
| Assa CLIQ | utility | 2021 |
| Medeco M3 | utility | 2021 |
| Kaba L10 | utility | 2017 |
| Corbin Pyramid | utility | 2017 |
| Assa Twin Pro | utility | 2015 |
| Schlage Everest Primus | utility | July 2014 |
| Arrow Flex Core | utility | July 2012 |
| Sargent Signature | utility | Dec 2012 |
| Kaba Gemini T | utility | Aug 2012 |
| Medeco Keymark | utility | Jan 2011 |
| Kaba's Peaks Classic | utility | June 2010 |
| Assa Twin V-10 | utility | Nov 2008 |
| Kaba Gemini | utility | April 2006 |
| Schlage Primus | utility | July 2005 |
| Medeco Biaxial | utility | expired 2004 |
| Assa Twin 6000 Blank | design | expired 2000 |
| Abloy DiskLock Pro | utility | expired 1999 |
| Medeco Original | utility | expired 1987 |
| Distributor "locksmith" keyways | none | not patented |
| Commonly called "restricted" keyways | none | not patented |

Key Blank Identification Number and Peaks Contracts

All Peaks key blanks are marked with a unique identification number. The Kaba key control contract and this manual specify certain key control procedures. Breach of contract or failure to abide by factory key records policies can result in loss of the product line.

Contracts specify that:

1. The blank ID number may not be removed, stamped-over, or altered in any way;
2. Parties under contract may not duplicate any keys without following proper key records authorization procedures;
3. Key blanks may not be sold, lent, or given away;
4. Proper key records must be kept and authorization forms maintained.

Kaba Peaks Quality

Kaba Access Control employs the latest machining techniques to ensure smooth reliable operation throughout a wide variety of cylinders to provide hardware to fit the full spectrum of security needs. Kaba uses high quality brass to manufacture the plug and shell of each cylinder. All Kaba Peaks keys are made of nickel silver which incorporates a large bow capable of receiving stampings and use by physically impaired people. All Kaba Peaks family of reliable cylinders are designed and manufactured to stand up to the heaviest of use over an extended life of many years.

The patented security features of Kaba's Peaks Security Cylinders provide new capabilities to the standard pin tumbler lock design without complicating the procedures involved in servicing the cylinder. Patent protected Kaba Peaks keys use standard pin tumbler combination bittings, so standard code and duplicating key machines can cut Peaks keys from key blanks that are produced by the factory.



PEAKS[®] Preferred/Classic

Technical Manual

Section 2: Product Information



Conventional Mortise Cylinders—8401/3401 Series

6-pin 140

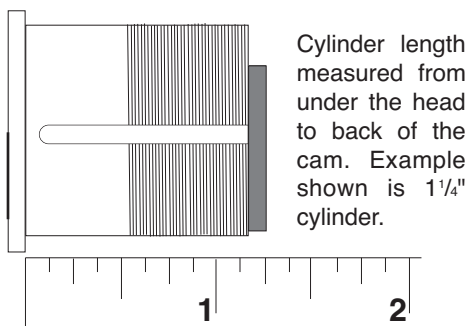

Cylinder length measured from under the head to back of the cam. Example shown is 1 1/4" cylinder.

Conventional mortise cylinders are available in 1 1/8" and 1 1/4" lengths.

Longer length applications can normally be handled by using small format interchangeable core housings.

Collars are not included. Please order collars separately.

Cams for conventional mortise cylinders are attached with 4701-98-4118 Loctite® coated screws. One 3418-00-2000 cam cover is placed over the cam before screws are installed.

If cams are changed in the field, use new screws and tighten them firmly.

Please specify cam when ordering. Contact Kaba about other cam requirements. See bottom of this page for mortise cylinder kit.

Cams shown below are not for small format interchangeable core housings.



3418-00-3000
Corbin Russwin
DL4000
length: 1.080"



3418-00-3001
Adams Rite

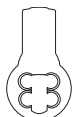

3418-00-3002
Standard



3418-00-3003
Best and
Corbin Russwin
cloverleaf



3418-00-3004
Sargent and Yale
length: 1.010"



3418-00-3008
AR 4070



3418-00-3009
Schlage L



3418-00-3010
Falcon

Mortise Cylinder Kits

mortise cylinder kit, 140 6-pin 1 1/8"

| | |
|--------------|------------------|
| 8401-xx-1038 | uncombined |
| 8401-xx-1238 | factory combined |
| 3401-xx-1038 | uncombined |
| 3401-xx-1238 | factory combined |

xx = Finish

Kit includes: standard, Adams Rite, cloverleaf, Sargent/Yale and Schlage L cams, 5/32" spacer, spare Loctite® coated screws and a cam cover.

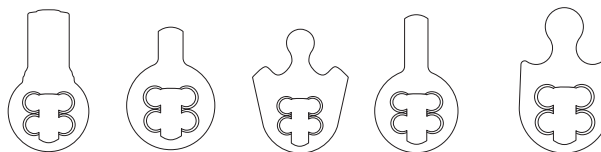
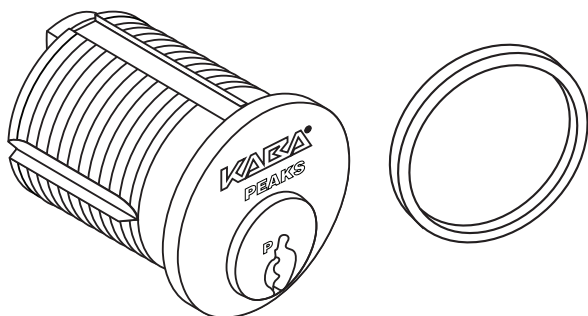

8402-xx-1010
3402-xx-1010
standard
screw hole
locations

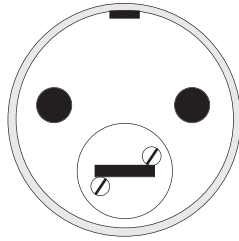

8402-xx-1012
3402-xx-1012
screw holes "high
and outside" for
Sargent exit
devices

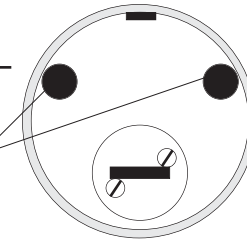

Each 8402/3402 cylinder assembly includes these components:

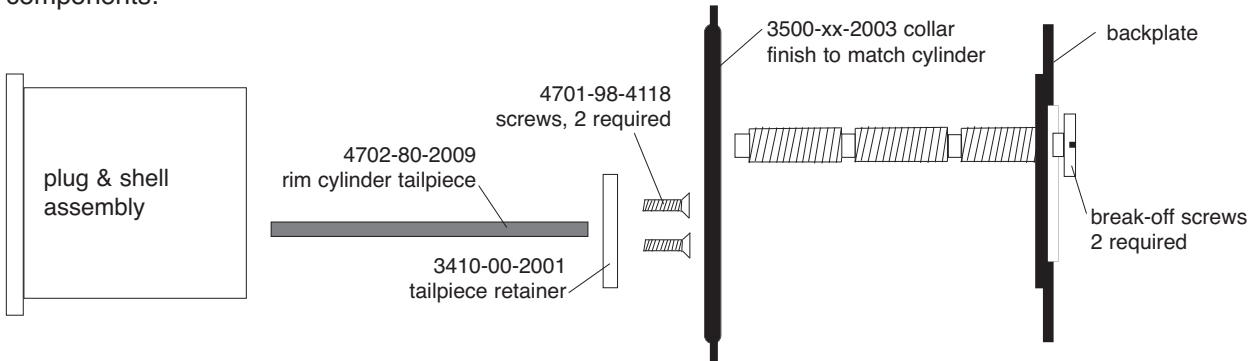

Key-In-Knob Cylinders

Key-in-knob cylinder kit

6-pin 140

Universal cylinder kit for cylindrical and tubular locks ("99" kit)

| | |
|-----------------|------------------|
| 8400-xx-1099 | uncombined |
| 8400-xx-1299-99 | factory combined |
| 3400-xx-1099 | uncombined |
| 3400-xx-1299-99 | factory combined |

xx = Finish

The screw cap plug retainer accepts original tailpiece and driver assemblies by Arrow, Baldwin, Corbin Russwin, Falcon, LSDA, Sargent, Schlage and others. Kit includes a cylinder assembly and one each of the components shown:

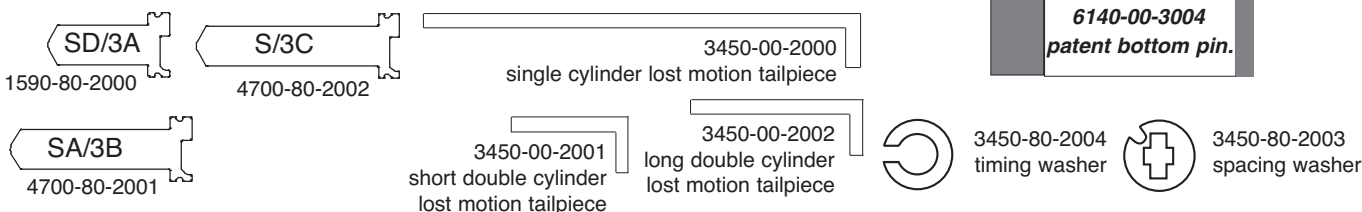

8400 Series
Large diameter plug requires J or K series
bottom pins and 8144-00-3004 patent bottom pin.

3400 Series
Large diameter plug requires J or K series
bottom pins and 6140-00-3004 patent bottom pin.

The Universal "99" cylinder kit can be used with the following lock types. For details, please refer to the specific line drawing of the product.

| Manufacturer | Lock Type | Model # | Manufacturer | Lock Type | Model # |
|----------------|------------------------------|---------|---------------|--------------------------------------|---------|
| Amerock | See Arrow | | Marks | 130 series deadlocks | -01 |
| Arrow | H, L, S and W series | -09 | Marks | 170, 190, 195 series levers | -01 |
| Arrow | M and Q series levers | -09 | Marks | 210 series knobs | -01 |
| Arrow | M series Ball knobs | -20 | Master | ProSeries padlocks | -01 |
| Arrow | Single Cyl. Deadlocks | -90 | New Standard | Brass padlocks | -41 |
| Arrow | Double Cyl. Deadlocks | -92 | | | |
| Cal-Royal | BA grade 2 knobs | -14 | Omnilock | Knob, key by-pass | -17 |
| Cal-Royal | CGN grade 1 levers | -18 | Omnilock | Lever, key by-pass | -18 |
| Cal-Royal | SL grade 2 levers | -18 | PDQ | SK, SP, ST levers | -16 |
| Corbin Russwin | CL3800 | -01 | PDQ | SV grade 2 | -84 |
| Corbin Russwin | CL3300 | -20 | PDQ | Imported grade 1 levers | -23 |
| Corbin Russwin | CL3400 and CL3600 | -11 | Sargent | 5500 Line grade 2 knobs | -14 |
| Corbin Russwin | ED8000-A5/N5 lever trim | -11 | Sargent | 465, 485, 486 single cyl. deadlocks | -90 |
| Falcon | X series knobs, except Hana | -12 | Sargent | 464, 484 double cyl. deadlocks | -92 |
| Falcon | B series grade 2 levers | -18 | Schlage | A series, non-Orbit knobs | -14 |
| Falcon | F series levers | -17 | Schlage | A series, Orbit knobs | -07 |
| Falcon | N series knobs | -17 | Schlage | AL series levers | -20 |
| Falcon | LY grade 1 levers | -23 | Schlage | B single cyl. deadlocks | -90 |
| Falcon | RU grade 1 unit locks | -01 | Schlage | B600, 700, 800 single cyl. deadlocks | -91 |
| Falcon | S series knobs, except Hana | -13 | Schlage | B double cyl. deadlocks | -92 |
| Falcon | S series Hana knobs | -33 | Schlage | B600, 700, 800 double cyl. deadlocks | -93 |
| Falcon | T series levers | -01 | Schlage | C & D series grade 1 knobs | -17 |
| Kaba | 1411 padlocks | -41 | Schlage | C & D series grade 1 levers | -18 |
| LSDA | LS100B, 100P, 100T knobs | -14 | Schlage | S series grade 2 levers | -01 |
| LSDA | LX1000 grade 1 levers (1994) | -18 | Schlage | PL series padlocks | -01 |
| LSDA | LX1000 grade 1 levers (1998) | -18 | Schlage | Old style 45-101 padlocks | -01 |
| LSDA | LH1000 grade 1 knobs | -17 | | | |
| LSDA | L100 grade 2 levers | -18 | Select/Medeco | 2000/All-N-One deadlocks | -01 |
| LSDA | 600 series clutch levers | -18 | Trilogy | 2500 by-pass, knob | -17 |
| LSDA | Single cyl. deadlocks | -90 | Trilogy | 2500 by-pass lever | -18 |
| LSDA | Double cyl. deadlocks | -01 | Ultra | 7000 Ball knob | -18 |
| Marks | 110, 120 series | -14 | Von Duprin | 22 series exit knob trim | -07 |

Key-In-Knob Cylinders

The 8400-xx-1095 and 3400-XX-1095 cylinder kit with small diameter plug face ("95" kit)

| | |
|-----------------|------------------|
| 8400-xx-1095 | uncombined |
| 8400-xx-1295-99 | factory combined |
| 3400-xx-1095 | uncombined |
| 3400-xx-1295-99 | factory combined |

xx = Finish

Falcon applications require Falcon tailpiece kit, Kaba part number 4700-00-5109.

Falcon, Cal-Royal, LSDA, and Weiser deadlocks require OEM tailpieces.

The "95" cylinder kit is used for selected applications which require a small diameter plug face.

The "95" kit includes a cylinder assembly and one each of the components shown:

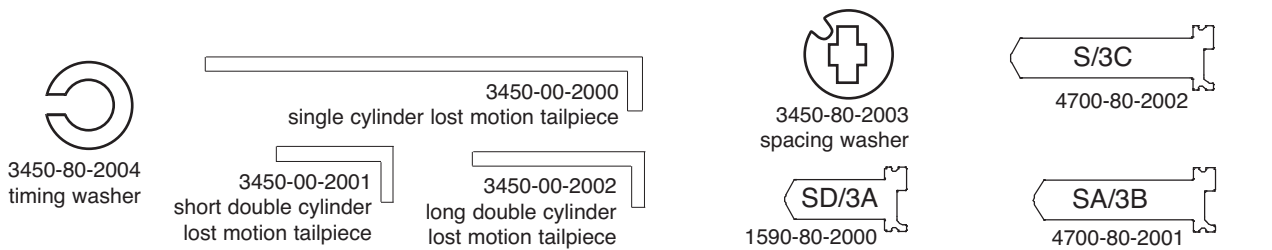

8400 Series
Large diameter
plug requires
J or K series

bottom pins and
8144-00-3004
patent bottom pin.

3400 Series
Large diameter
plug requires
J or K series

bottom pins and
6140-00-3004
patent bottom pin.

The "95" cylinder kit can be used to make the following. For details, please refer to the specific line drawing of the product.

| Manufacturer | Lock Type | Model # | Manufacturer | Lock Type | Model # |
|--------------|---------------------------|---------|--------------|------------------------------|---------|
| Cal-Royal | LSD single cyl. deadlock | -01 | Sargent | 2000 exit device trim | -10 |
| Cal-Royal | LSDD double cyl. deadlock | -01 | Sargent | 6500 Line | -10 |
| Falcon | D series deadlocks | -01 | Weiser | D 9370/9470 series deadlocks | -01 |
| Falcon | X series knobs/unit locks | -21 | Yale | 5300L grade 2 levers | -95 |
| Sargent | 6 Line knobs, except Ball | -10 | Yale | 5300LN grade 2 levers | -56 |
| Sargent | 10 Line levers | -10 | | | |

Key-In-Knob Cylinders

The 8800-xx-1006 and 3400-xx-1006 for Arrow—LSDA—Schlage key-in-knob cylinders (“06” kit)

| | |
|-----------------|------------------|
| 8400-xx-1006 | uncombined |
| 8400-xx-1206-06 | factory combined |
| 3400-xx1006 | uncombined |
| 3400-xx-1206-06 | factory combined |

xx = Finish

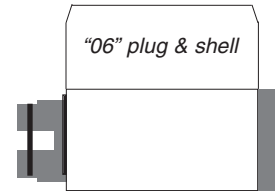

The “06” cylinder also accepts original Arrow, Ilco, Lori, Marks and Sargent fixed tailpieces.
The “06” cylinder kit includes a cylinder assembly and one each of the components shown:



1590-80-2000



4700-80-2001

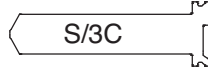

4700-80-2002



3400-00-2009 security bushing

The “06” cylinder kit can be used for the following lock types. For details, please refer to the specific line drawing of the product.

| Manufacturer | Lock Type | Model # | Manufacturer | Lock Type | Model # |
|--------------|-------------------------------|---------|--------------|----------------------|---------|
| American | 3600 and 3700 series padlocks | -01 | Master | System 29 padlocks | 01 |
| Arrow | M series Tudor and Darrin | -26 | Trilogy | 2700 and 3000 levers | -03 |
| Falcon | X series grade 1 Hana Knob | -33 | Master | Pro series | -01 |

Tools

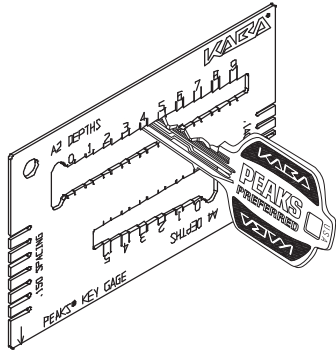

3800-00-4050 Peaks Multi-Gage checks .140" and .150" spacing and depth for the A2 and A4 system.

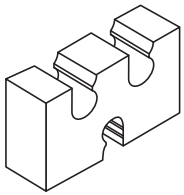

6840-00-3540
staking fixture

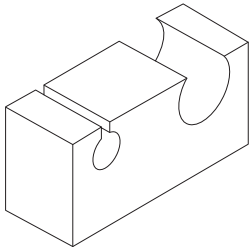

3400-00-4000 staking
fixture for conventionals

6440-00-4001
staking tool



3800-00-3547
capping tool for
both capping
blocks



3800-00-3548
ejector tool

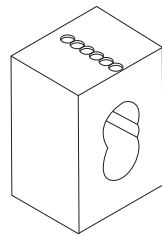

3840-00-3540
140 capping block
(6 holes)

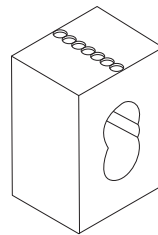

3850-00-3540
150 capping block
(7 holes)

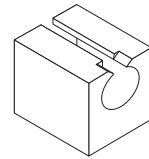

6440-00-3540
staking fixture

AMERICAN Padlocks—see pages 2–23

AMEROCK Same as Arrow retrofits listed below

ARROW *H, L, S & W knobs and levers, Q and M series levers*

| | |
|-----------------|---------------------|
| 8400-xx-1299-09 | factory combined |
| 8400-xx-1099 | uncombined and use* |
| 3400-xx-1299-09 | factory combined |
| 3400-xx-1099 | uncombined and use* |

*1590-80-2000 SD/3A tailpiece, vertical
 *3450-80-2003 spacing washer

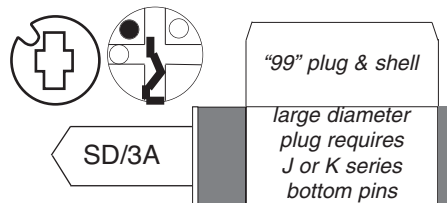

ARROW *M series Tudor and Darrin*

| | |
|-----------------|---------------------|
| 8400-xx-1206-26 | factory combined |
| 8400-xx-1006 | uncombined and use* |
| 3400-xx-1206-26 | factory combined |
| 3400-xx-1006 | uncombined and use* |

*1590-80-2000 SD/3A tailpiece, vertical
 *3400-80-2000 SD/3A tailpiece, vertical

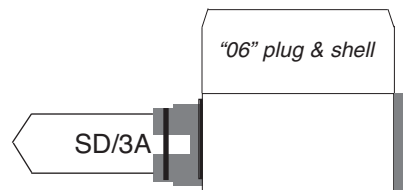

ARROW *M series Ball knobs*

| | |
|-----------------|---------------------|
| 8400-xx-1299-20 | factory combined |
| 8400-xx-1099 | uncombined and use* |
| 3400-xx-1299-20 | factory combined |
| 3400-xx-1099 | uncombined and use* |

*4700-80-2001 SA/3B tailpiece, vertical
 *3450-80-2003 spacing washer

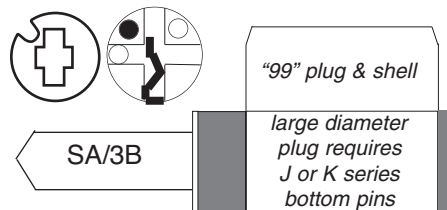

ARROW *Single cylinder deadlocks*

| | |
|-----------------|---------------------|
| 8400-xx-1299-90 | factory combined |
| 8400-xx-1099 | uncombined and use* |
| 3400-xx-1299-90 | factory combined |
| 3400-xx-1099 | uncombined and use* |

*3450-00-2000 lost motion tailpiece
 *3450-80-2004 timing washer

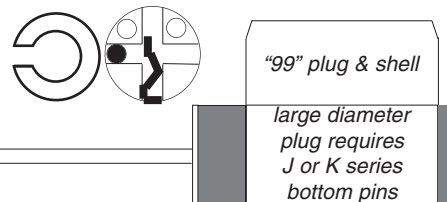

Product Information

Key-In-Knob Cylinders

ARROW

Double cylinder deadlocks

| | |
|-----------------|---------------------|
| 8400-xx-1299-92 | factory combined |
| 8400-xx-1099 | uncombined and use* |
| 3400-xx-1299-92 | factory combined |
| 3400-xx-1099 | uncombined and use* |

*3450-00-2002 long double cylinder lost motion tailpiece standard for 1 $\frac{3}{4}$ " doors

*3450-80-2004 timing washer

*3450-00-2001 short double cylinder lost motion tailpiece included for 1 $\frac{3}{8}$ " doors

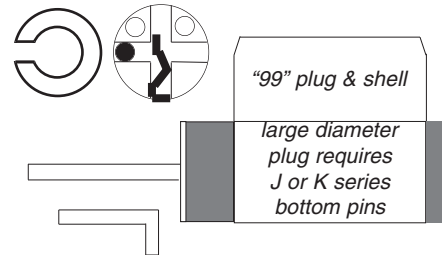

NOTE: File shutter tab slightly on inside cylinder housing to allow clearance for bottom peak.

CAL-ROYAL

BA grade 2 knobs

| | |
|-----------------|---------------------|
| 8400-xx-1299-14 | factory combined |
| 8400-xx-1099 | uncombined and use* |
| 3400-xx-1299-14 | factory combined |
| 3400-xx-1099 | uncombined and use* |

*4700-80-2001 SA/3B tailpiece, horizontal

*3450-80-2003 spacing washer

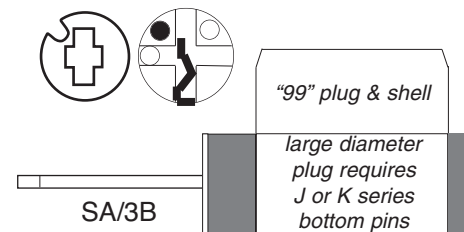

CAL-ROYAL

CGN grade 1 levers and SL grade 2 levers

| | |
|-----------------|---------------------|
| 8400-xx-1299-18 | factory combined |
| 8400-xx-1099 | uncombined and use* |
| 3400-xx-1299-18 | factory combined |
| 3400-xx-1099 | uncombined and use* |

*1590-80-2000 SD/3A tailpiece, vertical

*3450-80-2003 spacing washer

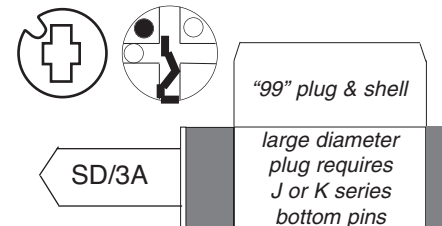

NOTE: Sometimes the drivehole will not accept the Peaks® tailpiece without first filing it narrower top to bottom.

CAL-ROYAL

LSD single cylinder deadlocks LSDD double cylinder deadlocks

| | |
|-----------------|---------------------------|
| 8400-xx-1295-01 | factory combined and use* |
| 8400-xx-1095 | uncombined and use* |
| 3400-xx-1295-01 | factory combined and use* |
| 3400-xx-1095 | uncombined and use* |

*Cal-Royal tailpieces

Cal-Royal tailpieces are not supplied.

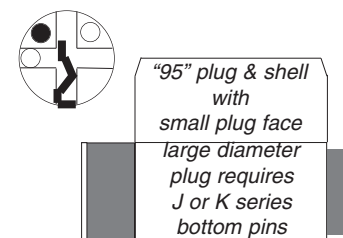

CORBIN RUSSWIN

CK4200 grade 1 knobs, UT5200 Unit locks

| | |
|-----------------|------------------|
| 8400-xx-1204-04 | factory combined |
| 8400-xx-1004 | uncombined |
| 3400-xx-1204-04 | factory combined |
| 3400-xx-1004 | uncombined |

Contact Kaba about applications prior to 1972.

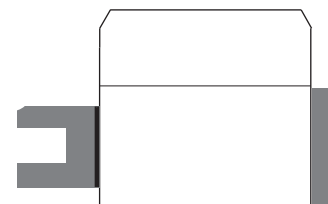

Key-In-Knob Cylinders

**CORBIN
RUSSWIN**

CL3300 grade 1 levers

| | |
|-----------------|---------------------|
| 8400-xx-1299-20 | factory combined |
| 8400-xx-1099 | uncombined and use* |
| 3400-xx-1299-20 | factory combined |
| 3400-xx-1099 | uncombined and use* |

- *4700-80-2001 SA/3B tailpiece, vertical
- *3450-80-2003 spacing washer or, the original
- *Corbin Russwin tailpiece may be used.

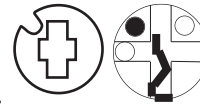

"99" plug & shell

large diameter
plug requires
J or K series
bottom pins

NOTE: Not for use on G3 exit trim.

**CORBIN
RUSSWIN**

**CL3400, CL3600 grade 1 levers,
Lever trim A5, N5 for ED8000 exit devices**

| | |
|-----------------|---------------------|
| 8400-xx-1299-11 | factory combined |
| 8400-xx-1099 | uncombined and use* |
| 3400-xx-1299-11 | factory combined |
| 3400-xx-1099 | uncombined and use* |

- *4700-80-2002 S/3C tailpiece, vertical
- *3450-80-2003 spacing washer

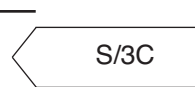
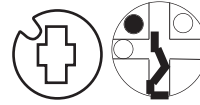

"99" plug & shell

large diameter
plug requires
J or K series
bottom pins

If spacer supplied by Corbin Russwin is missing, substitute Kaba 3400-00-2009 security bushing.

**CORBIN
RUSSWIN**

CL3800 grade 2 levers

| | |
|-----------------|---------------------|
| 8400-xx-1299-01 | factory combined |
| 8400-xx-1099 | uncombined and use* |
| 3400-xx-1299-01 | factory combined |
| 3400-xx-1099 | uncombined and use* |

- *the original Corbin Russwin tailpiece and plastic tailpiece bushing

Corbin Russwin tailpiece and bushing not supplied.



"99" plug & shell

large diameter
plug requires
J or K series
bottom pins

**CORBIN
RUSSWIN**

CL3900 grade 2 levers

| | |
|-----------------|------------------|
| 8400-xx-1255-55 | factory combined |
| 8400-xx-1055 | uncombined |
| 3400-xx-1255-55 | factory combined |
| 3400-xx-1055 | uncombined |

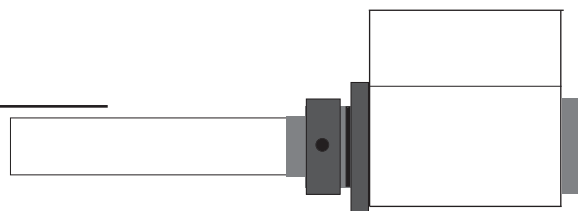

FALCON

B Series grade 2 levers

| | |
|-----------------|---------------------|
| 8400-xx-1299-18 | factory combined |
| 8400-xx-1099 | uncombined and use* |
| 3400-xx-1299-18 | factory combined |
| 3400-xx-1099 | uncombined and use* |

- *1590-80-2000 SD/3A tailpiece, vertical
- *3450-80-2003 spacing washer

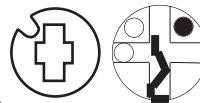

"99" plug & shell

large diameter
plug requires
J or K series
bottom pins

Key-In-Knob Cylinders

FALCON

D Series deadlocks

| | |
|-----------------|---------------------|
| 8400-xx-1295-01 | factory combined |
| 8400-xx-1095 | uncombined and use* |
| 3400-xx-1295-01 | factory combined |
| 3400-xx-1095 | uncombined and use* |



"95" plug & shell
with
small plug face
large diameter
plug requires
J or K series
bottom pins

Single cylinder functions:

*Falcon TP-10 tailpiece (A28350-000-00)
and retainer TPR-4 (A08385-000-00)

or

Double cylinder functions:

*Falcon TP-9 tailpiece (A24350-007-00)
and retainer TPR-2 (A14351-000-00)

Use Falcon tailpiece, not supplied.

FALCON

F Series levers & N Series knobs

| | |
|-----------------|---------------------|
| 8400-xx-1299-17 | factory combined |
| 8400-xx-1099 | uncombined and use* |
| 3400-xx-1299-17 | factory combined |
| 3400-xx-1099 | uncombined and use* |

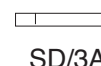
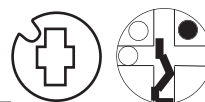

SD/3A

"99" plug & shell
large diameter
plug requires
J or K series
bottom pins

*1590-80-2000 SD/3A tailpiece, horizontal
*3450-80-2003 spacing washer

FALCON

LY grade 1 levers (same as early model imported PDQ lever)

| | |
|-----------------|---------------------|
| 8400-xx-1299-23 | factory combined |
| 8400-xx-1099 | uncombined and use* |
| 3400-xx-1299-23 | factory combined |
| 3400-xx-1099 | uncombined and use* |

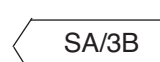

SA/3B

"99" plug & shell
large diameter
plug requires
J or K series
bottom pins

*4700-80-2001 SA/3B tailpiece, vertical
*3450-80-2003 spacing washer
*two 4700-00-4007 metal washers, tailpiece



FALCON

RU Series grade 1 Unit lock

| | |
|-----------------|------------------|
| 8400-xx-1299-01 | factory combined |
| 8400-xx-1099 | uncombined* |
| 3400-xx-1299-01 | factory combined |
| 3400-xx-1099 | uncombined* |



"99" plug & shell
large diameter
plug requires
J or K series
bottom pins

*Use Falcon parts
*Install Falcon driver and tailpiece.

Most functions use Falcon no. 030730-001-30
RU 381 inside cylinder only use Falcon no. 030730-003-30
RU571 only use Falcon no. 030730-005-30

Falcon parts are not supplied.

Key-In-Knob Cylinders

FALCON

S Series grade 2 knobs, except Hana

| | |
|-----------------|---------------------|
| 8400-xx-1299-13 | factory combined |
| 8400-xx-1099 | uncombined and use* |
| 3400-xx-1299-13 | factory combined |
| 3400-xx-1099 | uncombined and use* |

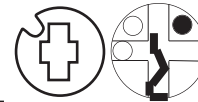

"99" plug & shell

large diameter
plug requires
J or K series
bottom pins

*4700-80-2004 FS tailpiece, horizontal

*3450-80-2003 spacing washer

Or, use original Falcon tailpiece TP-2 or TP-3 with Falcon retainer TPR-1 may be used.

FALCON

S Series grade 2, Hana knobs

| | |
|-----------------|---------------------|
| 8400-xx-1299-33 | factory combined |
| 8400-xx-1099 | uncombined and use* |
| 3400-xx-1299-33 | factory combined |
| 3400-xx-1099 | uncombined and use* |

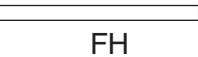
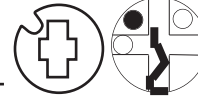

"99" plug & shell

large diameter
plug requires
J or K series
bottom pins

*4700-80-2006 FH tailpiece, horizontal

*3450-80-2003 spacing washer

Or, use Falcon tailpiece TP-3 or TP-4 with Falcon retainer TPR-1.

FALCON

T Series, grade 1 levers

| | |
|-----------------|---------------------|
| 8400-xx-1299-01 | factory combined |
| 8400-xx-1099 | uncombined and use* |
| 3400-xx-1299-01 | factory combined |
| 3400-xx-1099 | uncombined and use* |



"99" plug & shell

large diameter
plug requires
J or K series
bottom pins

*Most functions use Falcon no. 030730-001-30

*T381 inside cylinder only use Falcon no. 030730-003-30

*T571 only use Falcon no. 030730-005-30

Falcon parts are not supplied.

FALCON

X Series grade 1 knobs, except Hana

| | |
|-----------------|---------------------|
| 8400-xx-1299-12 | factory combined |
| 8400-xx-1099 | uncombined and use* |
| 3400-xx-1299-12 | factory combined |
| 3400-xx-1099 | uncombined and use* |

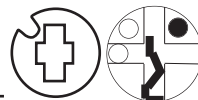

"99" plug & shell

large diameter
plug requires
J or K series
bottom pins

*4700-80-2003 FX tailpiece, horizontal

*3450-80-2003 spacing washer

Or, use Falcon tailpiece TP-1, TP-3, or TP-5 with Falcon retainer TPR-1.

Falcon parts are not supplied.

FALCON

X Series grade 1, Hana knobs

| | |
|-----------------|------------------|
| 8400-xx-1206-33 | factory combined |
| 8400-xx-1006 | uncombined* |
| 3400-xx-1206-33 | factory combined |
| 3400-xx-1006 | uncombined* |

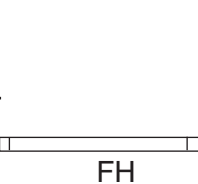

"06" plug & shell

*4700-80-2006 FH tailpiece, horizontal

*3450-80-2003 Spacing Washer

Or, use Falcon TP-2, TP-4 or TP-6 with retainer TPR-1

Falcon parts are not supplied.

***NOTE:** When ordering cylinder uncombined, FH tailpiece must be requested.

***NOTE:** When replacing 7-pin Falcon cylinder, a 6-pin Falcon cylinder spacer must be used.

Key-In-Knob Cylinders

FALCON

Older X Series grade 1 knobs and unit locks with one-piece (capless) knobs and knob hole bushings

| | |
|-----------------|---------------------|
| 8400-xx-1295-21 | factory combined |
| 8400-xx-1095 | uncombined and use* |
| 3400-xx-1295-21 | factory combined |
| 3400-xx-1095 | uncombined and use* |

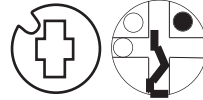

"95" plug & shell
with
small plug face
large diameter
plug requires
J or K series
bottom pins

- *3450-80-2003 spacing washer
- *use existing tailpiece from Falcon cylinder, horizontal.

NOTE: If Falcon tailpiece needs replacement, Kaba FX tailpiece (4700-80-2003) can be used, but must be ordered separately.

KABA

1411 padlock

| | |
|-----------------|----------------------|
| 8400-xx-1299-41 | factory combined |
| 8400-xx-1099 | uncombined* and use* |
| 3400-xx-1299-41 | factory combined |
| 3400-xx-1099 | uncombined* and use* |

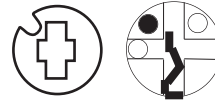

"99" plug & shell
large diameter
plug requires
J or K series
bottom pins

- *1410-82-2000 P tailpiece horizontal
- *3450-80-2003 spacing washer

***NOTE:** When ordering cylinder uncombined, P tailpiece must be requested.

LSDA

LH1000 grade 1 knobs

| | |
|-----------------|---------------------|
| 8400-xx-1299-17 | factory combined |
| 8400-xx-1099 | uncombined and use* |
| 3400-xx-1299-17 | factory combined |
| 3400-xx-1099 | uncombined and use* |

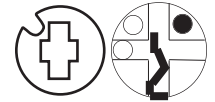

"99" plug & shell
large diameter
plug requires
J or K series
bottom pins

- *1590-80-2000 SD/3A tailpiece, horizontal
- *3450-80-2003 spacing washer

SD/3A

LSDA

LX1000 grade 1 levers, L100 grade 2 levers, 600 series 'clutch' lever (1998)

| | |
|-----------------|---------------------|
| 8400-xx-1299-18 | factory combined |
| 8400-xx-1099 | uncombined and use* |
| 3400-xx-1299-18 | factory combined |
| 3400-xx-1099 | uncombined and use* |

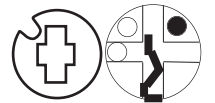

"99" plug & shell
large diameter
plug requires
J or K series
bottom pins

- *1590-80-2000 SD/3A tailpiece, vertical
- *3450-80-2003 spacing washer

SD/3A

Key-In-Knob Cylinders

LSDA

LX1000 grade 1 levers (prior to 1994)

Field modification required.

| | |
|-----------------|---------------------|
| 8400-xx-1299-18 | factory combined |
| 8400-xx-1099 | uncombined and use* |
| 3400-xx-1299-18 | factory combined |
| 3400-xx-1099 | uncombined and use* |

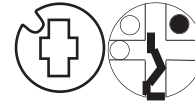

cut away
SD/3A
cut away

"99" plug & shell

large diameter
plug requires
J or K series
bottom pins

*3450-80-2003 spacing washer

*1590-80-2000 SD/3A tailpiece, vertical, modified as shown

LSDA

(LS)100B, 100P and 100T grade 2 knobs

| | |
|-----------------|---------------------|
| 8400-xx-1299-14 | factory combined |
| 8400-xx-1099 | uncombined and use* |
| 3400-xx-1299-14 | factory combined |
| 3400-xx-1099 | uncombined and use* |

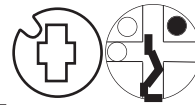

SA/3B

"99" plug & shell

large diameter
plug requires
J or K series
bottom pins

*4700-80-2001 SA/3B tailpiece, horizontal

*3450-80-2003 spacing washer

LSDA

Single cylinder deadlocks

| | |
|-----------------|---------------------|
| 8400-xx-1299-90 | factory combined |
| 8400-xx-1099 | uncombined and use* |
| 3400-xx-1299-90 | factory combined |
| 3400-xx-1099 | uncombined and use* |

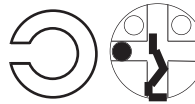

"99" plug & shell

large diameter
plug requires
J or K series
bottom pins

*3450-00-2000 lost motion tailpiece

*3450-80-2004 timing washer

Or, use LSDA tailpiece and driver.

LSDA

Double cylinder deadlocks

| | |
|-----------------|---------------------|
| 8400-xx-1299-01 | factory combined |
| 8400-xx-1099 | uncombined and use* |
| 3400-xx-1299-01 | factory combined |
| 3400-xx-1099 | uncombined and use* |

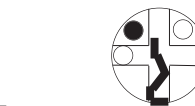

"99" plug & shell

large diameter
plug requires
J or K series
bottom pins

*LSDA tailpiece assembly.

LSDA double cylinder tailpiece assembly not supplied.

Key-In-Knob Cylinders

MARKS

110, 120 Series cylindrical locks

| | |
|-----------------|---------------------|
| 8400-xx-1299-14 | factory combined |
| 8400-xx-1099 | uncombined and use* |
| 3400-xx-1299-14 | factory combined |
| 3400-xx-1099 | uncombined and use* |

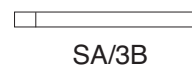
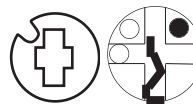

SA/3B

"99" plug & shell

large diameter
plug requires
J or K series
bottom pins

*4700-80-2001 SA/3B tailpiece, horizontal

*3450-80-2003 spacing washer

MARKS

130 Series deadlocks

| | |
|-----------------|---------------------------|
| 8400-xx-1299-01 | factory combined and use* |
| 8400-xx-1099 | uncombined and use* |
| 3400-xx-1299-01 | factory combined and use* |
| 3400-xx-1099 | uncombined and use* |



"99" plug & shell

large diameter
plug requires
J or K series
bottom pins

*Mark's tailpieces

1³/₈" to 1¹/₂" door: Marks tailpiece 1353-L

1⁵/₈" to 1⁷/₈" door: Marks tailpiece 1354-L

2" to 2¹/₄" door: Marks tailpiece 1355-L

Marks tailpieces are not supplied.

MARKS

170, 190, 195 Series levers, 210 Series knobs

| | |
|-----------------|---------------------------|
| 8400-xx-1299-01 | factory combined and use* |
| 8400-xx-1099 | uncombined and use* |
| 3400-xx-1299-01 | factory combined and use* |
| 3400-xx-1099 | uncombined and use* |



"99" plug & shell

large diameter
plug requires
J or K series
bottom pins

*Mark's tailpieces

All functions except DA, DC, S: Marks tailpiece A1903-C (C9)

Functions DA, DC, S: Marks tailpiece A1903S-C (SC9)

Marks tailpieces are not supplied.

MASTER

Padlocks—see page 2–23

NEW STANDARD

Brass padlock—See Kaba 1411 padlock page 2–23

OMNILOCK

Knob, key by-pass

| | |
|-----------------|---------------------|
| 8400-xx-1299-17 | factory combined |
| 8400-xx-1099 | uncombined and use* |
| 3400-xx-1299-17 | factory combined |
| 3400-xx-1099 | uncombined and use* |

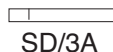
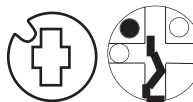

SD/3A

"99" plug & shell

large diameter
plug requires
J or K series
bottom pins

*1590-80-2000 SD/3A tailpiece, horizontal

*3450-80-2003 spacing washer

Key-In-Knob Cylinders

OMNILOCK *Lever, key by-pass*

| | |
|-----------------|---------------------|
| 8400-xx-1299-18 | factory combined |
| 8400-xx-1099 | uncombined and use* |
| 3400-xx-1299-18 | factory combined |
| 3400-xx-1099 | uncombined and use* |

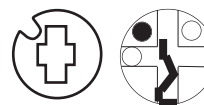

SD/3A

"99" plug & shell

large diameter
plug requires
J or K series
bottom pins

*1590-80-2000 SD/3A tailpiece, vertical

*3450-80-2003 spacing washer

PDQ *SK, SP & ST levers (U.S.A.)*

| | |
|-----------------|---------------------|
| 8400-xx-1299-16 | factory combined |
| 8400-xx-1099 | uncombined and use* |
| 3400-xx-1299-16 | factory combined |
| 3400-xx-1099 | uncombined and use* |

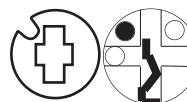

S/3C

"99" plug & shell

large diameter
plug requires
J or K series
bottom pins

*4700-80-2002 S/3C tailpiece, vertical

*3450-80-2003 spacing washer

PDQ *Imported SV grade 2 knobs using Ilco 7056 or Lori 1539 cylinders and 3A or SV tailpieces*

| | |
|-----------------|---------------------|
| 8400-xx-1299-84 | factory combined |
| 8400-xx-1099 | uncombined and use* |
| 3400-xx-1299-84 | factory combined |
| 3400-xx-1099 | uncombined and use* |

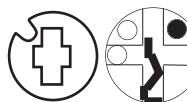

SD/3A

"99" plug & shell

large diameter
plug requires
J or K series
bottom pins

*1590-80-2000 SD/3A tailpiece, horizontal

*3450-80-2003 spacing washer

*two 4700-00-4007 metal washers, tailpiece



PDQ *Imported grade 1 Levers (prior to U.S.A. Spirit Levers)*

| | |
|-----------------|---------------------|
| 8400-xx-1299-23 | factory combined |
| 8400-xx-1099 | uncombined and use* |
| 3400-xx-1299-23 | factory combined |
| 3400-xx-1099 | uncombined and use* |

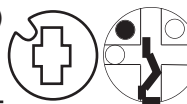

SA/3B

"99" plug & shell

large diameter
plug requires
J or K series
bottom pins

*4700-80-2001 SA/3B tailpiece, vertical

*3450-80-2003 spacing washer

*two 4700-00-4007 metal washers, tailpiece



Key-In-Knob Cylinders

SARGENT

10+ Line levers, 2000 exit device trim

| | |
|-----------------|---------------------|
| 8400-xx-1295-10 | factory combined |
| 8400-xx-1095 | uncombined and use* |
| 3400-xx-1295-10 | factory combined |
| 3400-xx-1095 | uncombined and use* |

- *4700-00-4008 neoprene washer
- *1590-80-2000 SD/3A tailpiece, vertical
- *3450-80-2003 spacing washer

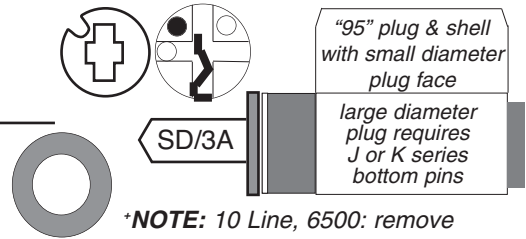

***NOTE:** 10 Line, 6500: remove Sargent nylon or plastic spindle bushing and place washer #4700-00-4008 over tailpiece before installing cylinder.

SARGENT

6 Line grade 2 Ball knobs

| | |
|-----------------|---------------------|
| 8400-xx-1210-65 | factory combined |
| 8400-xx-1010 | uncombined and use* |
| 3400-xx-1210-65 | factory combined |
| 3400-xx-1010 | uncombined and use* |

- *4700-80-2001 SA/3B tailpiece, vertical
- *3400-00-2009 spacing washer

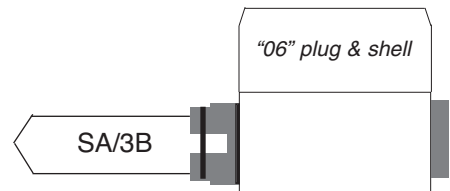

SARGENT

5500 Line imported grade 2 knobs

| | |
|-----------------|---------------------|
| 8400-xx-1299-14 | factory combined |
| 8400-xx-1099 | uncombined and use* |
| 3400-xx-1299-14 | factory combined |
| 3400-xx-1099 | uncombined and use* |

- *4700-80-2001 SA/3B tailpiece, horizontal
- *3450-80-2003 spacing washer

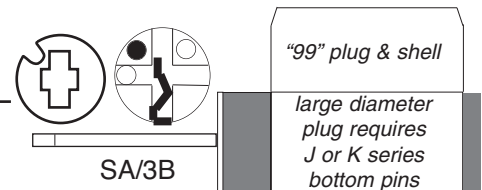

SARGENT

7, 8 & 9 Line grade 1 knobs

| | |
|-----------------|---------------------|
| 8400-xx-1208-08 | factory combined |
| 8400-xx-1008 | uncombined and use* |
| 3400-xx-1208-08 | factory combined |
| 3400-xx-1008 | uncombined and use* |

- *3440-00-5108 adapter assembly

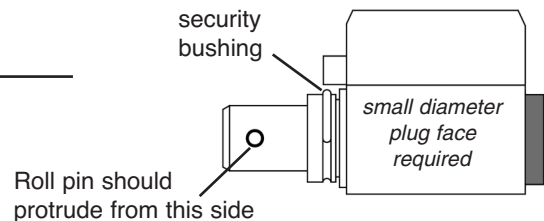

SARGENT

465, 485, 486 single cylinder deadlocks

| | |
|-----------------|---------------------|
| 8400-xx-1299-90 | factory combined |
| 8400-xx-1099 | uncombined and use* |
| 3400-xx-1299-90 | factory combined |
| 3400-xx-1099 | uncombined and use* |

- *3450-00-2000 lost motion tailpiece
- *3450-80-2004 timing washer

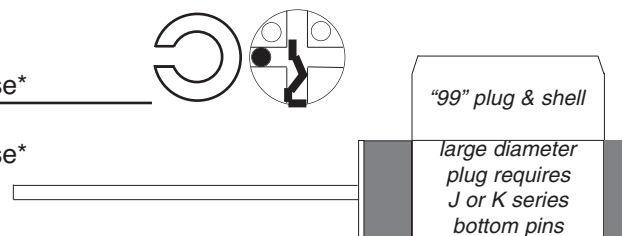

Key-In-Knob Cylinders

SARGENT

464, 484 double cylinder deadlocks

| | |
|-----------------|---------------------|
| 8400-xx-1299-92 | factory combined |
| 8400-xx-1099 | uncombined and use* |
| 3400-xx-1299-92 | factory combined |
| 3400-xx-1099 | uncombined and use* |

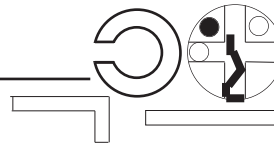

"99" plug & shell

large diameter
plug requires
J or K series
bottom pins

- *3450-00-2002 long double cylinder lost motion tailpiece standard for 1 $\frac{3}{4}$ " thick doors
- *3450-80-2004 timing washer
- *3450-00-2001 short double cylinder lost motion tailpiece included for 1 $\frac{3}{8}$ " thick doors

NOTE: Slightly file shutter tab on inside cylinder housing to allow clearance for bottom peak.

SARGENT

7600 Series Integralock

| | |
|-----------------|------------------|
| 8400-xx-1276-76 | factory combined |
| 8400-xx-1076 | uncombined |
| 3400-xx-1276-76 | factory combined |
| 3400-xx-1076 | uncombined |

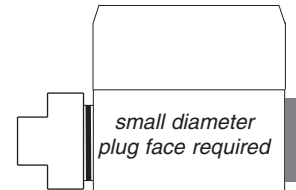

small diameter
plug face required

SCHLAGE

A Series, grade 2 non-Orbit knobs

| | |
|-----------------|---------------------|
| 8400-xx-1299-14 | factory combined |
| 8400-xx-1099 | uncombined and use* |
| 3400-xx-1299-14 | factory combined |
| 3400-xx-1099 | uncombined and use* |

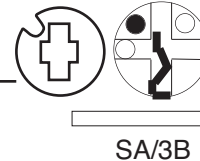

SA/3B

"99" plug & shell

large diameter
plug requires
J or K series
bottom pins

- *4700-80-2001 SA/3B tailpiece, horizontal
- *3450-80-2003 spacing washer

SCHLAGE

A Series, grade 2 Orbit knob

| | |
|-----------------|---------------------|
| 8400-xx-1299-07 | factory combined |
| 8400-xx-1099 | uncombined and use* |
| 3400-xx-1299-07 | factory combined |
| 3400-xx-1099 | uncombined and use* |

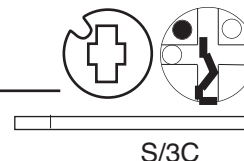

S/3C

"99" plug & shell

large diameter
plug requires
J or K series
bottom pins

- *4700-80-2002 S/3C tailpiece, horizontal
- *3450-80-2003 spacing washer

SCHLAGE

AL Series grade 2 levers

| | |
|-----------------|---------------------|
| 8400-xx-1299-20 | factory combined |
| 8400-xx-1099 | uncombined and use* |
| 3400-xx-1299-20 | factory combined |
| 3400-xx-1099 | uncombined and use* |

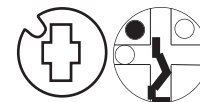

SA/3B

"99" plug & shell

large diameter
plug requires
J or K series
bottom pins

- *4700-80-2001 SA/3B tailpiece, vertical
- *3450-80-2003 spacing washer

Key-In-Knob Cylinders

SCHLAGE *B100, B400 E, EB, F160, MD single cylinder deadlocks, S200 and H locksets*

| | |
|-----------------|---------------------|
| 8400-xx-1299-90 | factory combined |
| 8400-xx-1099 | uncombined and use* |
| 3400-xx-1299-90 | factory combined |
| 3400-xx-1099 | uncombined and use* |

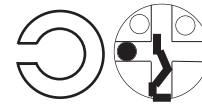

"99" plug & shell

large diameter
plug requires
J or K series
bottom pins

- *3450-00-2000 lost motion tailpiece
- *3450-80-2004 timing washer

SCHLAGE *B100, B400, E, EB, Fi60 and MD double cylinder deadlocks*

| | |
|-----------------|---------------------|
| 8400-xx-1299-92 | factory combined |
| 8400-xx-1099 | uncombined and use* |
| 3400-xx-1299-92 | factory combined |
| 3400-xx-1099 | uncombined and use* |

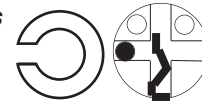

"99" plug & shell

large diameter
plug requires
J or K series
bottom pins

- *3450-80-2004 timing washer
- *3450-00-2002 long double cylinder lost motion tailpiece for 1³/₄" thick doors or
- *3450-00-2001 short double cylinder lost motion tailpiece for 1³/₈" thick doors

SCHLAGE *B600, B700 and B800 single cylinder deadlocks*

| | |
|-----------------|---------------------|
| 8400-xx-1299-91 | factory combined |
| 8400-xx-1099 | uncombined and use* |
| 3400-xx-1299-91 | factory combined |
| 3400-xx-1099 | uncombined and use* |

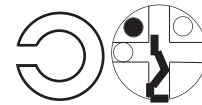

"99" plug & shell

large diameter
plug requires
J or K series
bottom pins

- *3450-00-2000 lost motion tailpiece
- *3450-80-2004 timing washer

SCHLAGE *B600, B700 and B800 double cylinder deadlocks,*

| | |
|-----------------|---------------------|
| 8400-xx-1299-93 | factory combined |
| 8400-xx-1099 | uncombined and use* |
| 3400-xx-1299-93 | factory combined |
| 3400-xx-1099 | uncombined and use* |

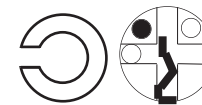

"99" plug & shell

large diameter
plug requires
J or K series
bottom pins

- *3450-80-2004 timing washer
- *3450-00-2002 long double cylinder lost motion tailpiece for 1³/₄" thick doors or
- *3450-00-2001 short double cylinder lost motion tailpiece for 1³/₈" thick doors

SCHLAGE *C & D Series grade 1 knobs*

| | |
|-----------------|---------------------|
| 8400-xx-1299-17 | factory combined |
| 8400-xx-1099 | uncombined and use* |
| 3400-xx-1299-17 | factory combined |
| 3400-xx-1099 | uncombined and use* |

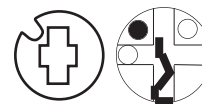

"99" plug & shell

large diameter
plug requires
J or K series
bottom pins

- *1590-80-2000 SD/3A tailpiece, horizontal
- *3450-80-2003 spacing washer

SD/3A

Key-In-Knob Cylinders

SCHLAGE

C & D Series, and Vandlgard grade 1 levers

| | |
|-----------------|---------------------|
| 8400-xx-1299-18 | factory combined |
| 8400-xx-1099 | uncombined and use* |
| 3400-xx-1299-18 | factory combined |
| 3400-xx-1099 | uncombined and use* |

- *1590-80-2000 SD/3A tailpiece, vertical
- *3450-80-2003 spacing washer

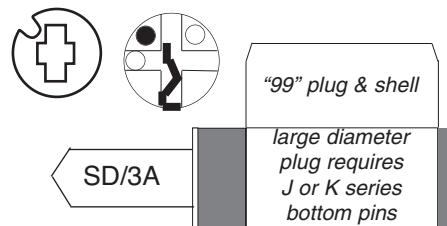

SCHLAGE

S Series grade 2 levers

| | |
|-----------------|---------------------|
| 8400-xx-1299-01 | factory combined |
| 8400-xx-1099 | uncombined and use* |
| 3400-xx-1299-01 | factory combined |
| 3400-xx-1099 | uncombined and use* |

- *Schlage S series driver S605-228
- *Schlage cylinder sleeve S605-192

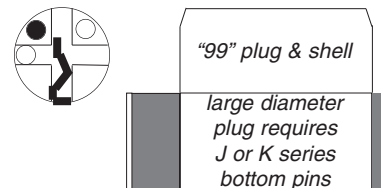

Schlage parts are not supplied.

SELECT or MEDECO

2000 Series deadlocks All-N-One deadlocks

| | |
|-----------------|---------------------|
| 8400-xx-1299-01 | factory combined |
| 8400-xx-1099 | uncombined and use* |
| 3400-xx-1299-01 | factory combined |
| 3400-xx-1099 | uncombined and use* |

- *No attachments.

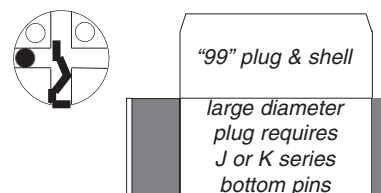

TRILOGY

2700, 3000 levers

| | |
|-----------------|---------------------|
| 8400-xx-1206-03 | factory combined |
| 8400-xx-1006 | uncombined and use* |
| 3400-xx-1206-03 | factory combined |
| 3400-xx-1006 | uncombined and use* |

- *4700-80-2005 E tailpiece, vertical
- *3400-00-4008 security washer, plug

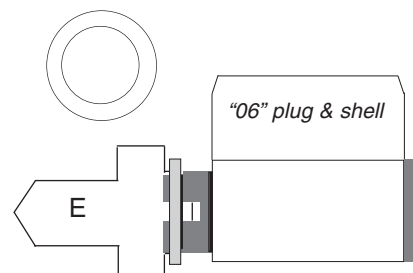

TRILOGY

2500 bypass, knob designs prior to 5-97

| | |
|-----------------|---------------------|
| 8400-xx-1299-17 | factory combined |
| 8400-xx-1099 | uncombined and use* |
| 3400-xx-1299-17 | factory combined |
| 3400-xx-1099 | uncombined and use* |

- *1590-80-2000 SD/3A tailpiece, horizontal
- *3450-80-2003 spacing washer

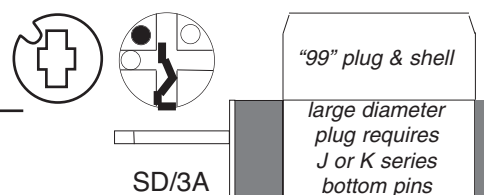

Key-In-Knob Cylinders

TRILOGY

2500 bypass, lever designs prior to 5-97

| | |
|-----------------|---------------------|
| 8400-xx-1299-18 | factory combined |
| 8400-xx-1099 | uncombined and use* |
| 3400-xx-1299-18 | factory combined |
| 3400-xx-1099 | uncombined and use* |

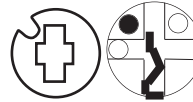

SD/3A

"99" plug & shell

large diameter
plug requires
J or K series
bottom pins

*1590-80-2000 SD/3A tailpiece, vertical

*3450-80-2003 spacing washer

ULTRA

7000 Ball knob

| | |
|-----------------|---------------------|
| 8400-xx-1299-18 | factory combined |
| 8400-xx-1099 | uncombined and use* |
| 3400-xx-1299-18 | factory combined |
| 3400-xx-1099 | uncombined and use* |

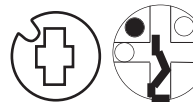

SD/3A

"99" plug & shell

large diameter
plug requires
J or K series
bottom pins

*1590-80-2000 SD/3A tailpiece, vertical

*3450-80-2003 spacing washer

WEISER

D 9370 and 9470 series deadlocks

| | |
|-----------------|---------------------|
| 8400-xx-1295-01 | factory combined |
| 8400-xx-1095 | uncombined and use* |
| 3400-xx-1295-01 | factory combined |
| 3400-xx-1095 | uncombined and use* |



"95" plug & shell
with
small plug face
large diameter
plug requires
J or K series
bottom pins

*Weiser tailpiece and retainer.

Weiser parts are not supplied.

VON DUPRIN 22 Series exit device knob trim

| | |
|-----------------|---------------------|
| 8400-xx-1299-07 | factory combined |
| 8400-xx-1099 | uncombined and use* |
| 3400-xx-1299-07 | factory combined |
| 3400-xx-1099 | uncombined and use* |

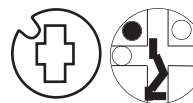

S/3C

"99" plug & shell

large diameter
plug requires
J or K series
bottom pins

*4700-80-2002 S/3C tailpiece, horizontal

*3450-80-2003 spacing washer over tailpiece

Key-In-Knob Cylinders

YALE

6100 and 6200 series Monolocks

Retrofit for Yale No. 1801 cylinder

8400-xx-1255 (Yale monolock) factory combined

8400-xx-1055 (Yale monolock) uncombined

3400-xx-1255 (Yale monolock) factory combined

3400-xx-1055 (Yale monolock) uncombined

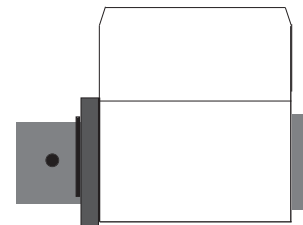

Same as 8400-xx-1054-54 cylinder below, but without rollpin and spacer.

YALE

5400 grade 1 knobs and 5300 grade 2 knobs

Retrofit for Yale No. 1801 cylinder

8400-xx-1254-54 factory combined

8400-xx-1054 uncombined

3400-xx-1254-54 factory combined

3400-xx-1054 uncombined

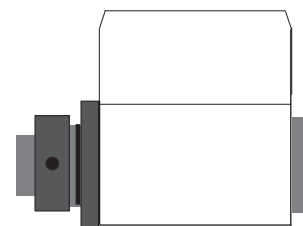

Same as 8400-xx-1055-55 cylinder below, but without tailpiece.

YALE

5400LN grade 1 levers

8400-xx-1255-55 factory combined

8400-xx-1055 uncombined and use*

3400-xx-1255-55 factory combined

3400-xx-1055 uncombined and use*

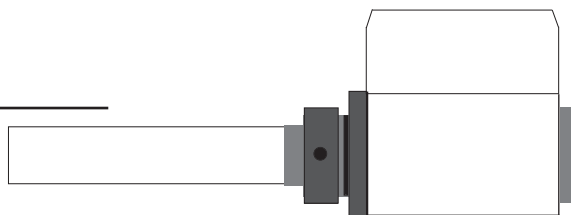

*3425-82-3012 tailpiece

*3425-00-4012 retainer pin (1/16" roll pin)

Same as 8400-xx-1054 cylinder above but with tailpiece.

YALE

5300L grade 2 levers

8400-xx-1295-95 factory combined then modify

8400-xx-1095 uncombined and use*

3400-xx-1295-95 factory combined then modify

3400-xx-1095 uncombined and use*

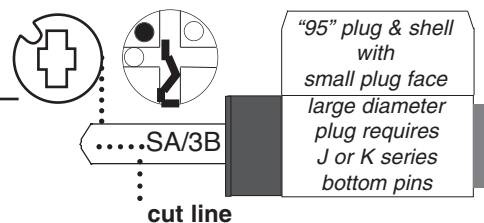

*4700-80-2001 SA/3B tailpiece, vertical

*3450-80-2003 spacing washer

Field modification required.

Note: Modify tailpiece using Yale tailpiece as a template.

YALE

5300LN grade 2 levers

8400-xx-1295-56 factory combined

8400-xx-1095 uncombined and use*

3400-xx-1295-56 factory combined

3400-xx-1095 uncombined and use*

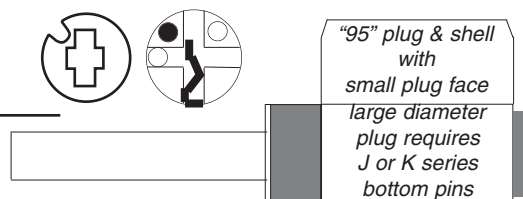

*3450-80-2003 spacing washer

*3450-00-2000 lost motion tailpiece, vertical

Padlocks—Key-in-Knob Cylinders

6-pin 140

Kaba 1411 or New Standard

| | |
|-----------------|--------------------------------|
| 8400-xx-1299-41 | factory combined |
| 8400-xx-1099 | cylinder with Kaba P tailpiece |
| 3400-xx-1299-41 | factory combined |
| 3400-xx-1099 | cylinder with Kaba P tailpiece |

The following can be made from 8400-xx-1099 or 3400-xx-1099 cylinder kit using OEM drivers:

Master ProSeries—Use adapter #0298-0628 from Master.

| | |
|-----------------|------------------|
| 8400-xx-1299-01 | factory combined |
| 3400-xx-1299-01 | factory combined |

Schlage PL series—Use padlock driver from Schlage.

| | |
|-----------------|------------------|
| 8400-xx-1299-01 | factory combined |
| 3400-xx-1299-01 | factory combined |

Schlage old style 45-101—Use padlock driver from Schlage.

| | |
|-----------------|------------------|
| 8400-xx-1299-01 | factory combined |
| 3400-xx-1299-01 | factory combined |

The following can be made from 8400-xx-1006 or 3400-xx-1006 cylinder kit using OEM adapters:

Master System 29—Use with adapter from Master

| | |
|-----------------|------------------|
| 8400-xx-1206-01 | factory combined |
| 3400-xx-1206-01 | factory combined |

Master Pro Series—Use adapter #0298-0626 from Master.

| | |
|-----------------|------------------|
| 8400-xx-1206-01 | factory combined |
| 3400-xx-1206-01 | factory combined |

American 3600 & 3700—Use with modified adapter. See below.

| | |
|-----------------|------------------|
| 8400-xx-1206-01 | factory combined |
| 3400-xx-1206-01 | factory combined |

Made with the “99”

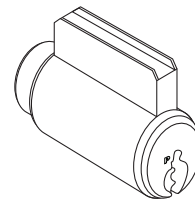

Made with the “06”

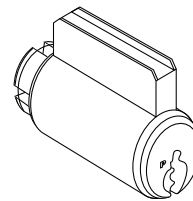

American padlocks

Use 8400-xx-1006 or 3400-xx-1006 cylinder.

Shorten Medeco adapter .050"



Lori adapter may also be modified.

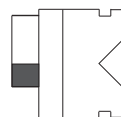

1. “L” adapter

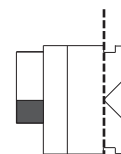

2. shorten adapter*



3. notch for key tip and retainer ring

*Dealers have reported that shortening isn't always necessary.

Padlocks—Small Format Interchangeable Core

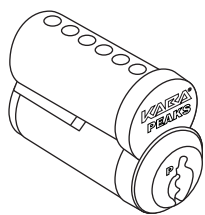

8800 or 8900 series and 3800 or 6800 cores fit any padlock prepared for 6-pin ICore, including:

Abus 381C/45
American 3200 & 3500 series
Arrow
Best (Except .150" Spacing)

Falcon
Master Proseries 6400 & 6500
Wilson Bohannon

6-pin 140

For 6-pin core in 7-pin housing, use spacer 3800-00-3007



Padlocks—Large Format Interchangeable Core

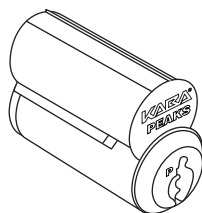

Corbin Russwin
PL5070 padlocks:
use 8144 or 6140

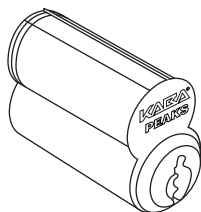

Medeco 50 series
brass padlocks:
use 6340

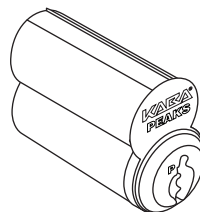

Sargent 758 series
padlocks: use
8544 or 6540

6-pin 140

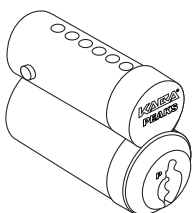

Schlage PL4XXX
series padlocks:
use 8444 or 6440

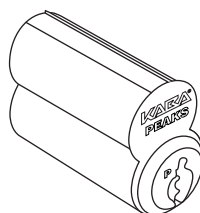

Yale 424 and 434
series padlocks:
use 8244 or 6240

Cabinet Locks and Specialty Applications

- 8800/8900 or 3800/6800 small format interchangeable cores can be installed in most cabinet locks, mailbox locks and switch locks prepped for small format interchangeable core.
- Olympus cabinet lock with Corbin Russwin large format interchangeable cores prep: use 8144 or 6140 series large format interchangeable cores
- Olympus 720, 721, 722 & 728 series: use 8800/8900 or 3800/6800 series small format interchangeable cores
- Olympus 700 & 800 series cabinet locks: use 8400-xx-1099 or 3400-xx-1099 with Olympus 78-Kaba-Conv Kit
- Schlage CL1000 and CL2000 series: use 8400-xx-1099 or 3400-xx-1099 with Schlage tailpiece and driver

Small Format Interchangeable Cores (Capped)—8800/3800 Series

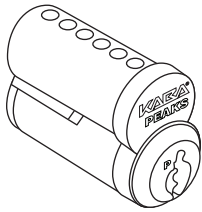

- brass plug
- brass shell and control sleeve
- capped pin chambers
- individual chambers may be emptied with ejector tool
- 140 capping block / press required
- face of plug is key stop for longer core life
- retrofits Arrow, Best, Falcon, KSP, or Lockwood small format interchangeable cores prep

**6-pin 140 &
6 or 7-pin 150**

| uncombined: | combined: | |
|--------------|--------------|------------|
| 8840-xx-1006 | 8840-xx-1206 | 140, 6-pin |
| 8850-xx-1006 | 8850-xx-1206 | 150, 6-pin |
| 8850-xx-1007 | 8850-xx-1207 | 150, 7-pin |
| 3840-xx-1006 | 3840-xx-1206 | 140, 6-pin |
| 3850-xx-1006 | 3850-xx-1206 | 150, 6-pin |
| 3850-xx-1007 | 3850-xx-1207 | 150, 7-pin |

Uses:
3800-00-4221 individual caps
3425-34-4002 C-ring plug retainer
For 6-pin core in 7-pin housing,
use spacer 3800-00-3007



Small Format Interchangeable Cores (Spring Loaded)—8900/6800 Series

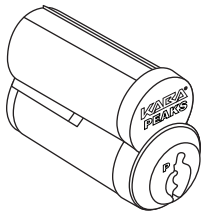

- brass plug
- alloy shell and control sleeve with patented plating and coating
- spring cover retains pins and springs
- 6840-00-3540 staking fixture and 6440-00-4001 staking tool required
- face of plug is key stop for longer core life
- retrofits Arrow, Best, Falcon, KSP or Lockwood small format interchangeable cores prep

**6-pin 140 &
6 or 7-pin 150**

| uncombined: | combined: | |
|--------------|--------------|------------|
| 8940-xx-1006 | 8940-xx-1206 | 140, 6-pin |
| 8950-xx-1006 | 8950-xx-1206 | 150, 6-pin |
| 8950-xx-1007 | 8950-xx-1207 | 150, 7-pin |
| 6840-xx-1006 | 6840-xx-1206 | 140, 6-pin |
| 6850-xx-1006 | 6850-xx-1206 | 150, 6-pin |
| 6850-xx-1007 | 6850-xx-1207 | 150, 7-pin |

Uses:
6800-00-2006 6-pin, or 6800-00-2007
7-pin spring covers
3425-34-4002 C-ring plug retainer
For 6-pin core in 7-pin housing,
use spacer 3800-00-3007



Large Format Interchangeable Cores for Corbin Russwin—8144/6140 Series

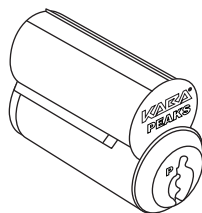

- brass plug
- alloy shell and control sleeve with patented plating and coating
- spring cover retains pins and springs
- 6840-00-3540 staking fixture and 6440-00-4001 staking tool required
- face of plug is key stop for longer core life
- no restricted control combinations

6-pin 140

- This product uses a large diameter plug.
J series bottom pins required for A2 system pinning.
K series bottom pins required for A4 system pinning.

| uncombined: | combined: | |
|--------------|--------------|------------|
| 8144-xx-1006 | 8144-xx-1206 | 140, 6-pin |
| 6140-xx-1006 | 6140-xx-1206 | 140, 6-pin |

Uses:
3425-00-2006 mortise/rim spring cover
6140-00-4002 C-ring plug retainer

Large Format Interchangeable Cores for Yale—8244/6240 Series

6-pin 140

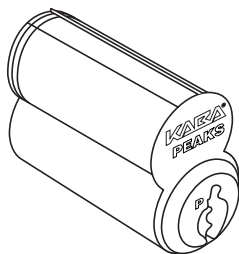

- brass plug
- alloy shell and control sleeve with patented plating and coating
- spring cover retains pins and springs
- 6840-00-3540 staking fixture and 6440-00-4001 staking tool required
- does not require a special extended tip control blank
- face of plug is key stop for longer core life
- retrofits Medeco 31

| uncombined: | combined: | |
|--------------|--------------|--------------------------|
| 8244-xx-1006 | 8244-xx-1206 | for Yale 1210 140, 6-pin |
| 6240-xx-1006 | 6240-xx-1206 | for Yale 1210 140, 6-pin |
| 6240-xx-1007 | 6240-xx-1207 | for Yale 1220 140, 7-pin |

Uses:
 3425-00-2006 mortise/rim spring cover
 6240-00-4002 C-ring plug retainer

NOTE: Yale cores are not interchangeable across Yale's product line. It must be determined if you are replacing a Yale 1210, 6-pin core, or a Yale 1220, 7-pin core.

8244-xx-1006
 6240-xx-1006
 retrofits Yale 1210 in 6-pin housings ONLY

6240-xx-1007
 retrofits Yale 1210 in 7-pin housings ONLY

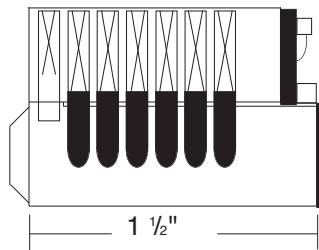
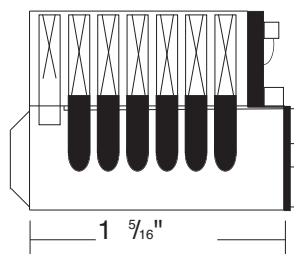

Large Format Interchangeable Cores for Medeco 32—6340 Series

6-pin 140

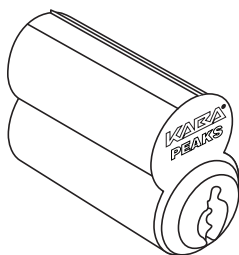

- brass plug
- alloy shell and control sleeve with patented plating and coating
- spring cover retains pins and springs
- 6840-00-3540 staking fixture and 6440-00-4001 staking tool required
- no forbidden or mandatory control combinations
- face of plug is key stop for longer core life

| uncombined: | combined: | |
|--------------|--------------|------------|
| 6340-xx-1006 | 6340-xx-1206 | 140, 6-pin |

Uses:
 6340-00-4012 timing pin
 6340-00-4002 C-ring plug retainer
 6800-00-2007 7-pin small format interchangeable core spring cover

Large Format Removable Cores for Schlage—8444/6440 Series

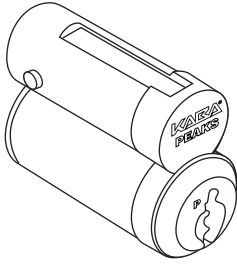

- brass plug
- alloy shell and control sleeve with patented plating and coating
- spring cover retains pins and springs
- 6440-00-3540 staking fixture and 6440-00-4001 staking tool required
- pins like original small format interchangeable cores; A2 system stacks to 26
- face of plug is key stop for longer core life
- 6440-00-2000 spring cover
- 6140-00-4002 C-ring plug retainer

6-pin 140

| uncombined: | combined: | | Uses: |
|--------------|--------------|------------|-----------------------------------|
| 8444-xx-1006 | 8444-xx-1206 | 140, 6 pin | 6440-00-2000 spring cover |
| 6440-xx-1006 | 6440-xx-1206 | 140, 6 pin | 6140-00-4002 C-ring plug retainer |

NOTE: Dedicated pin kit #6440-00-5002 required: Available for A2 system pinning only.

Large Format Removable Cores for Sargent—8544/6540 Series

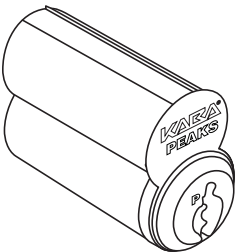

- brass plug
- alloy shell and control sleeve with patented plating and coating
- spring cover retains pins and springs
- 6840-00-3540 staking fixture and 6440-00-4001 staking tool required
- no forbidden or mandatory control combinations
- face of plug is key stop for longer core life
- This product uses a large diameter plug.
J series bottom pins required for A2 system pinning.
K series bottom pins required for A4 system pinning.

6-pin 140

| uncombined: | combined: | | Uses: |
|--------------|--------------|------------|--|
| 8544-xx-1006 | 8544-xx-1206 | 140, 6 pin | 6340-00-4012 timing pin |
| 6540-xx-1006 | 6540-xx-1206 | 140, 6 pin | 6800-00-2007 7-pin small format interchangeable cores spring cover |
| | | | 6140-00-4002 C-ring plug retainer |

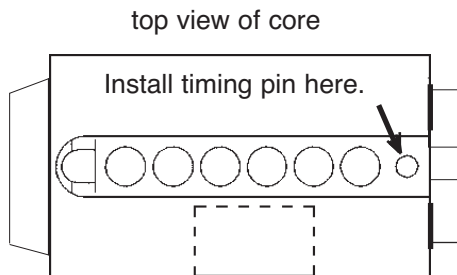

Timing pin engages slot in sleeve to create positive key pull stop for control key.

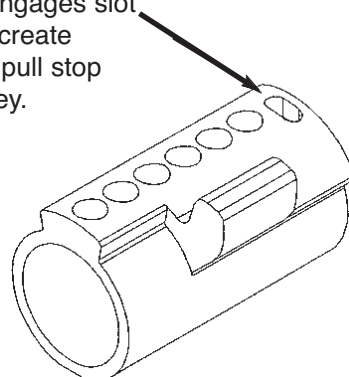

Product Specification and Testing Data

For specification purposes, 6-pin Peaks products have seven active pin stacks and 7-pin Peaks products have eight active pin stacks. Texts of product specifications are available upon request.

Mechanical Testing

Testing of 8900/6800 series cores has proven them to be superior to the 8800/3800 series cores. The modern alloys used in the shells and sleeves of the 8900/6800 series have remarkable bearing properties. In addition, Kaba employs a patented two step process of plating and cladding on all 8900/6800 and 8400/3400 sleeves and shells that makes the surfaces of these components harder than conventional brass surfaces. Plugs for both 8900/6800 and 8800/3800 series are made of brass because of its machinability.

Peaks cores and cylinders exceed 500,000 cycles with no measurable wear on shells and sleeves. Keys, keyways and bottom pins show normal wear. When 8900/6800 series cores are cut open, tool marks remain visible in the pin chambers.

Pull tests have been successfully completed on Peaks cores in Arrow, Best, KSP, Corbin Russwin and Yale housings. The 8900/6800 cores actually require more force than 8800/3800 series cores. This is due to the behavioral characteristics of the metals. All brass tends to shear, while the alloys employed in the 8900/6800 tend to distend but hold.

Environmental testing

The standard ASTM B117 salt spray (corrosion) test for trim is 200 hours. After over 300 hours, both control and operating keys work in Peaks cores, even before lubrication. After lubrication, the cores feel like new. Chrome finish cores do not discolor. Brass finish cores may darken with exposure to the elements.

Product in development, warranty and updates

The catalog indicates current product availability. Product is always under development. Contact Kaba Access Control about retrofits not currently shown. The last page of the catalog is a one page summary of pinning components. Warranty and return policies are in the catalog. ***Non-original pins will not work properly in Kaba products and their use voids product warranty.***



PEAKS[®] Preferred/Classic

Technical Manual

Section 3: Key Cutting and Pinning



Cylinder Stamping, Marking, Lubrication & Tailpiece Installation

Stamping and Marking

Kaba Access Control recommends marking cylinders with an indelible marker. If stamping or engraving of cast cylinders is unavoidable the stamped or engraved area must be coated with a clear acrylic enamel (Krylon, fingernail polish, etc.). Application by brush is preferable, but spray is acceptable as long as care is taken to reduce overspray. Key-in-knob cylinders should never be stamped. Cores should be stamped on the top half of the shell. Mortise and rim cylinders should be stamped on the back of the shell.

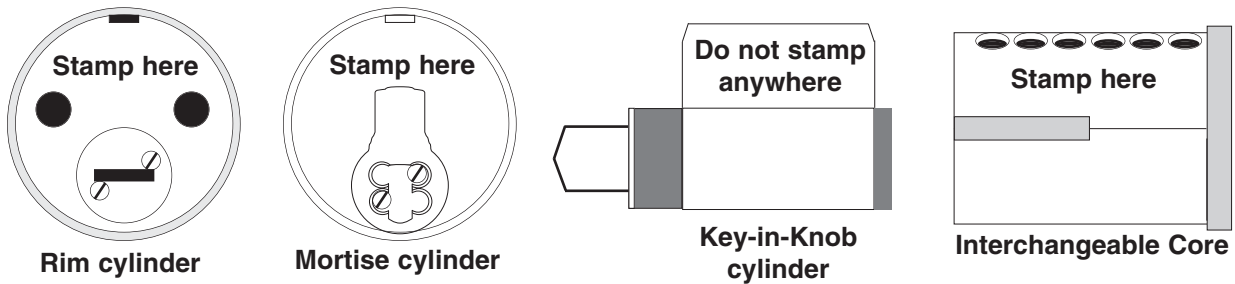

Lubrication

Kaba recommends the use of Poxylube® (a dry spray) for all Peaks Preferred cylinders.

Tailpiece Installation

Tailpiece inserted correctly, allowing tip of key full insertion.

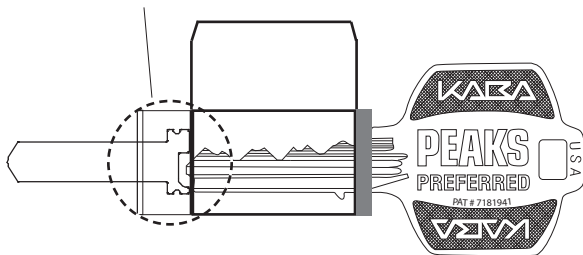

Tailpiece inserted upside down, preventing full key insertion.

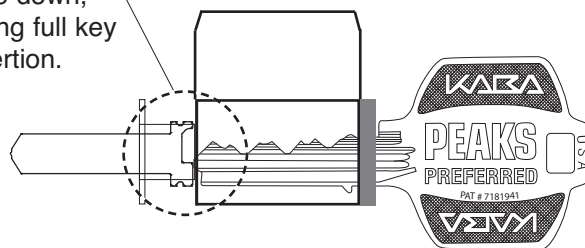

When inserting tailpiece horizontally it can be flipped either way for proper operation.

Key Bitting Specifications

Stops

Peaks keys have two stops, a *bow stop* and a *tip stop*. The bow stop gauges keys in all current products. The tip stop gauges only in non-domed face small format interchangeable cores made prior to March, 1996. Either stop may be used when code cutting depending on the machine employed.

Most Peaks key sections are paracentric and not designed to be clipped on a key bitting punch. Paracentric keyways are preferred for their enhanced pick resistance. They also produce many more keyway variations than flat bladed keys.

Factory bittings are tip to bow

Factory bitting lists are written tip to bow. When using card-type key machines such as the Ilco Universal II or HPC 1200 CM, it is suggested that keys be cut bow to tip to lessen the effects of the backlash of the rack-and-pinion mechanism. Care must be taken in reversing bittings written as tip to bow.

Tolerances and milling cutters

Peaks tolerances are tighter than most other brands. Both depth and spacing must be held within +/- 0.002" for proper operation. Key machines must be kept in precise adjustment. The required cutter angle is 90 degrees for proper key insertion. A cut root flat of .046" is required. The 90MC or equivalent cutter is recommended.

Position next to the Peak

In the position next to the Peak, cuts deeper than a #6 in the A2 system or a #3 in the A4 system require the use of an asymmetrical cutter, such as the #1011.

The 90MC cutter can not be used as it removes the upper Peak when making these deep cuts next to the Peak.

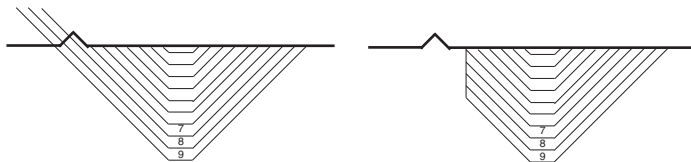

MACS

140 A2 MACS is 8.

140 A4 MACS is 4.

150 A2 MACS is 9.

150 A4 MACS is 5.

Depth and spacing data

| Depths | | | .140 Spacing | | .150 Spacing | | | |
|--------|-------|-------|--------------|----------|--------------|----------|-------|--------|
| | A2 | A4 | from tip | from bow | from tip | from bow | | |
| 0 | .318" | .318" | 1 | .136" | 1.030" | 0 | .086" | 1.080" |
| 1 | .305" | .297" | 2 | .276" | .890" | 2 | .236" | .930" |
| 2 | .293" | .276" | 3 | .416" | .750" | 3 | .386" | .780" |
| 3 | .280" | .255" | 4 | .556" | .610" | 4 | .536" | .630" |
| 4 | .268" | .234" | 5 | .696" | .470" | 5 | .686" | .480" |
| 5 | .255" | .213" | 6 | .836" | .330" | 6 | .836" | .330" |
| 6 | .243" | | | | | | | |
| 7 | .230" | | | | | | | |
| 8 | .218" | | | | | | | |
| 9 | .205" | | | | | | | |

Cutting Keys by Code

Peaks tolerances are tighter than most other brands. Both depth and spacing must be held within +/- 0.002" for proper key operation. Key machines should be periodically gauged to maintain tolerances.

Framon #2

Contact Framon at 517-354-5623 regarding a Peaks tip stop. Use the bitting specifications in this manual.

Framon KX-1

The KX-1 cuts 140 - 6 pin keys

Framon FRA-2001

This machine is computer operated and a Peaks vise jaw is required.

HPC Codemax

The following are the correct DSD numbers for Peaks.

| | <u>140, 6-pin</u> | <u>150, 6-pin</u> | <u>150, 7-pin</u> |
|----|----------------------------|----------------------------|-------------------------------------|
| A2 | DSD608, A jaw/red tip stop | DSD606, A jaw/red tip stop | DSD607, modified B jaw/bow stop |
| A4 | DSD612, A jaw/red tip stop | DSD615, A jaw/red tip stop | DSD616, modified B jaw/bow tip stop |

Codemax cuts all keys bow to tip. Peaks systems are written tip to bow. Reverse the bittings on factory lists.

HPC/LaGard 1200CM

HPC manufactures the following A2 system card for Peaks:

| | |
|---|---|
| 140, 6-pin: HPC card number CPKS1 red tip stop, standard A jaw | 150, 6 and 7 -pin: HPC card number CPKS2 horseshoe tip stop, modified B vise jaw |
|---|---|

The modified B vise jaw required to cut Peaks keys on the 1200CM is available from Kaba.

Spacing on HPC cards is bow to tip. When using a factory bitting list, reverse the bittings. In December 1996, HPC began to provide a calibration kit for the 1200, part no. CMB-CK. A spacing calibration key is available from Kaba to check the accuracy of the space adjustment. Because of rack-and-pinion backlash, better keys may be produced by reversing the bittings and cutting bow to tip.

ITL9000

Machines purchased after September 1992 already have Peaks data installed and the key rest milled to accommodate the bottom peak.

ILCO Universal II

Use 0.140" spacing disc. The 0.0125" depth disc is used for A2 system. The 0.021" depth disc is used for A4 system. Use tip stop on the 27B key rest. For 6-pin keys, chamfer the corner of the key rest for bottom peak clearance.

Duplication

Automatic duplicating machines like the ILCO #017 currently require field modification of the vise jaw for the bottom peak. As of August 1992, Rytan machines are manufactured with a divot in the jaw.

Components for Pinning

Peaks products may be pinned to the A2 or A4 system. The patent pin stack is built into the face of all small format interchangeable cores. In large format interchangeable cores and conventional cylinders, the patent pins are installed when combining. Certain products have a large diameter plug and require longer bottom pins. All products use the same top pins.

Peaks Preferred Patent pins

 3425-00-3002
patent top pin
(for conventionals & KIK)

 3800-00-3005
patent top pin
(all cores other than conventional & KIK)

 8800-00-3004
patent bottom pin for all
products except those with
large diameter plugs

 8144-00-3004
patent bottom pin for the Universal 8400-xx-1099, the
8400-xx-1095 key-In-knob, the 8144 Corbin Russwin,
the 8544 Sargent and the 8444 Schlage large format
interchangeable cores.

Spring





3800-00-4010
stainless steel for all Peaks products
except 8444
6440-00-4010

Peaks Classic Patent pins

 3425-00-3002
patent top pin
(for conventionals & KIK)

 3800-00-3005
patent top pin
(all cores other than conventionals & KIK)

 3800-00-3004
patent bottom pin for all
products except those with
large diameter plugs

 6140-00-3004
patent bottom pin for the Universal 3400-xx-1099, the
3400-xx-1095 key-In-knob, the 6140 Corbin Russwin,
the 6540 Sargent and the 6440 Schlage large format
interchangeable core

Spring



3800-00-4010
stainless steel for all Peaks products
except 6440
6440-00-4010

Tumbler pins

Peaks pins are crowned for smooth operation and long cylinder life. Bottom pins are nickel silver. Spool pins are used to increase pick and impression resistance. Bottom pins are .003" shorter than after market replacement pins. **Non-original pins will not work properly in Kaba products and their use voids product warranty.**

A2 system: Use A series bottom pins for everything except the 8400-xx-1095 and 3400-xx-1095 key-in-knob, the Universal 8400-xx-1099 and 3400-xx-1099 key-in-knob cylinder, the 8144/6140 Corbin Russwin, and 8544/6540 Sargent large format interchangeable core with large diameter plugs. J series bottom pins are required for products with large diameter plugs. Use B series master/top pins for all products.

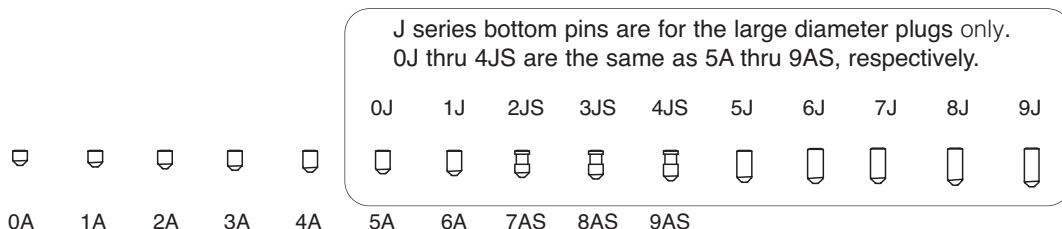

A4 system: Use E series bottom pins for everything except the 8400-xx-1095 and 3400-xx-1095 key-in-knob, the Universal 8400-xx-1099 and 3400-xx-1099 key-in-knob cylinder and the 8144/6140 Corbin Russwin large format interchangeable core with large diameter plugs. K series bottom pins are required for products with large diameter plugs. Use F series master/top pins for all products.

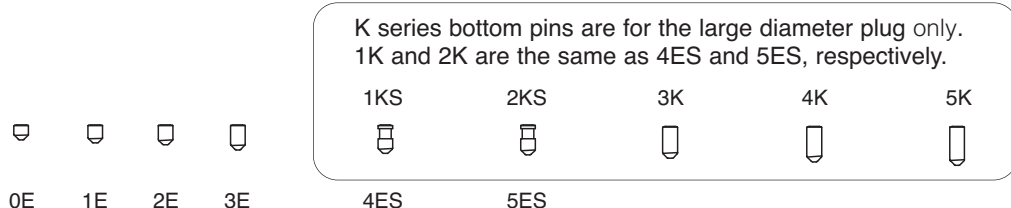

Components for Pinning (continued)

Peaks Preferred Spring covers

Spring covers are curved. Install them by flattening with the 3400-00-4001 staking tool.



6440-00-2000
key-in-knob

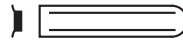

6800-00-2006
6-pin 6800 small format interchangeable cores



3425-00-2006
mortise, rim, Corbin Russwin and Yale
large format interchangeable cores

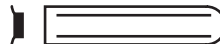

6800-00-2007
7-pin 6800 small format interchangeable cores,
5340 Medeco large format interchangeable cores

Peaks Classic Spring covers

Spring covers are curved. Install them by flattening with the 3400-00-4001 staking tool.

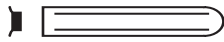

6440-00-2000
key-in-knob

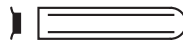

6800-00-2006
6-pin 6800 small format interchangeable cores

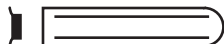

3425-00-2006
mortise, rim, Corbin Russwin
and Yale large format inter-
changeable cores

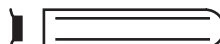

6800-00-2007
7-pin 6800 small format interchangeable cores,
5340 Medeco large format interchangeable cores

Universal pin kits

Peaks universal pin kits (3400-00-5012 for A2 and 3400-00-5004 for A4) contain all of the components required to pin any uncombined cylinder or core, including the 6340-00-4012 timing pin.

Non-original pins will not work properly in Kaba products and their use voids product warranty.

Pin Lengths and Stack Heights

Pin lengths and material

Kaba bottom pins are .003" shorter than after market replacement pins.

Non-original pins will not work properly and void the product warranty.

"S" indicates spool type pins. Bottom pins are nickel silver.

Top pins are brass.

| bottom pin part number | length | A2 | A2 | A4 | A4 |
|------------------------|--------|-----|-----|-----|-----|
| 3800-00-3200 | .107 | 0A | | 0E | |
| -3201 | .1195 | 1A | | | |
| -3202 | .132 | 2A | | | |
| -3203 | .1445 | 3A | | | |
| -3204 | .157 | 4A | | | |
| -3205 | .1695 | 5A | 0J | 3E | 0K |
| -3206 | .182 | 6A | 1J | | |
| -3207 | .1945 | 7AS | 2JS | | |
| -3208 | .207 | 8AS | 3JS | | |
| -3209 | .2195 | 9AS | 4JS | | |
| 3800-00-3401 | .128 | | | 1E | |
| -3402 | .149 | | | 2E | |
| -3404 | .191 | | | 4ES | 1KS |
| -3405 | .212 | | | 5ES | 2KS |
| 6140-00-3205 | .2325 | | 5J | | 3K |
| -3206 | .2445 | | 6J | | |
| 3207 | .257 | | 7J | | |
| -3208 | .2695 | | 8J | | |
| -3209 | .282 | | 9J | | |
| 6140-00-3404 | .254 | | | | 4K |
| -3405 | .275 | | | | 5K |

| top pin part number | length | A2 | A4 |
|---------------------|--------|------|-----|
| 3800-00-4202 | .025 | 2B | |
| -4203 | .0375 | 3B | |
| -4204 | .050 | 4B | |
| -4205 | .0625 | 5B | |
| -4206 | .075 | 6BS | |
| -4207 | .0875 | 7B | |
| -4208 | .100 | 8BS | |
| -4209 | .1125 | 9B | |
| -4210 | .125 | 10BS | 6FS |
| -4211 | .1375 | 11B | |
| -4212 | .150 | 12B | |
| -4213 | .1625 | 13B | |
| -4214 | .175 | 14B | |
| -4215 | .1875 | 15B | |
| -4216 | .200 | 16B | |
| -4217 | .2125 | 17B | |
| -4218 | .225 | 18B | |
| -4219 | .2375 | 19B | |
| 3800-00-4401 | .021 | | 1F |
| -4402 | .042 | | 2F |
| -4403 | .063 | | 3F |
| -4404 | .084 | | 4FS |
| -4405 | .105 | | 5FS |
| -4407 | .147 | | 7F |
| -4408 | .168 | | 8F |
| -4409 | .189 | | 9F |
| -4410 | .210 | | 10F |
| -4411 | .231 | | 11F |















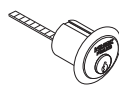







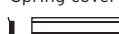



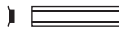











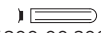
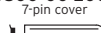

















Peaks Preferred Pin series and uniform stack heights for A2 and A4 systems

| product system | 8400 K-I-K <u>except</u> 8400-xx-1099 8400-xx-1095 | 8400-xx-1099 8400-xx-1095 with large diameter plug | 8401/8402 conventional mortise and rim | 8800 and 8900 SFIC | 8144 Corbin Russwin R/C with large diameter plug | 8244 Yale | 8444 Schlage R/C | 8544 Sargent R/C |
|---------------------------------|---|---|---|-----------------------------|---|--------------|------------------------|------------------------|
| <u>A2 system</u> stack total | 26 | 26 | 31 | 23 | 26 | 26 | 26 | 26 |
| top pins | B series | B series | B series | B series | B series | B series | W series | B series |
| bottom pins | A series | J series | A series | A series | J series | A series | X series | J series |
| <u>A4 system</u> stack total | 15 | 15 | 18 | 14 | 15 | 15 | NA | 15 |
| top pins | F series | F series | F series | F series | F series | F series | | F series |
| bottom pins | E series | K series | E series | E series | K series | E series | | K series |















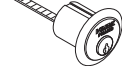

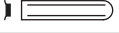





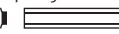



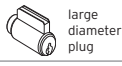
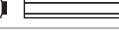











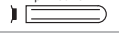





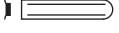











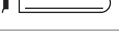



Peaks Classic Pin series and uniform stack heights for A2 and A4 systems

| product system | 3400 key-in-knob <u>except</u> 3400-xx-1099 3400-xx-1095 | 3400-xx-1099 3400-xx-1095 with large diameter plug | 3401/3402 conventional mortise and rim | 3800 and 6800 I/C | 6140 Corbin Russwin R/C with large diameter plug | 6240 Yale and 6340 Medeco R/C |
|---------------------------------|---|---|---|----------------------------|---|--|
| <u>A2 system</u> stack total | 26 | 26 | 31 | 23 | 26 | 26 |
| top pins | B series | B series | B series | B series | B series | B series |
| bottom pins | A series | J series | A series | A series | J series | A series |
| <u>A4 system</u> stack total | 15 | 15 | 18 | 14 | 15 | 15 |
| top pins | F series | F series | F series | F series | F series | F series |
| bottom pins | E series | K series | E series | E series | K series | E series |

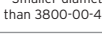
Peaks Preferred Component Summary Table

| Product | Retainer | Spring Retainer | Patent Bottom | Patent Top | System | Pins | Stack Height | Springs |
|---|---|--|---|---|--------|-------|--------------|---|
| 8401 Mortise  | Specify cam 4701-98-4118 cam screws 3418-00-2000 cam cover | 3425-00-2006 Mortise/Rim/RC Spring cover  | 8800-00-3004  | 3425-00-3002  | A2 | A & B | 31 | 3800-00-4010 Stainless |
| | | | | | A4 | E & F | 18 |  |
| 8402 Rim  | 3410-00-2001 retainer  | 3425-00-2006 Mortise/Rim/RC Spring cover  | 8800-00-3004  | 3425-00-3002  | A2 | A & B | 31 | 3800-00-4010 Stainless |
| | | | | | A4 | E & F | 18 |  |
| 8400 key-in-knob except 1095 and 1099  | 3425-36-4002 C-ring  | 6440-00-2000 Key-in-knob Spring cover  | 8800-00-3004  | 3425-00-3002  | A2 | A & B | 26 | 3800-00-4010 Stainless |
| | | | | | A4 | E & F | 15 |  |
| 8400-XX-1095 and 8400-XX-1099  | Screw cap plug retainer accepts other mfg's tailpieces | 6440-00-2000 Key-in-knob Spring cover  | 8144-00-3004  | 3425-00-3002  | A2 | J & B | 26 | 3800-00-4010 Stainless |
| | | | | | A4 | K & F | 15 |  |
| 8800 ICore  | 3425-34-4002 C-ring  | 3800-00-4221 Caps  | 8800-00-3004 Installed at factory  | 3800-00-3005 Installed at factory  | A2 | A & B | 23 | 3800-00-4010 Stainless |
| | | | | | A4 | E & F | 14 |  |
| 8900 ICore  | 3425-34-4002 C-ring  | 6800-00-2006 6-pin cover  6800-00-2007 7-pin cover  | 8800-00-3004 Installed at factory  | 3800-00-3005 Installed at factory  | A2 | A & B | 23 | 3800-00-4010 Stainless |
| | | | | | A4 | E & F | 14 |  |
| 8144 Corbin Russwin RCore  | 6140-00-4002 C-ring  | 3425-00-2006 Mortise / Rim / RC Spring cover  | 8144-00-3004  | 3800-00-3005  | A2 | J & B | 26 | 3800-00-4010 Stainless |
| | | | | | A4 | K & F | 15 |  |
| 8244 Yale RCore  | 6240-00-4002 C-ring  | 3425-00-2006 Mortise/Rim/RC Spring cover  | 8800-00-3004  | 3800-00-3005  | A2 | A & B | 26 | 3800-00-4010 Stainless |
| | | | | | A4 | E & F | 15 |  |
| 8444 Schlage RCore  | 6140-00-4002 C-ring  | 6440-00-2000 Spring cover  | 8144-00-3004  | 3800-00-3005  | A2 | X & W | 26 | 6440-00-4010 Stainless |
| | | | | | A4 | N/A | 15 |  |
| 8544 Sargent RCore  | 6140-00-4002 C-ring  | 6800-00-2007 7-pin cover  | 8144-00-3004  | 3800-00-3005  | A2 | J & B | 26 | 3800-00-4010 Stainless |
| | | | | | A4 | K & F | 15 |  |

Peaks Classic Component Summary Table

| Product | Retainer | Spring Retainer | Patent Bottom | Patent Top | System | Pins | Stack Height | Springs |
|---|---|---|---|---|--------|-------|--------------|--|
|  3401 Mortise | Specify cam 4701-98-4118 cam screws 3418-00-2000 cam cover | 3425-00-2006 Mortise/Rim/RC Spring cover  | 3800-00-3004  | 3425-00-3002  | A2 | A & B | 31 | 3800-00-4010 Stainless |
| | | | | | A4 | E & F | 18 |  |
|  3402 Rim | 3410-00-2001 retainer  | 3425-00-2006 Mortise/Rim/RC Spring cover  | 3800-00-3004  | 3425-00-3002  | A2 | A & B | 31 | 3800-00-4010 Stainless |
| | | | | | A4 | E & F | 18 |  |
|  3400 key-in-knob except 1095 and 1099 small diameter plug | 3425-36-4002 C-ring  | 6440-00-2000 Key-in-knob Spring cover  | 3800-00-3004  | 3425-00-3002  | A2 | A & B | 26 | 3800-00-4010 Stainless |
| | | | | | A4 | E & F | 15 |  |
|  3400-XX-1095 and 3400-XX-1099 large diameter plug | Screw cap plug retainer accepts other mfg's tailpieces | 6440-00-2000 Key-in-knob Spring cover  | 6140-00-3004  | 3425-00-3002  | A2 | J & B | 26 | 3800-00-4010 Stainless |
| | | | | | A4 | K & F | 15 |  |
|  3800 ICore | 3425-36-4002 C-ring  | 3800-00-4221 Caps  | 3800-00-3004 Installed at factory  | 3800-00-3005 Installed at factory  | A2 | A & B | 23 | 3800-00-4010 Stainless |
| | | | | | A4 | E & F | 14 |  |
|  6800 ICore | 3425-36-4002 C-ring  | 6800-00-2006 6-pin cover  6800-00-2007 7-pin cover  | 3800-00-3004 Installed at factory  | 3800-00-3005 Installed at factory  | A2 | A & B | 23 | 3800-00-4010 Stainless |
| | | | | | A4 | E & F | 14 |  |
|  6140 Corbin Russwin RCore | 6140-00-4002 C-ring  | 3425-00-2006 Mortise / Rim / RC Spring cover  | 6140-00-3004  | 3800-00-3005  | A2 | J & B | 26 | 3800-00-4010 Stainless |
| | | | | | A4 | K & F | 15 |  |
|  6240 Yale RCore | 6240-00-4002 C-ring  | 3425-00-2006 Mortise/Rim/RC Spring cover  | 3800-00-3004  | 3800-00-3005  | A2 | A & B | 26 | 3800-00-4010 Stainless |
| | | | | | A4 | E & F | 15 |  |
|  6340 Medeco RCore | 6340-00-4002 C-ring  | 6800-00-2007 7-pin cover  | 3800-00-3004  | 3800-00-3005  | A2 | A & B | 26 | 3800-00-4010 Stainless |
| | | | | | A4 | E & F | 15 |  |
|  6440 Schlage RCore | 6140-00-4002 C-ring  | 6440-00-2000 Spring cover  | 6140-00-3004  | 3800-00-3005  | A2 | X & W | 26 | 6440-00-4010 Stainless |
| | | | | | A4 | N/A | 15 |  Smaller diameter than 3800-00-4010 |
|  6540 Sargent RCore | 6140-00-4002 C-ring  | 6800-00-2007 7-pin cover  | 6140-00-3004  | 3800-00-3005  | A2 | J & B | 26 | 3800-00-4010 Stainless |
| | | | | | A4 | K & F | 15 |  |

Pinning Conventional Cylinders

Peaks conventional cylinders are designed to be top loaded. Install the Peaks patent bottom and top pins in the patent chamber immediately next to the plug face. Peaks Classic patent bottom pins are installed small end down, whereas Peaks Preferred patent bottom pins are installed small end up. Install the Peaks patent top pins small end down for both Peaks Classic and Preferred. **In the A2 system a number 7 top pin should be seated above the patent top pin. In A4 use a number 4 top pin above the patent top pin.**

Pin stacks

Consult the charts on pages 3 - 17 and 3 - 20 for the correct pins.

The Universal 8400-xx-1099 and the 8400-xx-1095 key-in-knob cylinder have large diameter plugs and require longer bottom pins and the 8144-00-3004 patent bottom pin.

The Universal 3400-xx-1099 and the 3400-xx-1095 key-in-knob cylinder have large diameter plugs and require longer bottom pins and the 6140-00-3004 patent bottom pin.

All conventional cylinders, Peaks Preferred/Classic use the same top pins. Observe the specified pin stack heights. After loading the pins install a 3800-00-4010 stainless steel tumbler spring in each chamber.

Staking

Place the cylinder in the correct cavity of the 3400-00-4000 staking fixture. Set the correct curved spring cover in place over the springs and hold it down with the staking tool.

Using a plastic or rawhide mallet, flatten the spring cover between the flanges. Do not strike the bible flanges on key-in-knob cylinders. Bending or breaking the flanges breaks the patented hard coat on the shells and can lead to corrosion.

The chrome key-in-knob cylinder shell requires a staking tool and new curved spring cover, 6440-00-2000. Older staking tools had a thick blade. The blade must be narrowed to 0.125" to fit between the bible flanges.

- Work on a firm bench surface.
- Strike tools gently with a plastic or rawhide mallet.
- Do not use excessive force.
- Use Kaba original equipment.

These are the tools required for conventional cylinders:

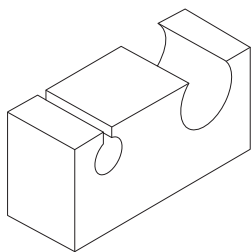

3400-00-4000 staking fixture for conventionals

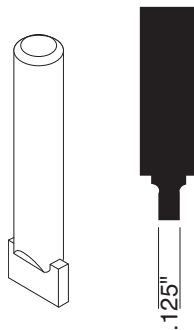

6440-00-4001 staking tool

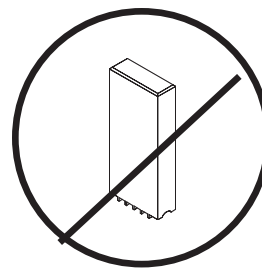

The 3400-00-4002 key-in-knob staking tool and flat spring covers are discontinued. Do not use this or similar tools on chrome key-in-knob cylinders.



Pinning Conventional Cylinders

Rekeying Conventional Cylinders

Pry off and discard the spring cover. Rekey and apply a new spring cover. Since all Peaks products are designed to be top loaded, use of a follower for rekeying is optional.

Mortise/rim cylinder screws have a Loctite® coating. If cams or plug retainers are removed, use new screws and tighten them firmly.

Pinning Interchangeable Cores

Pin to uniform pin stack height

Insert a key into the core and turn the plug 90 degrees. Extend the control lug into the locked position. Top load the core. Let the bottom pins stop against the plug as shown in figure 1.

All the stacks should have a uniform height. Dump any incorrect chamber and repin it. When the pin stack heights are uniform, turn the plug and let the pins drop into the plug.



1. Load pins with plug turned.

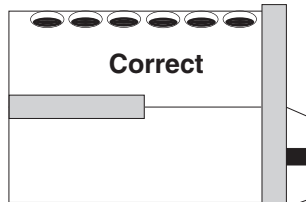

2. Uniform pin stack heights

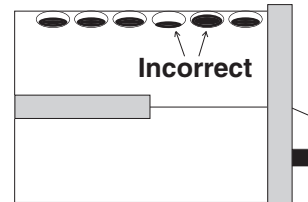

3. Errors in 4th and 5th chambers

8800/3800 series capped small format interchangeable cores

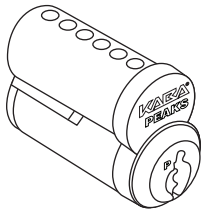

140 and 150 cores require different capping blocks. Place the core loaded with pins only, into the capping block. Insert a tumbler spring, 3800-00-4010, into each chamber by dropping them into the holes in the block.

One chamber at a time, place a cap on top of each spring and tap it in place with the capping tool and a plastic or rawhide mallet until the capping tool is flush against the block.

Do not use excessive force. Lubricate core with Poxylube® spray lubricant.

For high volume pinning, existing capping presses may be used for 150 cores.

For 140 cores, a capping press in .140" spacing is available from Kaba.



Rekeying

Place the ejector tool into the hole under the chamber(s) and drive out the pins, spring, and cap with a light tap.

Discard the elements and repin. Always use new springs and caps.

3800-00-3548
ejector tool

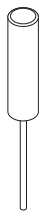

3800-00-3547
capping tool
is used with
both blocks



3840-00-3540
140 capping block
(6 holes)

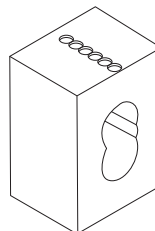

3850-00-3540
150 capping block
(7 holes)

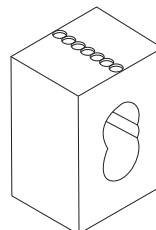

- Work on a firm bench surface.
- Strike tools gently with a plastic or rawhide mallet.
- Do not use a metal hammer.

Pinning Interchangeable Cores

8900/6800 series spring cover small format interchangeable cores

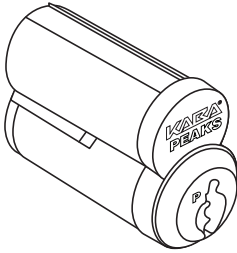

Place core loaded with pins and springs into the correct cavity of the 6840-00-3540 staking fixture. Place the correct spring cover (6-pin or 7-pin length) over the springs.

Set the staking tool on the cover. Gently tap the cover flat with a plastic or rawhide mallet. Do not use excessive force. Lubricate with Poxylube® spray lubricant.

Rekeying spring cover cores: Pry up and discard the spring cover. Dump the old pins and springs. Repin and stake on a new spring cover and lubricate with Poxylube® spray lubricant.

- Work on a firm bench surface.
- Strike tools gently with a plastic or rawhide mallet.
- Do not use excessive force.



6440-00-4001
staking tool for
use with all
spring covers

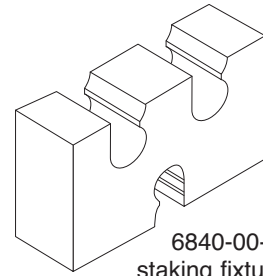

6840-00-3540
staking fixture for
Best, Corbin Russwin,
Medeco, and Yale
series cores

Staking technique

Capping blocks and fixtures are designed to support cores at their waist to prevent sleeves and shells from becoming out-of-round. Working without proper equipment and technique can cause deformation resulting in poor operation, and can void product warranty

- Use original pins and Kaba equipment.
- Do not use excessive force.
- Do not deform or score the shells.

8144/6140 large format interchangeable cores for Corbin Russwin

The 8144/6140 large format interchangeable cores for Corbin Russwin have an A2 system pin stack total of 26.

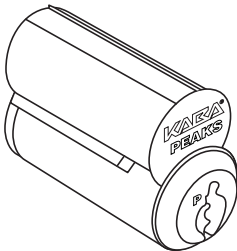

8144 cores use the large diameter plug and require the following components:

A2 system: J series bottom pins and B series top pins

A4 system: K series bottom pins and F series top pins

8144-00-3004 patent bottom pin

3800-00-3005 patent top pin

3800-00-4010 stainless steel tumbler springs

3425-00-2006 mortise/rim/large format interchangeable core spring covers

6140 cores use the large diameter plug and require the following components:

A2 system: J series bottom pins and B series top pins

A4 system: K series bottom pins and F series top pins

6140-00-3004 patent bottom pin

3800-00-3005 patent top pin

3800-00-4010 stainless steel tumbler springs

3425-00-2006 mortise/rim/large format interchangeable core spring covers

Top load the core in the usual manner. Stake in 6840-00-3540 staking fixture.

- Work on a firm bench surface.
- Strike tools gently with a plastic or rawhide mallet.
- Do not use excessive force.

Pinning Interchangeable Cores

8244/6240 large format interchangeable core for Yale

The 8244/6240 large format interchangeable core have an A2 system pin stack total of 26. Use 8244-xx-1006 or 6240-xx-1006 to retrofit Yale 1210.

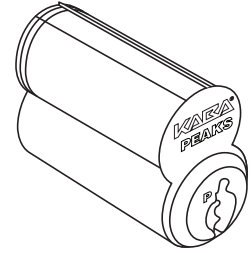

8244 cores use the following components:

A2 system: A series bottom pins and B series top pins
A4 system: E series bottom pins and F series top pins
8800-00-3004 patent bottom pin
3800-00-3005 patent top pin
3800-00-4010 stainless steel tumbler springs
3425-00-2006 mortise/rim spring covers

6240 cores use the following components:

A2 system: A series bottom pins and B series top pins
A4 system: E series bottom pins and F series top pins
3800-00-3004 patent bottom pin
3800-00-3005 patent top pin
3800-00-4010 stainless steel tumbler springs
3425-00-2006 mortise/rim spring covers

Top load the core in the usual manner. Stake in 6840-00-3540 staking fixture.

- Work on a firm bench surface.
- Strike tools gently with a plastic or rawhide mallet.
- Do not use excessive force.

6340 large format interchangeable core for Medeco 32 Series

The 6340 large format interchangeable core have an A2 system pin stack total of 26. The 6340 series requires a timing pin, number 6340-00-4012, which must be installed during pinning. Uncombined cores do not contain the timing pin. They can be found in the Peaks universal pin kits. Do not omit the timing pin. Omitting the timing pin will make it difficult to install the core.

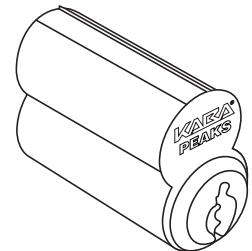

6340 cores use the following components:

A2 system: A series bottom pins and B series top pins
A4 system: E series bottom pins and F series top pins
6340-00-4012 timing pin
3800-00-3004 patent bottom pin
3800-00-3005 patent top pin
3800-00-4010 stainless steel tumbler springs
6800-00-2007 spring cover, 7-pin

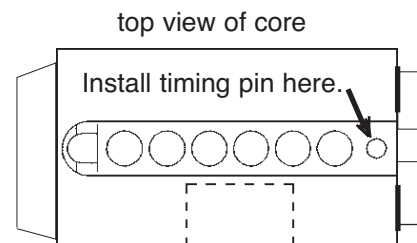

Top load core in the usual manner. Install 3800-00-3004 patent bottom pin and 3800-00-3005 patent top pin in the patent chamber. Use 3800-00-4010 stainless steel tumbler springs in all chambers.

The 6800-00-2007 7-pin small format interchangeable core spring cover is required to contain all the components. Apply spring cover using Peaks core staking fixture and staking tool.

- Work on a firm bench surface.
- Strike tools gently with a plastic or rawhide mallet.
- Do not use excessive force.

Pinning Interchangeable Cores

8444/6440 Schlage Removable Core

The 8444/6440 large format removable core has an A2 system pin stack total of 26.

8444 cores use the large diameter plug and require the following components:

A2 system: X series bottom pins and W series top pins

A4 system: A4 pinning not available

8144-00-3004 patent bottom pin

3800-00-3005 patent top pin

6440-00-2000 spring cover

6440-00-4010 stainless steel springs

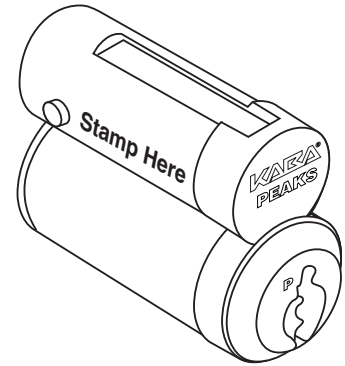

6440 cores use the large diameter plug and require the following components:

A2 system: X series bottom pins and W series top pins

A4 system: A4 pinning not available

6140-00-3004 patent bottom pin

3800-00-3005 patent top pin

6440-00-2000 spring cover

6440-00-4010 stainless steel springs

NOTE: Dedicated pin kit #6440-00-5002 required: Available for A2 system pinning only.

8544/6540 Sargent Removable Core

The 8544/6540 large format removable core has an A2 system pin stack total of 26.

The 8544/6540 has an A-4 system pin stack total of 15. The 8544/6540 series requires a timing pin, number 6340-00-4012. Do not omit the timing pin. Omitting the timing pin will make it difficult to install the core.

8544 cores use the following components:

A2 system: J series bottom pins and B series top pins

A4 system: K series bottom pins and F series top pins

6340-00-4012 timing pin

3800-00-3005 patent top pin

8144-00-3004 patent bottom pin

3800-00-4010 stainless steel springs

6800-00-2007 spring cover

6540 cores use the following components:

A2 system: J series bottom pins and B series top pins

A4 system: K series bottom pins and F series top pins

6340-00-4012 timing pin

3800-00-3005 patent top pin

6140-00-3004 patent bottom pin

3800-00-4010 stainless steel springs

6800-00-2007 spring cover

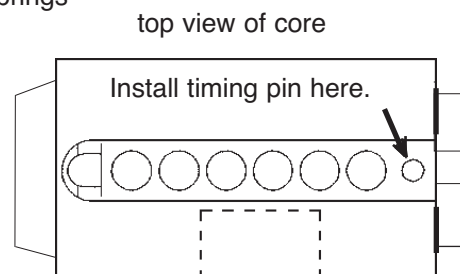
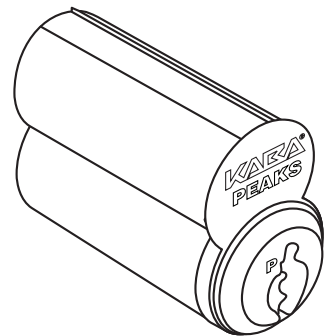

Timing pin engages slot in sleeve to create positive key pull stop for control key.

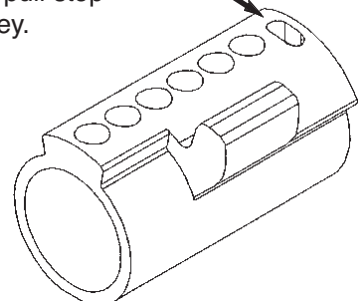

Rekeying

Pry off and discard the spring cover. Rekey, lubricate the cylinder with Poxylube®, and apply a new spring cover.

Since all Peaks products are designed to be top loaded, use of a follower for rekeying is optional.

Mortise/rim cylinder screws have a Loctite® coating. If cams or plug retainers are removed, use new screws and tighten them firmly.

The 8400/3400-xx-1006 kit security bushing

To prevent tailpiece detachment in certain locksets, the 3400-00-2009 security bushing must be applied to some 8400/3400 series key-in-knob cylinders. See Section 2 of this Manual for cylinder details.

Calculating Small Format Interchangeable Core – A2 System Pin Stacks

A2 system has ten depths numbered 0 to 9, shallow to deep, respectively. Two step progression must be used to prevent key interchange. In A2 system, parity must be maintained in each position, i.e., only the odd or even cuts may be used in a given pin chamber.

When a key system is written, the choice of a TMK automatically determines the parity pattern. Section 4 of this Manual has forms with all sixty-four parity patterns to use in maintaining a TMK register. This can also be done with a computer and data base program.

The operating and control shear lines are distinct in all positions. All the operating keys work at the plug (operating) shear line. Only the control key works at the control shear line.

Pin to the operating keys first. The shallow cut determines the bottom pin. A master pin makes up the difference between shallow and deep operating cuts. The numerical value of the bottom pin and master pin together is called the “plug total”. For example, a #3 bottom pin plus a #4 master pin results in a plug total of 7.

Buildup pins are added to the plug total to make the control key operate at the control shear line. Top pins are added to achieve a uniform pin stack height of 23 in all chambers.

Calculating the pin stack

1. Pin operating keys to the plug shear line.
The plug total equals the deep operating bitting.
2. Add 10 to control bitting. Subtract plug total.
The remainder is the buildup pin.
3. Add a top pin to bring the total pin stack to 23.

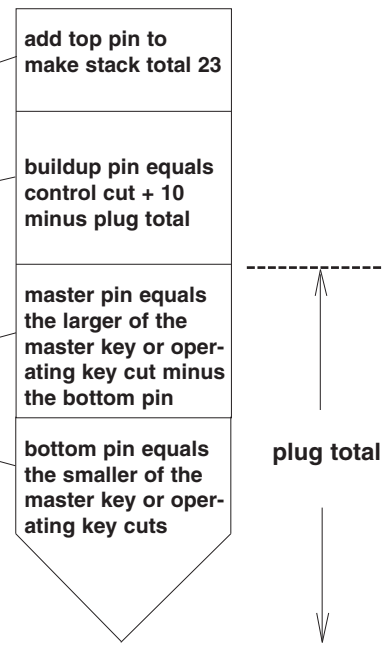

Non-original pins will not work properly in Kaba products and their use voids product warranty.

Calculating Other A2 Pinning Stacks

Comparing A2 Pin Stacks

The examples on this page show pinning for key symbol 1AA.

When pinning conventional cylinders, ignore the control biting. If a top pin of 20 or greater is needed, use two pins of equal length to bring the pin stack to the required height. When an odd numbered top pin is required, such as 21, use two pins that are close in size—11 and 10 instead of 13 and 8.

For the patent pin chamber in all conventional cylinders, insert the proper bottom and top patent pins, then insert a number 7B top pin.

Pinning for all Peaks products can now be accomplished with only one spring. That stainless steel spring is number 3800-00-4010.

Note: Peaks Preferred Patent Pins for illustration only. (See key pinning section 3 - 4 to 3 - 12)

control CTR 779631
 master AA 951473
 change 1AA 593875

Stack height 31

8401-xx-1210
 3401-xx-1210

Rim/Mortise

| | | | | | | | |
|---------|----|----|----|----|----|----|----|
| top | 11 | 11 | 14 | 12 | 12 | 13 | 7B |
| buildup | 11 | 11 | 14 | 11 | 12 | 13 | |
| master | 4 | 4 | 2 | 4 | - | 2 | |
| bottom | 5 | 5 | 1 | 4 | 7 | 3 | |

Stack height 23

8800/8900
 3800/6800

Small Format
 Interchangeable Core

| | | | | | | |
|---------|---|---|----|---|----|----|
| top | 6 | 6 | 4 | 7 | 10 | 12 |
| control | 8 | 8 | 16 | 8 | 6 | 6 |
| master | 4 | 4 | 2 | 4 | - | 2 |
| bottom | 5 | 5 | 1 | 4 | 7 | 3 |

Stack height 26

8400-xx-1206
 3400-xx-1206

Key-in-Knob

| | | | | | | | |
|---------|----|----|----|----|----|----|----|
| top | 17 | 17 | 12 | 18 | 19 | 11 | 7B |
| buildup | | | 11 | | | 10 | |
| master | 4 | 4 | 2 | 4 | - | 2 | |
| bottom | 5 | 5 | 1 | 4 | 7 | 3 | |

8400-xx-1299
 3400-xx-1299

"99" and "95" Key-in-Knob

| | | | | | | | |
|---------|----|----|----|----|----|----|----|
| top | 17 | 17 | 12 | 18 | 19 | 11 | 7B |
| buildup | - | - | 11 | - | - | 10 | |
| master | 4 | 4 | 2 | 4 | - | 2 | |
| bottom | 5 | 5 | 1 | 4 | 7 | 3 | |

8244-xx-1206 Yale

6240-xx-1206 Yale

6340-xx-1206 Medeco

| | | | | | | |
|---------|---|---|----|----|----|----|
| top | 9 | 9 | 7 | 10 | 13 | 15 |
| control | 8 | 8 | 16 | 8 | 6 | 6 |
| master | 4 | 4 | 2 | 4 | - | 2 |
| bottom | 5 | 5 | 1 | 4 | 7 | 3 |

8144-xx-1206

6140-xx-1206

Corbin Russwin

| | | | | | | |
|---------|---|---|----|----|----|----|
| top | 9 | 9 | 7 | 10 | 13 | 15 |
| control | 8 | 8 | 16 | 8 | 6 | 6 |
| master | 4 | 4 | 2 | 4 | - | 2 |
| bottom | 5 | 5 | 1 | 4 | 7 | 3 |

A2 System Small Format Interchangeable Core Pinning Charts

| | | | | | | |
|---------|---|---|---|---|---|---|
| Control | 9 | 6 | 0 | 4 | 7 | 8 |
| TMK | 5 | 2 | 8 | 6 | 1 | 4 |
| | 7 | 4 | 2 | 8 | 3 | 6 |
| | 3 | 0 | 4 | 0 | 5 | 2 |
| | 1 | 8 | 6 | 2 | 9 | 0 |
| | 9 | 6 | 0 | 4 | 7 | 8 |
| SOP | a | b | c | d | e | f |

A small format interchangeable core pinning chart is an expanded key biting array (KBA) that speeds pinning. At the left is a key biting array. The control combination is a change key that is set aside. SOP stands for Sequence of Progression.

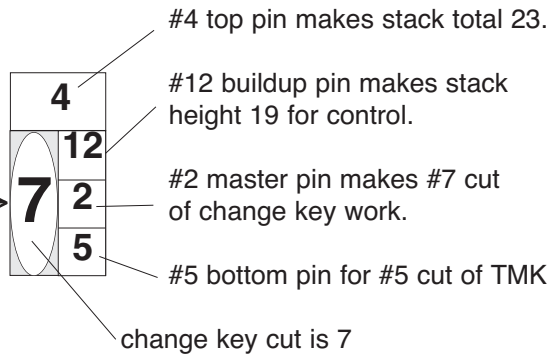

The inset at the left shows the pin stack for the first change key possibility in the first chamber.

The "7" from the KBA is in the large oval. To the right of the oval are the pins needed to make the #7 cut work with the #5 cut of the top master key and the #9 cut of the control key. Pin stacks are read from the bottom up.

| | | | | | | |
|-----------------------------------|---|---|----|---|---|---|
| top pins | 4 | 7 | 13 | 9 | 6 | 5 |
| | 7 | 4 | 2 | 8 | 3 | 6 |
| | 5 | 2 | 2 | 6 | 1 | 4 |
| | 3 | 0 | 4 | 0 | 5 | 2 |
| | 3 | 0 | 4 | 0 | 1 | 2 |
| | 1 | 8 | 6 | 2 | 9 | 0 |
| | 1 | 4 | 2 | 4 | 8 | 0 |
| | 9 | 6 | 0 | 4 | 7 | 8 |
| | 5 | 2 | 0 | 4 | 1 | 4 |
| complete pin stacks for constants | | | | | | |
| | 5 | 2 | 8 | 6 | 1 | 4 |
| | 5 | 2 | 8 | 6 | 1 | 4 |

The complete pinning chart contains every possible pin stack for every possible change key and master key in the system.

To pin a core to a given key, find the biting of the key in each position in the large oval and install the pins indicated in the squares next to the oval.

The bottom row beneath the heading "complete pin stacks for constants", gives complete pin stacks, including top pins, for the rotating constant method, or for pinning to master keys only.

Factory biting lists come with pinning charts. To make a pinning chart, fill in the large ovals with the cuts in the key biting array, and do the pin stack calculations one column at a time.

SKD's and cross keying

SKD's and cross keying cannot be pinned from this chart. SKD's are never master keyed. Cross keying must be calculated separately for each keying specification.

Calculating Small Format Interchangeable Cores A4 Pinning Stacks

A4 system has six depths numbered 0 to 5, shallow to deep, respectively. This is a single step progression system. Because there is no parity in the A4 system, key interchange between systems in the same keyway cannot be prevented.

The operating and control shear lines are distinct. All the operating keys work at the operating (plug) shear line. Only the control key works at the control shear line.

Pin to the operating keys first. The shallow cut determines the bottom pin. A master pin makes up the difference between shallow and deep operating cuts. The numerical value of the bottom pin and master pin together is called the "plug total." For example, a #1 bottom pin plus a #4 master pin results in a plug total of 5.

Buildup pins are added to the plug total to make the control key operate at the control shear line. Top pins are added to achieve a uniform pin stack height of 14 in all chambers.

The control dimension, or thickness of the control lug, is a multiple of the increment. The increment is 0.021" while the control dimension is 0.21". Because the control lug is 6 increment units thick, the control shear line is 6 units higher than the operating shear line.

Calculating the pin stack

1. Pin operating keys to the plug shear line. The plug total equals the deep operating bitting.
2. Add 6 to control bitting. Subtract plug total. The remainder is the buildup pin.
3. Add a top pin to bring the total pin stack to 14.

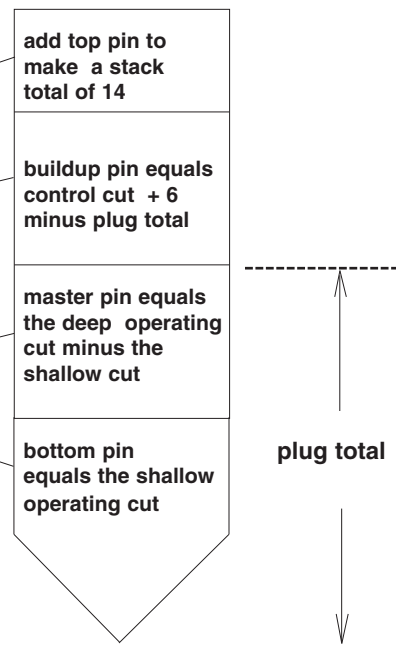

Non-original pins will not work properly in Kaba products and their use voids product warranty.

Calculating Other A4 Pinning Stacks

Comparing A4 Pin Stacks

The examples on this page show pinning for key symbol 1AA.

When pinning conventional cylinders, ignore the control bitting. If a top pin of 12 or greater is needed, use two pins of equal length to bring the pin stack to the required height. When an odd numbered top pin is required, such as 15, use two pins that are close in size—8 and 7 instead of 11 and 4.

For the patent pin chamber in all conventional cylinders, insert the proper bottom and top patent pins, then insert a number 4F top pin.

Pinning for all Peaks products can now be accomplished with only one spring. That stainless steel spring is number 3800-00-4010.

Note: Peaks Preferred Patent Pins for illustration only. (See key pinning section 3 - 4 to 3 - 12)

control CTR 153042
 master AA 204153
 change 1AA 315103

Stack height 18

8401-xx-1210
 3401-xx-1210

Rim/Mortise

| | | | | | | | |
|---------|---|---|---|---|---|---|----|
| top | 7 | 8 | 6 | 8 | 6 | 7 | 4F |
| buildup | 8 | 9 | 7 | 9 | 7 | 8 | |
| master | 1 | 1 | 1 | - | 5 | - | |
| bottom | 2 | 0 | 4 | 1 | 0 | 3 | |

Stack height 14

8800/8900
 3800/6800

Small Format
 Interchangeable Core

| | | | | | | |
|---------|---|----|---|---|---|---|
| top | 7 | 3 | 5 | 8 | 4 | 6 |
| control | 4 | 10 | 4 | 5 | 5 | 5 |
| master | 1 | 1 | 1 | - | 5 | - |
| bottom | 2 | 0 | 4 | 1 | 0 | 3 |

Stack height 15

8400-xx-1206
 3400-xx-1206

Key-in-Knob

| | | | | | | | |
|---------|---|---|----|---|----|---|----|
| top | 6 | 7 | 10 | 7 | 10 | 6 | 4F |
| buildup | 6 | 7 | - | 7 | - | 6 | |
| master | 1 | 1 | 1 | - | 5 | - | |
| bottom | 2 | 0 | 4 | 1 | 0 | 3 | |

8400-xx-1299
 3400-xx-1299

"99" and "95" Key-in-Knob

| | | | | | | | |
|---------|---|---|----|---|----|---|----|
| top | 6 | 7 | 10 | 7 | 10 | 6 | 4F |
| buildup | 6 | 7 | - | 7 | - | 6 | |
| master | 1 | 1 | 1 | - | 5 | - | |
| bottom | 2 | 0 | 4 | 1 | 0 | 3 | |

8244-xx-1206 Yale

6240-xx-1206 Yale

6340-xx-1206 Medeco

| | | | | | | |
|---------|---|----|---|---|---|---|
| top | 8 | 4 | 6 | 9 | 5 | 7 |
| control | 4 | 10 | 4 | 5 | 5 | 5 |
| master | 1 | 1 | 1 | - | 5 | - |
| bottom | 2 | 0 | 4 | 1 | 0 | 3 |

8144-xx-1206
 6140-xx-1206

Corbin Russwin

| | | | | | | |
|---------|---|----|---|---|---|---|
| top | 8 | 4 | 6 | 9 | 5 | 7 |
| control | 4 | 10 | 4 | 5 | 5 | 5 |
| master | 1 | 1 | 1 | - | 5 | - |
| bottom | 2 | 0 | 4 | 1 | 0 | 3 |

A4 Keying is not available for the 8444 series cylinders

A4 System Small Format Interchangeable Core Pinning Chart

| | | | | | | |
|---------|---|---|---|---|---|---|
| Control | 1 | 5 | 3 | 0 | 4 | 2 |
| TMK | 2 | 0 | 4 | 1 | 5 | 3 |
| | 3 | 1 | 5 | 2 | 0 | 4 |
| | 4 | 2 | 0 | 3 | 1 | 5 |
| | 5 | 3 | 1 | 4 | 2 | 0 |
| | 0 | 4 | 2 | 5 | 3 | 1 |
| | 1 | 5 | 3 | 0 | 4 | 2 |
| SOP | a | b | c | d | e | f |

A small format interchangeable core pinning chart is an expanded key bitting array (KBA) that speeds pinning. At the left is a key bitting array. The control combination is merely a change key that has been set aside.

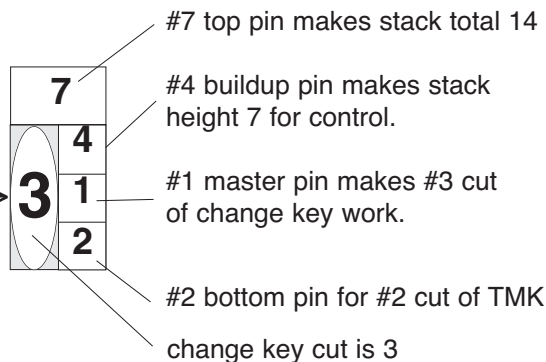

The inset at the left shows the pin stack for the first change key possibility in the first chamber.

The "3" from the KBA is in the large oval. To the right of the oval are the pins needed to make the #3 cut work with the #2 cut of the top master key and the #1 cut of the control key. Pin stacks are read from the bottom up.

| | | | | | | |
|--|---|----|---|----|---|---|
| top pins | 7 | 3 | 5 | 8 | 4 | 6 |
| | 4 | 10 | 4 | 4 | 5 | 4 |
| | 3 | 1 | 1 | 5 | 1 | 2 |
| | 2 | 0 | 4 | 1 | 0 | 3 |
| | 3 | 9 | 5 | 3 | 5 | 3 |
| | 2 | 0 | 0 | 1 | 1 | 3 |
| | 2 | 8 | 5 | 2 | 5 | 5 |
| | 3 | 3 | 1 | 3 | 4 | 3 |
| | 2 | 0 | 1 | 1 | 2 | 0 |
| | 5 | 7 | 5 | 1 | 5 | 5 |
| | 2 | 4 | 4 | 2 | 5 | 4 |
| | 0 | 0 | 2 | 5 | 4 | 3 |
| | 1 | 5 | 3 | 1 | 0 | 5 |
| | 1 | 5 | 5 | 3 | 1 | 4 |
| | 1 | 0 | 3 | 0 | 4 | 1 |
| | 1 | 0 | 3 | 0 | 4 | 2 |
| complete pin stacks for constants | | | | | | |
| | 7 | 3 | 5 | 8 | 4 | 6 |
| | 2 | 5 | 0 | 11 | 4 | 5 |
| | 2 | 0 | 4 | 1 | 5 | 5 |
| | 2 | 0 | 4 | 1 | 5 | 3 |

The complete pinning chart contains every possible pin stack for every possible change key and master key in the system.

To pin a core to a given key, find the bitting of the key in each position in the large oval and install the pins indicated in the squares next to the oval.

The bottom row beneath the heading "complete pin stacks for constants", gives complete pin stacks, including top pins, for the rotating constant method, or for pinning to master keys only.

Factory bitting lists come with pinning charts.

SKD's and cross keying

SKD's and cross keying cannot be pinned from this chart. SKD's are never master keyed. Cross keying must be calculated separately for each specification.



PEAKS[®] Preferred/Classic

Technical Manual

Section 4: Key Control &
Record Keeping



Introduction

Peaks contracts specify that:

1. The key blank identification number may not be removed, stamped-over, or altered in any way
2. Dealers can only duplicate keys bearing their own blank ID number, and must refuse to copy others
3. Only cut keys may be sold; key blanks may not be sold, lent or given away
4. Proper key records must be kept and authorization procedures observed

Poor record keeping can be a serious liability. Overall, end users respond favorably to professional record keeping practices when they understand that they exist for their protection.

Authorized Signature Registration Form

The Kaba key system authorized signature registration form records the key system's physical location and signature specimens of the persons authorized to order locks and keys from Kaba.

A completed authorized signature registration form is required to initiate any factory key system. It registers the system to a specific dealer and is used to verify signatures when subsequent orders are placed. To the right is a sample of an authorized signature registration form.

| KABA KEY SYSTEMS AUTHORIZED SIGNATURE REGISTRATION FORM | | | | |
|--|-------|---|---|------------|
| THIS ORIGINAL FORM MUST BE MAILED WITH YOUR CONTRACT BEFORE THE FIRST ORDER CAN BE PROCESSED. ** FAXED COPIES WILL NOT BE ACCEPTED ** | | | | |
| PROJECT INFORMATION: (to be completed by end user) | | | | |
| End User (please print or type) | | | Type of Facility (ie. University, Hospital, Mfg.) | |
| Street Address (no PO Box) | | City | State | Zip Code |
| End User Phone Number | | Distributor Name | | Keyway |
| AUTHORIZED OWNER SIGNATURE(S) | | | | |
| If restrictions are not indicated and in multiple signature cases, the first signature will be regarded as the primary authority able to control signers on this form. | | | | |
| 1. | | | | |
| Name (please print or type) | | Street (no PO Box) | | |
| Title or Position | | City | State | Zip Code |
| Signature | Date | Phone Number | | |
| 2. | | | | |
| Name (please print or type) | | Street (no PO Box) | | |
| Title or Position | | City | State | Zip Code |
| Signature | Date | Phone Number | | |
| 3. | | | | |
| Name (please print or type) | | Street (no PO Box) | | |
| Title or Position | | City | State | Zip Code |
| Signature | Date | Phone Number | | |
| DISTRIBUTOR OR LOCKSMITH AUTHORIZATION (OPTIONAL WITH OWNER AUTHORIZATION / SIGNATURE) | | | | |
| Distributor or Locksmith Company Name | | | System # | |
| Address (no PO Box) | | | | |
| City | State | Zip Code | Phone Number | Fax Number |
| Contact 1 (please print or type) | | | Contact 2 (please print or type) | |
| Contact 1 Signature | | | Contact 2 Signature | |
| *Note* If this form is to be used as a blanket authorization for a specific distributor or locksmith, please indicate distributor/locksmith's name below and the date for which this authorization will remain effective. (No more than one year) | | | | |
| Authorization Effective: _____ through _____ | | | | |
| Date | | Date | | |
| Owners Authorization By (please print or type) | | | | |
| Owners Authorization Signature | | | Date | |
| SPECIAL NOTE: In the case where the End User/Owner assigns the Distributor or Locksmith authorization (as noted above), the Distributor or Locksmith agrees to take full responsibility for validating the owners signature as identified on the Kaba Key Systems Authorized Signature Registration Form. | | | | |
| Please fill out a new Kaba Key Systems Authorized Signature Registration Form in the event of changes, additions or deletions in authorized signatures. Kaba Key Systems Authorized Signature Registration Forms are available from Kaba Key Systems or your local Kaba sales representative. | | | | |
| Please mail original to: | | Kaba Access Control Key Systems Department 2941 Indiana Ave. Winston Salem, NC 27105 | | |
| Rev. 11/07 | | | | |

Dealer Systems—Authorization Procedures

Always meet the minimum requirements for authorization on a Peaks system:

1. Know who the end user is
2. Know who has authority to order more locks or keys
3. Be able to prove that you have furnished locks and keys only to authorized persons

Authorization procedures for ordering Peaks keys and locks should be uniform and simple.

Here are some suggestions for procedures:

1. Obtain signed authorized signature registration form for all Peaks locks and keys
Check the signature on the purchase order against the authorized signature registration form on file
2. Use the Kaba form and obtain signatures upon receipt of Peaks locks and keys
The authorized registration form on file is used to confirm the identities of persons signing for materials

Adding/Deleting Names on the Authorized Signature Registration Form

1. Current Signatories

Only a person currently on the authorized signature registration form can add or delete others.

2. No Current Signatories

a. Declaration of Authority Letter

When the original persons on the authorized signature registration form are no longer available, then the only person authorized to add persons to the authorized signature registration form is the original signee on the contract. In any case, this person is not available, then a new contract must be signed and signatories can be added at that time, by filling out a new authorized signature registration form. This policy is to protect both the dealer and the factory from fraudulent claims of authorization. Contact Kaba if this authorized signature registration form is required.

Authorization Procedure

The Initial Order for a New Key System

Factory systems: Initial orders for factory master keyed product must be accompanied by a completed authorized signature registration form, which registers the key system with the factory. The order should be written using the industry standard key coding system and give keying expansion to help us properly design the key system.

Subsequent Orders Against an Existing Key System

The authorized signature registration form must be signed by an authorized signatory of the dealer before the factory can process the order. This form authorizes the factory to furnish Peaks keys or cylinders as requested. The factory will not accept faxes or photocopies of the authorized signature registration form.

Subsequent factory orders should be accompanied by a KABA order shipping form signed by an authorized signatory of the dealer, found on the authorized signature registration form provided earlier.

| KABA ORDER SHIPPING FORM | | | | | |
|--|--|----------------|--|----------------------|-------|
| THIS FORM MUST BE COMPLETED AND RETURNED BY THE END USER BEFORE THE FIRST ORDER WILL BE PROCESSED | | | | | |
| ORDER INFORMATION: | | | | | |
| Keyway: | | Key ID: | | Key System #: | |
| _____ | | | | | |
| Distributor: | | | | | |
| _____ | | | | | |
| SPECIAL INSTRUCTIONS: Please indicate any restrictions to authorized individuals listed on this form when purchasing additional Kaba products or duplicating keys. | | | | | |
| _____ | | | | | |
| _____ | | | | | |
| SHIPPING INSTRUCTIONS: | | | | | |
| It is the policy of Kaba to ship products directly to the End User/Owner to maximize the security of keys and cylinders. Be sure that the shipping address provided below includes the name of the specific individual in your organization to whom the keys and cylinders should be shipped to. | | | | | |
| COMPLETE ORDER | | | CYLINDERS/CUT KEYS: (CHANGE, GMK, MK, SELECTIVE) | | |
| SHIPPING ADDRESS: | | | SHIPPING ADDRESS: | | |
| Shipping Location Name | | | Shipping Location Name | | |
| _____ | | | _____ | | |
| Attention | | | Attention | | |
| _____ | | | _____ | | |
| Street (no PO Box) | | | Street (no PO Box) | | |
| _____ | | | _____ | | |
| City | | State | Zip Code | | |
| _____ | | _____ | _____ | | _____ |
| KEY BLANKS (ONLY) | | | BITTING LIST | | |
| SHIPPING ADDRESS: | | | SHIPPING ADDRESS: | | |
| Shipping Location Name | | | Shipping Location Name | | |
| _____ | | | _____ | | |
| Attention | | | Attention | | |
| _____ | | | _____ | | |
| Street (no PO Box) | | | Street (no PO Box) | | |
| _____ | | | _____ | | |
| City | | State | Zip Code | | |
| _____ | | _____ | _____ | | _____ |
| Kaba will ship to an alternate location only as directed by a designated signatory and with the understanding that the undersigned assumes full responsibility for the security and care of that material. Unless otherwise specified above, products will be shipped to the original End User/Owner address on file. | | | | | |
| SIGNATURE BLOCK | | | | | |
| I hereby authorize the above Kaba distributor to order material for the Kaba Key system above and I certify that I am the owner or authorized agent of the owner, of the Kaba patent protected key control system specified above and I am authorized to place the order. | | | | | |
| Authorized Signature | | | Date | | |
| _____ | | | _____ | | |
| PLEASE MAIL OR FAX TO: | | | KABA ACCESS CONTROL KEY SYSTEMS DEPARTMENT 2941 INDIANA AVE. WINSTON SALEM, NC 27105 www.kaba-access.com 800-849-8324 * 336-201-5519 fax | | |
| Rev. 11/07 | | | | | |

Dealer written key systems

Dealers should follow the same authorization procedures as Kaba for adding and deleting names on the authorized signature registration form.

Cross Keying

Cross Keying

Kaba Key Systems discourages cross keying of any sort. If Kaba Key Systems creates a key system, it is our intent to avoid cross keying totally if possible. If asked to generate a system with cross keying, we will generate that system as asked, but do know that Kaba Key Systems will not be held responsible for the integrity of the system when any cross keying is requested.



January 2008

Customer xyz
System # HXXX

We have received a request that your key system incorporate cross keying.

Kaba Key Systems strongly discourages cross keying. This condition could severely limit the security of the cylinder while minimizing the future expansion of the system. When a few different keys operate the same cylinder, or a few different cross keyed cylinders exist per system, then the integrity of the system is jeopardized.

As defined by (DHI) Door and Hardware Institute and (ALOA) Associated Locksmiths of America:

CONTROLLED CROSS KEYING - A condition where two or more different change keys, under the same higher level master key, operate one cylinder by design, e.g. XAA1 operated by AA2.

UNCONTROLLED CROSS KEYING - A condition in which two or more different keys under different higher level keys operate one cylinder by design; e.g. XAA1, operated by AB, AB1

Cross keying can be a deliberate process to combine a cylinder to two or more different keys which would not normally operate it. Kaba Key Systems discourages cross keying controlled and uncontrolled. Incorporating cross keying and /or selective keying into a key system will diminish system capacity.

By signing, dating and returning this form, you acknowledge you are in receipt of this notification and unless otherwise instructed, you wish to proceed with the cross keying as requested. Do understand that Kaba Key Systems will not be held responsible for the integrity of the system when any controlled or uncontrolled cross keying is requested.

(Signature)

(Date)

Thank you

Melissa Anderson
Key Systems Administrator

Kaba Access Control
2941 Indiana Ave.
Winston-Salem, NC 27105
Phone: 336-725-1331, Fax: 336-201-5519
www.kabaaccess.com

Writing the Key System Expansion Specification

Expansion information is essential for accurately planning a key system. Expansion should include the installed portion of the key system and planned future growth.

The key system expansion should be furnished in clear terms.

For example, a three level system may be described as follows:

Furnish a new grand master key system. Plan for a top control key. Provide for eight master keys with up to forty changes each. Provide for twelve changes directly under the grand master.

Or,

1 Grand Master x 1 Control x 8 Masters x 40 Changes / Master plus 12 Grand Changes

Questions regarding the design and generation of key systems may be directed to Kaba Key Systems.

KABA KEY SYSTEM INFORMATION FORM

Please use a separate form for each individual key system.

Specify (X): A2 System _____ A4 System _____

Product: _____ PEAKS 140 _____ PEAKS 150 6-pin _____ PEAKS 150 7-pin

Note: 150 Spacing for Peaks SFIC only

For Larger Systems

Multiplex keyways may be used to accommodate larger systems and expansion requirements necessary for future development. Plan your large systems wisely from the start; with the user of multiplex keyways the bittings are repeated on other key sections. Let the Kaba Key Systems Department decide how to apply keyways to best suit the job at hand based on the numerical expansion parameters.

Levels of keying—Specify (X):

____ 2 level system.

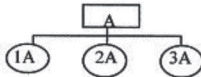

____ 3 level system.

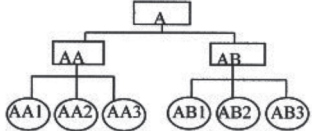

____ 4 level system.

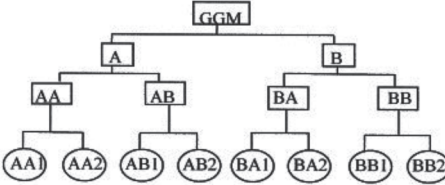

Selective Master Keys
 (ENG) Engineering Key
 (HSKP) Housekeeping Key
 (JAN) Janitor's Key
 (SEC) Security Key
 (GRND) Ground Key

Expansion Specification — the quantities of combinations needed at each level of keying:
 Please express in prose as in DHI Keying Manual or alphanumeric notation per ALOA's Fundamentals of Master Keying.

Specify any cross keying or non-standard keying required. (Cross keying is strongly discouraged)

The Standard Key Coding System

The following key symbols are the lock industry standard, used by manufacturers, BHMA, DHI and ALOA. They should be used when specifying any master keyed system. The symbols are constructed as follows:

| Abbreviation | Key type | Symbolized by | Symbols or "keysets" |
|--------------|------------------------|----------------------------|-----------------------|
| GGMK | great grand master key | GGM | GGM |
| GMK | grand master key | single letter | A, B, C, T |
| MK | master key | pair of letters | AA, AB, CC, BA, TR |
| CK | change key | letters and numbers | AA1, AB29, 17AA, SKD1 |

One level of keying—the most secure keying

Locks are never master keyed, but keyed alike (KA) or keyed different (KD). If you have two cylinders keyed to SKD1, it is a keyed alike group.



Two levels of keying—simple master key system

Consists of a Master and change keys. Master key is named with an identical pair of letters, AA, BB, CC, etc. The change key numbers go **in front of** the letter pair.

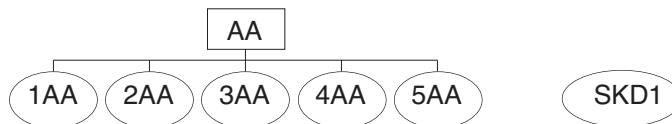

Three levels of keying—grand master key system

Consists of a Grand Master and multiple Master keys under the Grand. Change key numbers go **after** the letter pair. The first letter of the master key symbols is the grand.

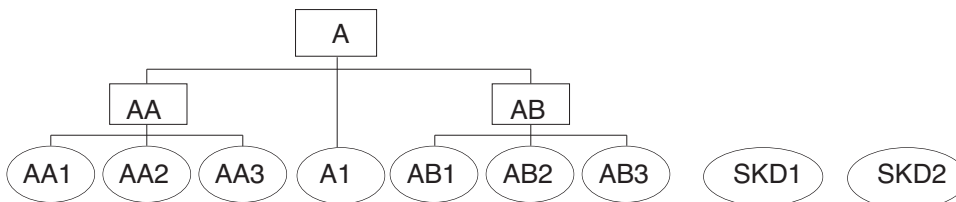

Four levels of keying—great grand master key system.

Consists of a Great Grand Master with multiple Grand Master "systems" under it. Change key numbers go **after** the letter pair.

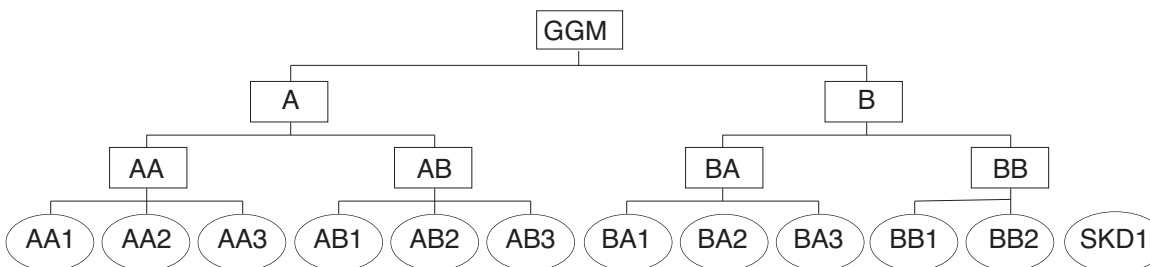

Special Symbols

Change keys directly under higher level master keys take the name of their associated master key and add numbers after the letter(s). SKD's, if used, are considered part of the system.

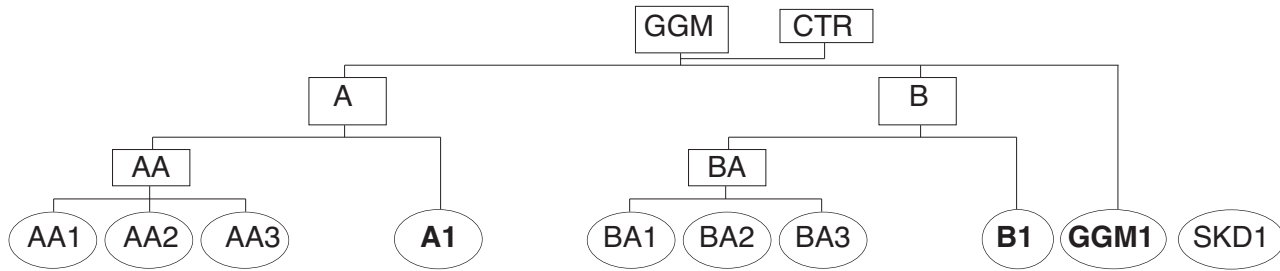

CTR is the symbol for a control key. A top control key, capable of operating all the cores in a system, is shown in the schematic at the same level as the top master key.

Cross keying

Although sometimes required, cross keying, either controlled or uncontrolled, should be discouraged. Cross keying greatly reduces the keying capacity of a system, severely limits the security of the cross keyed cylinder and makes the key system less flexible. Whenever possible, alternate solutions to cross keying should be explored.

If cross keying is required, each set's operating parameters need to be defined. The expressions can be written as follows:

XAA1 oby AA1, AA2, AA, A (oby = operated by)

X1X oby AC1 - AC5, AC10, AC, A

In the second example above, the "X" after the cylinder designation indicates that there is no change key (CK). It should be noted that cross keying requirements need to be defined at the time bittings are being generated. Cross keyed cylinders are labeled with the "X" symbol.

Additional Details

The letter "X" should not be used to designate a grand master. As stated above, this letter symbol is reserved for use in cross keying.

The letters I and O should be avoided for use as grand master or master key symbols as they are sometimes confused for numbers. To avoid confusion with O, Q should also be avoided.

For systems with more than twenty-four master keys under a given grand, the counting numbers are used between the letters of the pair. For example, A2A, A2B, A2C....A2Z are the symbols for master keys twenty-five through forty-eight.

SKD Combinations—Non-master Keyed Cylinders

SKD's Used in a Master Key System

The symbol SKD is used to indicate combinations in a master key system that are never operated by a master key. Typical uses are for securing personnel records, pharmacies, evidence rooms in police stations, etc., where SKD combinations provide greater security.

The key symbols SKD1, SKD2 and SKD3 represent different bittings. If you have three locks keyed to SKD1, you have a keyed alike group. It is for this reason that SKD does not mean single keyed different.

SKD sets are never master keyed; their combinations are derived outside of a master key system.

Non-master Keyed Cylinders—One Level of Keying

SKD is the standard symbol for one level of keying. Locks are either keyed-alike (KA) or keyed-different (KD). To prevent key interchange or repetition of SKD's, a bitting list can be generated under a selected parity pattern and the bittings crossed off the list as they are used.

Important Note:

Serious liability can arise by furnishing SKD's for different End Users under the same control key. Although this is convenient for servicing it is not an acceptable practice. Kaba treats SKD's under a single control key like a master key system.

Kaba Factory Bitting List Policy

A bitting list is a document showing all the key combinations used in a keying system. Possession of a bitting list imposes a serious responsibility for the integrity of the system. For these reasons, Kaba contracts designate the bitting list to be the property of the Dealer.

Since a bitting list requires the time and labor of a qualified professional to generate, a nominal fee will be charged for creating the list or for a transcript. This charge is in the factory price list.

Orders for bitting list transcripts are subject to the conditions of the specific key control contract and distribution channel.

Dealers and End Users ordering factory master keyed product in their contracted keyway, automatically receive a copy of the bitting list from Kaba. Requests for additional factory bitting list transcripts for End User keyways require a completed Kaba order shipping form with a designated signature matching one of those found on the Kaba key systems authorized signature registration form.

Designing Top Master Keys and Control Keys

The standards given below are used by the factory in designing and generating bitting lists. They apply to the top master key (TMK) in a system as well as the control key (CTR).

Design Standards

1. TMK's should have at least one of the shallowest possible bittings in one progressed position, and one of the deepest possible bittings in another position, whether it is progressed or not.

The purpose is to keep lower level keys from being cut down to the TMK or CTR bitting. The deepest possible cut statistically reduces key manipulation (key picking) as does a moderately deep constant.

2. Moderate cut-to-cut variations should be employed. Extremes in adjacent cut depths cause premature wear in the cylinder and on the key. Bittings of this type should be assigned last.
3. Uniformly shallow or deep keys should not be used. For example, 988789, is easy to pick, and any key in the system can be cut down to it. Uniformly shallow keys, like 120112, also make the locks easy to pick.
4. Declining step keys should be avoided. 976642 is an example of a declining step key. Such keys, when worn, tend to pull out of a turned plug and make the cylinder less pick-resistant.
5. Deep cuts next to the bow should be avoided as they can weaken a key. Kaba recommends that this position be progressed last in any key system to make all keys as strong as possible.

Control Keys (CTR)

The control key (CTR) should have the same characteristics as a top master key. The control key should normally differ from the top master key in all positions. The control key cuts are chosen from the progression columns of the KBA. The control is actually a change key. Note in the sample system that the key bitting array has been manipulated so that the control key is the last key in the system.

When you cross the control key combination off the progression list, you can be certain that no other key in the system will ever be a control key.

| | | | | | | |
|-----|---|---|---|---|---|---|
| CTR | 9 | 6 | 0 | 4 | 7 | 8 |
| TMK | 5 | 2 | 8 | 6 | 1 | 4 |
| | 7 | 4 | 2 | 8 | 3 | 6 |
| | 3 | 0 | 4 | 0 | 5 | 2 |
| | 1 | 8 | 6 | 2 | 9 | 0 |
| | 9 | 6 | 0 | 4 | 7 | 8 |
| SOP | a | b | c | d | e | f |

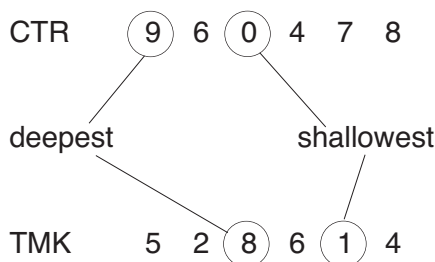

All systems should have different TMK's and distinct CTR combinations. TMK and control combinations should be recorded in a register to prevent repetition of the combinations. Kaba recommends that parity patterns be used to separate the master key systems from the KA and KD combinations for non-master keyed projects.

The TMK Register

The TMK register logs all top master keys and control keys by system register number to prevent duplication of systems. This type of register is kept by all manufacturers. Kaba maintains their logs by keyway, parity pattern and system location.

Example of TMK Register

| Mfr. | Key Section | TMK | Control | Parity | Location | Register # |
|---------|-------------|--------|---------|--------|-------------|------------|
| Corbin | 60 | 453263 | | Sys70 | Toledo | A012 |
| Dexter | 67 | 12212 | | OEEOE | Medina | A102 |
| Kaba | PEAKS-D | 836152 | | EOEOOE | Parma | A016 |
| Kaba | PEAKS-D | 793063 | 957405 | OOOEO | Bay Village | A015 |
| Kwikset | 1063 | 41363 | | none | Rocky River | A035 |
| Sargent | LA | 361794 | 363594 | OEOOOE | Bay Village | A013 |

Adding small & large format interchangeable cores to a system of conventional cylinders

Small format interchangeable core/large format interchangeable core cylinders can usually be added to a system of 140 conventional cylinders at any time. KABA recommends that you write a control key for all Peaks systems, so that if small format interchangeable core/large format interchangeable core is added later, the control key will be properly designed.

Visual Key Control (VKC)

Visual key control is the marking of the face of cores and cylinders with the symbols of the standard key coding system. From a security standpoint this is not a wise practice. If a key is found, a glance at the face of the cylinder would reveal what the key operates.

Do not stamp the plug face. This voids the warranty and may collapse the patent pin chamber.

Concealed Key Control (CKC)

Concealed key control is the marking of key symbols on the side or back of cores or cylinders. Kaba marks the key symbol on the side of the core with a permanent marker. In this way, when the core is recombined, the key symbol can be buffed off and no damage will be done.



PEAKS[®] Preferred/Classic

Technical Manual

Section 5: Cylinder Installation Guide



Introduction

This is an aid to selecting Peaks key-in-knob cylinders for grade 1 and 2 cylindrical locksets. It should be used in conjunction with Section 2 of the Peaks Technical Manual and your own library of competitors' catalogs and technical literature.

While there are many variations in trim designs, there is a finite offering of hardware. You will see the same few cylinder configurations used repeatedly.

The industry calls cylinders for both knob and lever trim "key-in-knob" cylinders. This document will use "handle" to mean the portion of the operating trim which contains the cylinder.

Key Demountable (KDH) versus Non-Key Demountable (Non-KDH) handles

To retrofit a cylindrical lock with Peaks, the handle must be removed to gain access to the cylinder. Some handles can be removed by turning an operating key and depressing a retainer.

Other locks require disassembly of the lockset and take more time to retrofit. This distinction is important when quoting labor for installation.

Tools

Basic hand tools are needed to service cylindrical locks, including standard and Phillips screw drivers, a plastic or rawhide mallet, and Poxylube® lubricant. Key demountable handles require a "poker" tool to depress the retainer. A 1/16" pin punch is an excellent tool for this purpose.

Spanner wrenches are required for all grade 1 knobs, and a few grade 1 levers. Grade 2 knobs and levers are normally mounted with concealed screws and do not require spanner wrenches.

Any tools beyond basic hand tools required for specific hardware will be listed below.

Finishes

North American hardware finishes for the plug face of key-in-knob cylinders are as follow:

for white finishes such as 625, 626, 628, 629, and 630: use Peaks satin chrome finish number 25; for all other finishes: use Peaks satin brass finish number 04.

Identifying the Manufacturer

The face of the latch is the first indicator of manufacturer. Certain brands of latch bolts and lock chassis are compatible. For example, occasionally an Arrow chassis will be seen with a Schlage latch bolt. When the knob or lever is removed, the appearance of the spindle cam, i.e., the cylindrical actuator into which the cylinder tailpiece fits, can be used to identify the chassis.



| Brand | Logo On Face | Notes |
|-------------------|--------------|--|
| Arrow | yes | "AMEROCK" and other OEM names have been used. |
| Corbin Russwin | yes | Prior to the brand merger in 1993, the individual brand names "CORBIN" or "RUSSWIN" were used. The Emhart logo, a capital E with horizontal arrows was used during Emhart's ownership. Some older unit locks have no trademark. |
| Falcon | yes | Falcon LY series grade 1 levers were imported from the same source as PDQ grade 1 levers and are sometimes confused. |
| LSDA | yes | Imported; house brand of the IDN companies. |
| Marks | yes | |
| PDQ | maybe | Latches for these locks bear check marks in a circle  (sic), and may be private labeled. Products assembled in the U.S.A. are marked "PDQ". |
| Sargent | yes | Product line numbers 6, 7, 8, 9, 10, 7600, etc. are stamped on the face. eg., a latch face marked "8" indicates an 8 Line lock. |
| Schlage | yes | Same key-in-knob cylinder body used throughout cylindrical lock line. Only the tailpiece shape and orientation vary. |
| Yale | yes | |

5-pin versus 6-pin

Older hardware may have 5-pin cylinders and no room in the handle to retrofit a 6-pin cylinder. Existing operating keys can be misleading. For example, some contemporary hardware is pinned to 5-pin keys, even though the cylinders have six pin chambers. This is referred to as "drilled 6, pinned 5". Try a 6-pin key blank in the cylinder. It will not seat fully in a 5-pin cylinder.

Cylinder Removal Methods

Key demountable handle (KDH): Remove cylinder by turning any operating key, depressing a retainer in the shank of the handle, and pulling on the handle.

Most contemporary cylindrical locks have key demountable handles.

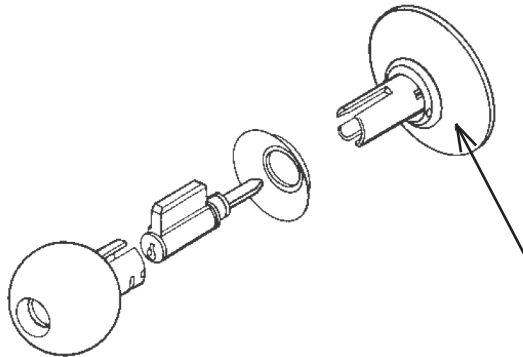

1. Turn any operating key to the right about 45 degrees.
2. Depress the retainer through the access hole in the trim, and pull off the knob.

Non-key demountable handle (Non-KDH): Remove cylinder by disassembling the lockset. Corbin Russwin and Sargent grade 1 knobs and preassembled locksets are the primary Non-KDH hardware.

| brand | grade 1 levers | grade 1 knobs | grade 1 preassembled | grade 2 levers | grade 2 knobs |
|----------------|----------------|----------------|----------------------|----------------|--------------------|
| Arrow | KDH | KDH | | KDH | KDH |
| Corbin Russwin | KDH | Non-KDH | Non-KDH | KDH | KDH/Non-KDH |
| Falcon | KDH | KDH | KDH | KDH | KDH |
| LSDA | KDH | KDH | | KDH | KDH |
| Marks | KDH | KDH | | KDH | KDH |
| PDQ | KDH | KDH | | KDH | KDH |
| Sargent | KDH | Non-KDH | Non-KDH * | KDH | KDH |
| Schlage | KDH | KDH | | KDH | KDH |
| Yale | KDH | KDH | KDH | KDH | KDH |

NOTES:

*Sargent discontinued their unit lock decades ago. However, they also made a lock called the "IntegraLock" (7600 Line) that used a small mortise body with through-bolted key-in-knob trim.

Arrow Architectural Hardware

Division of Assa Abloy

- "ARROW" appears on the latch face.
- Basic hand tools required.

NOTES:

- Flexcore is available in small format interchangeable core only.
- Entire Arrow line is available prepped for small format interchangeable core.

| Arrow | H series grade 1 knobs & levers | J series grade 2 interconnected | L, M series grade 2 levers | M series grade 2 knobs | tubular deadlocks |
|-----------------|---------------------------------|---------------------------------|----------------------------|------------------------|-------------------|
| retrofit type | KDH | KDH | KDH | KDH | |
| Peaks Preferred | 8400-xx-1099 | 8400-xx-1099 | 8400-xx-1099 | 8400-xx-1099 | 8400-xx-1099 |
| Peaks Classic | 3400-xx-1099 | 3400-xx-1099 | 3400-xx-1099 | 3400-xx-1099 | 3400-xx-1099 |



Corbin Russwin Architectural Hardware

Division of Yale Security Assa Abloy

- Depending on the vintage, “CORBIN”, “CORBIN RUSSWIN”, “EMHART”, and “RUSSWIN” will all be seen on latch faces.
- Corbin Russwin’s proprietary profile core can be retrofit with Peaks 8144/6140 Rcore.

| Corbin old no. | Russwin old no. | Corbin Russwin (1993) | product | retrofit method | Peaks Preferred Peaks Classic |
|----------------|-----------------|-----------------------|---|---------------------|--|
| 700 | 900 | CL3200 | grade 1 levers | KDH | 8144 LFIC 6140 LFIC |
| na | na | CL3300 | grade 1 levers | KDH | 8400-xx-1099 3400-xx-1099 |
| 800 | 800 | CL3400, CL3600 | grade 1 levers | KDH | 8400-xx-1099 or 8144 LFIC 3400-xx-1099 or 6140 LFIC |
| na | na | CL3800 | grade 2 levers discontinued 9-97 (replaced by CL3900) | KDH | 8400-xx-1099 with OEM tailpiece 3400-xx-1099 with OEM tailpiece |
| na | na | CL3900 | grade 2 levers | KDH | 8400-xx-1055 3400-xx-1055 |
| 400 | 400 | CK4200 | grade 1 knobs | Non-KDH | 8400-xx-1004 or 8144 LFIC 3400-xx-1099 or 6140 LFIC |
| 6600 | 3400 | CK4400 | grade 2 knobs, import | KDH/ Non-KDH | in development |
| 300 | 500 | UT5200 | grade 1 unit locks | Non-KDH | 8400-xx-1004 or 8144 LFIC 3400-xx-1099 or 6140 LFIC |

TOOLS:

- Grade 1 levers CL3400 and CL3600, require #585F48 hex wrench for flanged nut on rose liner.
- Grade 1 knobs, CK4200, require spanner wrench and long nose Tru-Arc pliers.
- Replacement of pre-1972 cylinders requires purchase of Corbin Russwin cylinder driver #144F29.

Retrofitting Corbin Russwin CK4200 Grade 1 Knobs
current model, 1976 to date

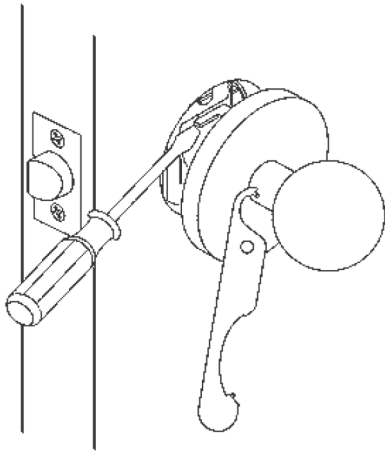

1. Loosen inside rose with spanner wrench; depress knob retainer.

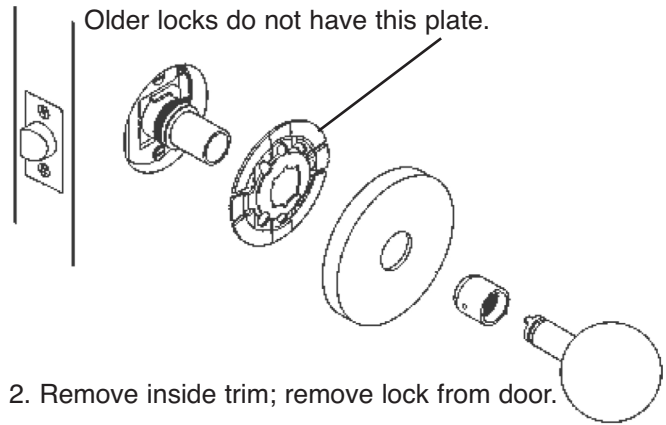

2. Remove inside trim; remove lock from door.

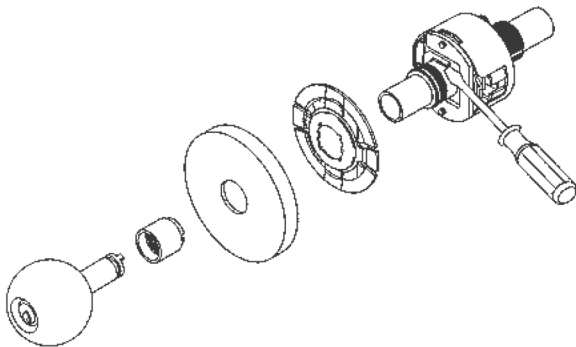

3. Depress outside knob retainer; remove outside knob.

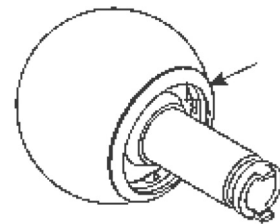

4. Remove knob cap if present.

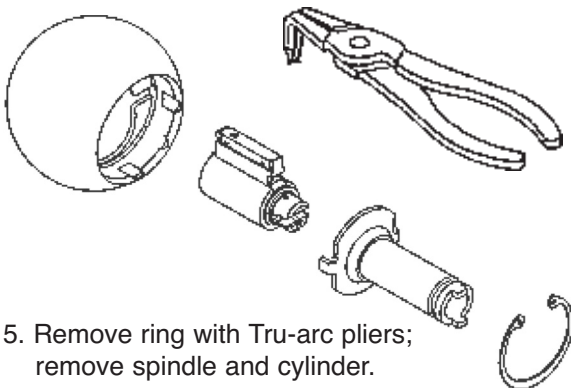

5. Remove ring with Tru-arc pliers; remove spindle and cylinder.

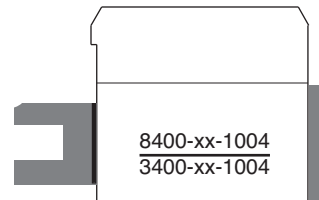

6. Install Peaks Preferred cylinder 8400-xx-1004 or Peaks Classic cylinder 3400-xx-1004 and reverse above steps.

Retrofitting Corbin Russwin CK4200 Grade 1 Knobs
models prior to 1976

Locksets made prior to 1976 were made with the outside knob retainer rigid. To remove the outside knob on pre-1976 locksets, remove one of the chassis screws completely, and loosen the other screw slightly. This will allow the knob retainer to pivot out of the spindle and permit knob removal.

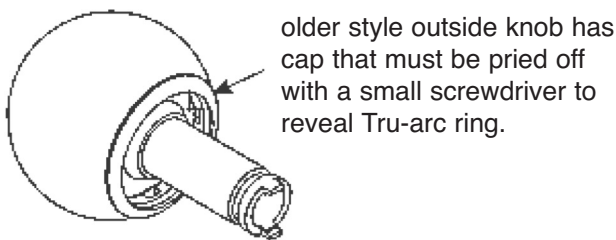
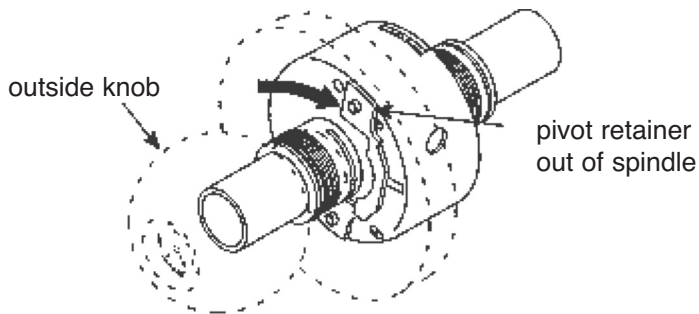
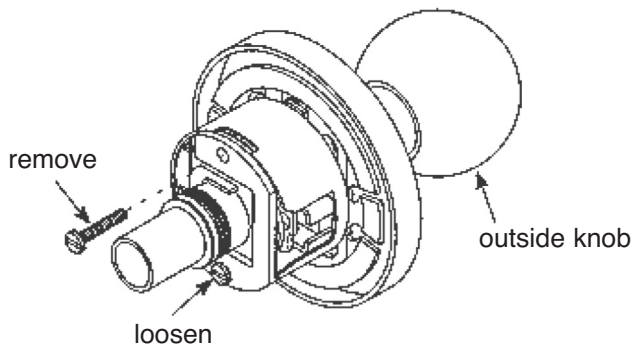

Falcon Lock Co.

Division of Ingersoll Rand

- "FALCON" appears on the latch face.

TOOLS:

- Spanner wrench is required for grade 1.
- $\frac{1}{16}$ " pin punch for depressing retainer.

| | | | | | |
|-----------------|--------------------------|------------------------|--|------------------------|------------------------------------|
| Falcon | LY series grade 1 levers | X series grade 1 knobs | RU and X series grade 1 unit lock preassembled | S series grade 2 knobs | D series tubular deadlocks/latches |
| retrofit type | KDH | KDH | KDH | KDH | |
| Peaks Preferred | 8400-xx-1099 | 8400-xx-1099 | 8400-xx-1099 | 8400-xx-1099 | 8400-xx-1095 |
| Peaks Classic | 3400-xx-1099 | 3400-xx-1099 | 3400-xx-1099 | 3400-xx-1099 | 3400-xx-1095 |

- 8400-xx-1095 is identical to 8400-xx-1099 and 3400-xx-1095 is identical to 3400-xx-1099, except for the small diameter plug face required for Falcon dead locks and old style X series unit locks.

Marks USA

Amityville, New York

- "MARKS" appears on the latch face.
- Grade 1 and 2 cylindrical locks can be prepped for small format interchangeable core.
- Current Marks deadbolts accept only 6-pin small format interchangeable core.

| | | | | | |
|-----------------|------------------------|-------------------|------------------------|-----------------------|---------------|
| Marks | 195/295 grade 1 levers | 180 grade 1 knobs | 170/270 grade 2 levers | 110/120 grade 2 knobs | 130 Deadlocks |
| retrofit type | KDH | KDH | KDH | KDH | |
| Peaks Preferred | 8400-xx-1099* | 8400-xx-1099* | 8400-xx-1099* | 8400-xx-1099* | 8400-xx-1099* |
| Peaks Classic | 3400-xx1099* | 3400-xx1099* | 3400-xx1099* | 3400-xx1099* | 3400-xx1099* |

*with original Marks tailpieces

TOOLS:

- Marks spanner wrench (engages entire rose) is required to install lockset, but not to change cylinders.

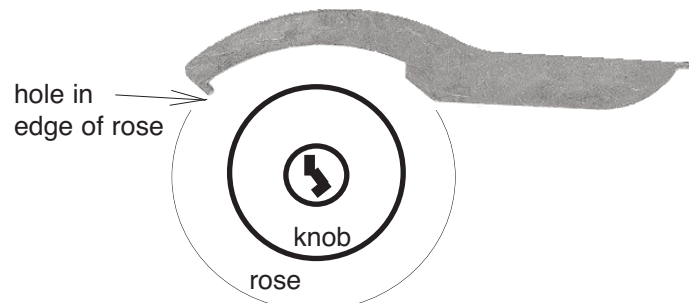

Sargent

Div. of Assa Abloy

"SARGENT" appears on the latch face.

Latch face bears a number indicating product line (6, 7, 8, 9, 10, etc.).
 Sargent 10 Line is identical to Arrow lever, except for small plug face diameter.

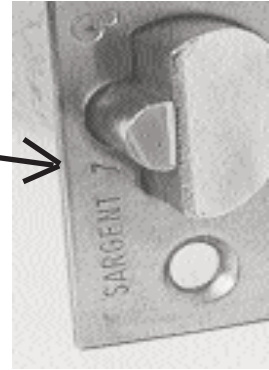

TOOLS:

7, 8 and 9 Line grade 1 knobs require a 3/32" hand held punch and mallet.
 10 Line grade 1 levers require Sargent bushing wrench, #10-0022.

| | | | | | |
|-----------------|-------------------------------|---------------------------|----------------------------|------------------------|--------------------|
| Sargent | 6 line grade 2 non-Ball knobs | 6 Line grade 2 Ball knobs | 7, 8, 9 Line grade 1 knobs | 10 Line grade 1 levers | 5500 grade 2 knobs |
| retrofit type | KDH | KDH | <i>Non-KDH</i> | KDH | KDH |
| Peaks Preferred | 8400-xx-1095 | 8400-xx-1095 | 8400-xx-1008 | 8400-xx-1095 | 8400-xx-1095 |
| Peaks Classic | 3400-xx-1095 | 3400-xx-1095 | 3400-xx-1008 | 3400-xx-1095 | 3400-xx-1095 |

| | | | | |
|-----------------|--------------------------|-------------------|------------------------|-------------------|
| Sargent | 6500 Line grade 2 levers | 2000 exit devices | 7600 Line preassembled | tubular deadlocks |
| retrofit type | KDH | KDH | <i>Non-KDH</i> | |
| Peaks Preferred | 8400-xx-1095 | 8400-xx-1095 | 8400-xx-1076 | 8400-xx-1099 |
| Peaks Classic | 3400-xx-1095 | 3400-xx-1095 | 3400-xx-1076 | 3400-xx-1099 |

Sargent

Retrofitting Sargent 7, 8 and 9 Line grade 1 knobs

1. With spanner wrench, loosen inside rose and unscrew outside rose completely.

rose unscrewed

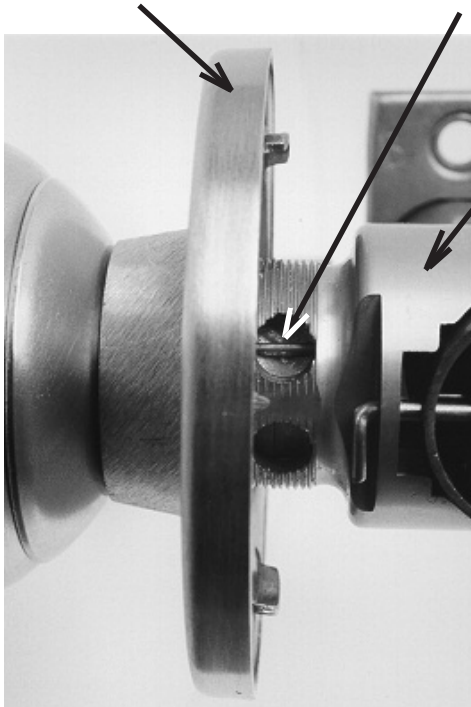

knob retainer spring visible through hole in aligner tube

aligner tube

2. Lock must be unlocked (outside knob free). If storeroom function, remove inside knob first per step 3. For other single cylinder functions, it is not necessary to remove inside knob.
3. Rotate knob and until knob retainer spring is visible in any hole threaded shank of aligner tube.
4. Depress knob retainer spring with small screwdriver. Pull out on knob and rotate back to rest position. Pull knob out of aligner tube.

5. Pry up nylon ring and remove knob collar.



6. Drive roll pin completely into knob with $\frac{3}{32}$ " punch and mallet.

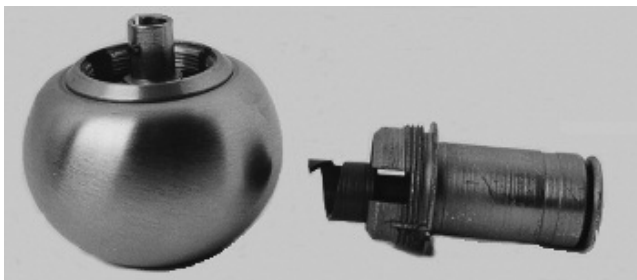

7. Unscrew spindle from knob. Slowly separate knob and spindle. Observe order of parts and save them, including the roll pin.



8. Replace cylinder with Peaks Preferred 8400-xx-1008 or Peaks Classic 3400-xx-1008. Reverse steps to reassemble. Do not reassemble with key in cylinder.

Schlage Lock Co.

Division of Ingersoll Rand

- “SCHLAGE” appears the latch face.

TOOLS:

- Spanner wrench is required for grade 1.
- Castlenut bushing wrench (included with new locks) is required to install AL grade 2 leversets, but not to change the cylinders.
- 1/16" pin punch for depressing retainer.

NOTES:

- Original S series tailpiece must be used in 8400-xx1099 or 3400-xx-1099 cylinder.

| Schlage | D series grade 1 knobs & levers | H series grade 2 interconnected | A, AL series grade 2 knobs & levers | S series grade 2 levers | E/B series tubular deadlocks/latches |
|-----------------|---------------------------------|---------------------------------|-------------------------------------|-------------------------|--------------------------------------|
| retrofit type | KDH | KDH | KDH | KDH | |
| Peaks Preferred | 8400-xx-1099 | 8400-xx-1099 | 8400-xx-1099 | 8400-xx-1099 | 8400-xx-1099 |
| Peaks Classic | 3400-xx-1099 | 3400-xx-1099 | 3400-xx-1099 | 3400-xx-1099 | 3400-xx-1099 |

Yale Security

Assa Abloy

- “YALE” appears the latch face.
- All grade 1 & 2 product is key demountable.*

TOOLS:

- 3400 grade 1 knobs require a spanner wrench.
- 3400L grade 1 levers require an 1/8" Allen wrench and an original Yale 5400L spanner wrench.

| Yale 5400L | 5400 grade 1 levers | 6200 Monolock grade 1 knobs | 5300L grade 1 unit lock preassembled | 5300 grade 2 levers | grade 2 knobs |
|-----------------|---------------------|-----------------------------|--------------------------------------|---------------------|---------------|
| retrofit type | KDH* | KDH | KDH | KDH | KDH |
| Peaks Preferred | 8400-xx-1055 | 8400-xx-1054 | 8400-xx-1054 | 8400-xx-1095 | 8400-xx-1054 |
| Peaks Classic | 3400-xx-1055 | 3400-xx-1054 | 3400-xx-1054 | 3400-xx-1095 | 3400-xx-1054 |

*The original 5400 Augusta Lever was non-key demountable. This lock was produced for only a few months and was redesigned to be key demountable.



Kaba Access Control
2941 Indiana Avenue
Winston-Salem, NC 27105 USA
Tel: (800) 849-8324 (336) 725-1331
Fax: (800) 346-9640 (336) 725-3269

www.kabaaccess.com

CAA1149 1209