

The National Locksmith®

• visit the online store •
TheNationalLocksmith.com

2001 Locksmith buyer's guide

manufacturers • page 8

distributors • page 64

schools • page 112

alarm monitoring • page 113

associations • page 114

web sites • page 120

inside: TNL book
& software catalog

On The Cover...

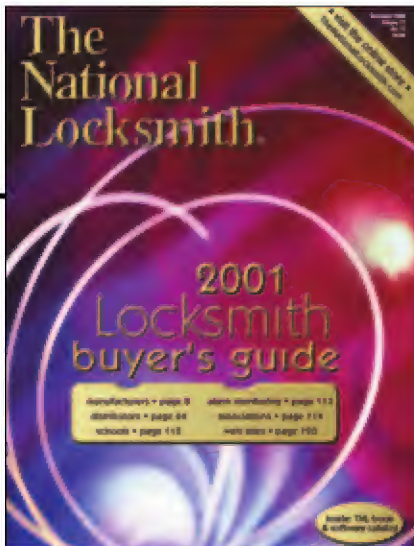

The National Locksmith's buyers guide is your passport to manufacturers, distributors, associations and a host of other useful contact information.

Publisher Marc Goldberg

Editor Greg Mango

Art Director Jim Darow

Technical Editor Jake Jakubowski

Senior Writers

Sal Dulcamaro CML, Michael Hyde, Dale Libby CMS, Dave McOmie, Sara Probasco

Contributing Writers John Blankenship, Tony Blass, Joe & Dee Bucha, Carl Cloud, Ron & Chris Curry, Richard Allen Dickey, Steve Gebbia, CML, Giles Kalvelage, Jim Langston, Tom Lynch, Tom Mazzone, Don Shiles, Robert Sieveking

Director of Sales & Marketing

Jeffrey Adair

Advertising Account Manager

Debbie Schertzing

Accounting Manager Sheila Campo

Production Assistants Kim Fryer
Dave Krofel
George Grumbos

Administrative Assistants Sean Selby
Jeffrey Thompson

Shipping Manager Allan Galvez

National Publishing Co.

The National Locksmith® ISSN #0364-3719 is published monthly by the National Publishing Co., 1533 Burgundy Parkway, Streamwood, Illinois 60107-1861. Periodicals postage paid at Bartlett, Illinois 60107 and additional mailing offices USPS 040110. Subscriptions \$41.00 per year in the USA; \$54.00 per year in Canada; \$67.00 in all other countries. Single copies \$5.00 each. Postmaster, please send change of address to National Publishing Co., 1533 Burgundy Parkway, Streamwood, Illinois 60107-1861. ©2000 by the National Publishing Company. All rights reserved. Printed in the U.S.A.



The Audit Bureau Member



Questions or problems with your subscription? (Or other inquiries?)

Call (630) 837-2044

Fax: (630) 837-1210

E-Mail: natlock@aol.com

See us on the World-Wide Web:
www.TheNationalLocksmith.com

CONTENTS

The National Locksmith December 2000 • Vol. 71, No. 12

FEATURES

- | | |
|--|--|
| 8
Manufacturer Listings | 120
Web Sites |
| 42
Listings of
Manufacturers by Product | |
| 64
Distributor Listings | 132
The National Locksmith
2000 Price Survey |
| 80
Listings of
Distributors by State | 144
The 1999
Jeep Grand Cherokee
<i>This vehicle underwent
a major re-design</i> |
| 88
Listings of
Distributors by Product | 149
Quick Entry
<i>2000 Daewoo Nubira</i> |
| 112
School Listings | 157
Corporate Safe Specialists
<i>Be Prepared for Anything</i> |
| 113
Alarm Monitoring Listings | |
| 114
Association Listings | |

DEPARTMENTS

- | | |
|----------------------------|-----------------------------|
| 5 COMMENTARY | 151 THE LIGHTER SIDE |
| 143 BUSINESS BRIEFS | 159 TECHTIPS |

COMMENTARY



Ho Ho Hole!

Last month Greg put on his thinking cap, dusted off his ninth grade geometry book, polished his protractor and chucked up a couple of drill bits. He then prepared to do battle with the foundation wall so we could finally fill Greg's Hole.

You may recall that the hole was dug so we could drill through the foundation wall and bury the incoming phone line. As the only guy in the office trustworthy with power tools, Greg kindly volunteered to do the job.

After a few short months of procrastination, Greg got to work. On the right you can see Spirit of Christmas Past appears in Greg's Hole.

No, the photo below isn't a recreation of the St. Valentine's Day Massacre, it's not even Greg's Rambo impersonation. Greg, worn and weary from doing battle, is shown moments after drilling the hole through the foundation, spelling the end of an era. Note the several extra holes scattered



Marc Goldberg



Have questions? Want free technical help?
Free Locksmith Forums!
www.TheNationalLocksmith.com

Marc Goldberg
Publisher

2001 Locksmith Buyer's Guide

Welcome to The National Locksmith's 2001 Locksmith Buyer's Guide. The following sections appear in this year's guide:

Manufacturers — An alphabetical listing of manufacturers that make products for the locksmith market.

Manufacturers by Product — In this easy to use cross reference, the manufacturers are listed by the type of products they make.

Distributors — An alphabetical listing of distributors that sell to locksmiths.

Distributors by State — In this easy to use cross reference, the distributors are listed by the state in which they are located.

Distributors by Product — In this easy to use cross reference, the distributors are listed by the type of products they stock and sell.

Schools — An alphabetical listing of locksmith correspondence and resident course schools.

Alarms — An alphabetical listing of alarm and alarm product manufacturers.

Associations — International, national and state locksmith associations listed by state.

Web Sites — A listing of web sites which can be accessed through the internet.

As always, we've tried to make this Locksmith Buyer's Guide complete with all the information you might need throughout the year. However, it is possible that some information might have inadvertently been omitted. We apologize, and ask that you send the missing or changed information to us in writing so that it may be included in our next upcoming guide. Send additions or changes to: The National Locksmith, 1533 Burgundy Parkway, Streamwood, Illinois 60107, Attn: Directory Changes.

As a closing note, the few manufacturers/distributors that do not include information following the product categories carry a range of products for the locksmith. Listings start on page 8.

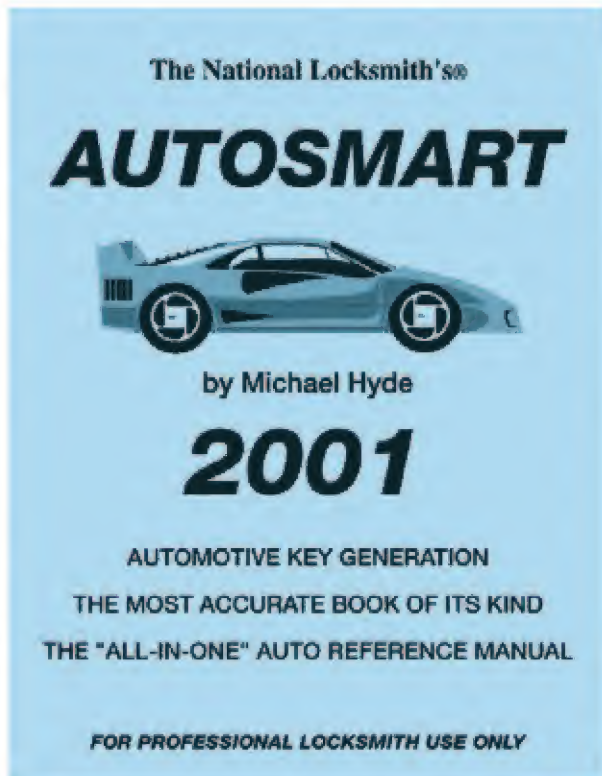

AutoSmart

A MUST
for every
locksmith!



[CLICK HERE TO LEARN MORE](#)

MANUFACTURERS

A&B Manufacturing Co. Inc.

1612 Meriden Waterbury Rd.
 Milldale, CT 06467
 860-628-5030
 William Olson

Product Categories: F G

A&B Safe Corp.

171 South Delsea Dr.
 Glassboro, NJ 08028
 800-253-1267, 856-863-1186
 Fax: 856-863-1208
 E Mail: INFO@A-BSAFECORP.COM
 Web: www.A-BSAFECORP.COM
 Edward Dornisch

Mildred (Sweetie) Dornisch
Product Categories: E F H
 See ad on page 33

A-I Security Mfg. Corp.

3001 West Moore St.
 Richmond, VA 23230
 877-725-2121, 804-359-9003
 Fax: 804-359-9415
 E Mail: FMCC @ demanda1.COM
 Frank McCarthy Pres.
 Rodney McClung, manager cust. Svc.
Product Categories: C G

Aable Locksmiths

86-19 97 Ave.
 Ozone Park, NY 11417
 718-847-1377
 Fax: 718-847-0991
 Frank Markisello RL Owner
 Elizabeth Markisello
Product Categories: B G

ABC Lock Co.

13747 192nd Ave.
 Council Bluffs, IA 51503
 402-598-5298
 Abe Parkins CEO
 Violeta Parkins Pres.
Product Categories: G

ABH Manufacturing

500 Crossen Ave
 Elk Grove Village, IL 60007
 847-437-9901
 Fax: 800-932-9224
 E Mail: abhinfo@abhmf.com
 Web: www.abhmf.com
 Janet Mollohan
 Kurt Shah
Product Categories: B F

Abloy Door Security

9500 Trans Canada
 Montreal QC, Canada
 L5T 1A7 H4S IR7
 800-465-5761, 514-335-9500
 Fax: 800-730-3570
 E Mail: info@abloy.ca
 Web: www.abloy.com
 Steve Timmons President
 Eric Gontovnick Comptroller
 Loretta Hans Customer Serv.
Product Categories: B F
 See ad on page 43

Abus Lock Co.

P.O. Box 47507
 Plymouth, MN 55447
 800-352-2287, 612-509-9933
 Fax: 612-509-9939
 E Mail: 74511.1570@compuserve.com
 Web: www.abus.com

George R. Hansen
Product Categories: F G
 See ad on page 37

Access Denied Inc.

P.O. Box 814
 Columbia City, IN 46725
 800-348-5115, 219-244-3692
 Fax: 219-244-4158
 E Mail: RJBAGAN@ULTRADOG.COM
 Web: www.ultradog.com
 Brian J. Rice Operatons Mgr.
 Richard Bagan Pres.
Product Categories: B F

Accu-Lock Inc.

P.O. Box 1114
 Burleson, TX 76028
 817-447-4085
 Fax: 817-447-6534
 E Mail: Rick@acculock.com
 Web: www.acculock.com
 Rick Segerstrom
Product Categories: F G H

Accurate Lock & Hardware Co.

Annie Pl
 Stamford, CT 06902
 203-348-8865
 Fax: 203-348-5234
 E Mail: accuratelj@aol.com
 Web: www accuratelockhardware.com
 Ronald M. Salvatore Pres.
Product Categories: B F

Adams Rite Manufacturing Co.

260 Sata Fe
 Pomona, CA 91767
 800-872-3267, 909-632-2300
 Fax: 909-632-2370
 Web: www.Adamsrite.com
 Dick Kreidel President
 Dare Orban, Director-Bus. Development
 Deon Arnold, Dir-Customer
 Satisfaction/CFO
Product Categories: B E F

Adapt-A-Bore

318 N. Milwaukee St.
 Milwaukee, WI 53202
 800-829-8905, 414-291-5684
 Fax: 414-291-5685
 E Mail: aspurich@execpc.com
 Web: www.doorhardware.net
 Andrew S. Pokrass
Product Categories: B F G

Adcour Inc.

P.O. Box 2649
 Woburn, MA 01888
 800-232-3557, 781-935-9944
 Fax: 781-937-3499
 Richard Jacobs
Product Categories: E

Adesco Safe Mfg. Co.

16720 S. Garfield Ave.
 Paramount, CA 90723
 800-821-6803, 562-630-1503
 Fax: 562-408-6427
 E Mail: sales@adesco.com
 Web: www.adesco.com
 Earl Halls President
 Kim Girard VP Sales
Product Categories: H
 See ad on page 115

Adrian Steel Co.

906 James St.

Adrian, MI 49221
 800-677-2776, 517-265-6194
 Fax: 517-265-5834
 Web: www.adriansteel.com
 Karen Poe Sales Coord.
Product Categories: G

Advance Car Mover Company

P.O. Box 1
 Juneau, WI 53039
 800-571-0136, 920-386-4464
 Fax: 920-386-4416
 David Courtney Pres.
Product Categories: G

Advanced Hardware Technologies

440 Fairmount Ave.
 Philadelphia, PA 19123
 800-523-9956, 215-629-0400
 Fax: 800-531-0844
 E Mail: TACOJ@AOLCOM.
 Web: www.TRANSATLANTICCO.COM
 Norman Millman
 Bernie Davis
 Donna Mcmonagle
Product Categories: B F

Advanced Safe & Lock

34762 Carter Street Rd.
 Lafargeville, NY 13635
 315-658-2368
 Dawn Smith

Advanced Signaling

P.O. Box 753
 Arlington, TX 76004
 817-275-8401
 Fax: 817-274-3707
 Steve Arnold
Product Categories: E

AerCom Tec International

1359 Silver Bluff Rd. #G5
 Aiken, SC 29803
 Kim Knight

Aero Lock

3675 New Getwell Rd. #9
 Memphis, TN 38118
 800-627-9433, 901-368-2147
 Fax: 901-362-1197
 E Mail: AERLOCK@IX.NETCOM.COM
 Web: www.aerolock.com
 David Parrott Owner
 Monika Parrott Owner
Product Categories: G

Aiphone Intercom Systems

1700 130th Ave. NE
 Bellevue, WA 98005
 800-692-0200, 206-455-0510
 Fax: 206-455-0071
 Web: www.aiphone.com
 John Mosebar Sales Mgr.
 Paul Hefty Tech. Support
 Joy Duffield Product Training Mgr.
Product Categories: E F
 See ad on page 15

PRODUCT CATEGORY KEY

A	—	Alarms
B	—	Architectural Hardware
C	—	Training Manuals & Materials
D	—	Locksmith Software
E	—	Electronic Security Products
F	—	Locking Products
G	—	Locksmith Tools & Equipment
H	—	Safes & Safe Products

Alarm Lock Systems Inc.

345 Bayview Ave.
Amityville, NY 11701
800-ALA-LOCK, 516-789-4871
Fax: 516-842-9137
E Mail: salesinfo@napcosecurity.com
Web: www.alarmlock.com
Brian Strom VP Alarm Lock Sales
Bob Swoope Natl. Sales Mgr.
Product Categories: E F

AlarmSaf

65 A Industrial Way
Wilmington, MA 01887
978-658-6717
Fax: 978-658-8638
E Mail: sales@alarmsaf.com
Web: www.alarmsaf.com
Gordon Pendleton VP Mktg.
Joe Holland VP Eng.
Barbara Hagan Cust. Svc. Sup.
Product Categories: E

All Secure & Safe Service

5530 W. 110th Street
Oak Lawn, IL 60453
888-815-3566, 708-423-2303
E Mail: allseckarl@msn.com
Karl Watson
Product Categories: H

All-Safe Security Systems Ltd.

Bay 3 6909 Fisher St SE
Calgary, AB
403-212-5660
Fax: 403-259-5110
E Mail: allsafe@allsafesec.com
Web: www.allsafesec.com
Werner Rossman
Product Categories: F G H

Allstate Insurance Co.

Allstate Plaza
Northbrook, IL 60062
800-669-6711, 847-402-8196
Fax: 847-326-7509
E Mail: ABISCO@ALLSTATE.COM
Web: www.allstate.com
Anita Bishop
Rick Nelson

Almont Lock Co. Inc.

P.O. Box 568
Almont, MI 48003-0568
810-798-8950
David Popovici Pres.
Arcadia Popovici CEO
Product Categories: F G
See ad on page 55

America Key Boxes

4100 Valley Trail
Kennedale, TX 76060
800-561-5397, 817-561-5397
Fax: 817-561-2881
E Mail: KEYBOX@FLASH.NET
Web: www.keyboxes.com
James E. Victory Owner
Josephine Victory Owner
Product Categories: G

American Auto Accessories Inc.

112-01 Northern Blvd.
Corona, NY 11368
800-THE-1800, 718-458-6200
Fax: 718-458-9110
E Mail: aaanyusa@aol.com
Web: www.3aracing.com
Henry Hsu Exec. Dir.
Ms. Betty Hsu VP
David Yu Mktg. Dir. Sales Mgr.
Product Categories: A F

American Lock & Key Co.

2110 Spencer Rd
Richmond, VA 23230
Barry Wilson

American Lock Co.

3400 W. Exchange Rd.
Crete, IL 60417
800-323-4568, 708-534-2000
Fax: 708-534-0531
Web: www.americanlock.com
Greg German VP Mktg
Tom Myers VP Sales
Bill Noone President
Product Categories: F

American Security Products Co.

11925 Pacific Ave.
Fontana, CA 92337
800-421-6142, 909-685-9680
Fax: 909-685-9685
E Mail: sec@amsecusa.com
Web: www.amsecusa.com
Frank Cademartori Pres.
Robert E. Sallee VP
Product Categories: E H

American Tolkey & Die

7226 W. Colonial Dr., #205
Orlando, FL 32818
888-695-8365, 407-327-2012
Fax: 407-327-2074
E Mail: amtolkey@bellsouth.net
Web: www.tolkey.com
Product Categories: G

Americorp International

2309 Airport Rd.
Waterford, MI 48327
248-674-8000
Fax: 248-674-8050

Amoratech Inc.

P.O. Box 100
Shermans Dale, PA 17090
880-233-6126, 717-582-3819
Fax: 717-582-7549
E Mail: less@amoratech.com
Web: www.balliston-lube.com
Les Moyer
Product Categories: G H

AMSECO

236 E. Star of India Ln.
Carson, CA 90746
800-421-1096, 310-538-4670
Fax: 310-538-9932
E Mail: info@amseco-kai.com
Web: www.amseco-kai.com
Yutaka Odawara Pres.
Thomas Fessler VP Sales & Mktg.
Sergio Galvez Adv. Mgr.
Product Categories: A E

Amtel Security Systems

1691 NW 107th Ave.
Miami, FL 33172
305-591-8200
Moe Weiner

AngioLaz Inc.

P.O. Box 556 Industrial Park
Bellows Falls, VT 05101
Marc Leveille

APR Industries Inc.

P.O. Box 342
Boonton, NJ 07005
800-729-2674, 973-983-0880
Fax: 800-646-8721
E Mail: info@aprusa.com
Web: www.Aprusa.com
Alan Paul Romanowicz VP

Sierra D'Arcy GM
Product Categories: A B C F
See ad on page 33

Architectural Control Systems Inc.

10666 Gateway Blvd.
St. Louis, MO 63132
800-753-5558, 314-432-5588
Fax: 314-432-2090
Dave Senften Pres.
Tony Caponi VP
Mark LeGrand VP
Product Categories: E
See ad on page 27

Armor Safe Technologies

2580 Progress St.
Vista, CA 92083
800-487-2766, 619-598-5470
Fax: 619-598-5471
E Mail: armorsafe@ixpres.com
Chuck Holycross Pres./CEO
Gary Wilkins VP Sales & Mktg.
Mike Staudt VP Engr.
Product Categories: H

Arrow Lock Mfg. Co.

10300 Foster Ave.
Brooklyn, NY 11236
800-233-0478, 718-257-4700
Fax: 718-649-9097
C. Thelin Pres.
Steven Pollack Mktg. Mgr.
Product Categories: A B F

ASSA

110 Sargent Dr.
New Haven, CT 06534-0435
800-235-7482, 718-927-2772 ext.450
Fax: 718-257-2772
Web: www.assalock.com
Henrik Hall Pres./C.E.O.
Bill Peterson Project Mgr.
Product Categories: B F

Audio Alert Systems

4208 Dover Rd.
Louisville, KY 40216
502-448-6699 Fax: 502-448-0018
Glenn Isaacs

Auto-Security Products (ASP Inc.)

P.O. Box 10
Redmond, WA 98073
425-556-1900
Fax: 425-558-1205
Web: www.carlocks.com
Buddy Logan Pres.
Dick Brandon VP
Steve Shain Nat'l. Sales Mgr.
Product Categories: F G

AutoSmart Advisor

1533 Burgundy Parkway
Streamwood, IL 60107
630-837-2044
Fax: 630-837-1210
E Mail: natllock@aol.com
Web: www.AutoSmartAdvisor.com
Michael Hyde
Marc Goldberg
Product Categories: D

PRODUCT CATEGORY KEY

- A — Alarms
- B — Architectural Hardware
- C — Training Manuals & Materials
- D — Locksmith Software
- E — Electronic Security Products
- F — Locking Products
- G — Locksmith Tools & Equipment
- H — Safes & Safe Products

Badge-A-Minit

P.O. Box 800
LaSalle, IL
800-223-4103, 815-883-8822
Fax: 815-883-9696
E Mail: questions@badgeaminit.com
Web: www.badgeaminit.com

Baldwin Hardware Corp.

P.O. Box 15048
Reading, PA 19612
800-437-7448, 610-777-7811
Fax: 610-775-5564
Anthony Sturuss Pres.
Rolin Sugg VP Tech. Svc.
Martin Van Doren VP Sales.
Product Categories: B F

Base Industries

254 Ott St. F
Corona, CA 91720
800-554-8088, 909-371-4465
Fax: 909-371-2828
E Mail: BASEBOY@EARTHLINK.NET
Scott Holmes
Brian Huitt Owner
Tony Gillett Tech. Supp.
Product Categories: C E F

Baton Lock & Hardware Co. Inc.

14275 Commerce Dr.
Garden Grove, CA 92643
800-395-8880, 714-265-3636
Fax: 714-265-3630
E Mail: batonlock@aol.com
Web: www.batonlockusa.com
Peace Hsu Pres.
David Roberson
Neli Prathima
Product Categories: B F G

Baumann Springs

PO Box 410167
Charlotte, NC 28241
704-588-2700
Fax: 704-588-8354
Dave Payunk Sales Manager

Belwith International Ltd.

P.O. Box 127
Grandville, MI 49468
800-235-9484, 616-531-4300
Fax: 616-531-2995
Mark D. Pelley Pres.
Robert E. Schaub VP Sales/Mktg.
Donald K. Pegel Dir. Mktg.
Product Categories: A F

Besam Automatic Door Systems

81 Twin Rivers Dr.
Hightstown, NJ
800-752-9290, 609-443-5800
Fax: 609-443-3440
Karen Maslow Admin. Mkg. Mgr.
Product Categories: E

Best Lock Corporation

P.O. Box 50444 6165 E. 75th St.
Indianapolis, IN 46250
317-849-2250
Fax: 317-595-7620

Best Power Technology Inc.

P.O. Box 280
Necedah, WI 54646
608-565-7200
Fax: 608-565-2221
Steve Paul Pres & CEO

BiLock North America Inc.

2420 Carson St. Suite 125
Torrance, CA 90501
800-328-7030, 310-328-7030
Fax: 310-328-7829

E Mail: BILOCK1
Web: www.bilock.com
Robert Vander Leek
Ken Stanton
Product Categories: F

Blackhawk Products

25913 Road T5
Dolores, CO 81323
970-882-7191
Fax: 970-882-7228
E Mail: staff2blackhawk7.com
Web: www.blackhawk7.com
Roger Weitzenkamp
Product Categories: D G

Bob Murray Safe & Vault Co.

339 Lena Avenue
Freeport, NY 11520
516-377-1760
Fax: 516-377-1760
E Mail: bobmurray@yahoo.com
Bob Murray
Product Categories: H

Boggs Tool Processing & File Sharpening Co.

14100 Orange Ave.
Paramount, CA 90723
800-547-5244 outside CA, 562-634-1081
Fax: 562-634-0839
E Mail: C.BOGGS1@AOL.COM
Web: www.BoggsTool.com
Cheryl Boggs
Harry Boggs
Product Categories: G

Bramlett Siso Security Systems

1310 E. Orange Grove Blvd. Apt 120
Pasadena, CA 91104
800-441-1654
Fax: 818-441-1650
Carlotta Bramlett

Bridgeman Security Equip.

510 W. Washington Blvd.
Montebello, CA 90640
800-334-6060, 323-724-1284
Fax: 323-727-0236
Eric Mueller Pres.
Ken Young VP/Sales
Product Categories: F H

Buddy Products Locksmith Division

1350 S. Leavitt
Chicago, IL 60608
800-886-8688, 312-733-6400
Fax: 312-733-8356
E Mail: sdifiglio@att.net
Web: www.buddyontheweb.com
Vivian Chavez Director of Sales
Sandra Rivera Cust. Svc. Mgr.
Product Categories: H

Budget Lock & Key

6547 N. Academy #532
Colorado Springs, CO 80918
719-260-0399
Fax: 719-266-4367
Dennis Collins

Bulger Safe & Lock

11502 Lake City Way NE
Seattle, WA 98125
206-363-8797
Fax: 206-363-7073
Ben Bulger

BWDAutomotive -Alabama

1108 A Singleton Dr.
Selma, AL 36701
800-647-4926, 334-872-6526
Fax: 334-874-6011

Russell Alsbrook VP Aftermarket Sales
Anita Owens Assist. Sales Mgr
Product Categories: C F G

CalRoyal Products

2110 Tubeway Ave.
Commerce, CA 90040-1614
800-876-9258, 323-888-6601
Fax: 323-888-6699
E Mail: sales@car-royal.com
Web: www.car-royal.com
David Yashar
Kaye Yashar
Product Categories: B F

Canadian Flexi Drills

395 Steelcase Road East
Markham ON, Canada L3R 1G3
905-475-2571
Fax: 905-475-5259
E Mail: cdnflexi@istar.ca
Josh Wallace

Canadian Locksmith, The Magazine

137 Vaughan Rd.
Toronto Ont., Canada M6C 2L9
905-294-0660
Fax: 905-294-0394
E Mail: TCLARSIN@ICA.NET
Arnold Sintnicolaas Publisher
Product Categories: C

Canadian Safe Manufacturing

170 Chatham St
Hamilton Ontario, Canada L8P 2B6
800-267-7635, 905-528-7233
Fax: 905-528-7728
Bob Edwards
Bob Schofield
Mary Schofield
Product Categories: E F H

Can-Am Care

Cimetra Industrial Park Box 98
Chazy, NY 12921
518-846-8050
Fax: 518-846-8055
Julie Arel

Cannon Safe Inc.

9358 Stephens St.
Pico Rivera, CA 90660
800-242-1055, 562-692-0636
Fax: 562-692-7252
E Mail: mbaker@cannonsafe.com
Web: www.cannonsafe.com
Jesse Burgarin
Mike Baker
Product Categories: H

Cansec Systems Ltd.

3105 Unity Drive. Unit 9
Mississauga Ont., Canada L5L 4L2
905-820-2404
Fax: 905-820-0301
E Mail: SALES@CANSEC.COM
Web: www.cansec.com
Fred Dawber Pres.
Keith Saunders Dir. Dealer Dvlpmnt.
Product Categories: E

PRODUCT CATEGORY KEY

- A — Alarms
- B — Architectural Hardware
- C — Training Manuals & Materials
- D — Locksmith Software
- E — Electronic Security Products
- F — Locking Products
- G — Locksmith Tools & Equipment
- H — Safes & Safe Products



Car Openers Inc., The

P.O. Box 895
Ocoee, FL 34761
800-561-0443, 407-884-5689
Dawn Tusing
Tom Tusing
Product Categories: G

Cardkey Systems Inc.

1757 Tapo Canyon Rd.
Simi Valley, CA 93063
805-522-5555
Fax: 805-526-0064
Mike Wolpert President & CEO
Richard Kelly VP Domestic Sales
Edie Gelardi Mgr. Cust. Comm.
Product Categories: E

Cargolock

217 South Street
Elmhurst, IL 60126
800-929-4700, 630-516-9933
Fax: 630-516-0988
Web: www.cargolock.com
James Kinnucan
Product Categories: F

Carlson's Lock Service

9735 La Docena Ln.
Pico Rivera, CA 90660
562-862-5400
Fax: 562-949-4627
Bruce Carlson
Product Categories: B F

Cary Auto & Home Locksmith

107 Southwest Street
Cary, NC 27511
919-469-0456
Jonathan Herman

CCL Security Products

199 Whiting St.
New Britain, CT
800-733-8588, 860-229-6199
Fax: 860-223-7601
E Mail: PRESTOLOX@AOL.COM
Web: www.cclsecurity.com
Tom Melkus Mng. Dir.
Product Categories: B F

CH Casey Lock & Saw Company

4444 Summer Ave
Memphis, TN 38122
901-682-5625
Fax: 901-683-5387
Clyde Casey

Charlie's Lock Service

P.O. Box 720729
Houston, TX 77272
281-497-1817
Charlie Hill

**Chicago Lock Co. One of Comp
International Companies**

P.O. Box 200
200 Old Mill real
Maulding, SC 29662
800-445-3204, 864-297-6655
Fax: 864-294-9987
Web: www.nelnet.com
Larry Roddy
Product Categories: F

ClearStar Security Network

1140 University
Berkeley, CA 94702
510-841-4807
Fax: 510-841-7915
E Mail: INFO@CLEARSTAR.COM
Web: www.clearstar.com
Jay E. Long
Product Categories: D

Cobalt Manufacturing

Division of Meilink

103 Ranch Ct.
Argyle, TX 76226
877-824-1449, 940-240-1449
Fax: 940-464-1010
E Mail: watkinsc@gte.net
Craig Watkins Sr. National Sales
Manager
Product Categories: H

CodePro Manufacturing

238 N. May St.
Thunder Bay ON, Canada P7C 3R3
807-628-8100
Fax: 807-473-0913
Web: www.arclock.com
Gordon Gravelle

Coffres-Ford Gardex Inc.

41 JF Kennedy
St. Jerome, Quebec, Canada J7Y 4B5
Sydney Grubert

**Commercial Van & Truck
Equipment Inc.**

490 Huyler St. P.O. Box 2185
S. Hackensack, NJ 07606
201-440-3600
Fax: 201-440-2586
Frank Gati

Commercial Van Interiors

8840 St. Charles Rock Rd.
St. Louis, MO 63114
800-759-7477, 314-423-7477
Fax: 314-427-1525
Steve Kloessner Pres.
Mark Stegen VP
Product Categories: G
See ad on page 83

Computer Reset

9525 Skillman St.
Dallas, TX 75243
214-348-6484
Fax: 214-343-3150
E Mail: sales@c-reset.com
Web: www.c-reset.com
Richard Byron
Product Categories: G

**Computerized Security
Systems**

1020 W. 17th St.
Costa Mesa, CA 92627
Phil Wilder

**Computerlock Anti-Theft
Devices**

1252 Hornby St.
Coquitlam BC, Canada V3E 1C5
604-961-1280
Fax: 604-941-4957
E Mail: ballistic@bc.sympatico.ca
Web: www3.bc.sympatico.ca/cyberlock
Mike Poirier Pres.
Product Categories: F

**CompX Security
Products**

P.O. Box 200
Mauldin, SC 29662
864-297-6655
Fax: 864-297-9987
E Mail: INFO@NCLNET.COM
Web: www.nclnet.com
Dave Bowers Pres.
Scott James VP Sales & Mktg.
Larry Roddy Nat'l. Sales Mgr.
Product Categories: F

Concord Electronic Access

1303 53rd St. Unit 257
Brooklyn, NY 11219
888-972-6626, 718-972-5415
Fax: 888-962-6626
E Mail: CONCORDEL@AOL.COM
Morris Lebidg
Product Categories: A B E F

Continental Instruments

250H Executive Dr.
Edgewood, NY 11717
516-254-0044
Fax: 516-254-3043
John Banks

Continental Micro Inc.

P.O. Box 394
Park Ridge, IL 60068
847-692-3630
Fax: 847-318-6188
Thomas Swiderek Pres.
Lori Lane VP
Product Categories: G

Control Monitor Systems

5152 Bolsa Ave. Ste. 110
Huntington Beach, CA 92649
888-247-6768, 714-892-8277
Fax: 714-892-1438
Web: www.controlmonitor.com
Pete Byrne
Product Categories: E

**Corbin Russwin Architectural
Hardware**

225 Epicopal Rd.
Berlin, CT 06037
860-225-7411
Fax: 860-828-7266
Lawrence T. O'Toole VP Sales & Mktg.
Product Categories: B C D E F G

Corby Industries Inc.

1501 E. Pennsylvania St.
Allentown, PA 18103
800-652-6729, 610-433-1412
Fax: 610-435-1963
Glenn M. Matz Pres.
Tim Corby GM
Rich O'Donnell Mktg.
Product Categories: E

Cordex International Ltd.

827 W. 26th Ave
Vancouver BC, Canada V5Z 2E9
604-876-8795
Fax: 604-876-6793
E Mail: CORDEX@ATTCANADA.NET
Tibor Boroczki
Product Categories: F

Corkey Control Systems Inc.

846 Mahler Rd.
Burlingame, CA 94010
800-622-2239, 650-692-9495
Fax: 650-692-9410
E Mail: corkeyus@earthlink.com
Web: www.corkey.com
Lin Sedley Operations Mgr.,
Robin Walin Off. Mgr.
Product Categories: F

PRODUCT CATEGORY KEY

- A — Alarms
- B — Architectural Hardware
- C — Training Manuals & Materials
- D — Locksmith Software
- E — Electronic Security Products
- F — Locking Products
- G — Locksmith Tools & Equipment
- H — Safes & Safe Products

Cor-Tech Mfg. Inc.

411 W. Gabrielson Rd. PO Box 582
Luverne, MN 56156
800-649-2252, 507-283-9081
Fax: 507-283-9081
Corey Stratten President
Thomas Sterrets Sales Mgr.
Marlin Krachs Shop Foreman
Product Categories: F

Creative Commands Corp.

3121 Fujita St.
Torrance, CA 90505
310-530-1420
Fax: 310-530-9219
E Mail: cpathway@pacbell.com
Web: www.handytouch.com
Bruce Kuglin
Timothy Rohrberg
Product Categories: E

Crest Electronics, Inc.

3706 Alliance Drive
Greensboro, NC 27407
336-632-9388
Fax: 336-855-6676
Cowboy Fisher

Cross Country Motor Club

440 Mystic Valley Pkway.
Boston, MA 02155
617-396-8700
John McNeill

Cypress Computer Systems, Inc

1778 Imlay City Road
Lapeer, MI 48446-3206
800-807-2977, 810-245-2300
Fax: 810-245-2332
E Mail: sales@cypresscom.com
Web: www.cypresscom.com
Deanna Collison, Director of Marketing
Laurie Dount, Sales
Shane Collison, Sales
Product Categories: E

DALAX Inc. / H&L Simon Co.

1314 Huntington Dr.
Richardson, TX 75080
972-234-8009
Fax: 972-234-0339
E Mail: SIMON@SIMON-SAYS.NET
Web: www.simon-says.net
Laurence D. Simon
Helen H. Simon Sec./Treas.
Product Categories: D

Darex Corp.

P. O. Box 277 220 E. Hersey
Ashland, OR 97520
800-547-0222, 541-488-2224
Fax: 541-488-2229
E Mail: kari@darex.com
Web: www.darex.com
Kari Guentner
Product Categories: G

Darex Professional Tool Corp.

P.O. Box 730
Ashland, OR 97520
Russ Johnson

Data-Basics

9450 Midwest Ave.
Cleveland, OH 44125
800-837-7574, 216-663-5600
Fax: 216-663-5454
E Mail: SAM@DATABASIC.COM
Web: www.databasic.com
Jean Knox
Art Divell
Tim Carcione
Product Categories: D

Dayton Safe Company

1803 A Webster St.
Dayton, OH 45404
800-337-9637, 937-461-3900
Fax: 937-461-4044
E Mail: daysafe@aol.com
Sara Nagler Pres.
Elliot Nagler GM
Product Categories: H

Deadbolt Anchor Co.

P.O. Box 2151
Claremore, OK 74018
Brad Francis

Decoy Safe Co.

323 N. Ivey Ln.
Orlando, FL 32811
800-972-1850, 407-295-1288
Fax: 407-295-1202
E Mail: PCURTIS@DSC.NET
Web: decoysafe.com
Peter Curtis
Product Categories: H

Dejoux Enterprises

1 Ayer Rd
Locust Valley, NY 11560
516-656-5651
Fax: 516-671-0491
E Mail: causekey@optonline.net
Web: www.causekeys.com
Morgan Dejoux

Deltaone Software

143 West Cerritos Ave.
Anaheim, CA 92805
Bob Hagar

DELT-REX Door Controls, LLC

593 New Park Avenue
West Hartford, CT 06110
860-233-8201
Fax: 860-233-8224
Kathleen Obrizzo Cust. Serv. Mgr.
Irving Saphirstein Sales Mgr.
Rich Retallack Product Mgr.

Dependable Security Inc.

1050 SE 135th Ave.
Portland, OR 97233
Lila O'neal

Detex Corp.

302 Detex Dr.
New Braunfels, TX 78130
800-729-3839, 830-629-2900
Fax: 830-620-6711
Web: www.detex.com
John Blodgett President
Greg Drake Nat'l Sales Manager
Trice Kastein Institutional Sales Manager
Product Categories: A B E F
See ad on page 65

Detroit Mini-Safe Co.

11984 N. Telegraph Rd. P.O. Box 135
Carelton, MI 48117
800-614-0099, 313-654-8080
Fax: 313-654-0045
Larry Arnold
Product Categories: F H

Diebold Inc.

P.O. Box 8230 Dept. 9-79
Canton, OH 44711
330-489-4000
Fax: 330-588-3794

DLA Security Systems Inc.

629 Kimball Ave.
Westfield, NJ 07090
908-233-7755
Fax: 908-233-7755
E Mail: dlasec@pipeline.com
Web: www.dlaco.com

Walt Driscoll Pres.
Product Categories: D

Doggett Locksmith

66 Boudinot Street
Trenton, NJ 08618
Charles Doggett

Domino Engineering Corp.

P.O. Box 376
Taylorville, IL 62568
800-736-6466, 217-824-9441
Fax: 217-824-3349
E Mail: domino@chipsnet.com
Web: www.dominoengineering.com
Larry Peterson
Product Categories: A E

Don-Jo Manufacturing

P.O. Box 929
Sterling, MA 01564
800-628-8389, 978-422-3377
Fax: 978-422-3467
E Mail: DON-JO@DON-JO.COM
Tim Roy VP
Karen Martin Oper. Mgr.
Peter Vaillant Nat'l. Sales Mgr.
Product Categories: B G

Door & Jamb Sec. Canada Ltd.

79 Woodborough Rd. SW
Calgary Alberta, Canada T2W 5C2
403-251-2694
Robert Madlener

Door Aid Corp.

7700 Sprinkle Rd.
Portage, MI 49002
800-493-8377, 616-324-5978
Fax: 616-324-5983
Tom Ford
Product Categories: B

Door Controls Int'l.

2362 Bishop Circle E
Dexter, MI 48130
800-742-3634, 734-426-0400
Fax: 800-742-0410
E Mail: sales@doorcontrols.com
Web: www.doorcontrols.com
Joseph A. Ghergo VP Sales
Barbara S. Maynard VP Marketing
Product Categories: A B E F

Door Motion Technologies

6285 High Pointe Cr.
Kalamazoo, MI 49024
800-291-1561, 616-321-9330
Fax: 616-327-6158
E Mail: DOORMOTION@AOL.COM
David Carambula Pres.
Product Categories: B E
See ad on page 47

Doorguard Systems Inc.

8970-C Route 108
Columbia, MD 21045
800-442-6247, 410-992-5600
Fax: 410-992-5694
E Mail: info@doorguardsystems.com
Web: www.doorguardsystems.com
C. T. Croson President
Harry Chaney Product Eng.
Product Categories: E F

DoorKing Inc.

120 Glasgow Ave.
Inglewood, CA 90301
800-826-7493, 310-645-0023
Fax: 310-641-1586
E Mail: INFO@DOORKING.COM
Web: www.doorking.com
Dusty Beeding Sales Dir.
See ad on page 47

Dorma Architectural Hardware/The DORMA Group N. A.

Dorma Drive
 Reamstown, PA 17567
 800-523-8483, 717-336-3881
 Fax: 717-336-2106
 E Mail: archdw@dorma-usa.com
 Web: www.dorma-usa.com
 Paul Kosakowski President
 Joel Sastow Dir. Mktg.
 John Bergstrom Dir. Sales
Product Categories: B E F

Dor-O-Matic a Division of Ingersoll-Rand

121 W. Railroad St.
 Princeton, IL 61356
 800-815-1517
 Fax: 800-666-0472
 E Mail:
Product Categories: A B E

Dremel

4915 21st St.
 Racine, WI 53406
 414-554-1390
 Fax: 414-554-7654
 Mike Brainerd Mktg. Serv. Mgr.
 Stephen J. Beardslee VP Sales
 Bridget Crave Mktg. Mgr. Rotary Tools
Product Categories: G

Dudley Inc.

544 Frontiere
 Hemmingford Quebec, Canada J0L 1H0
 800-363-1499, 450-247-3198
 Fax: 450-247-3341
 E Mail: dubleyco@cotal.net
 Louis LaPorte Pres.
 Laurent Denis Sales Mgr.
Product Categories: F

Dynalock Corporation

705 Emmett St.
 Forestville, CT 06011
 877-DYNALOCK, 860-582-4761
 Fax: 860-585-0338
 E Mail: DYNALOCK.CORP@SNET.NET
 Web: www.dynalock.com
 Ralph Sittnick Pres.
 John Schum Nat'l. Sales Mgr
 Kileen Mazzochi, Cust. Ser. Mgr.
Product Categories: E F

E.K. Ekessories Inc.

575 W. 3200 S.
 Logan, UT 84321
 800-338-2030, 801-753-8448
 Fax: 801-753-2411
 E Mail: EK@EKEKCESSORIES.COM
 Ed Kalbach Pres.

Eclipse, Inc.

1909 26th Street
 Boulder, Co 80302
 800-9-eclipse, 770-625-4995
 Fax: 770-625-4996
 E Mail: info@eclipseinc.com
 Web: www.eclipseinc.com
 Jessy Grasso

PRODUCT CATEGORY KEY

- A — Alarms
- B — Architectural Hardware
- C — Training Manuals & Materials
- D — Locksmith Software
- E — Electronic Security Products
- F — Locking Products
- G — Locksmith Tools & Equipment
- H — Safes & Safe Products

Andy Petro
 Susan Dickson
Product Categories: D

Eclipto Inc

3700 Mansell Rd., #220
 Alpharetta, GA 30022
 Jessy Grasso

Emergency Road Services Inc.

730 Paseo Carrillo
 Camarillo, CA 93010-6064
 805-379-3766, 805-495-8238
 John Osborne

EMTEK Products Inc.

15250 Stafford
 City of Industry, CA 91744
 800-356-2741, 818-961-0413
 Fax: 800-577-5771
 Tom Millar Pres.
 Rick Julian VP Mktg.

Don Wilkenson Cust. Svc. Mgr.
Product Categories: B F

Engineering Solutions Inc

6000 SouthCenter Blvd. #70
 Seattle, WA 98188
 800-995-2334, 206-241-9395
 Fax: 206-241-9411
 E Mail: chris@engsolinc.com
 Web: www.engsolinc.com
 Bob Merrill
 Chris Call
Product Categories: E F

Enixus Trade Ltd.

34 Dunkirk Rd.
 St. Catherines, Ont Canada L2R 1A1
 877-745-2715, 905-682-3086
 George Papaiz
 Bruno Papaiz
Product Categories: F

Modern Safe Opening

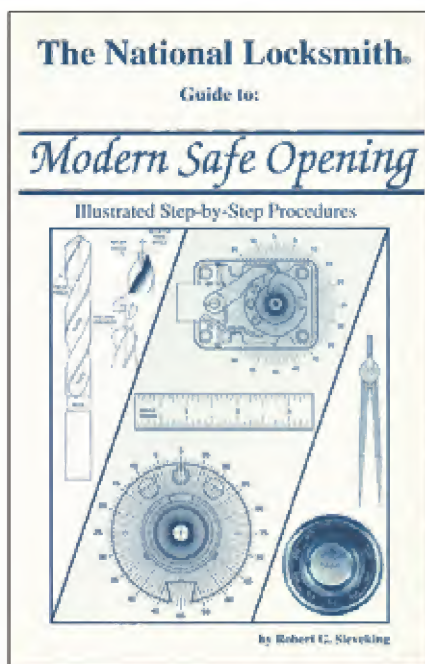

This book is a step-by-step How-To course in safe penetration. Opening safes is one of the most profitable aspects of the locksmithing business.

CLICK HERE TO LEARN MORE



#MSO - 1

Escalera Inc.

PO Box 1359
Yuba City, CA 95992
800-622-1359, 530-673-6318
Fax: 530-673-6376
E Mail: info@escalera.com
Web: www.escalera.com
Product Categories: H

ESP Lock Products

375 Harvard St.
Leominster, MA 01453
508-537-6121
Fax: 508-537-1699
Jeff Hudson Marketing Dir.
Sue Miller Sales Mgr.
Product Categories: F G

ESSEX Industries

1130 Mark Ave.
Carpinteria, CA 93013
800-539-5377, 805-684-7601
Fax: 805-684-0232
Michael Kaufman Dir. Sales & Mktg.
Product Categories: E F

Eternity Security Systems, Inc.

P.O. Box 1099
Laurence Harbor, NJ 08879
800-811-3991, 732-441-7701
Fax: 732-441-0612
E Mail: sales@eternalock.com
Web: www.eternalock.com
Ken Biba
Mike Wells
Product Categories: F

Everswitch

777 Passaic Ave.
Clifton, NJ 07012
973-779-8774
Fax: 973-779-8768
E Mail: alan@barantec.com
Web: www.barantec.com
Alan Gillasser Nat'l Sales Manager
Product Categories: E F

Exit Security Inc.

P.O. Box 8276
Fort Worth, TX 76124
800-446-6775, 817-429-6666
Fax: 817-831-2682
Ralph Roden
Product Categories: F

Falcon Lock

2650 Orbiter St.
Brea, CA 92821
800-266-4456, 714-572-6008
Fax: 800-777-8229
E Mail: info@falconlock.com
Web: www.falconlock.com
Bert Johnson AHC GM Sales Manager
Carrie Arnold Cust. Serv. Mngr.

Fan Dynasty Inc.

60-06 39th Ave.
Woodside, NY 11377
718-457-4691
Fax: 718-397-8502
E mail: roxfan98@yahoo.com
Web: www.Lock8.com
Roy Fan
Product categories: B F

Farfisa Intercoms

9600 NW 25th St.
Miami, FL 33172
800-806-0227, 305-593-0227
Fax: 305-593-9823
E Mail: FARFISA1@AOL.COM
Marcelo Paez General Mgr.
Product Categories: E

Federal Lock Company

21618 Marilla Street
Chatsworth, CA 91311
888-562-5565, 570-253-5424
Fax: 570-253-4292
Bob McDonough Nat'l. Sales Dir.
Product Categories: F

FingerSec

1111 Lincoln Rd., Ste 875
Miami Beach, FL 33139
Fabian Andrades

Finish Line Technologies Inc.

1545 Fifth Industrial Court
Bay shore, NY 11706
516-666-7300
Fax: 516-666-7391
Steve Dodge

Folger Adam Security Inc.

P.O. Box 25288
Charlotte, NC
800-438-1951
Fax: 740-283-2101
E Mail: mrobinson@yalesecurity.com
Michael T. Robinson National Sales Manager
Product Categories: B C E F

Fort Knox Security Products

1051 No. Industrial Park Rd.
Orem, UT 84057
800-821-5216, 801-224-7233
Fax: 801-226-5493
Web: www.ftknox.com
T.J. James Pres.
Product Categories: H

Fort Lock Corp.

3000 N. River Rd.
River Grove, IL 60171
708-456-1100
Fax: 708-456-9476
E Mail: info@fortlock.com
Web: www.fortlock.com
Jay Fine, Pres.
Larry Roddy, CSP Nat'l. Sales Mgr
Product Categories: A B C E G

Frame Inc.

578 S. State College Blvd.
Fullerton, CA 92831
800-372-6346, 714-441-0544
Fax: 714-441-0543
E Mail: FRAMEINC@JUNO.COM
Michael Murphy Sales Mgr.
Liz McClure Sales Asst.
Product Categories: E

Framon Manufacturing Company Inc.

909 Washington Ave.
Alpena, MI 49707
517-354-5623
Fax: 517-354-4238
E Mail: FRAMON@NORTHLAND.LIB.MI.US
Web: www.framon.com
Mike Agius VP
Ann Agius Sec. Treas.
Phil Agius VP Sales
Product Categories: G

Fred Silver Company

145 Sussex Ave
Newark, NJ 07103
800-322-5929, 973-621-8848
Fax: 973-621-8037
E Mail: thnkmirror@aol.com
Web: www.fredsilver.com
William Saydah

Frontier Safe Co.

3201 S. Clinton St.
Fort Wayne, IN 46806
800-461-6131, 219-744-7233
Fax: 219-744-6678
E Mail: MARC@FRONTIERSAFE.COM
Web: www.frontiersafe.com
Marcus Brewer Pres.
Dennis D. Dan Sales/Cust. Svc.

Gainsborough Hardware Ind. Inc.

1255 Oakbrook Dr. Ste. C
Norcross, GA 30093
800-845-5662, 770-448-9000
Fax: 770-448-7070
Steve Jackson Pres.
Joe Welsh Nat'l. Acct. Mgr.
Cherlyn Swansey Sales Coord.
Product Categories: B

Gardall Safe Corp.

PO Box 30
Syracuse, NY 13206
800-722-7233, 315-432-9115
Fax: 315-434-9422
E Mail: mkoesteres@gardall.com
Web: www.gardall.com
Edward W. Baroody Pres.
Mark Koesterer Nat'l Sales Mgr
Andy Ash Dir. Training & Mktg. Svc.
Product Categories: H

Gator Tools

5030 Filarees Circle
Colorado Springs, CO 80917
719-591-8343
Fax: 719-550-0953
E Mail: duxpond@sprynet.com
Web: www.aduxpond.com
Steve Cormier
Product Categories: G

Gil-Ray Tools Inc.

P.O. Box 801
Bay City, MI 48707-0801
517-892-6870
Fax: 517-892-6870
E Mail: djdeuel@bigfoot.com
Web: www.angelfire.com/biz/GilRayToolsInc/
David Deuel
Product Categories: G
See ad on page 55

Global Door Controls

3428-D Vane Ct.
Charlotte, NC 28206
800-256-7377, 704-376-7655
Tony Battah

Global Safe Corp.

7040 W. Palmetto Park Rd., #4-442
Boca Raton, FL 33433
Harvey Brodach

Glynn-Johnson

P.O. Box 6135
Indianapolis, IN 46206
800-525-0336, 317-894-9440
Fax: 800-525-0337
Product Categories: B

Graffunder

59890 Smith Loop
LaGrande, OR 97850
541-962-7233
Fax: 541-962-0913
E Mail: grafsafe@eoni.com
Web: www.eoni.com/~grafsafe
Tonya Church
Product Categories: H

Granite Security Products Inc.

5216 David Strickland Rd.
Ft. Worth, TX 76119



817-561-9095
 Fax: 817-478-3056
 E Mail: BECKY@GRANITE SAFE.COM
 Web: www.graniteSafe.com
 Kyle Walters
 Becky Walters
Product Categories: E F H

Great Southern Security
 7403 Monticello Drive
 Villa Rica, GA 30180
 770-830-7999
 John Anderson

GT-85 International Inc.
 P.O. Box 21185
 St. Petersburg, FL 33742
 800-525-GT85, 813-522-7785
 Fax: 813-526-1234
 Jon G. Miller President
Product Categories: G

GTO Inc.
 3121 Hartsfield Rd.
 Tallahassee, FL 32303
 800-543-GATE, 850-575-0176
 Fax: 850-575-8912
 E Mail: gto@gtoinc.com
 Web: www.gtoinc.com.
 Joe Kelley, Pres.
 Wayne Payne Sr. VP
 Linda Williams Sales Dir.
Product Categories: E F

G-U Hardware Inc.
 11761 Rock Landing Dr. (M-6)
 Newport News, VA 23606
 800-927-1097, 757-873-1097
 Fax: 757-873-1298
 E Mail: G-U@G-U.COM
 Web: www.g-u.com
 Kevin McDaniel Mng. Dir.
 John Imbriale Cust. Svc. Spvsr
 Dan Alexander Nat'l Sales Mgr
Product Categories: B

Guardian Security Group
 5424 S. Tacoma Way
 Tacoma, WA 98409
 Doug Rich

Gun Vault
 2205 W. Lone Cactus Dr., Ste C21
 Phoenix, AZ 85027
 623-445-0309
 Fax: 623-445-0310
 Web: www.gunvault.com
 Thomas Loeff Chief Operating Officer
Product Categories: H

H.B. Ives
 62 Barnes Park North
 Wallingford, CT 06492
 203-294-4837
 Fax: 203-284-1460
 Steve Carletti VP Sales & Mkt.
 Stacey Callahan Director of Mkt.
 Lisa Osborne Mgr. Door Hdwe.
Product Categories: B F

Hager Hinge Co.
 139 Victor St.
 St. Louis, MO 63104
 800-325-9995, 314-772-4400

Fax: 800-782-0149
 E Mail: rbeavers@hagerhinge.com
 Stephen Tenholder VP Roton Sales
 Roger Beavers Product Mgr
 Sharon Rainwater Sales Adm.
Product Categories: B

Hammerlock Industries
 10120 Bird Rd.
 Miami, FL 33165
 800-755-8345, 305-552-8345
 Fax: 305-223-6097
 Web: www.HAMMERLOCK.COM
 Rob Hammer
Product Categories: F

Hampton Products International
 20155 Ellipse
 Foothill Ranch, CA 96210

800-562-5625, 949-472-4256
 Fax: 949-472-9657
 E Mail: kkelly@hamptonproducts.com
 Web: www.hamptonproducts.com
 Kim Kelley Pres.
 Bob Wilkosz VP
Product Categories: F

Hardware Technologies Ltd.
 205 E. Blackhawk Dr.
 Ft. Atkinson, WI 53538
 920-563-2626
 Fax: 920-563-4408
 E Mail: info@us.hoppe.com
 Web: www.us.hoppe.com
 Jeff Shilakis Pres.
 Rudy Kessler Prod. Mgr.
 Chris Hunnel Cust. Svc.
Product Categories: B F

Dave McOmie on Safe Locks

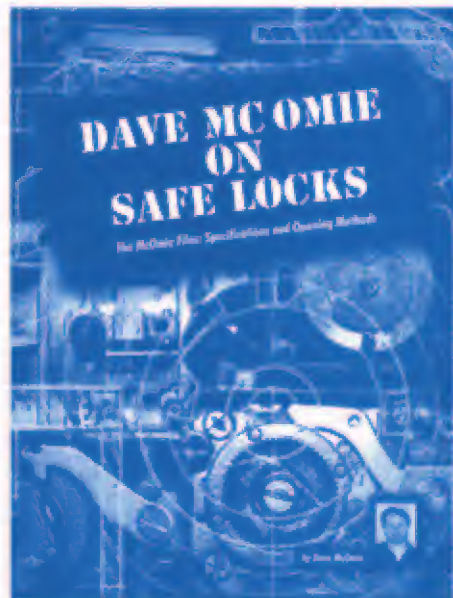

Almost 300 pages of information, photographs and illustrations give you every scrap of information about a huge variety of safe locks.

CLICK HERE TO LEARN MORE



#DMSL - 1

PRODUCT CATEGORY KEY	
A	— Alarms
B	— Architectural Hardware
C	— Training Manuals & Materials
D	— Locksmith Software
E	— Electronic Security Products
F	— Locking Products
G	— Locksmith Tools & Equipment
H	— Safes & Safe Products

MANUFACTURERS

Harper Manufacturing

3050 Westwood Dr
Las Vegas, NV 89109
702-735-8467
Tim Harper

Harrison Electronic Systems

51 Gravel St.
Wilkes-Barre, PA 18705
800-422-5050, 717-825-0540
Fax: 717-823-6343
E Mail: hesinc@ix.netcom.com
Web: www.harrison-hellfire.com
Karen Keefer
Griff Keefer CEO VPres.
Karen Haller, CFO
Product Categories: A E F

Hartford, The

P.O. Box 2908
Hartford, CT 06105
860-520-2915 Fax: 860-520-2264
Scott Newbury

Hayman Safe Co. Inc.

1295 S.R. 426
Oviedo, FL 32765
800-444-5434, 407-365-5434
Fax: 407-365-8958
E Mail: INFO@HAYMANSAFE.COM
Web: www.haymansafe.com
Gary Hayman Pres.
Bill Jacobs Sales Mgr.
Product Categories: H

Henry A. Evers Corp.

72 Oxford St.
Providence, RI 02905
800-553-8377, 800-55-EVERS, 401-781-4767
Fax: 401-781-9581
E Mail: everstamp@aol.com
Web: www.henryevers.com
Anthony J. Dilorio Pres.
Marjorie A. Smith, Sales Mgr.
Product Categories: G

Hercules Industries Inc.

Box 197 7194 St. Rt. 203
Prospect, OH 43342
800-345-2590, 740-494-2628
Fax: 740-494-2274
Web: www.brass-padlocks.com
Andy Tang Pres.
Dave Hook Plant manager
David P. Hook Dir. Of Oper.
Product Categories: F

HES Inc.

2040 W. Quail
Phoenix, AZ 85027
800-626-7590, 623-582-4626
Fax: 623-582-4641
E Mail: sales@hesinnovations.com
Web: www.electrictrikes.com or
www.hesinnovations.com
Michael A. Webb, Pres
Thomas Hertrich, VP Operations
Kit Anderson, Director of Marketing
Product Categories: E
See ad on page 108

HEWI Inc.

2851 Old Tree Dr.
Lancaster, PA 17603
717-293-1313
Fax: 717-293-3270
J. Hugh Rose Nat'l. Sales Mgr.
Product Categories: B

High Tech Tools

1400 SW 1st St.
Miami, FL 33135
800-323-8324, 305-649-7014

Fax: 305-541-0074
E Mail: sales@hightechtools.com
Web: www.hightechtools.com
Tony Vigil
Mirian Vigil
Silvio Baca
Product Categories: G C
See ad on pages 20 & 21

Hill Security Products

711 E. Walton Ave.
Spokane, WA
800-722-1142, 509-487-1142
Fax: 509-487-3166
Toki Miller Owner/Mgr.
Ruth E. Bower Exec. Asst.
Ilean Nelson Prod. Mgr.
Product Categories: G

Hilltrend USA Ltd. Inc.

140 Coastline Road
Sanford, FL 32771
407-328-1860 Fax: 407-328-1864
Chris Robertson

Hirsch Electronics Corp.

2941 Alton Parkway
Irvine, CA 92606
949-250-8888
Fax: 949-250-7372
E Mail: johnp@hirschelectronics.com
Web: www.hirschelectronics.com
L.W. Midland Pres.
Rob Zivney VP Mktg.
John Piccininni VP Sales
Product Categories: A E

Holmlund Lock & Key

1612 Tompy St.
Miles City, MT 59301
406-232-6764
Fax: 406-232-6061
Ken Holmlund

Horizon Safe Manufacturing Inc.

12819 Marquardt Ave
Santa Fe Springs, CA 90670-4827
800-320-3257, 562-698-0789
Fax: 562-945-4846
Jerry Bateman General Mgr.
Mike Kleman Sales Rep
Product Categories: H

HPC Inc.

3999 N. 25th Ave.
Schiller Park, IL 60176
800-323-3295, 847-671-6280
Fax: 847-671-6343
E Mail: HPC@HPCWORLD.COM
Web: www.hpcworld.com
Francine Hoffman VP-Mktg.
Jerry Hoffman President
Alan Blitstein VP-Sales
Product Categories: C D G H
See ad on page 2

Hudson Lock

260 West Ave.
Stamford, CT 06902
203-353-1200
Fax: 203-348-3473
Ted Gretjak
Product Categories: F

Hurd Corporation

503 Bohannon Ave.
Greeneville, TN 37744
423-787-8800
Fax: 423-787-8817
Steve Bone Pres.

Ilco Unican Corp.

Ilco Products Division
400 Jeffreys Rd.

Rocky Mount, NC 27804
800-334-1381, 252-446-3321
Fax: 252-446-4702
E Mail: info@rm.ilcounican.com
Mike Arrowood, Customer Service
Manager
Chuck Murray, VP Sales & Marketing

Ilco Unican Corp. Lock Division

2941 Indiana Ave.
Winston-Salem, NC 27105
800-849-8324, 336-725-1331
Fax: 336-725-3269
E Mail: info@win.ilcounican.com
Andrea Schwartz, Customer Service
Manager
Noel Flynn, VP Sales & Marketing
See ad on page 11

Ilco Unican Inc.

Unican Electronic Div.

730 Decaire Blvd.
Montreal, Que., Canada H4P 2G7
888-217-5654, 514-735-5410
Fax: 514-735-8862
E Mail:
commercial.sales@mtl.ilcounican.com
Travis Van Dort, Pre-Sales Support
Michael Incaid, VP Sales & Marketing

Ilco Unican Corp.

Mas Hamilton Division

805D Newtown Cr.
Lexington, KY 40511
888-950-4715, 859-253-4744
Fax: 859-281-5776
Web: mas-hamilton.com
Michelle Vaughn, Customer Service
Manager
Tom Rose, Marketing Manager

Illinois Lock Co./Div. of The Eastern Co

301 W. Hintz Rd.
Wheeling, IL 60090
800-733-3907, 847-537-1800
Fax: 847-537-1881
E Mail: sales@illinoislock.com
Web: www.illinoislock.com
Brian D. Reed Man. Dir.
Timothy Laabs Eng. R & D Mgr.
Product Categories: F

In-A-Floor Safe Co.

P. O. Box 1247
Thousand Oaks, CA 91358
800-437-9116, 805-493-9116
Fax: 805-493-0568
E Mail: inafloorsafe@juno.com
Carl L. Belknap
Esther M. Belknap
Product Categories: H

Indiana Cash Drawer Co.

1315 S. Miller St. P.O. Box 236
Shelbyville, IN 46176
800-227-4379, 317-398-6643
Fax: 317-392-0958
E Mail: cshergi@icdpos.com
Web: www.icdpos.com
Robert Benavides VP Sales & Mktg.
Catherine Shergi Sales Mgr.
Product Categories: E H

Industrial Precision Tool

73075 Deer Grass
Palm Desert, CA 92260
619-776-1897
Fax: 619-776-1899
Bill Johnstone

Industries CL Inc

9730 Boulevard Gouin West



Pierrefonds Quebec, Canada H8Y 1R5
 514-683-6282 Fax: 514-683-9015
 E Mail: clegault@legault-locks.com
 Web: www.legault-locks.com
 Sylvia Gomez
Product Categories: E

Info Graphic Systems Corp.

7373 Lincoln Way
 Garden Grove, CA 92841-1428
 714-220-4980
 Fax: 714-220-1828
 Doug Graham Exec. Director
 John Finamore V.P. Sales
Product Categories: E F

Innovative Moving Systems Inc.

P. O. Box 647
 Oostburg, WI 53070
 800-619-0625, 920-564-6272
 Fax: 920-564-2322
 Web: www.lectrotruck.com
 Steve Harrison Pres.
 Bill Harrison VP
 Elmer Hazen Sales Mgr.
Product Categories: H

InstaCode 200 I

1533 Burgundy Parkway
 Streamwood, IL 60107
 630-837-2044
 Fax: 630-837-1210
 E Mail: natlock@aol.com
 Web: www.TheNationalLocksmith.com
 John McMullen
 Marc Goldberg
Product Categories: D

Intellikey Corporation

551 S. Apollo Blvd. Suite 204
 Melbourne, FL 32901
 800-226-0703, 407-724-0700

Fax: 407-724-0811
 E Mail: INFO@INTELLIKEY.COM
 Web: www.intellikey.com
 Pino Baldassarre VP Operations
Product Categories: B D E F

Intelock

2701 Monarch St. #222
 Alameda, CA 94501
 Thomas Corder

Interactive Technologies Inc.

2266 N. Second St.
 N. St. Paul, MN 55109
 800-777-5484, 651-777-2690
 Fax: 651-779-4879
 E Mail: iti@ititechnologies.com
 Web: www.ititechnologies.com

Duane Paulson
 Reed Grothe
 Don Weber

Product Categories: A C E

International Electronics Inc.

427 Turnpike St.
 Canton, MA 02021
 800-343-9502, 617-821-5566
 Fax: 617-821-4443
 John Waldstein Pres./CEO
 H. Scott Kirkpatrick Dir. Sales & Mktg.
 Brad Sampson Prod. Mgr.
Product Categories: E

International Locking Devices Ltd.

104-4 Branford Rd.
 No. Branford, CT 06471
 800-863-9600, 203-481-6738
 Fax: 203-481-8490
 E Mail: ILD@TIAC.NET
 Web: www.gatelock.com

Bill Lalani Pres.
Product Categories: F
See ad on page 98

Intralock Tools Ltd.

Unit B 2639 Progressive Way
 Abbotsford B.C., CANADA
 V2T 6H8
 888-264-6627, 604-852-8904
 Fax: 604-852-8938
 E Mail: sales@intralock.bc.ca
 Web: www.intralocktools.com
 Gordon Parr Pres.
 Jim Brooks VP
Product Categories: G
See ad on page 73

Italbrass Corporation

21 Lime St.
 Marblehead, MA 01945
 617-639-1992
 Fax: 617-639-2458
 Dwight Jenning MG Oper.
Product Categories: B

ITI

P.O. Box 381
 Westfield, MA 01086
 413-562-3606
 Fax: 413-568-9809

PRODUCT CATEGORY KEY

- A — Alarms
- B — Architectural Hardware
- C — Training Manuals & Materials
- D — Locksmith Software
- E — Electronic Security Products
- F — Locking Products
- G — Locksmith Tools & Equipment
- H — Safes & Safe Products

MANUFACTURERS

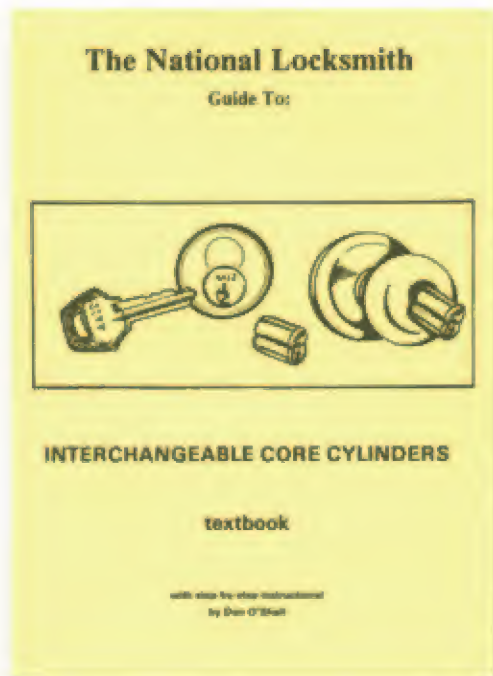

Interchangeable Core Cylinders

Covers all this...

- Best/Falcon/Arrow/Eagle/(A2)
- Best A3
- Best A4
- Corbin X Removable Core
- Corbin Z Removable Core
- Russwin Removable Core
- Emhart System 70 Removable Core
- Sargent Removable Core
- Schlage, Yale, Lockwood
- Medeco Removable Core

CLICK HERE TO LEARN MORE



#ICB - 1

J.J. Tourek Division Tuthill Corp

1800 Touhy Ave
Elk Grove Village, IL 60007
800-323-8172
Fax: 708-640-0158
Jim Eckert

Jado Bathroom & Hardware Mfg. Corp.

7845 E. Paradise Ln.
Scottsdale, AZ 85260
800-227-2734, 480-951-2675
Fax: 480-951-7165
Web: www.jado.com
Ken Moore VP
Product Categories: B

Jensen Tools Inc.

7815 S. 46th St.
Phoenix, AZ 85044
800-426-1194, 602-453-3169
Fax: 800-366-9662
E Mail: jensen@stanleyworks.com
Web: www.jensentools.com
Gary Treiber Pres.
Tom Nunes Natl. Sales Mgr.
Jen Hogg, Customer Suc. Mgr
Product Categories: G

Jet Hardware Mfg. Corp.

800 Hinsdale St.
Brooklyn, NY 11207
718-257-9600
Fax: 718-257-0973
E Mail: Keys@jetkeys.com
Web: www.jetkeys.com
Alfred Schonberger Pres.
Fred Lang VP
George Buchinger Sec./Treas.
Product Categories: F

KABA High Security Locks

P.O. Box 490 Old Turnpike Rd.
Southington, CT 06489
860-621-3601
Fax: 860-621-9727
Jack Hobin CPL Marketing and Technican
Training Mgr.
Product Categories: E F

Kaddies Inc.

P.O. Box 342
Walnut Creek, CA 94597
800-523-KADDIES, 925-934-4488
Fax: 925-934-4492
E Mail: tshettle@pacbell.net
Web: www.kaddiesinc.com
Tom Shetterly Nat'l Sales Mgr.
Product Categories: G

Keedex Inc.

12931 Shackelford Lane
Garden Grove, CA 92841
714-636-5657
Fax: 714-636-5680
E Mail: INFO@KEEDEX.COM
Web: www.keedex.com
Cormac "Mac" Dorsey VP/ GM
Julie McCluney President
George Hill Sec/Treas
Product Categories: B E G H
See ad on page 106

Keefe Lock Co.

1324 Parkside Avenue
Trenton, NJ 08638
609-882-2290
Fax: 609-882-1698
John Keefe
John R. Keefe
Product Categories: G

Kenstan Lock & Hardware Co.

101 Commercial St.
Plainview, NY 11803
800-859-7874, 516-576-9090
Fax: 516-576-0100
E Mail: KENSTAN@kenstan.com
Web: www.kenstan@kenstan.com
Hans Bosch Pres.
Bob Harrison VP Operations
Matty Youngs Sales Manager
Product Categories: F

Kent-Moore

28635 Mound Rd.
Warren, MI 48092
800-345-2233, 810-578-7218
Fax: 800-578-7375
Tom Riordan Pres.
Todd Downs Prod. & Prom. Coord.
Bill Clogg VP
Product Categories: G

Keri Systems Inc.

1530 Old Oakland Rd. #100
San Jose, CA 95112
800-260-5265, 408-451-2520
Fax: 408-441-0309
E Mail: sales@kerisys.com
Web: www.kerisys.com
Ted Geiszler Pres.
Dennis Geiszler VP Sales
Scott Lindley Mgr of RFID
Product Categories: E

Kett Tool Co.

5055 Madison Rd.
Cincinnati, OH 45227
513-271-0333
Fax: 513-271-5318
H. Rowe Hoffman Chairman
See ad on page 131

Key Control Specialists

34631 Peaceful Valley Rd.
Palmdale, CA 93551
805-538-1478
Fax: 310-640-8389
Melinda Gray
Product Categories: C D F

Key Pro Services

1331 E. Rockville Pike
Rockville, MD 20852
Sudhir Gupta

Key Systems Inc.

PO Box G
Fishers, NY 14453
800-888-3553, 716-924-7830
Fax: 716-924-3515
Web: www.keystorage.com
Product Categories: E H F

KEY-BAK; Div. of West Coast Chain Mfg. Co.

1460 S. Balboa Ave.
Onario, CA 91761
800-685-2403, 909-923-7800
Fax: 800-565-6202
E Mail: sales@keybak.com
Web: www.keybak.com
Craig Paugh Pres.
Boake Paugh VP
John Barcikowski, Sales Manager
Product Categories: E G

Keylink Keyrings

60 S Cunningham Rd
Thousand Oaks, CA 91362
805-497-3621
Fax: 805-374-8330
Lawrence Decker

KeySoft Masterkeying Software

P.O. Box 26604
Salt Lake City, UT 84126-0604
800-505-6636, 801-521-0869
E Mail: KEYSOFT@BURGOYNE.COM
Web: www.masterkeypro.com
Rick Wilkinson Pres.
Melanie Wilkinson VP
Product Categories: D G

Keysure

P.O. Box 362
Hudson, NY 12534
800-803-7308, 518-828-5337
E Mail: keysure@taconic.net
Web: www.keysure.net
Len Sideri
Product Categories: F

Killeen Security Products

33 Hermon St.
Worcester, MA 01610
800-577-5397, 508-754-1714
Fax: 508-753-2183
Web: www.iccore.com
Norman Doucet President
Doug Maston Vice President
Product Categories: F
See ad on page 110

Knaack Mfg. Co.

420 E. Terra Cotta Ave.
Crystal Lake, IL 60014
800-456-7865, 815-459-6020
Fax: 815-459-9097
E Mail: info@knaack.com
Web: www.weatherguard.com
Brad Fagala Prom. Mgr.
Rick Bielski Nat'l. Sales Mgr.
Pete Edwards Fleet Sales Mgr.
Product Categories: G

Knight Safe Mfg.

P.O. Box 250
Upland, CA 91785
800-872-2458, 909-982-9653
Fax: 909-982-0529
E Mail: knightsafemfg@aol.com
Web: www.knightsafemfg.com
Leland Scheu President
Product Categories: H

Knox Company

17672 Armstrong
Irvine, CA 92614
800-552-5669, 714-252-8181
Fax: 714-252-0482
E Mail: info@knoxbox.com
Web: www.knoxbox.com
Cindy Schofer
Product Categories: F H

Kouba & Associates Inc.

P.O. Box 1036
Bastrop, TX 78602
877-873-4692, 512-303-5033
Fax: 512-312-4692
E Mail: jacquie@onr.com
Web: www.koubasystems.com

PRODUCT CATEGORY KEY

- A — Alarms
- B — Architectural Hardware
- C — Training Manuals & Materials
- D — Locksmith Software
- E — Electronic Security Products
- F — Locking Products
- G — Locksmith Tools & Equipment
- H — Safes & Safe Products

Derrell Kouba
Jacquie Reeder
Scott Wilson
Product Categories: A E F

Kryptonite Corp.
320 Turnpike St.
Canton, MA 02021
800-SAY-LOCK (729-5625), 617-828-6655
Fax: 617-821-4777
Michael Zane CEP
Stephen Bates Sales Mgr.
Karen Rizzo Mktg. Mgr.
Product Categories: F

Kustom Key Inc.
1010 Aviation Dr.
Lake Havasu City, AZ 86403
800-537-5397, 520-453-8338
Fax: 800-235-4728
E Mail: SALES@KUSTOMKEY.COM
Web: www.kustomkey.com
Dave Vedder Pres.
Michael Vedder GM
Tony Profera Dir. Mktg.
Product Categories: G
See ad on page 29

**Kwikset Corporation - A
Black & Decker Comp.**
One Park Plaza
Irvine, CA 92714
800-327-LOCK, 949-474-8800
Fax: 949-474-879
Web: www.kwikset.com
Dennis Heiner Pres.
Tom Haapala VP Mktg.
Mike Convey VP Sales
Product Categories: F

KXL Manufacturing Corp.
3010 N. River Rd.
River Grove, IL 60171
708-453-1788
Fax: 708-456-9476
Sidney Falk CEO
Martin Alvarez Asst. Mgr.
Barbara Control
Product Categories: A E F

L&S Security Products
13418 Halldale Ave. P.O. Box 1337
Gardena, CA 90249
310-329-2268
Fax: 310-532-4988
E Mail: LSSECPROD@AOL.COM
Web: members.aol.com/lsecprod/index.html
Ms. Angela Mandic US Sales Mgr.
Product Categories: A B E F

La Gard Inc.
3330 Kashiwa St.
Torrance, CA 90505
310-325-5670
Fax: 310-325-5615
E Mail: Susan.Papa@LAGARD.COM
Web: www.LAGARD.COM
Larry Cutter Pres.
Susan Gartner VP Sale & Mktg.
Product Categories: E F H

LAB Security
700 Emmett St.
Bristol, CT 06010
800-243-8242, 860-589-6037
Fax: 860-583-7838
E Mail: labpins@snet.net
Web: www.lab-lockpins.com
Michael Sigmund Dir. International Sales
and Mktg.
Gerald G. Roraback Exec. VP
Crosby J. Kelly VP Sales & Mktg.
Product Categories: F G
See ad on page 170

Ladyfayre Holdings LTD
#527-7620 Elbow Dr.
Calgary AB, Canada T2V 1K2
800-579-0737
403-258-2588
Fax: 403-640-4215
E Mail: ladyfayre@ultralink.com
Maurice Benson
Product Categories: B G

Laperche
334 6th St. SE
Washington, DC 20003
Vicent Mareel

Latch-Gard Co. Inc.
P.O. Box 425 110 South Elkhart
Wakarusa, IN
219-862-2373
Fax: 219-862-2459
Randall Moyer Pres.
David Geiger VP
Product Categories: B F

LCN Closers
Box 100
Princeton, IL 61356
815-875-3311
Fax: 815-875-3222
R.C. Ivey Mktg. Dir.

Lectro Truck/IMS
P.O. Box 700169
Oostburg, WI 53070
800-619-0625, 920-564-6272
Fax: 920-564-2322
E Mail: lectro@excel.net
Web: www.lectrotruck.com
Jason Tagel
Kevin Peters
Bobbie Peters
See ad on page 59

Leisure Innovations
P.O. Box 6098
Los Osos, CA 93412
805-534-1118
Fax: 805-534-0559
Paul Maples

LeRoy Edenburn Enterprises
57 N. Huron St.
Ypsilanti, MI 48197
734-483-2444
Fax: 734-485-8769
LeRoy Edenburn RL CPS
Product Categories: G

Lexxel Lock Mfg.
1274 49th St., Unit 130
Brooklyn, NY 11219
888-972-6626, 718-972-5415
Fax: 718-972-4239
E Mail: lexxellock@aol.com
Frieda Lefkonitz CEO
Sarah S. Sales
Sol Kay Sales Mgr.
Product Categories: A B E F

Liberty Hardware
314 Chimney Rock Rd. #5
Greensboro, NC 27409
910-434-5051
Fax: 910-434-3364
Karen Walls

Liberty Lock & Safe
5470 W. Sahara Ave.
Las Vegas, NV 89146
702-871-5397
Fax: 702-876-5470
E Mail: info@libertylock.com
Web: www.libertylock.com
Joe Esposito

**Liberty Safe & Security
Products Inc.**
1060 Spring Creek Place
Springville, UT
800-247-5625, 801-489-8550
Fax: 801-489-6409
Web: www.libertysafe.com
Jeff Talley President
James Skousen Marketing Director
Product Categories: H

Lifetime Products
P.O. Box 465
Kewanee, IL 61443
800-369-5365, 309-853-3387
Fax: 309-853-3389
E Mail: tamco@inw.net
Web: www.lift-a-load.com
Jim Themanson Prod. Mgr.
Product Categories: H

Lindustries Inc.
21 Shady Hill Rd.
Weston, MA 02493
781-237-8177
Bill & Louise Lind
Product Categories: F G
See ad on page 86

Linear
2055 Corte Del Nogal
Carlsbad, CA 92009
760-438-7000
George Kanelos

Lion Security Products
2611 Ulysses St. NE
Minneapolis, MN 55418
800-477-7657, 612-789-7657
Fax: 612-789-0706
Sal DiLeo Pres.
Beth Kirby Nat'l. Sales Mgr.
Dean Nelson Nat'l. Mktg. Dir.
Product Categories: A E

Lisle Corp.
P.O. Box 89
Clarinda, IA 51632-9978
712-542-5101
Fax: 712-542-6591
Fred Lisle
Product Categories: G

Lloyd Matheson Inc.
P.O. Box L
Charleston, NH 03603
603-826-5777
Fax: 603-826-4186
Evan Matheson

Locinox USA Inc
P.O. Box 5283
Ft. Lauderdale, FL 33310-5283
888-711-0600, 954-714-0600
Fax: 954-749-0639
Hank Stern
Gaspard Fiorine Bus. Mgr.
Product Categories: F

Lock Design Company
PO Box 1387
Concord, MA 01742
508-287-0737
Fax: 508-287-0737
Randy Oxley

PRODUCT CATEGORY KEY

A	—	Alarms
B	—	Architectural Hardware
C	—	Training Manuals & Materials
D	—	Locksmith Software
E	—	Electronic Security Products
F	—	Locking Products
G	—	Locksmith Tools & Equipment
H	—	Safes & Safe Products

Lock Technology Inc.

552 S. Washington Ste. 108
Naperville, IL 60540
800-421-7241, 630-369-6060
Fax: 630-983-5967
George C. Stockin Jr. Pres.
Product Categories: G

Lockbutler, SBD Inc.

3806 Knights Bridge
Rowlett, TX 75088
972-772-3471
Fax: 972-772-0526
E Mail: lockbutler@airmail.net
Web: www.lockbutler.com
Dewayne Irwin
Shawn Fertner
Byron Williams
Product Categories: D

Locknetics Security Engineering

P.O. Box 9337
Forestville, CT 06010
860-584-9158
Fax: 860-584-2136
E Mail: INFO@LOCKNETICS.COM
James Scott Pres.
George R. Nortonen VP Mktg. & Sales
Product Categories: E

Lockplus Software

90 Montreal Rd.
Vanier Ont., Canada
K1L 6E6
613-745-5096
Fax: 613-749-8538
Dan Boulерice

Locksmith Dispatcher 2000

1533 Burgundy Parkway
Streamwood, IL 60107
630-837-2044
Fax: 630-837-1210
E Mail: natlock@aol.com
Web: www.DiamondSoftwareSystems.com
Faron Dunn
Marc Goldberg
Product Categories: D

Locksmith.com

1400 SW First St.
Miami, FL 33135
800-323-8324, 305-649-1207
Fax: 305-541-0074
E Mail: webmaster@locksmith.com
Web: www.locksmith.com
Aurelio "Tony" Vigil
Max Rameau
Miriam Vigil
Product Categories: C D E

Locksoft Inc.

P.O. Box 129
Hastings, NE
402-461-4149
Fax: 402-461-4359
E Mail: ls24242.navix.net
Web: www.locksoft.com
Adam L. Blum President
Billy B. Edward Jr. CML Vice President
Dorothy G. Friend CML General
Manager
Product Categories: D G
See ad on page 85

Lonchar's Inc.

957 W. King Rd.
Malvern, PA 19355-2053
215-546-4422
Fax: 215-546-5979

Nick Lonchar Pres.
Maureen Lonchar VP
Bill McNiff Dir. Sales & Mktg.
Product Categories: E F

Lori Lock

384 Old Turnpike Rd. P.O. Box 1040
Southington, CT 06489
860-621-3605
Fax: 860-621-5972
Web: www.lorilock.com
Andy Meade Pres.
Ken Therianh Ex. V.P.
Product Categories: F

Lucky Line Products Inc.

7890 Dunbrook Rd.
San Diego, CA 92126
800-654-6409, 858-549-6699
Fax: 858-549-0949
E Mail: JPenaskovic@Luckyline.com
Web: www.luckyline.com
Julie Penaskovic Associate Sale Manager
Brent Howard VP Sales & Mktg.
Chandna Thompson, Sales Assistant
Product Categories: G

Lund Key Control Equipment Co.

P.O. Box 213
Bath, OH 44210
330-659-4800
Fax: 330-659-9347
E. Howard Lund Pres.
John Skeel VP
Ray Smiley Sup.
Product Categories: F
See ad on page 94

M. Dufau Co.

921 SW 127th Place
Miami, FL 33184
Manuel Duyfau

M.A.G. Eng. & Mfg. Inc.

15381 Assembly Lane
Huntington Beach, CA 92649
800-624-9942, 714-891-5100
Fax: 714-892-6845
E Mail: mageng@mindspring.com
Web: www.magsecurity.com
Howard M. Allenbaugh Pres.
W. Pat Collins VP Sales
Gary Deter, Nat'l Sales Mgr.
Product Categories: B F

M.K. Morse Company

P.O. Box 8677
Canton, OH 44711
800-733-3377, 330-453-8187
Fax: 800-729-1112, 330-453-1111
E Mail: MKMORSE@MKMORSE.COM
Web: www.MKMORSE.COM
James Batchelder Pres.
Kim Reynolds Nat'l Sales Mgr.
Product Categories: G

MacLock Industries

301 Pico De La Loma
Escondido, CA 92089
Mark Bently

Magi-Corp Inc.

P.O. Box 627
Vernon, CT 06066
860-872-4222
Fax: 860-872-4600
Roger Coulombe

Magnokrom Inc.

3965 Nashua Drive
Mississauga Ontario, Canada
L4V 1P3
905-671-2525
Fax: 905-671-2888

E Mail: info@magnokrom.com
Web: www.magnokrom.com
Edward Milic Pres.
B. Johnson Purchasing
Product Categories: B F
See ad on page 13

Majestic Lock

194 Daniel St.
Hackensack, NJ 07601
201-343-7315
Stephanie MacFarlane
Alan Litroff

Major Manufacturing Inc.

1825 Via Burton
Anaheim, CA 92806
714-772-5202
Fax: 714-772-2302
E Mail: mail@majormfg.com
Web: www.majormfg.com
Bill DeForrest
John King
Product Categories: F G
See ad on page 79

Major Metalfab Inc. (MMF)

370 Alice St.
Wheeling, IL
800-445-8293, 847-537-7890
Fax: 847-537-1120
E Mail: mmmfind@wwa.com
Web: www.mmmfind.com
Val Burlini Pres.
Rob Fosness VP Sales
Peter Lindley Dir. Sales
Product Categories: B F G

Markar Products Inc.

68 Ward Rd.
Lancaster, NY 14086
800-866-1688, 716-685-4104
Fax: 716-685-3919
E Mail: CUSTSUPP@MARKAR.COM
Web: www.markar.com
Stan Tataro AHC-CEO
Tom Frys VP
Kevin Hamilton Pres.
Product Categories: B C

MARKS U.S.A.

5300 New Horizons Blvd.
Amityville, NY 11701
800-526-0233, 631-225-5400
Fax: 631-225-6136
E Mail: wjs@marksusa.com
Web: www.marksusa.com
George Marks Pres.
William Sporre, Nat'l Sales Mgr
Product Categories: B E F

Marlee Electronics

1530 Old Oakland Rd., #100
San Jose, CA 95112-1241
800-260-5265, 408-451-2520
Fax: 408-441-0309
E Mail: sales@kerisys.com
Web: www.kerisys.com
Chuck Fontana
Chas Tevis
Product Categories: E

Murray Enterprises Inc

1128 Walsh Ave
Santa Clara, CA 95050
800-500-1449, 408-970-0213
Fax: 408-970-8767
E Mail: ray@murray.com
Web: www.murray.com
Ray Zehrung
Product Categories: E G B F
See ad on page 87

Master Lock Company

2600 North 32nd Street
 Milwaukee, WI 53210
 414-444-2800
 Fax: 414-444-0322
 John Heppner VP Sales
 Dave Love VP Marketing
Product Categories: B F

Maxim Technologies Inc.

P.O. Box 275
 New Gardens, NY
 718-847-1352
 Fax: 718-805-4438
 J.K. Lapham
 Timothy Ryan VP
 Joan Moriarty Office Mgr.
Product Categories: B F

Maxis Security Locks

120-B-3773 Still Creek Ave.
 Burnaby BC, Canada V5C 4E2
 604-434-5625
 Fax: 604-434-5695
 E Mail: MAXIS@DIRECT.CA
 Mike Wong
Product Categories: F

Maxton Security Systems

5961 Topeka Dr.
 Tarzana, CA 91356
 818-776-8557
 Fax: 818-776-8558
 E Mail: maxtonlocks@webtv.net
 Anthony B. Bennett Pres.
Product Categories: F

MBI Business Software

5249 Galaxy Parkway
 Sacramento, CA
 800-551-4624, 916-444-2922
 Fax: 916-393-0930
 E Mail: sales@mbisoftware.com
 Web: www.mbisoftware.com/locksmith.HTM
 Danna A. Munley Pres.
 Done' J. Biasi VP Devel.
Product Categories: D

McDowell-Craig

13146 Firestone Blvd.
 Norwalk, CA 90650
 562-921-4441
 Fax: 562-921-9648
 Steven Craig
Product Categories: F

**McGunn Safe Co.
 L.L.C.**

3838 W. 51st Street
 Chicago, IL 60632
 800-621-2816, 773-884-3560
 Fax: 773-884-6560
 E Mail: alanh@mcgunnsafe.com
 Web: www.mcgunnsafe.com
 Alan Hepker, C.E.O
 Pat McGunn, President
Product Categories: E H

**MDS (Medical Diagnostics
 Services Inc.)**

511 N. Limona Rd.
 Brandon, FL 33510
 800-435-9352, 813-653-1180
 Fax: 813-684-5953
 E Mail: mdsinc@gte.com
 Web: www.medsincorporated.com
 Paul Butler Pres.
 Trudi R. Battle VP
 Bob Battle, Sales Manager
Product Categories: G

Medeco Security Locks Inc.

P.O. Box 3075

Salem, VA 24153
 800-839-3157, 540-380-5000
 Fax: 540-380-5010
 Web: www.medeco.com
 Joey Dalessio
 Len Blackwell
 Brian Schofner
Product Categories: C E F

Megan Marie Creations

200 Covington Drive
 Bloomingdale, IL 60108
 800-4-KEYKIT, 630-529-2900
 Fax: 630-529-4395
 E Mail: keykit@aol.com
 Rich Paetz

Meilink Safe Co.

101 Security Parkway
 New Albany, IN 47150
 800-634-5465, 812-941-0024
 Fax: 800-896-6606
 E Mail: meilink@meilinksafes.com
 Web: www.meilinksafe.com
 Van Carlisle Pres. & CEO
 Judd Penske Nat'l. Sales Mgr.
 Lloyd Jones VP Sales
Product Categories: H

Meister Atlanta Corp.

3673 Clairmont Rd.
 Atlanta, GA 30341
 404-451-9700
 Fax: 404-451-5305
 Renate Detlefs
Product Categories: F

Metragen Co. Ltd.

3701 Chesswood Dr #309
 North York ON, Canada M3J 2P6
 416-635-9212

**Milman Casting
 Manufacturing**

PO Box 914
 Lewison, NY 14092
 905-632-4473
 Fax: 905-632-4534
 Ed Burgess

Mitchell International

9889 Willow Creek Rd.
 San Diego, CA 92131
 858-578-6550

**Miwa Lock Canada/ Aline
 Distributors**

Station 'D'
 Edmonton AB, Canada T5L 4J7
 888-451-6545
 Fax: 780-452-7551
 Gary J. Mozak Sales Mgr.
Product Categories: B F

Miwa Lock USA

P.O. Box 98214
 Las Vegas, NV 89193
 800-397-4631, 702-454-9888
 Fax: 702-454-4577
 E Mail: miwalockusa@aol.com
 Web: www.miwalockusa.com
 Will Schaff Pres.
Product Categories: B F

PRODUCT CATEGORY KEY

- A — Alarms
- B — Architectural Hardware
- C — Training Manuals & Materials
- D — Locksmith Software
- E — Electronic Security Products
- F — Locking Products
- G — Locksmith Tools & Equipment
- H — Safes & Safe Products

**The
 National
 Locksmith
 Magazine
 Subscription**



This is THE source for automotive technology, safe opening techniques, electronic security and much, much more.

CLICK HERE TO LEARN MORE



#SUB - 1,2,3,4,5,6

MANUFACTURERS

Monarch Hardware & Mfg. Co.

P.O. Box 548
Shepherdsville, KY 40165
800-826-5792, 502-543-2281
Fax: 800-924-3551
E Mail: monarch@ingerrand.com
Web: www.monarchhardware.com
Michael Epperson GM Sales Manager
Robert C. Johnson AHC GM
Robert McGehee Cust. Svc. Mgr.
Product Categories: B E

Monarch Tool and Mfg. Co. Inc.

105 East Fourth St.
Covington, KY 41011
800-462-9460, 859-261-4421
Fax: 859-261-7403
E Mail: sales@monarchcoin.com
Web: www.monarchcoin.com
Stephanie Hall Pres.
Pete Bigner, VP
Norman Martin Corp. Admin.
Product Categories: F
See ad on page 113

Monitek Research Labs

7640 Fullerton Rd.
Springfield, VA 22153
800-989-9891, 703-569-0195
Fax: 703-569-0196
George Zachmann
Product Categories: E F

Morning Industries

19721 E. Country Hollow Dr
Walnut, CA 91789
909-869-0552
Fax: 909-869-5663
E Mail: morningindustries@yahoo.com
Web: www.morningindustries.com
Jeff Chen
Product Categories: B E F

Morse Watchmans Inc.

2 Morse Rd.
Oxford, CT 06478
800-423-8256, 203-264-4949
Fax: 203-264-8367
Manuel Pires Pres.
Fernando Pires VP
Product Categories: E

Mosler Inc.

8509 Berk Blvd
Hamilton, OH 45015
800-MOSLER-1, 513-870-1900
Fax: 513-870-1175
Web: www.mosler.com
John Pearce Dir. Mktg. Comm
Product Categories: A E F H

Mr. Chime Inc.

915 Calle Amanecer, Ste. O
San Clemente, CA 92673
877-MRCHIME
949-366-9435
Fax: 949-366-9436
E Mail: info@mrchime.com
Web: www.mrchime.com
Mike A. Sansky Pres.
Product Categories: A E

Multi Lock Inc.

P.O. Box 70277
Ft. Lauderdale, FL
800-879-5645, 954-563-2148
Fax: 954-563-5644
E Mail: jford@multilock.com
Web: www.multilock.com
Jerold Ford Pres.
M.E. De Palma VP.
Clarence Fulton Plt. Mgr.
Product Categories: F

Multi-Lock Corporation

1500 West Seltice Way
Post Falls, ID 83854
800-474-2220, 208-777-6543
Fax: 208-777-6402
E Mail: contact@security-multilock.com
Web: www.security-multilock.com
Brian Kleinjans Dir. Mktg. Sales Oper.
Product Categories: F

Mul-T-Lock USA Inc.

300-1 Route 17 South, Suite A
Lodi, NJ 07644
800-562-3511, 973-778-3222
Fax: 973-778-4007
E Mail: MTLUSA@AOL.COM
Web: www.Mul-T-Lock.com
Zvi Yaniv CEO
Rami Almosnino Technical Manager
Michael Pennachio Marketing Manager
Product Categories: B F

Mutual Safe Company

937 Newhall St
Costa Mesa, CA 92627
800-443-0731, 949-645-0731
Fax: 949-645-8119
E Mail: rgreen2mutualsafes.com
Web: www.mutualsafes.com
Rowan Green

Mytek America

8334 Foothill Blvd.
Sunland, CA 91040
800-228-0896, 818-352-4994
Fax: 818-352-9794
E Mail: MYTEK@IX.NETCOM.COM
Tim Choi
Product Categories: A E

Nanotechnology Inc.

22997 Standing Oak Ct.
Cupertino, CA
408-973-8280
Fax: 408-973-8280
John Chu Pres.
Ann Woo VP Mktg.
Product Categories: E

National Door Controls

P.O. Box 2502
Durham, NC 27715
800-231-0402
Fax: 919-220-6084
Robert Hales

National Locksmith, The

1533 Burgundy Parkway
Streamwood, IL 60107
630-837-2044
Fax: 630-837-1210
E Mail: natllock@aol.com
Web: www.TheNationalLocksmith.com
Marc Goldberg Publisher
Product Categories: C D

National Mfg. Co.

P.O. Box 577
Sterling, IL
815-625-1320
Fax: 815-625-1333
Matthew L. Minnick

National Security Safe Co.

620 South and 380 East
America, UT 84003
800-544-3829, 801-756-7706
Fax: 801-756-8043
Glen Nilson Pres.
Dave Farmer VP

Steve Frandsen Asst. VP

Product Categories: H

Nationwide Lock Service

377 Maplewood LN
Crystal Lake, IL 60014
815-477-7707
James Anderson

NEBS Inc.

500 Main St.
Groton, MA 01471
800-367-6327 Ext. 94444, 508-448-6111
Fax: 508-448-2827
Web: www.nebs.com
Peggy Straitiff

NEL-TECH

2515 E. Michigan Blvd.
Michigan City, IN 46360
800-874-2050, 219-874-7500
Fax: 219-874-9990
James Alinsky GM
Product Categories: E

New England Lock & Hardware Co.

P.O. Box 544
S. Norwalk, CT 06854
203-866-9283
Fax: 203-838-4837
James W. Egan President
John J. Egan VP Sales
Product Categories: F

New Standard Mfg. Co.

7005 Speedway Blvd., Bldg. F111
Las Vegas, NV 89115
702-649-0599
Fax: 702-649-0544
E Mail: newstandardmfg@mindspring.com
Randy L. Thwing
Kathalynn F. Thwing
Product Categories: F

Next Generation Tool Co.

2447 N. Wickham Rd. Suite 138
Melbourne, FL 32935
800-874-LOCK (5625), 915-698-3094
Fax: 915-698-7622
E Mail: nxtgentool@aol.com
Web: www.nextgentool.com
Darrell Bolton
Joanie Bolton
Product Categories: G

NKL Industries

1111 Cavalier Blvd.
Chesapeake, VA 23323
800-528-9900, 757-485-0200
Fax: 757-485-0271
Mike Smith Pres.
Vic Yurkobic Tech. Supp.
Ray Lorenzo CEO
Product Categories: E H

Noble Security Systems Inc.

P.O. Box 18977
Encino, CA 91416-8977
818-881-0354
Fax: 818-881-9404
Gady Avganian

PRODUCT CATEGORY KEY

A	—	Alarms
B	—	Architectural Hardware
C	—	Training Manuals & Materials
D	—	Locksmith Software
E	—	Electronic Security Products
F	—	Locking Products
G	—	Locksmith Tools & Equipment
H	—	Safes & Safe Products

Numberall Stamp & Tool Co. Inc.

P.O. Box 187 High St.
Sangerville, ME 04479
207-876-3541
Fax: 207-876-3566
E Mail: www.office@numberall.com
Web: www.numberall.com
Rick Pellerin Sales Mgr.
Product Categories: G

NU-SET LOCK

1219 John Reed Ct.
City of Industry, CA 91745
800-606-8738, 626-937-3080
Fax: 626-937-3083
E Mail: loyal@nuset.com
Web: www.nuset.com
Carol NG
Product Categories: F

OEM Mfg. Inc.

194 Daniel St.
Hackensack, NJ 07601
800-243-8636, 201-489-2184
Fax: 201-343-7315
Wes Zion Pres.
StephanFie McFarlane VP
Jeff Zion
Product Categories: F G

Olympus Lock Inc.

2720 NE 115th St.
Seattle, WA 98125
800-525-0954, 206-362-3290
Fax: 206-362-3569
E Mail: INFO@OLYMPUS-LOCK.COM
Web: www.olympus-lock.com
Frank J. Martin CEO
Jerry Martin Pres.
James Negri, General Sales Manager
Product Categories: F

Omnia Industries Inc.

P.O. Box 330
Cedar Grove, NJ 07009
973-239-7272
Fax: 800-542-7611
Alberto R. Comini Pres.
Denyse Comini Becker Exec. VP
John L. Barwick Vice President
Product Categories: B F

Optex (U.S.A.) Inc.

1845 W. 205th Street
Torrance, CA 90501
800-966-7839, 310-533-1500
Fax: 310-533-5910
Dennis Olson Pres.
Rob Blair Dir. HBA Div.
Ned Morioka Nat'l. Sales Mgr.
Product Categories: E

Ortega Supply

PO Box 390647 Dept. 4
Anza, CA 92539
909-763-9667
Fax: 909-763-9755
Dave Speer

OSI Security Devices

1580 Jayken Way
Chula Vista, CA 91911
619-628-1000
Fax: 619-628-1001
E Mail: sales@omnilock.com
Web: www.omnilock.com
Rick Rasmussen
John Holm
Mary Kirk
Product Categories: E
See ad on page 91

P.E. Fraser Inc.

830 Godin
Vanier Quebec, Canada G1M 2X9

32 • The National Locksmith

418-681-3214
Fax: 418-681-3352
E Mail: FRASER@MEDIOM.QC.CA
Web: www.mediom.qc.ca/~fraser
Michael Dravigne
Product Categories: F H

Pacel Corp.

8870 Rixlew Lane
Manassas, VA 20109-3794
703-257-4759
Fax: 703-361-6706
E Mail: locksmith@pacel.com
Web: www.pacel.com
Dave Calkins
Product Categories: D

Pach & Company

941 Calle Negocio
San Clemente, CA 92672
714-498-2951 Fax: 714-498-6879
John Camp Nat'l. Sales Mgr.
Product Categories: E

Pacific Scientific Motor Products Div.

4301 Kishwaukee St.
Rockford, IL 61109
815-226-3100
Fax: 815-226-3148
Ronald Nelson Pres.

Pacific Security Products Co.

1641 W. Main Street # 211
Alhambra, CA 91801
800-331-0785, 626-570-4655
Fax: 626-289-2326
Jae Chang Owner
Product Categories: H
See ad on page 156

Padlocks 4 less

P.O. Box 75449
Seattle, WA 98125
206-972-4557
Fax: 206-523-9876
E Mail: timf@padlocks4less.com
Web: www.padlocks4less.com
Tim Freeman

Pado Security Inc.

P.O. Box 13744
New Orleans, LA 70185-3744
800-523-9877, 504-482-5318
Fax: 504F-486-6509
E Mail: PADO007@AOL.COM
William Winterfeld Pres.
James B. George Oper. Mgr.
Product Categories: F G

Paktek Inc.

7307 82nd St. Ct. SW
Tacoma, WA 98498
800-258-8458, 253-584-4914
Fax: 253-589-1091
E Mail: paktek@prodigy.com
Web: www.toolpak.com
Mark Blanchard Pres.
Alan Billingsley CEO
Steve Tucker Sales
Product Categories: G

Palmer Security Products Inc.

2930 N. Campbell Ave.
Chicago, IL 60618
800-788-7725, 773-267-4855
Fax: 773-267-8080
E Mail: info@palmersecurity.com
Web: www.palmersecurity.com
Chuck Whisler David Burton
Product Categories: H
See ad on page 146

Panef Corp.

5700 W. Douglas Ave.

Milwaukee, WI 53218
800-448-1247, 414-464-7200
Fax: 414-462-0980
Linda J. Hartley
George Walker Chairman
Product Categories: G

Papaiz U.S.A. Ltd.

1075 W. Sam Houston Pky N. #208
Houston, TX
800-467-7195, 713-467-7196
Fax: 713-467-7198
E Mail: PAPAIZUSA@AOL.COM
Web: www.papaizlocks.com
Marcel DeSouza
Cindy Wilson
Product Categories: F

Patio Intel-X Inc.

130 St-Jean
Drummondville Que., Canada J2B 5K8
819-477-9047
Fax: 819-477-0000
Peter Dezil

PC Guardian (Computer Security Products)

1133 East Francisco Blvd.
San Rafael, CA 94901
800-288-8126, 415-459-0190
Fax: 415-459-1162
E Mail: pcg@pcguardian.com
Web: www.pcguardian.com
Diane Balmer-Martin Marketing Manager
Product Categories: F

PCSC

3541 Challenger St.
Torrance, CA 90503
310-638-0400
Fax: 310-638-6204
E Mail: SALES@1PCSC.COM
Web: www.1PCSC.COM
Bob McKee
Product Categories: E A

PDQ Industries

P.O. Box 507
Leola, PA 17540
800-441-9692, 717-656-4281
Fax: 717-656-6892
E Mail: PDQ@PPTNET.COM
Web: www.pptnet.com/pdq
Bill Tell Pres.
Product Categories: B F
See ad on page 140

PEMCO Mfg. Co.

P.O. Box 3780
Ventura, CA 93006-3780
800-283-9988, 805-642-2600
Fax: 805-642-4109
E Mail: SALES@PEMCO.COM
Web: www.pemco.com
Charlie Kops VP Sales
Mike Eckles National Sales Mgr
Mark Page Commercial Prod. Mgr.
Product Categories: B F

Period Brass

P.O. Box 520
Jamestown, NY 14701
800-332-6677 Fax: 800-215-8837
Roby T. Briggs VP Sales & Mktg.
Mark Kamppinen Mktg. Mgr.
Product Categories: B

Perma Vault Safe Corp.

P.O. Box 473
Huntingdon Valley, PA 19006
800-662-3360, 215-938-4300
Fax: 215-938-4310
E Mail: SALES@PERMA-VAULT.COM
Web: www.PERMA-VAULT.COM

Marvin Sobel Pres.
 Irv Plaksen Co-founder
 Ronald Johnson Gen. Mgr.
Product Categories: H
See ad on page 147

Personal Safety Corp.

1905 N. Center Point Rd./ P.O. Box 128
 Hiawatha, IA 52233
 319-378-8787
 Fax: 319-378-1311
 Thomas R. Leidigh Pres.

Peterson Manufacturing

P.O. Box 744
 Est Rochester, NY 14445
 716-264-1199
 Fax: 716-586-0425
 Ken Persson
Product Categories: G

Phoenix Industries Inc.

P.O. Box 38
 Linwood, KS 66052
 800-238-3203, 913-723-3203
 Fax: 913-723-3507
 E Mail: sharonc@unicom.net
 Web: www.ndiyp.com
 Jeff Coatney
 Sharon A. Coatney Sec. Treas.
Product Categories: A B E F

Power Access Corporation

P.O. Box 235
 Collinsville, CT 06022
 800-344-0088, 203-693-0751
 Fax: 203-693-0641
 E Mail: POWACCESS@AOL.COM
 Nils Sellman Pres.
Product Categories: E F

PowerStar Products Inc.

1050 East Duane Ave.

Sunnyvale, CA 94086
 408-774-6800
 Fax: 408-774-6818
 D. Scott McFadin President
 Brian Marisolf Sales Manager
Product Categories: G

PPM 2000 Inc.

10405 Jasper Ave., Suite 1400
 Edmonton AB, Canada T5J 3N4
 888-776-9776, 403-448-0616
 Fax: 403-448-0618
 E Mail: info@ppm2000.com
 Web: www.ppm2000.com
 Elaine O'Sullivan VP Mktg.
 Joe Lemmon, Product Manager
 Elizabeth Beth, Sales Coordinator
Product Categories: D

Precision Hardware

PO Box 40
 Romulus, MI 48174-0040
 734-326-7500
 Fax: 734-326-7540
 Scott McIntire
Product Categories: B E F

Preso-Matic Keyless Locks

100-A Commerce Way
 Sanford, FL 32771
 800-269-4234, 407-324-9933
 Fax: 407-328-9977
 E Mail: campbell@parkave.net
 Bob Campbell VP Sales
 Grant Campbell VP
 Doug Van Dee Prod. Mgr.
Product Categories: F

Prestolock by CCL Security Products

199 Whiting St.

New Britain, CT
 800-216-0082, 203-229-6199
 Fax: 203-223-7601
 E Mail: PRESTOLOX@AOL.COM
 Tom Melkus Mng. Dir.
Product Categories: F

Prime-Line Products Co.

5405 Industrial Parkway
 San Bernadino, CA 92407
 800-255-3505, 909-887-8118
 Fax: 909-880-8968
 E Mail: JFRI@PLP.mhs.compuserve.com
 Jim Friesen Sales Mgr. Locksmith Div
Product Categories: B F

Programmed Marketing

121 Hamilton Ave
 Stamford, CT 06902
 203-353-1200
 Fax: 203-348-3473
 Ted Grejtak

Progressive Hardware Co. Inc

63 Brightside Ave
 East Northport, NY 11731
 516-757-8866
 Fax: 516-757-8870
 William Zilz

PRODUCT CATEGORY KEY

- A — Alarms
- B — Architectural Hardware
- C — Training Manuals & Materials
- D — Locksmith Software
- E — Electronic Security Products
- F — Locking Products
- G — Locksmith Tools & Equipment
- H — Safes & Safe Products

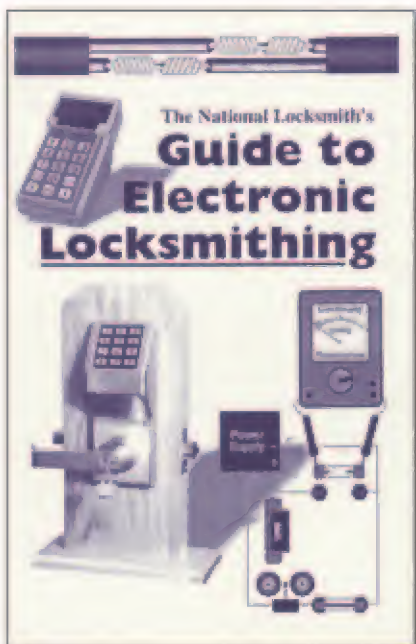

Electronic Locksmithing

Everyone knows there's big money in selling, installing and servicing electronic security such as mag locks, electronic strikes, and simple access control.

CLICK HERE TO LEARN MORE



#EL - 1

PRO-LOK

655 N. Hariton St.
 Orange, CA 92868
 714-633-0681
 Fax: 714-633-0470
 E Mail: mail@pro-lok.com
 Web: www.pro-lok.com
 Adam Weinraub Pres.
 Lori Weinraub Sales Customer Service
 Marshall Daugherty Sales C-S
Product Categories: C G H F
See ad on page 9

Protection Technologies Inc.

185 N. Edison Way #1
 Reno, NV 89502
 702-856-7333
 Fax: 702-856-7658
 Larry Thomas

Quality Products & Services

2128 S. Grove Ave. #F
 Ontario, CA 91761
 909-947-9900
 Fax: 909-947-4260
 Eric Alber

Quintana Inc.

P.O. Box 813., FDR Station
 New York, NY 10150
 Richard Quintana

R.J. Stuckel Co. Inc.

1385 Howard St.
 Elk Grove, IL 60007
 800-789-7220, 847-593-7220
 Fax: 847-593-6027
 Robert W. Stuckel Pres.
Product Categories: G

R.R. Brink Locking Systems Inc.

500 Earl Rd.
 Shorewood, IL 6043
 815-744-7000
 Fax: 815-744-7020
 E Mail: rbrink@rrbrink.com
 Robert R. Brink
 Charles R. Brink
 Stephen J. Fox Cust. Svc. Mgr.
Product Categories: B E

Rainbow Doors

3 Nami Ln.
 Hamilton, NJ 08619
 800-892-1701
 Fax: 800-889-4938
 Frank Nattoli

Rankin Security

525 Bolt Lane
 Hemet, CA 92545
 909-927-7007
 Mark Rankin

RB Enterprises

42654 Deep Forest Dr.
 Coarsegold, CA 93614
 800-452-5276, 209-642-2710
 Fax: 209-642-2699
 Robert Barr Owner
Product Categories: A

RCI (Rutherford Controls International Corp.)

2697 International Pkwy. Bldg. 5-100
 Virginia Beach, VA 23452
 800-899-5625, 757-427-1230
 Fax: 757-427-9549
 E Mail: sales@rutherfordUSA.com
 Web: www.rutherfordcontrols.com
 Tracey L. Rutherford VP Operations
 David G. Halls VP Sales & Mkt.
Product Categories: E F

Reading Body Works

P.O. Box 650
 Reading, PA 19607
 800-458-2226, 610-775-3301
 Fax: 610-775-3261
 E Mail: marketng@readingbody.com
 Web: www.readingbody.com
 Jack O'Donnell VP Sales
Product Categories: G

Reading Industries

425 North Third St.
 Reading, PA
 888-428-4593, 610-374-0776 x 3054
 Fax: 610-374-9088
 Norm Mendl
 Jim Wagner
Product Categories: B F H

Reliable Lock

10 Bent Birch Place
 Parsippany, NJ 07054
 201-674-7667
 Joe Panucci

Reth USA Inc.

20257 Paseo Del Prado
 Walnut, CA 91789-2713
 909-468-5666
 Fax: 909-468-5670
 Henry Chu

Rixson-Firemark Sub. of Yale Sec. Inc.

9100 W. Belmont Ave.
 Franklin Park, IL 60131
 708-671-5670
 Robert C. Johnson Gen Sales Mgr.

Rodann Electronics Mfg. Co.

3045 S. Harbor Blvd.
 Santa Anna, CA 92704
 714-662-3232
 Fax: 714-662-3171
 Alex Skarbek Pres.

ROFU International Corp.

2004B 48th Ave. Ct. E
 Tacoma, WA 98424
 800-255-ROFU, 253-922-1828
 Fax: 253-922-1728
 E Mail: julie.rofu@prodogy.net
 Web: www.rofu.com
 Len Guyt Pres.
 Julie Collins Dir. Of Sales and Operations
 Kenneth Erickson VP
Product Categories: B E

Roto Zip Tool Corp.

1861 Ludden Dr.
 Cross Plains, WI 53528
 800-521-1817, 608-798-3737
 Fax: 608-798-3739
 Web: www.rotozip.com
 Michael Clancy
Product Categories: G

RQ Associates

8093 Berkshire
 Grosse Ile, MI 48138
 734-671-2359
 Fax: 734-671-2359
 E Mail: quinn@ili.net
 Richard Quinn
Product Categories: G H

RSR Management Corp.

P.O. Box 4300
 Winter Park, FL 32793
 Sonya Dukes

Rudolph-Desco Company Inc.

580 Sylvan Ave.
 Englewood Cliffs, NJ 07632
 201-568-4920
 Fax: 201-568-0971
 Michael Simond
 Hans Baumann
 Alicia Leon
Product Categories: B

Ryobi America Corp.

P.O. Box 1207
 Anderson, SC 29622
 800-525-2579
 Nancy Bronson

Rytan Inc.

455 Maple Ave.
 Torrance, CA 90503
 800-447-9826, 310-328-6553
 Fax: 310-212-6002
 E Mail: runplastic@aol.com
 Web: www.rytan.com
 Mike Sopko Pres.
 Maritza Fernandez Cust. Svc.
Product Categories: G

S. Parker Hardware Mfg. Corp.

Parker Dr. P.O. Box 9882
 Englewood, NJ 07631
 800-S-PARKER, 201-569-1600
 Fax: 201-569-1082
 E Mail: HARDWARE@SPARKER.COM
 Web: www.Sparker.com
 Chas. Silberman Pres.
 Bob Schaeffer Senior VP
 Toby Bernstein Exec.VP
Product Categories: B F

Saf T Lok

18245 SE Federal Hwy.
 Tequesta, FL 33469
 800-723-8565, 561-743-5625
 Fax: 561-745-6601
 Web: www.saf-t-lok.com
 Bill Schmidt VP of Operations
 John Gardner President
Product Categories: F

Safe & Secure

10736 Jefferson Blvd #774
 Culver City, CA 90230
 310-838-5041
 Merle Dautrey

Safe-O-Mat Deposit Locks

7101 York Ave. S. #226
 Minneapolis, MN 55435
 612-921-3315
 Fax: 800-733-7139
 E Mail: safeomat@yorktownoffices.com
 Web: www.safeomat.com
 Steve Rodesch Sales Mgr.,
Product Categories: F

Safer Image, The

P.O. Box 14444
 Columbus, OH 43214
 614-447-0000
 Fax: 614-421-0008
 Tim Finley

PRODUCT CATEGORY KEY

- A — Alarms
- B — Architectural Hardware
- C — Training Manuals & Materials
- D — Locksmith Software
- E — Electronic Security Products
- F — Locking Products
- G — Locksmith Tools & Equipment
- H — Safes & Safe Products

Safety Technology International Inc.

2306 Airport Rd.
Waterford, MI 48327
800-888-4784, 248-673-9898
Fax: 248-673-1246
E Mail: INFO@STI-USA.COM
Web: www.sti-usa.com
Margie Gobler Pres.
John Taylor VP of R&D
Michael Mikaelian Nat'l. Sales Mgr.
Product Categories: A E
See ad on page 99

SAFLOK

1020 W. 17th St.
Costa Mesa, CA 92627
800-LOCKS-33 OR 562-5733, 714-722-5400
Fax: 714-722-0129
E Mail: PHIL@CSSMAIN.COM
Web: www.winfieldlock.com
Phil Wilder
Barbara Brown
Product Categories: B E F H



Salsbury Industries

1010 E. 62nd St.
Los Angeles, CA
800-323-3003
323-846-6700
Fax: 323-846-6800
E Mail: mailboxes@salsbury.com
Web: salsbury.com
Dennis Fraher
Brian Fraher Dir. Mktg.
Product Categories: F

Sandstrom Products Co.

P.O. Box 547
Port Byron, IL 61275
800-747-1084, 309-523-2121
Fax: 309-523-3912
Web: www.sandstromproducts.com
Rick J. Hartsock Pres.
Brian Suhl Sales Mgr.
Product Categories: F

Sargent & Greenleaf Inc.

P.O. Box 930
Nicholasville, KY 40340
800-826-7652, 859-885-9411
Fax: 859-887-2057
E Mail: custsvc@sglocks.com
Web: sglocks.com
Jerry Morgan President
Tom Leppert Sr. VP Mktg./Sales
Product Categories: E F B
See ad on page 7

Sargent Manufacturing Co.

100 Sargent Drive
New Haven, CT 06511
800-727-5477, 203-562-2151
Fax: 888-863-5054
E Mail: webmaster@sargentlock.com
Web: www.sargentlock.com
Thanasis Molokotos President
Leslie Saunders Manager Partner Relations
Tom Mayer, Manager Aftermarket Accounts
Product Categories: B E F

Schlage Commerical Lock Division

1915 Jamboree Dr.
Colorado Springs, CO 80920
800-847-1864, 719-264-5300

Fax: 719-264-5382
Web: www.schlage.com
Chuck Havill
Jim McElroy
Will Ott
Product Categories: B E G

Schwab Corp.

P.O. Box 5088
Lafayette, IN 47903
800-428-7678, 765-447-9470
Fax: 765-447-8278
E Mail: schwab@schwabcorp.com
Web: www.schwabcorp.com
Jeff McQueen VP Sales & Mktg.
Product Categories: H

Schwenk Lock

60 N. Winchester Blvd
Santa Clara, CA 95050
408-978-0403
Fax: 408-247-5397
E Mail: schwenkco@col.com
Web: www.schwenkco.com
Gene Fridman
Product Categories: G



SECO-LARM USA INC.

17811 Sky Park Circle, Ste. E
Irvine, CA 92614
800-662-0800, 949-261-2999
Fax: 949-261-7326
E Mail: info@seco-larm.com
Web: www.seco-larm.com
S.M Hwang Pres.
Michael J. Block VP
Product Categories: A E F

Secura Key

20447 Nordhoff St.
Chatsworth, CA 91311
800-891-0020, 818-882-0020
Fax: 818-882-7052
E Mail: MAIL@SECUKEY.COM
Web: www.securakey.com
Gordon S. Morris Dir. Sales & Mktg.
Eric Bernocco Nat'l. Sales mgr.
Product Categories: E

SecureRite.com

4775 Viewridge Ave.
San Diego, CA 92123
800-241-3930
Fax: 858-974-5269
E Mail: beth.byrd@securerite.com
Web: www.securerite.com

Securex Americas Div. Of Incas Safe Corp.

665 Millway, Unit 52
Concord ON, Canada L4K 3T8
800-813-8462, 905-660-3025
Fax: 905-660-8823
E Mail: barry@inkas.ca
Web: www.inkas.com
Barry Felsher
Product Categories: H

Securibar

7884 A Thelma
Quebec, Canada G2E 5E2 H8P 1X1
514-984-6997
Fax: 514-366-3095
Daniel Parent

Securitech Group Inc.

54-45 44th St.
Maspeth, NY 11378
800-625-LOCK, 718-392-9000
Fax: 718-392-8944
E Mail: SECURITEC @ AOL. COM
Web: www.securitech.com
Mark Berger Pres.

Christine Spooner Cust. Svc. Mgr.
Product Categories: A B C E F

Securitron Magnalock Corp.

550 Vista Blvd.
Sparks, NV 89434
800-MAG-LOCK, 775-355-5625
Fax: 775-355-5636
E Mail: INFO@SECURITRON.COM
Web: www.securitron.com
Bob Cook Pres.
Vince Frallicciardi VP Mktg.
Scott Baker Sales Director
Product Categories: E F
See ad on page 107

Security Distributors Inc.

8901 Chancellor, Row
Dallas, TX 75247
214-879-15555
Fax: 214-879-1525
Web: www.uscanlock.com
Howard Johnsen Pres.
Paul Justen Vice Pres.
Ron Snycher Vice Pres.
Product Categories: B D E F G H
See ad on page 152

Security Door Controls

P.O. Box 6219 3580 Willow Lane
Westlake Village, CA 91361
805-494-0622
Fax: 805-494-8680
E Mail: service@sdsecurity.com
Web: www.sdsecurity.com
Rick Geringer VP
Arthur Geringer AHC Pres.
Shane Geringer Natl. Sales Mg
Product Categories: E F

Security Fastener Co.

3854 Industrial Way
Benicia, CA 94510
707-746-8025 Fax: 707-746-0347
Rich Ross
R.L. Ross Mktg.
Product Categories: G

Security Innovations Inc.

3541 Challenger St
Torrance, CA 90503-1641
310-638-0400
Fax: 310-638-6204
Robert Takahashi

Security Latch

P O Box 129
Cedarville, MI 49719
800-633-6622, 906-484-3120
Fax: 906-484-2761
E Mail: seclat@sault.com
Web: www.securitylatch.com
Robert Vanderboegh Pres.
Product Categories: B F
See ad on page 23

Security Lock Co.

1155 Chess Drive, Unit 114
Foster City, CA 94404
503-266-9763
Fax: 503-266-2155
Clyde Booth

Se-Kure Controls Inc.

3714 Runge Rd.
Franklin Park, IL 60131
800-322-2435, 847-288-1111
Fax: 847-288-9999
E Mail: SEKURE@MSN.COM
Web: www.se-kure.com
Roger Leyden Pres.
Peter Passuntino VP Oper.

John Mangiameli Nat'l. Sales Mgr.
Product Categories: E

Select Products Limited

9770 Shaver Road
 Portage, MI 49024
 800-423-1174
 616-323-4433
 Fax: 800-423-7107
 E Mail: sales@select-hinges.com
 Web: www.select-hinges.com
 Bob Cronk Sales Mgr
Product Categories: B
See ad on page 123

Sensormatic

951 Yamato Rd.
 Boca Raton, FL 33431
 561-989-7295
 Fax: 561-898-7064
 Lou Chiara

Sentex Systems Inc.

9800 DeSoto Ave.
 Chatsworth, CA 91311
 818-700-9800
 Fax: 818-700-5000
 Web: www.sentexsystems.com
 Mark Stone
 Michael Bates
Product Categories: E

Sentinel Diversified Industries, Inc.

2043 Wellwood Ave
 East Farmingdale, NY 11735
 880-526-9000, 631-753-6000
 Fax: 631-753-6104
 E Mail: pete@sentineldiversified.com
 Web: www.l-sdi.com
 John Fitzpatrick
Product Categories: B E F

Sentry Group

900 Linden Ave.
 Rochester, NY 14625
 800-828-1438, 716-381-4900
 Fax: 716-381-8559
 E Mail: k_brosius@sentrysafe.com
 Web: www.sentrysafe.com
 Jim Brush Exec. VP Sales & Mktg.
 Togo DeBellist National Sales Mgr.
Product Categories: H

Sentry Security Fasteners

P.O. Box 10165
 Peoria, IL 61612
 Steve Cramer

Sentrylok Corp.

1930 Case Parkway
 Twinsburg, OH 44087
 800-883-1116, 330-425-1354
 Fax: 330-425-1884
 E Mail: info@sentrylok.com
 Web: www.sentrylok.com
 Scott Kuntz Pres.
 Robert Fox VP
Product Categories: A B E F

ShatterGard Security Window Films

8351 Roswell Rd #196
 Atlanta, GA 30350
 888-306-7998, 770-399-0064
 Fax: 770-730-0771
 E Mail: locksmith@shattergard.com
 Web: www.shattergard.com
 Jordan Frankel
See ad on page 116

Sidewinder Products Corp.

850 Municipal Drive
 Birmingham, AL 35216

205-979-0422
 Fax: 205-979-5118
 David Dodd

Sieveking Products Co.

P.O. Box 4287
 Rockford, IL 61109
 815-874-4030
 Fax: 815-874-5713
 E Mail: sievekingprodco@sievekingprodco.com
 Web: www.sievekingprodco.com
 Bob Sieveking Owner
 Jane Sieveking Mgr.
Product Categories: G



SingerTech

1925 Verne Roberts Circle
 Antioch, CA 94509
 925-777-0401
 Dave Singer

Skarnes Inc.

2907 E. Franklin Ave.
 Minneapolis, MN 55406
 800-752-7637, 612-339-9141
 Fax: 612-339-5749
 E Mail: skarnes@mn.state.net
 Dave Wanous
Product Categories: H

PRODUCT CATEGORY KEY

- A — Alarms
- B — Architectural Hardware
- C — Training Manuals & Materials
- D — Locksmith Software
- E — Electronic Security Products
- F — Locking Products
- G — Locksmith Tools & Equipment
- H — Safes & Safe Products

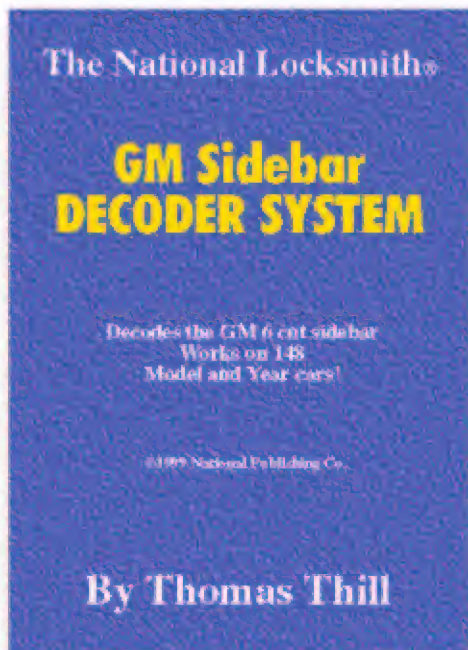

GM Sidebar Lock Decoder System

Tom Thill, the author of a new book, has invented an amazing new way to make keys for six cut GM Sidebar Locks.

CLICK HERE TO LEARN MORE



#TT - 1

Slide Lock Tool Co. Inc., Z Tool Div.

1166 Topside Rd.
Louisville, TN 37777
800-336-8812, 423-577-8470
Fax: 423-577-5936
D. Scott Selby
Product Categories: C G
See ad on page 101

Slideline Inc.

1111 Tahquitz Canyon
Palm Springs, CA 92262
760-945-0544
Fax: 760-945-8359
Dave Hutchison
Product Categories: F

Slydelock

25 Cousineau Street
Hull Quebec, Canada J8Y 3M9
800-664-5625, 819-770-1020
Fax: 819-771-5295
E Mail: marketing@slydelock.com
Web: www.slydelock.com
Robert Fugere President
Pierre Veillette R & D
Product Categories: B F

SoftLabs Inc.

9740 Acadie Blvd. Suite 201
Montreal Quebec, Canada H4N 1L8
514-332-0332
Fax: 514-332-9362
Andy Srougi

Southern CA Safe Company

510 W. Washington Blvd.
Montebello, CA 90640
Richard Rolland

Southern Steel Company

P.O. Box 2021
San Antonio, TX 78297
210-533-1231
Fax: 210-533-2211
Mike Sweet

Special-Lite Inc.

P.O. Box 6
Decatur, MI 49045
616-423-7068
Fax: 800-423-7610
Julie Brauer
Barbara Wielenga

Specialty Products Mfg. LLC

251 Captain Lewis Dr.
Southington, CT 06489
860-621-6969
Fax: 860-620-9372
David T. Randall Pres.
Product Categories: G

Speedypik Corp.

325 Rice Ave.
Revere, MA 02151
617-567-1111
Fax: 617-277-7777
Web: www.speedypik.com
William J. Cimino
Product Categories: D

St. Pierre Manufacturing Corp.

317 E. Mountain St.
Worcester, MA 01606
508-853-8010
Fax: 508-853-3860
Richard St. Pierre

Stanley Hardware Division

480 Myrtle St.
New Britain, CT 06050
860-827-5652
Fax: 860-827-5729

Steve N. Curran VP Sales
John W. Cooper VP Arch. Oper.
Product Categories: B E

STAT Lock

#2 Ellis Rd.
Havertown, PA 19083
800-286-7412, 610-872-7446
Fax: 610-872-6378
Jacqueline J. Schrader Pres.
Kenneth Schrader VP
Anthony Schrader VP
Product Categories: F

Steadfast Corporation

229 Marginal St.
Chelsea, MA 02150
800-342-5911, 617-889-3400
Fax: 617-889-2424
E Mail: STEADFAS@TIAC.NET
Mitko Zagoroff Pres.
Jim Easterwood Sales
Sandy Moy Mktg.
Product Categories: F

Steck Mfg. Co. Inc.

1115 South Broadway
Dayton, OH 45408
800-227-8325, 937-222-0062
Fax: 937-222-6666
E Mail: steckmfgco@earthlink.net
Raymond Steck Pres.
Laurence Steck VP
William Sharp Nat'l. Sales Mgr.
Product Categories: G
See ad on page 155

Strattec Security Corp.

3333 W. Goodhope Rd.
Milwaukee, WI 53209
414-247-3333 Fax: 414-247-3329
Andrea Tibbs Western Regional Sales Mgr
Scott Schroeder Eastern RSM
Fred Koslosk Central RSM
Product Categories: C E F G
See ad on page 61

Streamlight Inc.

1030 W. Germantown Pike
Norristown, PA 19403
800-523-7488, 610-631-0600
Fax: 610-631-0712
Web: www.streamlight.com
Mary Ellen Giangiulio
Brad Penney
Ray Sharrah
Product Categories: G

StrongArm Safe Drills & Rigs

2228 Kenry Way
S. San Francisco, CA 94080
800-710-8168, 650-952-7710
Fax: 650-794-0541
E Mail: jvdrills@aol.com
Jeff Volosing, President
Bob Volosing, VP
Product Categories: G H

Subterranean Data Storage

2033 3rd Ave. North
Lewiston, ID 83501
208-746-2188
Fax: 208-743-2799
E Mail: sdsco@sdsvaults.com
Web: www.sdsvaults.com
Jerry Adcock
John Adcock
Product Categories: E H

Suncoast Security Inc.

1931 West Bay Drive

Largo, FL 33770
800-441-2218, 727-530-7768
Fax: 727-585-2859
E Mail: suncoastlocks@cs.com
Product Categories: F

Sunroc Telkee

60 Starlifter Ave.
Dover, DE 19901
302-678-7800
Fax: 302-678-7809
E Mail: telkee@sunroc.com
Web: www.telkee.com
Lorraine Horrocks
Product Categories: B F

Supra Products

P.O. Box 3167
Salem, OR 97302
800-547-0252, 503-581-9101
Fax: 503-364-1285
Web: www.supra-products.com
Rick Boes Nat'l Acct Mgr
Terry Vulcani Dir. Sales & Mktg.
Barbara Camper Cust. Supp. Spec.
Product Categories: E F

Synco Chemical Corp

24 Darinci Dr
Bohemia, NY 11716
800-253-5823, 631-567-5300
Fax: 631-5675359
E Mail: info@super-lube.com
Web: www.super-lube.com
Sal A. Randisi II
Warren Walter
Martina Gaughan
Product Categories: G

Synergistics

9 Tech Circle
Natick, MA 01760
508-655-1340
Fax: 508-651-2902
E Mail: SYN@TIAC.NET
Web: www.SYNERGISTICSINC.COM
David Longworth President
Robert Pogorelc Vice President
Product Categories: E

Tanner Bolt & Nut Corp.

4302 Glenwood Rd.
Brooklyn, NY 11210
800-456-2658, 718-434-4500
Fax: 718-434-3215
E Mail: info@tannerbolt.com
Web: www.tannerbolt.com
Jeff Tanner Pres.
Gil Dagoberto Sales
Product Categories: F G

Taylor Building Products, Inc.

631 N. First St, P.O. Box 457
West Branch, MI 48661
800-248-3600, 517-345-5110
Fax: 517-345-5116
Web: www.taylorldoor.com
Stephen Sparer
Product Categories: B

Taymor Industries Inc.

1586 Zephyr Ave.
Hayward, CA 94544
800-388-9887, 510-429-0888
Fax: 510-429-0397
Andy Zalkow Pres.
Ron Viesterz Nat'l. Sales Mgr.
Product Categories: B

Tech-Train Productions

P.O. Box 15401
Pensacola, FL 32514
800-356-0136, 850-476-7197



Fax: 850-476-7410
 E Mail:
 techtrain@techtrainproductions.com
 Web: www.techtrainproductions.com
 Steve Young Owner
Product Categories: C G

Tektone Sound & Signal Mfg.

277 Industrial Park Road
 Franklin, NC 28734
 800-327-8466, 704-524-9967
 Fax: 704-524-9968

E Mail: tektone@tektone-sound.com
 Web: www.tektone-sound.com
 Manual Mira President
 Carlos Mira Vice President
 David Duelfer National Sales Manager
Product Categories: AE

Tekxon Inc.

112 S. Valley Rd.
 Lincoln Park, NJ 07035
 201-628-9430
 Fax: 201-628-1045
 Edward Diehl

Telstar Industries

12 Hunter
 Coto DeCaza, CA 92679
 714-459-0482
 Fax: 714-459-0483
 Ron Collins

TESA Inc.

P.O. Box 620138
 Atlanta, GA 30362
 800-472-8372
 David Figurelli
Product Categories: E F H

The Buster

2955 Geary Ave.
 San Francisco, CA 94118
 415-876-3100
 Sadie Jacobs

Thorvie International

1516 Buffalo St.
 Green Bay, WI 54313
 920-497-0572
 Web: www.Thorvie.com
 Al Viegut
Product Categories: G

TigerLine Equipment

P.O. Box 58
 Minster, OH 45865
 Brian Siefring

Timberline Lock Ltd.

915 Sherwood Dr.
 Lake Bluff, IL 60044
 800-562-5227, 847-234-1864
 Fax: 847-234-7922
 E Mail: sales@timberlinelock.com
 Web: www.timberlinelock.com
 Gregg Walla, Pres.
Product Categories: F

Timemaster Inc.

127 SE 29th Street
 Topeka, KS 66605
 888-798-8464
 Fax: 800-798-TIME
 E Mail: timstr@aol.com
 Web: www.time-master.com
 Dan Graffeo
Product Categories: C E G H

Titan Tool Co.

P.O. Box 569
 Buffalo, NY 14207
 716-873-9907
 Ted Tahn

Trans-Atlantic Company

440 Fairmount Ave.
 Philadelphia, PA 19123
 800-523-9956, 215-629-0400
 Fax: 800-531-0844
 E Mail: tacoj@aol.com
 Web: www.transatlantic.com
 Norman Millman
 Bernie Davis VP Sales
 Richard Seideman Oper. Mgr.
Product Categories: B F

Treskat USA

725 Adriane Park Circle
 Kissimmee, FL 34744
 800-645-5657, 407-870-9696
 Fax: 407-870-8505
 Web: www.TRESKAT.COM
 Ray Nazarro Pres.
Product Categories: D
See ad on page 126

Trimec

132 W. Maple Street
 Grafton, WI 53024
 800-987-4632
 Fax: 404-871-1870
 E Mail: sales@trimec-usa.com
 Web: www.trimec-usa.com
 Rick Steger
Product Categories: E F

Trine Access Technology

1440 Ferris Place
 Bronx, NY 10461
 718-829-6405
 Fax: 718-829-6405
 E Mail: customerservice@trineonline.com
 Web: www.trineonline.com
 William J. Schildwachter, VP
 Ed Cass National Sales Mgr.,
 Rosemarie Foley Costumer Service
 Coordinator
Product Categories: E F

Tripp Lite

1111 W. 35th St.
 Chicago, IL 60609
 773-869-1111
 Fax: 773-869-1329
 E Mail: info@tripplite@mcimail.com
 Web: www.tripplite.com
 Ray Foster Nat'l. Sales Mgr.
 Cathy Vala P/R
Product Categories: G

Tri-Star Products (Door Armor)

P.O. Box 713
 Harbor City, CA 90710
 310-325-8016
 Fax: 310-325-8016
 Ron Morningstar
Product Categories: F

Tru Hone Corporation

1721 NE 19th Ave.
 Ocala, FL 34470
 800-237-4663, 904-622-1213
 Fax: 904-622-9180
 E Mail: TRUHONE@TRUHONE.COM
 Web: www.truhone.com
 James Ganglehoff VP

Truecraft Tools

615 Pierce St
 Somerset, NJ 08875
 800-532-8665, 732-805-7800
 Fax: 732-805-9736
 E Mail: info@truecrafttools.com
 Web: www.truecrafttools.com
 Pete Pallatta
Product Categories: G



Tufloc Mfg. by Esmet

1406 Fifth St.
 Canton, OH 44702
 800-321-0870, 330-452-9132
 Fax: 330-452-2557
 Web: www.esmet.com
 Mike Waryas
Product Categories: F H
See ad on page 104

U-Change Lock Industries Inc.

1640 West Highway 152
 Mustang, OK 73064
 800-253-5625, 405-376-1600
 Fax: 405-376-6870
 E Mail: REKEY@U-CHANGE.COM
 Web: www.u-change.com
 Russell Myers VP Sales & Mktg.
 Bill Dillard Pres.
Product Categories: B F H

Ultra Hardware Products

1777 Hylton Rd. Dept. TNL-BG
 Pennsauken, NJ 08110
 800-426-6379, 609-663-5050
 Fax: 800-858-7210
 Daniel Carpey President
 Steve Sales ext. 530
 Jill T/M ext. 541
Product Categories: B F

United Business Computers

22485 LaPlama Ave. Suite 200
 Yorba Linda, CA 92887
 714-692-0083 Fax: 714-692-1889
 Web: www.ubcinc.com
Product Categories: D

United Security Products

11025 Sorrento Valley Ct.
 San Diego, CA 92121
 619-597-6677
 Fax: 619-455-0036
 Keith Gallen

Universal Industrial Products Co.

One Coreway Drive
 Pioneer, OH 43554
 800-922-6957, 419-737-2324
 Fax: 419-737-2130
 E Mail: hinges@sooss.com
 Web: www.soss.com
 Neil L. Marko President
 Richard Frankel Vice President Sales & Mktg.
 Susie Cagle
Product Categories: B

Unlocks Inc.

PO Box 6774
 Ozona, FL 34660
 800-865-6257, 727-934-7022
 Fax: 727-934-1803
 E Mail: UnlocksInc@aol.com
 Web: www.1-800-unlocks.com
 Jeff Musser President/COO
 Duane Musser Chairman CEO
See ad on page 121

Utilimaster

P. O. Box 585
 Wakarusa, IN
 219-862-4561 Fax: 219-862-4517
 Steve Campbell Comm. Sales

PRODUCT CATEGORY KEY

- A — Alarms
- B — Architectural Hardware
- C — Training Manuals & Materials
- D — Locksmith Software
- E — Electronic Security Products
- F — Locking Products
- G — Locksmith Tools & Equipment
- H — Safes & Safe Products

Vanguard Manufacturing Co.

P.O. Box 247
New Ipswich, NH 03071
800-624-5000 X124, 603-878-3273
Mark Tremblay

Vern Rose Tool

8605 Commerce Ave. Ste. A
San Diego, CA 92121
858-695-3384
Fax: 858-695-3387
Dennis Pinn Owner
Product Categories: G

Videx

1105 NE Circle Blvd.
Corvallis, OR 97330
541-758-0521
Fax: 541-752-5285
E Mail: sales@videx.com
Web: www.videx.com
Matt Misch
Product Categories: E F
See ad on page 67

Vigilante Burglar Bars Inc.

1685 Boone Ave
Bronx, NY 10460
718-328-3700
Fax: 718-893-7168
E Mail: vigilock@aol.com
Web: www.vigilock.com
Larry Kaufman Sales Mgr.
Product Categories: F

Vingcard

9333 Forest Lane
Dallas, TX
214-907-2273
Steve Hovanetz

Visonic Inc.

10 Northwood Drive
Bloomfield, CT 06002

800-223-0020, 860-243-0833
Fax: 860-242-8094
E Mail: info-usa@visonic.com
Web: www.visonic.com
Eileen O'Charek
Product Categories: A E F
See ad on page 68

Von Duprin Inc.

P.O. Box 6023
Indianapolis, IN 46219
317-897-9944
Fax: 317-899-9302
Don McAtee Nat'l. Sales Mgr.
Product Categories: B E

Walvaults Inc.

3900 W. Ponderosa Way #4
Las Vegas, NV 89118
800-528-4089, 702-222-1030
Fax: 702-736-6169
E Mail: Sales@rsfab.com
Web: www.rsfab.com
Robert Sheetz
Product Categories: H

WD-40 Co.

P.O. Box 80607
San Diego, CA
619-275-1400
Fax: 619-275-5823
Web: www.wd40.com
Garry Ridge Pres./CEO
Graham Minler
Steve Schwab
Product Categories: G

Weiser Lock

6660 S. Broadmoor Rd.
Tucson, AZ 85746
520-741-6242
Fax: 520-741-6241
Vern Schroeder Pres.

Weslock National Inc.

13344 S. Main St.
Los Angeles, CA 90061
800-575-BOLT (2658), 310-327-2770
Fax: 310-324-4624
Robert Pacelli VP Sales & Mktg.
Stevan M. Kinney Pres.
Kevin Gallagher CFO
Product Categories: F

Wilson Bohannon Co.

P.O. Drawer 504
Marion, OH 43301
740-382-3639
Fax: 740-383-1653
Eric Heaton

Wilson Safe Co.

P.O. Box 5310
Philadelphia, PA 19153
800-345-8053, 215-492-7100
Fax: 215-492-7104
E Mail: WILSONSAFE@AOL.COM
Web: www.wilsonsafe.thomasregister.com
Ray Wilson President
Margie Larkin
Product Categories: H

Winner International

32 West State St.
Sharon, PA 16146
412-981-1152
Fax: 412-981-1034
John Van Fassan

W-LOK

861 Productions Place
Holland, MI 49423
877-355-WLOK
616-355-4015

Fax: 616-355-4295
E Mail: office@wlokcorp.com
Web: www.wlokcorp.com
Diane Broekhuis
Rudy Broekhuis
Troy Abernathy
Product Categories: F

XL Lock Mfg.

2624 Lavery Court
Newbury Park, CA 91320
805-499-9727
Fax: 805-499-8208
E Mail: info@xllock.com
Web: www.xllock.com
Kevin Holden Pres.
Georgia Allan VP
Product Categories: F

Xperinetix

PO Box 502607
San Diego, CA 92150-2607
888-698-7477
858-485-0676
Fax: 856-485-0676
John Ulaszek

Yale Security Group Inc.

1902 Airport Rd.
Monroe, NC 28110
800-438-1951, 704-283-2101
Fax: 800-338-0965
E Mail: kjonila@yalesecurity.com
Web: www.yalesecurity.com
Jack Carlson CEO.
David L. Myers VP Mktg.
Thomas P. Kaika VP Sales
Product Categories: B

Yortec Inc.

20416 E. Walnut Dr. # 2a
Walnut, CA 91789
909-595-8512
Fax: 909-468-2685
E Mail: sales@yortec.com
Web: www.yortec.com
Joe Chang
Product Categories: E F

Young Bros. Stamp Works

P.O. Box 75
Muscatine, IA 52761
800-553-8248, 319-263-3575
Fax: 319-263-8003
Web: www.youngbrosstampworks.com
Jim Young Pres.
Debra Mathis
Randy Johnson
Product Categories: G
See ad on page 161

Zero International Inc.

415 Concord Ave.
Bronx, NY 10455
800-635-5335, 212-585-3230
Fax: 212-292-2243
E Mail: ZERO@INTERPORT.NET
Web: www.interport.net/zero
Elias Wexler Pres.
Stephen F. Petko Sales Mgr.
Michael Gardner Plant Mgr.
Product Categories: B



PRODUCT CATEGORY KEY

- A — Alarms
- B — Architectural Hardware
- C — Training Manuals & Materials
- D — Locksmith Software
- E — Electronic Security Products
- F — Locking Products
- G — Locksmith Tools & Equipment
- H — Safes & Safe Products

Transponders

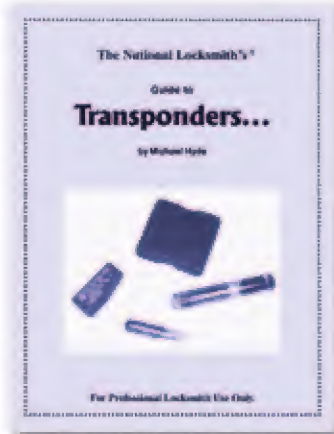

CLICK HERE TO LEARN MORE



#TS - 2001

MANUFACTURERS BY PRODUCT

ALARMS

American Auto Accessories Inc.

800-THE-1800, 718-458-6200
Fax: 718-458-9110
E Mail: aaanyusa@aol.com
Web: www.3aracing.com

AMSECO

800-421-1096, 310-538-4670
Fax: 310-538-9932
E Mail: info@amseco-kai.com
Web: www.amseco-kai.com

APR Industries Inc.

800-729-2674, 973-983-0880
Fax: 800-646-8721
E Mail: info@aprusa.com
Web: www.Aprusa.com

Arrow Lock Mfg. Co.

800-233-0478, 718-257-4700
Fax: 718-649-9097

Belwith International Ltd.

800-235-9484, 616-531-4300
Fax: 616-531-2995

Concord Electronic Access

888-972-6626, 718-972-5415
Fax: 888-962-6626
E Mail:
CONCORDEL@AOL.COM

Detex Corp.

800-729-3839, 830-629-2900
Fax: 830-620-6711
Web: www.detex.com

Domino Engineering Corporation

800-736-6466, 217-824-9441
Fax: 217-824-3349
E Mail: domino@chipsnet.com
Web:
www.dominoengineering.com

Door Controls Int'l.

800-742-3634, 734-426-0400
Fax: 800-742-0410
E Mail:
sales@doorcontrols.com
Web: www.doorcontrols.com

Dor-O-Matic a Division of Ingersoll-Rand

800-815-1517
Fax: 800-666-0472

Fort Lock Corp.

708-456-1100
Fax: 708-456-9476
E Mail: info@fortlock.com
Web: www.fortlock.com

Harrison Electronic Systems

800-422-5050, 717-825-0540
Fax: 717-823-6343
E Mail:
hesinc@ix.netcom.com
Web: www.harrison-hellfire.com

Hirsch Electronics Corporation

949-250-8888
Fax: 949-250-7372
E Mail:
johnp@hirschelectronics.com
Web:
www.hirschelectronics.com

Ilco Unican/Electronic Access Control Div.

800-786-9573
Fax: 973-490-3785
E Mail: ilco600@netcom.com
Web: www.ilcounican.com

Interactive Technologies Inc.

800-777-5484, 651-777-2690
Fax: 651-779-4879
E Mail: iti@ititechnologies.com
Web: www.ititechnologies.com

Kouba & Associates Inc.

877-873-4692, 512-303-5033
Fax: 512-312-4692
E Mail: jacquie@onr.com
Web: www.koubasystems.com

KXL Manufacturing Corp.

708-453-1788
Fax: 708-456-9476

L&S Security Products

310-329-2268
Fax: 310-532-4988
E Mail: lssedprod@aol.com
Web:
members.aol.com/lssedprod/
index.html

Lexxel Lock Mfg.

888-972-6626, 718-972-5415
Fax: 718-972-4239
E Mail: lexxellock@aol.com

Lion Security Products

800-477-7657, 612-789-7657
Fax: 612-789-0706

Mosler Inc.

800-MOSLER-1, 513-870-1900
Fax: 513-870-1175
Web: www.mosler.com

Mr. Chime Inc.

877-MRCHIME, 949-366-9435
Fax: 949-366-9436
E Mail: info@mrchime.com
Web: www.mrchime.com

Mytek America

800-228-0896, 818-352-4994
Fax: 818-352-9794
E Mail: mytek@ix.netcom.com

PCSC

310-638-0400
Fax: 310-638-6204
E Mail: SALES@1PCSC.COM
Web: www.1PCSC.COM

Phoenix Industries Inc.

800-238-3203, 913-723-3203
Fax: 913-723-3507
E Mail: sharonc@unicom.net
Web: www.ndiyp.com

RB Enterprises

800-452-5276, 209-642-2710
Fax: 209-642-2699

Safety Technology International Inc.

800-888-4784, 248-673-9898
Fax: 248-673-1246
E Mail: INFO@STI-USA.COM
Web: www.sti-usa.com

SECO-LARM USA INC.

800-662-0800, 949-261-2999
Fax: 949-261-7326
E Mail: info@seco-larm.com
Web: www.seco-larm.com

Securitech Group Inc.

800-625-LOCK, 718-392-9000
Fax: 718-392-8944
E Mail: securitech@aol.com
Web: www.securitech.com

Sentrylok Corp.

800-883-1116, 330-425-1354
Fax: 330-425-1884
E Mail: info@sentrylok.com
Web: www.sentrylok.com

Tektone Sound & Signal Mfg.

800-327-8466, 704-524-9967
Fax: 704-524-9968
E Mail: TEKSTONE@TEKSTONE-SOUND.COM
Web: www.tektone-sound.com

Visonic Inc.

800-223-0020, 860-243-0833
Fax: 860-242-8094
E Mail: info-usa@visonic.com
Web: www.visonic.com

ARCHITECTURAL HARDWARE

Aable Locksmiths

718-847-1377
Fax: 718-847-0991

ABH Manufacturing

847-437-9901
Fax: 800-932-9224
E Mail: abhinfo@abhmf.com
Web: www.abhmf.com

Abloy Door Security

800-465-5761, 514-335-9500
Fax: 800-730-3570
E Mail: info@abloy.ca
Web: www.abloy.com

Access Denied Inc.

800-348-5115, 219-244-3692
Fax: 219-244-4158
E Mail:
RJBAGAN@ULTRADOG.COM
Web: www.ultradog.com

Accurate Lock & Hardware Co.

203-348-8865
Fax: 203-348-5234
E Mail: accuratelj@aol.com
Web: www accuratelockhardw
are.com

Adams Rite Manufacturing Co.

800-872-3267, 909-632-2300
Fax: 909-632-2370
Web: www.Adamsrite.com

Adapt-A-Bore

800-829-8905, 414-291-5684
Fax: 414-291-5685
E Mail: aspurich@execpc.com
Web: www.doorhardware.net

Advanced Hardware

Technologies
800-523-9956, 215-629-0400
Fax: 800-531-0844
E Mail: TACOJ@AOL.COM.
Web: www.transatlanticco.com

APR Industries Inc.

800-729-2674, 973-983-0880
Fax: 800-646-8721
E Mail: info@aprusa.com
Web: www.Aprusa.com

Arrow Lock Mfg. Co.

800-233-0478, 718-257-4700
Fax: 718-649-9097

ASSA

800-235-7482
718-927-2772 ext.450
Fax: 718-257-2772
Web: www.assalock.com

Baldwin Hardware Corp.

800-437-7448, 610-777-7811
Fax: 610-775-5564

Baton Lock & Hardware Co. Inc.

800-395-8880, 714-265-3636
Fax: 714-265-3630
E Mail: batonlock@aol.com
Web: www.batonlockusa.com

CalRoyal Products

800-876-9258, 323-888-6601
Fax: 323-888-6699
E Mail: sales@car-royal.com
Web: www.car-royal.com

Carlson's Lock Service

562-862-5400
Fax: 562-949-4627

CCL Security Products

800-733-8588, 860-229-6199
Fax: 860-223-7601
E Mail: PRESTOLOX@AOL.COM
Web: www.cclsecurity.com

Concord Electronic Access

888-972-6626, 718-972-5415
Fax: 888-962-6626
E Mail: CONCORDEL@AOL.COM

Corbin Russwin Architectural Hardware

860-225-7411
Fax: 860-828-7266

Detex Corp.

800-729-3839, 830-629-2900
Fax: 830-620-6711
Web: www.detex.com

Don-Jo Manufacturing

800-628-8389, 978-422-3377
Fax: 978-422-3467
E Mail: don-jo@don-jo.com

Door Aid Corp.

800-493-8377, 616-324-5978
Fax: 616-324-5983

Door Controls Int'l.

800-742-3634, 734-426-0400
Fax: 800-742-0410
E Mail: sales@doorcontrols.com
Web: www.doorcontrols.com

Door Motion Technologies

800-291-1561, 616-321-9330
Fax: 616-327-6158
E Mail: doormotion@aol.com

Dorma Architectural Hardware/The DORMA Group N. A.

800-523-8483, 717-336-3881
Fax: 717-336-2106
E Mail: archdw@dorma-usa.com
Web: www.dorma-usa.com

Dor-O-Matic a Division of Ingersoll-Rand

800-815-1517
Fax: 800-666-0472

EMTEK Products Inc.

800-356-2741, 818-961-0413
Fax: 800-577-5771

Folger Adam Security Incorporated

800 438 1951
Fax: 740-283-2101
E Mail: mrobinson@yalesecurity.com

Fort Lock Corp.

708-456-1100
Fax: 708-456-9476
E Mail: info@fortlock.com
Web: www.fortlock.com

Gainsborough Hardware Ind. Inc.

800-845-5662, 770-448-9000
Fax: 770-448-7070

Glynn-Johnson

800-525-0336, 317-894-9440
Fax: 800-525-0337

G-U Hardware Inc.

800-927-1097, 757-873-1097
Fax: 757-873-1298
E Mail: G-U@G-U.COM
Web: www.g-u.com

H.B. Ives

203-294-4837
Fax: 203-284-1460

Hager Hinge Co.

800-325-9995, 314-772-4400
Fax: 800-782-0149
E Mail: rbeavers@hagerhinge.com

Hardware Technologies Ltd.

920-563-2626
Fax: 920-563-4408
E Mail: info@us.hoppe.com
Web: www.us.hoppe.com

HEWI Inc.

717-293-1313
Fax: 717-293-3270

Intellikey Corporation

800-226-0703, 407-724-0700
Fax: 407-724-0811
E Mail: info@intellikey.com
Web: www.intellikey.com

Italbrass Corporation

617-639-1992
Fax: 617-639-2458

Jado Bathroom & Hardware Mfg. Corp.

800-227-2734, 480-951-2675
Fax: 480-951-7165
Web: www.jado.com

Keedex Inc.

714-636-5657
Fax: 714-636-5680
E Mail: INFO@KEEDEX.COM
Web: www.keedex.com

L&S Security Products

310-329-2268
Fax: 310-532-4988
E Mail: lssecprod@aol.com
Web: members.aol.com/lssecprod/index.html

Ladyfayre Holdings LTD

800-579-0737, 403-258-2588
Fax: 403-640-4215
E Mail: ladyfayre@ultralink.com

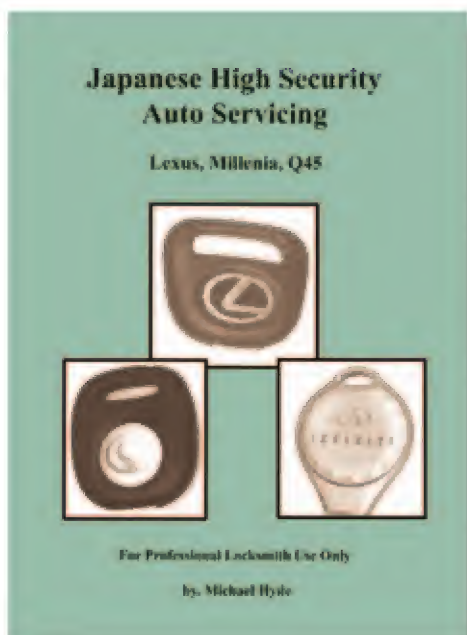

Japanese High Security

Some of the most profitable cars are also the trickiest to work on.

CLICK HERE TO LEARN MORE



#JAP - 1

ARCHITECTURAL HARDWARE (CONTINUED)

Latch-Gard Co. Inc.

219-862-2373
Fax: 219-862-2459

Lexxel Lock Mfg.

888-972-6626, 718-972-5415
Fax: 718-972-4239
E Mail: lexxellock@aol.com

M.A.G. Eng. & Mfg. Inc.

800-624-9942, 714-891-5100
Fax: 714-892-6845
E Mail: mageng@mindspring.com
Web: www.magsecurity.com

Magnokrom Inc.

905-671-2525
Fax: 905-671-2888
E Mail: info@magnokrom.com
Web: www.magnokrom.com

Major Metalfab Inc. (MMF)

800-445-8293, 847-537-7890
Fax: 847-537-1120
E Mail: mmmfind@wwa.com
Web: www.mmmfind.com

Markar Products Inc.

800-866-1688, 716-685-4104
Fax: 716-685-3919
E Mail: custsupp@markar.com
Web: www.markar.com

MARKS U.S.A.

800-526-0233, 631-225-5400
Fax: 631-225-6136
E Mail: wjs@marksusa.com
Web: www.marksusa.com

Marray Enterprises Inc

800-500-1449, 408-970-0213
Fax: 408-970-8767
E Mail: ray@marray.com
Web: www.marray.com

Master Lock Company

414-444-2800
Fax: 414-444-0322

Maxim Technologies Inc.

718-847-1352
Fax: 718-805-4438

Miwa Lock Canada/ Aline Distributors

888-451-6545
Fax: 780-452-7551

Miwa Lock USA

800-397-4631, 702-454-9888
Fax: 702-454-4577
E Mail: miwalockusa@aol.com
Web: www.miwalockusa.com

Monarch Hardware & Mfg. Co.

800-826-5792, 502-543-2281
Fax: 800-924-3551
E Mail:

monarch@ingerrand.com
Web:
www.monarchhardware.com

Morning Industries

909-869-0552
Fax: 909-869-5663
E Mail: morningindustries@yahoo.com
Web: www.morningindustries.com

Mul-T-Lock USA Inc.

800-562-3511, 973-778-3222
Fax: 973-778-4007
E Mail: MTLUSA@AOL.COM
Web: www.Mul-T-Lock.com

Omnia Industries Inc.

973-239-7272
Fax: 800-542-7611

PDQ Industries

800-441-9692, 717-656-4281
Fax: 717-656-6892
E Mail: PDQ@PPTNET.COM
Web: www.pptnet.com/pdq

PEMCO Mfg. Co.

800-283-9988, 805-642-2600
Fax: 805-642-4109
E Mail: SALES@PEMCO.COM
Web: www.pemco.com

Period Brass

800-332-6677
Fax: 800-215-8837

Phoenix Industries Inc.

800-238-3203, 913-723-3203
Fax: 913-723-3507
E Mail: sharonc@unicom.net
Web: www.ndiyp.com

Precision Hardware

734-326-7500
Fax: 734-326-7540

Prime-Line Products Co.

800-255-3505, 909-887-8118
Fax: 909-880-8968
E Mail: JFRI@PLP.mhs.COMPUSERVE.com

R.R. Brink Locking Systems Inc.

815-744-7000
Fax: 815-744-7020
E Mail: rbrink@rrbrink.com

Reading Industries

888-428-4593
610-374-0776 x 3054
Fax: 610-374-9088

ROFU International Corp.

800-255-ROFU, 253-922-1828
Fax: 253-922-1728
E Mail: julie.rofu@prodogy.net
Web: www.rofu.com

Rudolph-Desco Company Inc.

201-568-4920
Fax: 201-568-0971

S. Parker Hardware Mfg. Corp.

800-S-PARKER, 201-569-1600
Fax: 201-569-1082
E Mail: hardware@sparker.com
Web: www.Sparker.com

SAFLOK

800-LOCKS-33, 562-5733
714-722-5400
Fax: 714-722-0129
E Mail: PHIL@CSSMAIN.COM
Web: www.winfieldlock.com

Sargent & Greenleaf Inc.

800-826-7652, 859-885-9411
Fax: 859-887-2057
E Mail: custsvc@sglocks.com
Web: sglocks.com

Sargent Manufacturing Co.

800-727-5477, 203-562-2151
Fax: 888-863-5054
E Mail: webmaster@sargentlock.com
Web: www.sargentlock.com

Schlage Commerical Lock Division

800-847-1864, 719-264-5300
Fax: 719-264-5382
Web: www.schlage.com

Securitech Group Inc.

800-625-LOCK, 718-392-9000
Fax: 718-392-8944
E Mail: securitec@aol.com
Web: www.securitech.com

Security Distributors Incorporated

214-879-15555
Fax: 214-879-1525
Web: www.uscanlock.com

Security Latch

800-633-6622, 906-484-3120
Fax: 906-484-2761
E Mail: seclat@sault.com
Web: www.securitylatch.com

Select Products Limited

800-423-1174, 616-323-4433
Fax: 800-423-7107
E Mail: sales@select-hinges.com
Web: www.select-hinges.com

Sentinel Diversified Industries, Inc.

880-526-9000, 631-753-6000
Fax: 631-753-6104
E Mail: pete@sentineldiversified.com
Web: www.l-sdi.com

Sentrylok Corp.

800-883-1116, 330-425-1354
Fax: 330-425-1884
E Mail: info@sentrylok.com
Web: www.sentrylok.com

Slydelock

800-664-5625, 819-770-1020
Fax: 819-771-5295
E Mail: marketing@slydelock.com
Web: www.slydelock.com

Stanley Hardware Division

860-827-5652
Fax: 860-827-5729

Sunroc Telkee

302-678-7800
Fax: 302-678-7809
E Mail: telkee@sunroc.com
Web: www.telkee.com

Taylor building products, Inc.

800-248-3600, 517-345-5110
Fax: 517-345-5116
Web: www.taylor-door.com

Taymor Industries Inc.

800-388-9887, 510-429-0888
Fax: 510-429-0397

Trans-Atlantic Company

800-523-9956, 215-629-0400
Fax: 800-531-0844
E Mail: tacob@aol.com
Web: www.transatlantic.com

U-Change Lock Industries Inc.

800-253-5625, 405-376-1600
Fax: 405-376-6870
E Mail: rekey@u-change.com
Web: www.u-change.com

Ultra Hardware Products

800-426-6379, 609-663-5050
Fax: 800-858-7210

Universal Industrial Products Co.

800-922-6957, 419-737-2324
Fax: 419-737-2130
E Mail: hinges@sooss.com
Web: www.sooss.com

Von Duprin Inc.

317-897-9944
Fax: 317-899-9302

Yale Div. of Yale Security Inc.

704-283-2101
Fax: 704-289-2875

Yale Security Group Inc.

800-438-1951, 704-283-2101
Fax: 800-338-0965
E Mail: kjonila@yalesecurity.com
Web: www.yalesecurity.com

Zero International Inc.

800-635-5335, 212-585-3230
Fax: 212-292-2243
E Mail: ZERO@INTERPORT.NET
Web: www.interport.net/zero

**TRAINING
 MANUALS &
 MATERIALS**

A-I Security Mfg. Corp.

877-725-2121, 804-359-9003
 Fax: 804-359-9415
 E Mail: FMCC @
 demanda1.COM

APR Industries Inc.

800-729-2674, 973-983-0880
 Fax: 800-646-8721
 E Mail: info@aprusa.com
 Web: www.Aprusa.com

Base Industries

800-554-8088, 909-371-4465
 Fax: 909-371-2828
 E Mail:
 BASEBOY@EARTHLINK.NET

**BWDAutomotive -
 Alabama**

800-647-4926, 334-872-6526
 Fax: 334-874-6011

**Canadian Locksmith,
 The Magazine**

905-294-0660
 Fax: 905-294-0394
 E Mail: TCLARSIN@ICA.NET

**Corbin Russwin
 Architectural
 Hardware**

860-225-7411
 Fax: 860-828-7266

**Folger Adam Security
 Incorporated**

800 438 1951
 Fax: 740-283-2101
 E Mail:
 mrobinson@yalesecurity.com

Fort Lock Corp.

708-456-1100
 Fax: 708-456-9476
 E Mail: info@fortlock.com
 Web: www.fortlock.com

High Tech Tools

800-323-8324, 305-649-7014
 Fax: 305-541-0074
 E Mail:
 sales@hightechnology.com
 Web: www.hightechnology.com

HPC Inc.

800-323-3295, 847-671-6280
 Fax: 847-671-6343
 E Mail: hpc@hpcworld.com
 Web: www.hpcworld.com

**Interactive
 Technologies Inc.**

800-777-5484, 651-777-2690
 Fax: 651-779-4879
 E Mail: iti@ititechnologies.com
 Web: www.ititechnologies.com

Key Control Specialists

805-538-1478
 Fax: 310-640-8389

Locksmith.com

800-323-8324, 305-649-1207
 Fax: 305-541-0074

E Mail: webmaster@locksmith.com
 Web: www.locksmith.com

Markar Products Inc.

800-866-1688, 716-685-4104
 Fax: 716-685-3919
 E Mail: custsupp@markar.com
 Web: www.markar.com

**Medeco Security
 Locks Inc.**

800-839-3157, 540-380-5000
 Fax: 540-380-5010
 Web: www.medeco.com

**National
 Locksmith, The**

630-837-2044
 Fax: 630-837-1210
 E Mail: natlock@aol.com
 Web:
 www.TheNationalLocksmith.com

**National
 Safeman's
 Organization**

630-837-2044
 Fax: 630-837-1210
 E Mail: natlock@aol.com
 Web:
 www.TheNationalLocksmith.com

**National
 Locksmith
 Automobile
 Assn.**

630-837-2044

Fax: 630-837-1210
 E Mail: natlock@aol.com
 Web:
 www.TheNationalLocksmith.com

PRO-LOK

714-633-0681
 Fax: 714-633-0470

**Securitech Group
 Inc.**

800-625-LOCK, 718-392-9000
 Fax: 718-392-8944
 E Mail: securitec@ aol.com
 Web: www.securitech.com

**Slide Lock Tool Co.
 Inc., Z Tool Div.**

800-336-8812, 423-577-8470
 Fax: 423-577-5936

Strattec Security Corp.

414-247-3333
 Fax: 414-247-3329

**Tech-Train
 Productions**

800-356-0136, 850-476-7197
 Fax: 850-476-7410
 E Mail: techtrain@
 techtrainproductions.com
 Web:
 www.techtrainproductions.com

Timemaster Inc.

888-798-8464
 Fax: 800-798-TIME
 E Mail: timstr@aol.com
 Web: www.time-master.com

MANUFACTURERS by PRODUCT

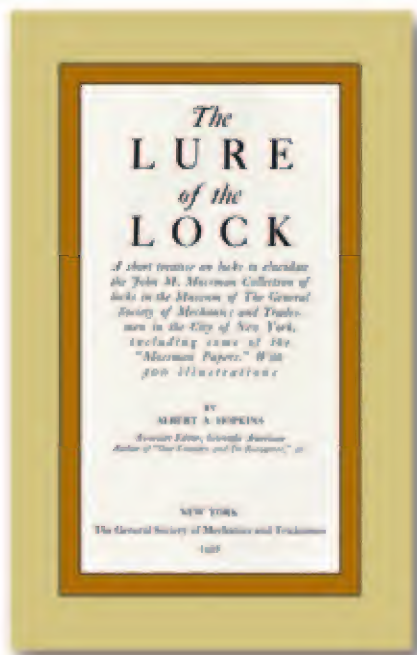

**The Lure of
 the Lock**

This hardcover book, compiled in 1928, features dozens and dozens of beautiful photographs on ancient through modern locks.

CLICK HERE TO LEARN MORE



#LURE

**LOCKSMITH
SOFTWARE**

**AutoSmart
Advisor**

630-837-2044
Fax: 630-837-1210
E Mail: natllock@aol.com
Web:
www.AutoSmartAdvisor.com

Blackhawk Products

970-882-7191
Fax: 970-882-7228
E Mail: staff2blackhawk7.com
Web: www.blackhawk7.com

**ClearStar Security
Network**

510-841-4807
Fax: 510-841-7915
E Mail: info@clearstar.com
Web: www.clearstar.com

**Corbin Russwin
Architectural
Hardware**

860-225-7411
Fax: 860-828-7266

**DALAX Inc. / H&L
Simon Co.**

972-234-8009
Fax: 972-234-0339
E Mail: simon@simon-says.net
Web: www.simon-says.net

Data-Basics

800-837-7574, 216-663-5600
Fax: 216-663-5454
E Mail: sam@datbasic.com
Web: www.datbasic.com

**DLA Security Systems
Inc.**

908-233-7755
Fax: 908-233-7755
E Mail: dlasec@pipeline.com
Web: www.dlaco.com

Eclipse, Inc.

800-9-eclipse, 770-625-4995
Fax: 770-625-4996
E Mail: info@eclipseinc.com
Web: www.eclipseinc.com

HPC Inc.

800-323-3295, 847-671-6280
Fax: 847-671-6343
E Mail: hpc@hpcworld.com
Web: www.hpcworld.com

**InstaCode
200 I**

630-837-2044
Fax: 630-837-1210
E Mail: natllock@aol.com
Web:
www.TheNationalLocksmith.com

Intellikey Corporation

800-226-0703, 407-724-0700
Fax: 407-724-0811
E Mail: info@intellikey.com
Web: www.intellikey.com

Key Control Specialists

805-538-1478
Fax: 310-640-8389

**KeySoft
Masterkeying
Software**

800-505-6636, 801-521-0869
E Mail: keysoft@burgoyne.com
Web: www.masterkeypro.com

Lockbutler, SBD Inc.

972-772-3471
Fax: 972-772-0526
E Mail: lockbutler@airmail.net
Web: www.lockbutler.com

**Locksmith Dispatcher
2000**

630-837-2044
Fax: 630-837-1210
E Mail: natllock@aol.com
Web: www.DiamondSoftware
Systems.com

Locksmith.com

800-323-8324, 305-649-1207
Fax: 305-541-0074
E Mail:
webmaster@locksmith.com
Web: www.locksmith.com

Locksoft Inc.

402-461-4149
Fax: 402-461-4359
E Mail: ls24242.navix.net
Web: www.locksoft.com

**MBI Business
Software**

800-551-4624, 916-444-2922
Fax: 916-393-0930
E Mail:
sales@mbisoftware.com
Web: www.mbisoftware.com/
locksmith.HTM

**National Locksmith
Automobile Assn.**

630-837-2044
Fax: 630-837-1210
E Mail: natllock@aol.com
Web:
www.TheNationalLocksmith.com

**National
Locksmith,
The**

630-837-2044
Fax: 630-837-1210
E Mail: natllock@aol.com
Web:
www.TheNationalLocksmith.com

**National Safeman's
Organization**

630-837-2044
Fax: 630-837-1210
E Mail: natllock@aol.com
Web:
www.TheNationalLocksmith.com

Pacel Corp.

703-257-4759
Fax: 703-361-6706
E Mail: locksmith@pacel.com
Web: www.pacel.com

PPM 2000 Inc.

888-776-9776, 403-448-0616
Fax: 403-448-0618
E Mail: info@ppm2000.com
Web: www.ppm2000.com

**Security Distributors
Incorporated**

214-879-15555
Fax: 214-879-1525
Web: www.uscanlock.com

Speedypik Corp.

617-567-1111
Fax: 617-277-7777
E Mail:
Web: www.speedypik.com

Treskat USA

800-645-5657, 407-870-9696
Fax: 407-870-8505
Web: www.TRESKAT.COM

**United Business
Computers**

714-692-0083
Fax: 714-692-1889
E Mail: rmyers@ubcinc.com
Web: www.ubcinc.com

**ELECTRONIC
SECURITY
PRODUCTS**

A&B Safe Corp.

800-253-1267, 856-863-1186
Fax: 856-863-1208
E Mail: info@a-bsafecorp.com
Web: www.a-bsafecorp.com

**Adams Rite
Manufacturing Co.**

800-872-3267, 909-632-2300
Fax: 909-632-2370
Web: www.Adamsrite.com

Adcour Inc.

800-232-3557, 781-935-9944
Fax: 781-937-3499

Advanced Signaling

817-275-8401
Fax: 817-274-3707

**Aiphone Intercom
Systems**

800-692-0200, 206-455-0510
Fax: 206-455-0071
Web: www.aiphone.com

**Alarm Lock Systems
Inc.**

800-ALA-LOCK, 516-789-4871
Fax: 516-842-9137
E Mail:
salesinfo@napcosecurity.com
Web: www.alarmlock.com

AlarmSaf

978-658-6717
Fax: 978-658-8638
E Mail: sales@alarmsaf.com
Web: www.alarmsaf.com

**American Security
Products Co.**

800-421-6142, 909-685-9680
Fax: 909-685-9685
E Mail: sec@amsecusa.com
Web: www.amsecusa.com

AMSECO

800-421-1096, 310-538-4670
Fax: 310-538-9932

E Mail: info@amseco-kai.com
Web: www.amseco-kai.com

**Architectural Control
Systems Inc.**

800-753-5558, 314-432-5588
Fax: 314-432-2090

Base Industries

800-554-8088, 909-371-4465
Fax: 909-371-2828
E Mail: baseboy@earthlink.net

**Besam Automatic
Door Systems**

800-752-9290, 609-443-5800
Fax: 609-443-3440

**Canadian Safe
Manufacturing**

800-267-7635, 905-528-7233
Fax: 905-528-7728

**Cansec
Systems Ltd.**

905-820-2404
Fax: 905-820-0301
E Mail: SALES@CANSEC.COM
Web: www.cansec.com

Cardkey Systems Inc.

805-522-5555
Fax: 805-526-0064

**Concord Electronic
Access**

888-972-6626, 718-972-5415
Fax: 888-962-6626
E Mail: concordel@aol.com

**Control Monitor
Systems**

888-247-6768, 714-892-8277
Fax: 714-892-1438
Web:
www.controlmonitor.com

**Corbin Russwin
Architectural
Hardware**

860-225-7411
Fax: 860-828-7266

Corby Industries Inc.

800-652-6729, 610-433-1412
Fax: 610-435-1963

**Creative Commands
Corp.**

310-530-1420
Fax: 310-530-9219
E Mail: cpathway@pacbell.com
Web: www.handytouch.com

**Cypress Computer
Systems, Inc**

800-807-2977, 810-245-2300
Fax: 810-245-2332
E Mail:
sales@cypresscom.com
Web: www.cypresscom.com

Detex Corp.

800-729-3839, 830-629-2900
Fax: 830-620-6711
Web: www.detex.com

ELECTRONIC SECURITY PRODUCTS (CONTINUED)

Domino Engineering Corporation

800-736-6466, 217-824-9441
Fax: 217-824-3349
E Mail: domino@chipsnet.com
Web: www.dominoengineering.com

Door Controls Int'l.

800-742-3634, 734-426-0400
Fax: 800-742-0410
E Mail: sales@doorcontrols.com
Web: www.doorcontrols.com

Door Motion Technologies

800-291-1561, 616-321-9330
Fax: 616-327-6158
E Mail: doormotion@aol.com

Doorguard Systems Inc.

800-442-6247, 410-992-5600
Fax: 410-992-5694
E Mail: info@doorguardsystems.com
Web: www.doorguardsystems.com

Dorma Architectural Hardware/The DORMA Group N. A.

800-523-8483, 717-336-3881
Fax: 717-336-2106
E Mail: archdw@dorma-usa.com
Web: www.dorma-usa.com

Dor-O-Matic a Division of

Ingersoll-Rand
800-815-1517
Fax: 800-666-0472

Dynalock Corporation

877-DYNALOCK, 860-582-4761
Fax: 860-585-0338
E Mail: DYNALOCK.CORP@SNET.NET
Web: www.dynalock.com

Engineering Solutions Inc

800-995-2334, 206-241-9395
Fax: 206-241-9411
E Mail: chris@engsolinc.com
Web: www.engsolinc.com

ESSEX Industries

800-539-5377, 805-684-7601
Fax: 805-684-0232

Everswitch

973-779-8774
Fax: 973-779-8768
E Mail: alan@barantec.com
Web: www.barantec.com

Farfisa Intercoms

800-806-0227, 305-593-0227
Fax: 305-593-9823
E Mail: FARFISA1@AOL.COM

Folger Adam Security Incorporated

800 438 1951
Fax: 740-283-2101
E Mail: mrobinson@yalesecurity.com

Fort Lock Corp.

708-456-1100
Fax: 708-456-9476
E Mail: info@fortlock.com
Web: www.fortlock.com

Frame Inc.

800-372-6346, 714-441-0544
Fax: 714-441-0543
E Mail: FRAMEINC.@JUNO.COM

Granite Security Products Inc.

817-561-9095
Fax: 817-478-3056
E Mail: BECKY@GRANITE.SAFE.COM
Web: www.graniteSafe.com

GTO Inc.

800-543-GATE, 850-575-0176
Fax: 850-575-8912
E Mail: gto@gtoinc.com
Web: www.gtoinc.com.

Harrison Electronic Systems

800-422-5050, 717-825-0540
Fax: 717-823-6343
E Mail: hesinc@ix.netcom.com
Web: www.harrison-hellfire.com

HES Inc.

800-626-7590, 623-582-4626
Fax: 623-582-4641
E Mail: service@hesinnovations.com
Web: www.hesinnovations.com

Hirsch Electronics Corporation

949-250-8888
Fax: 949-250-7372
E Mail: johnp@hirschelectronics.com
Web: www.hirschelectronics.com

Ilco Unican/Electronic Access Control Div.

800-786-9573
Fax: 973-490-3785
E Mail: ILCO600@NETCOM.COM
Web: www.ilcounican.com

Indiana Cash Drawer Co.

800-227-4379, 317-398-6643
Fax: 317-392-0958
E Mail: cshergit@icdpos.com
Web: www.icdpos.com

Industries CL Inc

514-683-6282
Fax: 514-683-9015
E Mail: clegault@legault-locks.com
Web: www.legault-locks.com

Info Graphic Systems Corp.

714-220-4980
Fax: 714-220-1828

Intellikey Corporation

800-226-0703, 407-724-0700
Fax: 407-724-0811
E Mail: INFO@INTELLIKEY.COM
Web: www.intellikey.com

Interactive Technologies Inc.

800-777-5484, 651-777-2690
Fax: 651-779-4879
E Mail: iti@ititechnologies.com
Web: www.ititechnologies.com

International Electronics Inc.

800-343-9502, 617-821-5566
Fax: 617-821-4443

KABA High Security Locks

860-621-3601
Fax: 860-621-9727

Keedex Inc.

714-636-5657
Fax: 714-636-5680
E Mail: INFO@KEEDEX.COM
Web: www.keedex.com

Keri Systems Inc.

800-260-5265, 408-451-2520
Fax: 408-441-0309
E Mail: sales@kerisys.com
Web: www.kerisys.com

Key Systems Inc.

800-888-3553, 716-924-7830
Fax: 716-924-3515
Web: www.keystorage.com

KEY-BAK; Div. of West Coast Chain Mfg. Co.

800-685-2403, 909-923-7800
Fax: 800-565-6202
E Mail: sales@keybak.com
Web: www.keybak.com

Kouba & Associates Inc.

877-873-4692, 512-303-5033
Fax: 512-312-4692
E Mail: jacquie@onr.com
Web: www.koubasystems.com

KXL Manufacturing Corp.

708-453-1788
Fax: 708-456-9476

L&S Security Products

310-329-2268
Fax: 310-532-4988
E Mail: LSSECPROD@AOL.COM
Web: members.aol.com/lsssecprod/index.html

La Gard Inc.

310-325-5670
Fax: 310-325-5615
E Mail: Susan.Papa@LAGARD.COM
Web: www.LAGARD.COM

Lexxel Lock Mfg.

888-972-6626, 718-972-5415
Fax: 718-972-4239
E Mail: lexxellock@aol.com

Lion Security Products

800-477-7657, 612-789-7657
Fax: 612-789-0706

Locknetics Security Engineering

860-584-9158
Fax: 860-584-2136
E Mail: INFO@LOCKNETICS.COM

Locksmith.com

800-323-8324, 305-649-1207
Fax: 305-541-0074
E Mail: webmaster@locksmith.com
Web: www.locksmith.com

Lonchar's Inc.

215-546-4422
Fax: 215-546-5979

MARKS U.S.A.

800-526-0233, 631-225-5400
Fax: 631-225-6136
E Mail: wjs@marksusa.com
Web: www.marksusa.com

Marlee Electronics

800-260-5265, 408-451-2520
Fax: 408-441-0309
E Mail: sales@kerisys.com
Web: www.kerisys.com

Murray Enterprises Inc

800-500-1449, 408-970-0213
Fax: 408-970-8767
E Mail: ray@murray.com
Web: www.murray.com

Mas Hamilton Group Inc.

888-950-4715, 800-950-4744
859-253-4744
Fax: 859-281-5776
E Mail: mhgmktg@mas-hamilton.com
Web: www.mas-hamilton.com

**ELECTRONIC
SECURITY
PRODUCTS
(CONTINUED)**

**McGunn Safe
Co. L.L.C.**

800-621-2816, 773-884-3560
Fax: 773-884-6560
E Mail: alanh@mcgunnsafe
Web: www.mcgunnsafe.com

**Medeco Security
Locks Inc.**

800-839-3157, 540-380-5000
Fax: 540-380-5010
Web: www.medeco.com

**Monarch Hardware &
Mfg. Co.**

800-826-5792, 502-543-2281
Fax: 800-924-3551
E Mail: monarch@ingerrand.com
Web:
www.monarchhardware.com

Moniteq Research Labs

800-989-9891, 703-569-0195
Fax: 703-569-0196

Morning Industries

909-869-0552
Fax: 909-869-5663
E Mail:
morningindustries@yahoo.com
Web:
www.morningindustries.com

**Morse Watchmans
Inc.**

800-423-8256, 203-264-4949
Fax: 203-264-8367

Mosler Inc.

800-MOSLER-1, 513-870-1900
Fax: 513-870-1175
Web: www.mosler.com

Mr. Chime Inc.

877-MRCHIME, 949-366-9435
Fax: 949-366-9436
E Mail: info@mrchime.com
Web: www.mrchime.com

Mytek America

800-228-0896, 818-352-4994
Fax: 818-352-9794
E Mail:
MYTEK@IX.NETCOM.COM

Nanotechnology Inc.

408-973-8280
Fax: 408-973-8280

NEL-TECH

800-874-2050, 219-874-7500
Fax: 219-874-9990

NKL Industries

800-528-9900, 757-485-0200
Fax: 757-485-0271

Optex (U.S.A.) Inc.

800-966-7839, 310-533-1500
Fax: 310-533-5910

OSI Security Devices

619-628-1000
Fax: 619-628-1001
E Mail: sales@omnilock.com
Web: www.omnilock.com

Pach & Company

714-498-2951
Fax: 714-498-6879

PCSC

310-638-0400
Fax: 310-638-6204
E Mail: SALES@1PCSC.COM
Web: www.1PCSC.COM

**Phoenix Industries
Inc.**

800-238-3203, 913-723-3203
Fax: 913-723-3507
E Mail: sharonc@unicom.net
Web: www.ndiyp.com

**Power Access
Corporation**

800-344-0088, 203-693-0751
Fax: 203-693-0641
E Mail:
POWACCESS@AOL.COM

Precision Hardware

734-326-7500
Fax: 734-326-7540

**R.R. Brink Locking
Systems Inc.**

815-744-7000
Fax: 815-744-7020
E Mail: rbrink@rrbrink.com

**RCI Rutherford
Controls
International Corp.**

800-899-5625, 757-427-1230
Fax: 757-427-9549
E Mail:
sales@rutherfordUSA.com
Web:
www.rutherfordcontrols.com

**ROFU
International
Corp.**

800-255-ROFU, 253-922-1828
Fax: 253-922-1728
E Mail: julie.rofu@prodogy.net
Web: www.rofu.com

**Safety Technology
International Inc.**

800-888-4784, 248-673-9898
Fax: 248-673-1246
E Mail: INFO@STI-USA.COM
Web: www.sti-usa.com

SAFLOK

800-LOCKS-33 or 562-5733
714-722-5400
Fax: 714-722-0129
E Mail: PHIL@CSSMAIN.COM
Web: www.winfieldlock.com

**Sargent & Greenleaf
Inc.**

800-826-7652, 859-885-9411
Fax: 859-887-2057
E Mail: custsvc@sglocks.com
Web: sglocks.com



**Dave McOmie
NSO & Article
Collection
on CD**

This CD contains every NSO
newsletter and McOmie File
Dave has ever published.

[CLICK HERE TO LEARN MORE](#)



#DMCD - 2

**ELECTRONIC
SECURITY
PRODUCTS
(CONTINUED)**

**Sargent
Manufacturing
Co.**

800-727-5477, 203-562-2151
Fax: 888-863-5054
E Mail:
webmaster@sargentlock.com
Web: www.sargentlock.com

**Schlage Commerical
Lock Division**

800-847-1864, 719-264-5300
Fax: 719-264-5382
Web: www.schlage.com

**SECO-LARM USA
INC.**

800-662-0800, 949-261-2999
Fax: 949-261-7326
E Mail: info@seco-larm.com
Web: www.seco-larm.com

Secura Key

800-891-0020, 818-882-0020
Fax: 818-882-7052
E Mail:
MAIL@SECURAKEY.COM
Web: www.securakey.com

**Securitech Group
Inc.**

800-625-LOCK, 718-392-9000
Fax: 718-392-8944
E Mail: SECURITEC @ AOL.
COM
Web: www.securitech.com

**Securitron Magnalock
Corp.**

800-MAG-LOCK, 775-355-5625
Fax: 775-355-5636
E Mail:
INFO@SECURITRON.COM
Web: www.securitron.com

**Security Distributors
Incorporated**

214-879-15555
Fax: 214-879-1525
Web: www.uscanlock.com

**Security Door
Controls**

805-494-0622
Fax: 805-494-8680
E Mail:
service@sdsecurity.com
Web: www.sdsecurity.com

Se-Kure Controls Inc.

800-322-2435, 847-288-1111
Fax: 847-288-9999
E Mail: SEKURE@MSN.COM
Web: www.se-kure.com

Sentex Systems Inc.

818-700-9800
Fax: 818-700-5000
Web:
www.sentexsystems.com

**Sentinel Diversified
Industries, Inc.**

880-526-9000, 631-753-6000
Fax: 631-753-6104
E Mail:
pete@sentineldiversified.com
Web: www.l-sdi.com

Sentrylok Corp.

800-883-1116, 330-425-1354
Fax: 330-425-1884
E Mail: info@sentrylok.com
Web: www.sentrylok.com

**Stanley Hardware
Division**

860-827-5652
Fax: 860-827-5729

**Strattec Security
Corp.**

414-247-3333
Fax: 414-247-3329

**Subterranean Data
Storage**

208-746-2188
Fax: 208-743-2799
E Mail: sdsco@sdsvaults.com
Web: www.sdsvaults.com

Supra Products

800-547-0252, 503-581-9101
Fax: 503-364-1285
Web: www.supra-
products.com

Synergistics

508-655-1340
Fax: 508-651-2902
E Mail: SYN@TIAC.NET
Web:
www.SYNERGISTICSINC.COM

**Tektone Sound &
Signal Mfg.**

800-327-8466, 704-524-9967
Fax: 704-524-9968
E Mail: TEKTONE@TEKTONE-
SOUND.COM
Web: www.tektone-
sound.com

TESA Inc.

800-472-8372

Timemaster Inc.

888-798-8464
Fax: 800-798-TIME
E Mail: timstr@aol.com
Web: www.time-master.com

Trimec

800-987-4632
Fax: 404-871-1870
E Mail: sales@trimec-usa.com
Web: www.trimec-usa.com

**Trine Access
Technology**

718-829-6405
Fax: 718-829-6405
E Mail:
customerservice@trineonline.com
Web: www.trineonline.com

Videx

541-758-0521
Fax: 541-752-5285
E Mail: sales@videx.com
Web: www.videx.com

Visonic Inc.

800-223-0020, 860-243-0833
Fax: 860-242-8094
E Mail: info-usa@visonic.com
Web: www.visonic.com

Von Duprin Inc.

317-897-9944
Fax: 317-899-9302

**Yale Div. of Yale
Security Inc.**

800-438-1951, 704-283-2101
Fax: 704-289-2875

Yortec Inc.

909-595-8512
Fax: 909-468-2685
E Mail: sales@yortec.com
Web: www.yortec.com

**LOCKING
PRODUCTS**

**A&B Manufacturing
Co. Inc.**

860-628-5030

A&B Safe Corp.

800-253-1267, 856-863-1186
Fax: 856-863-1208
E Mail: INFO@A-
BSAFECORP.COM
Web: www.A-
BSAFECORP.COM

ABH Manufacturing

847-437-9901
Fax: 800-932-9224
E Mail: abhinfo@abhmfg.com
Web: www.abhmfg.com

**Abloy Door
Security**

800-465-5761, 514-335-9500
Fax: 800-730-3570
E Mail: info@abloy.ca
Web: www.abloy.com

Abus Lock Co.

800-352-2287, 612-509-9933
Fax: 612-509-9939
E Mail:
74511.1570@COMPUSERVE.
COM
Web: www.abus.com

Access Denied Inc.

800-348-5115, 219-244-3692
Fax: 219-244-4158
E Mail:
RJBAGAN@ULTRADOG.COM
Web: www.ultradog.com

Accu-Lock Inc.

817-447-4085
Fax: 817-447-6534
E Mail: Rick@acculock.com
Web: www.acculock.com

**Accurate Lock &
Hardware Co.**

203-348-8865
Fax: 203-348-5234
E Mail: accuratelj@aol.com
Web:
www.accuratelockhardware.com

**Adams Rite
Manufacturing Co.**

800-872-3267, 909-632-2300
Fax: 909-632-2370
Web: www.Adamsrite.com

Adapt-A-Bore

800-829-8905, 414-291-5684
Fax: 414-291-5685
E Mail: aspurich@execpc.com
Web: www.doorhardware.net

**Advanced Hardware
Technologies**

800-523-9956, 215-629-0400
Fax: 800-531-0844
E Mail: TACOJ@AOLCOM.
Web:
www.TRANSATLANTICCO
.COM

**Aiphone Intercom
Systems**

800-692-0200, 206-455-0510
Fax: 206-455-0071
Web: www.aiphone.com

**Alarm Lock Systems
Inc.**

800-ALA-LOCK, 516-789-4871
Fax: 516-842-9137
E Mail:
salesinfo@napcosecurity.com
Web: www.alarmlock.com

**All-Safe Security
Systems Ltd.**

403-212-5660
Fax: 403-259-5110
E Mail: allsafe@allsafesec.com
Web: www.allsafesec.com

Almont Lock Co. Inc.

810-798-8950

**American Auto
Accessories Inc.**

800-THE-1800, 718-458-6200
Fax: 718-458-9110
E Mail: aaanyusa@aol.com
Web: www.3aracing.com

**American
Lock Co.**

800-323-4568, 708-534-2000
Fax: 708-534-0531
Web:
www.americanlock.com

APR Industries Inc.

800-729-2674, 973-983-0880
Fax: 800-646-8721
E Mail: info@aprusa.com
Web: www.Aprusa.com

Arrow Lock Mfg. Co.

800-233-0478, 718-257-4700
Fax: 718-649-9097

ASSA

800-235-7482
718-927-2772 ext.450
Fax: 718-257-2772
Web: www.assalock.com

**Auto-Security
Products (ASP Inc.)**

425-556-1900
Fax: 425-558-1205
Web: www.carlocks.com

Baldwin Hardware Corp.

800-437-7448, 610-777-7811
 Fax: 610-775-5564

Base Industries

800-554-8088, 909-371-4465
 Fax: 909-371-2828
 E Mail: BASEBOY@EARTHLINK.NET

Baton Lock & Hardware Co. Inc.

800-395-8880, 714-265-3636
 Fax: 714-265-3630
 E Mail: batonlock@aol.com
 Web: www.batonlockusa.com

Belwith International Ltd.

800-235-9484, 616-531-4300
 Fax: 616-531-2995

BiLock North America Inc.

800-328-7030, 310-328-7030
 Fax: 310-328-7829
 E Mail: BILOCK1
 Web: www.bilock.com

Bridgeman Security Equip.

800-334-6060, 323-724-1284
 Fax: 323-727-0236

BWDAutomotive - Alabama

800-647-4926, 334-872-6526
 Fax: 334-874-6011

CalRoyal Products

800-876-9258, 323-888-6601
 Fax: 323-888-6699
 E Mail: sales@car-royal.com
 Web: www.car-royal.com

Canadian Safe Manufacturing

800-267-7635, 905-528-7233
 Fax: 905-528-7728

Cargolock

800-929-4700, 630-516-9933
 Fax: 630-516-0988
 Web: www.cargolock.com

Carlson's Lock Service

562-862-5400
 Fax: 562-949-4627

CCL Security Products

800-733-8588, 860-229-6199
 Fax: 860-223-7601
 E Mail: PRESTOLOX@AOL.COM
 Web: www.cclsecurity.com

Chicago Lock Co. One of Comx International Companies

800-445-3204, 864-297-6655
 Fax: 864-294-9987
 Web: www.nelnet.com

Computerlock Anti-Theft Devices

604-961-1280
 Fax: 604-941-4957
 E Mail: ballistic@bc.sympatico.ca
 Web: www3.bc.sympatico.ca/cyberlock

COMPX Security Products

864-297-6655
 Fax: 864-297-9987
 E Mail: INFO@NCLNET.COM
 Web: www.nclnet.com

Concord Electronic Access

888-972-6626, 718-972-5415
 Fax: 888-962-6626
 E Mail: CONCORDEL@AOL.COM

Corbin Russwin Architectural Hardware

860-225-7411
 Fax: 860-828-7266

Cordex International Ltd.

604-876-8795
 Fax: 604-876-6793
 E Mail: CORDEX@ATTCANADA.NET

Corkey Control Systems Inc.

800-622-2239, 650-692-9495
 Fax: 650-692-9410
 E Mail: corkeyus@earthlink.com
 Web: www.corkey.com

Cor-Tech Mfg. Inc.

800-649-2252, 507-283-9081
 Fax: 507-283-9081

Detex Corp.

800-729-3839, 830-629-2900
 Fax: 830-620-6711
 Web: www.detex.com

Detroit Mini-Safe Co.

800-614-0099, 313-654-8080
 Fax: 313-654-0045

Door Controls Int'l.

800-742-3634, 734-426-0400
 Fax: 800-742-0410
 E Mail: sales@doorcontrols.com
 Web: www.doorcontrols.com

Doorguard Systems Inc.

800-442-6247, 410-992-5600
 Fax: 410-992-5694
 E Mail: info@doorguardsystems.com
 Web: www.doorguardsystems.com

Manipulation Home Study Course

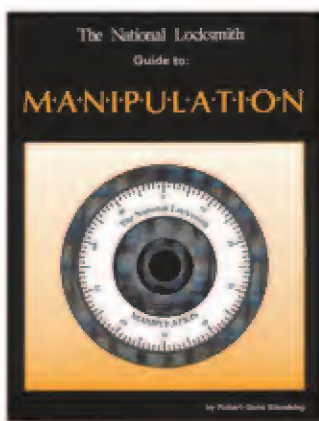

[CLICK HERE TO LEARN MORE](#)

#MAN - 1

Safe Opening Volumes 1-5



[CLICK HERE TO LEARN MORE](#)

#SO - 1, SO - 2, SO - 3, SO - 4, SO - 5

MANUFACTURERS by PRODUCT

**LOCKING
PRODUCTS
(CONTINUED)**

**Dorma Architectural
Hardware/The
DORMA Group N. A.**

800-523-8483, 717-336-3881
Fax: 717-336-2106
E Mail: archdhw@dorma-
usa.com
Web: www.dorma-usa.com

Dudley Inc.

800-363-1499, 450-247-3198
Fax: 450-247-3341
E Mail: dubbleyco@cotal.net

**Dynalock
Corporation**

877-DYNALOCK, 860-582-
4761
Fax: 860-585-0338
E Mail:
DYNALOCK.CORP@SNET.NET
Web: www.dynalock.com

EMTEK Products Inc.

800-356-2741, 818-961-0413
Fax: 800-577-5771

**Engineering Solutions
Inc**

800-995-2334, 206-241-9395
Fax: 206-241-9411
E Mail: chris@engsolinc.com
Web: www.engsolinc.com

Enixus Trade Ltd.

877-745-2715, 905-682-3086

ESP Lock Products

508-537-6121
Fax: 508-537-1699

ESSEX Industries

800-539-5377, 805-684-7601
Fax: 805-684-0232

**Eternity Security
Systems, Inc.**

800-811-3991, 732-441-7701
Fax: 732-441-0612
E Mail: sales@eternalock.com
Web: www.eternalock.com

Everswitch

973-779-8774
Fax: 973-779-8768
E Mail: alan@barantec.com
Web: www.barantec.com

Exit Security Inc.

800-446-6775, 817-429-6666
Fax: 817-831-2682

**Federal Lock
Company**

888-562-5565, 570-253-5424
Fax: 570-253-4292

**Folger Adam Security
Incorporated**

800 438 1951
Fax: 740-283-2101
E Mail:
mrobinson@yalesecurity.com

**Granite Security
Products Inc.**

817-561-9095
Fax: 817-478-3056
E Mail: BECKY@GRANITE
SAFE.COM
Web: www.graniteSafe.com

GTO Inc.

800-543-GATE, 850-575-0176
Fax: 850-575-8912
E Mail: gto@gtoinc.com
Web: www.gtoinc.com.

H.B. Ives

203-294-4837
Fax: 203-284-1460

**Hammerlock
Industries**

800-755-8345, 305-552-8345
Fax: 305-223-6097
Web:
www.HAMMERLOCK.COM

**Hampton Products
International**

800-562-5625, 949-472-4256
Fax: 949-472-9657
E Mail:
KKELLEY@HAMPTONPROD
UCTS.COM
Web:
www.hamptonproducts.com

**Hardware
Technologies Ltd.**

920-563-2626
Fax: 920-563-4408
E Mail: info@us.hoppe.com
Web: www.us.hoppe.com

**Harrison Electronic
Systems**

800-422-5050, 717-825-0540
Fax: 717-823-6343
E Mail:
hesinc@ix.netcom.com
Web: www.harrison-
hellfire.com

Hercules Industries Inc.

800-345-2590, 740-494-2628
Fax: 740-494-2274
Web: www.brass-
padlocks.com

Hudson Lock

203-353-1200
Fax: 203-348-3473

Ilco Unican

800-334-1381, 252-446-3321
Fax: 252-446-4702

**Ilco Unican Corp.
UNICAN Lock
Division**

800-849-8324, 336-725-1331
Fax: 336-725-3269
E Mail: info@win.ilcounican
Web: www.ilcounican.com

**Ilco Unican/Electronic
Access Control Div.**

800-786-9573
Fax: 973-490-3785
E Mail:
ILCO600@NETCOM.COM
Web: www.ilcounican.com

**Illinois Lock Co./Div.
of The Eastern Co**

800-733-3907, 847-537-1800
Fax: 847-537-1881
E Mail: sales@illinoislock.com
Web: www.illinoislock.com

**Info Graphic Systems
Corp.**

714-220-4980
Fax: 714-220-1828

**Intellikey
Corporation**

800-226-0703, 407-724-0700
Fax: 407-724-0811
E Mail:
INFO@INTELLIKEY.COM
Web: www.intellikey.com

**International Locking
Devices Ltd.**

800-863-9600, 203-481-6738
Fax: 203-481-8490
E Mail: ILD@TIAC.NET
Web: www.gatelock.com

**Jet Hardware
Mfg. Corp.**

718-257-9600
Fax: 718-257-0973
E Mail: Keys@jetkeys.com
Web: www.jetkeys.com

**KABA High Security
Locks**

860-621-3601
Fax: 860-621-9727

**Kenstan Lock &
Hardware Co.**

800-859-7874, 516-576-9090
Fax: 516-576-0100
E Mail:
KENSTAN@kenstan.com
Web:
www.kenstan@kenstan.com

**Key Control
Specialists**

805-538-1478
Fax: 310-640-8389

Key Systems Inc.

800-888-3553, 716-924-7830
Fax: 716-924-3515
Web: www.keystorage.com

Keysure

800-803-7308, 518-828-5337
E Mail: keysure@taconic.net
Web: www.keysure.net

**Killeen Security
Products**

800-577-5397, 508-754-1714
Fax: 508-753-2183

Knox Company

800-552-5669, 714-252-8181
Fax: 714-252-0482
E Mail: info@knoxbox.com
Web: www.knoxbox.com

Kouba & Associates Inc.

877-873-4692, 512-303-5033
Fax: 512-312-4692
E Mail: jacquie@onr.com
Web:
www.koubasystems.com

Kryptonite Corp.

800-SAY-LOCK (729-5625)
617-828-6655
Fax: 617-821-4777

**Kwikset Corporation
- A Black & Decker
Comp.**

800-327-LOCK, 949-474-8800
Fax: 949-474-879
Web: www.kwikset.com

**KXL Manufacturing
Corp.**

708-453-1788
Fax: 708-456-9476

**L&S Security
Products**

310-329-2268
Fax: 310-532-4988
E Mail:
LSSECPROD@AOL.COM
Web:
members.aol.com/lsssecprod/
index.html

La Gard Inc.

310-325-5670
Fax: 310-325-5615
E Mail:
Susan.Papa@LAGARD.COM
Web: www.LAGARD.COM

LAB Security

800-243-8242, 860-589-6037
Fax: 860-583-7838
E Mail: labpins@snet.net
Web: www.lab-lockpins.com

Latch-Gard Co. Inc.

219-862-2373
Fax: 219-862-2459

**Lexxel Lock
Mfg.**

888-972-6626, 718-972-5415
Fax: 718-972-4239
E Mail: lexxellock@aol.com

Industries Inc.

781-237-8177

Locinox USA Inc

888-711-0600, 954-714-0600
Fax: 954-749-0639

Lonchar's Inc.

215-546-4422
Fax: 215-546-5979

Lori Lock

860-621-3605
Fax: 860-621-5972
Web: www.lorilock.com

**Lund Key Control
Equipment Co.**

330-659-4800
Fax: 330-659-9347

**M.A.G. Eng. & Mfg.
Inc.**

800-624-9942, 714-891-5100
Fax: 714-892-6845
E Mail:
mageng@mindspring.com
Web: www.magsecurity.com

Magnokrom Inc.

905-671-2525
Fax: 905-671-2888
E Mail: info@magnokrom.com
Web: www.magnokrom.com

Major Manufacturing Inc.

714-772-5202
Fax: 714-772-2302
E Mail: mail@majormfg.com
Web: www.majormfg.com

Major Metalfab Inc. (MMF)

800-445-8293, 847-537-7890
Fax: 847-537-1120
E Mail: mmmfind@wwa.com
Web: www.mmmfind.com

MARKS U.S.A.

800-526-0233, 631-225-5400
Fax: 631-225-6136
E Mail: wjs@marksusa.com
Web: www.marksusa.com

Marray Enterprises Inc

800-500-1449, 408-970-0213
Fax: 408-970-8767
E Mail: ray@marray.com
Web: www.marray.com

Mas Hamilton Group Inc.

800-950-4744, 606-253-4748
Fax: 606-255-2655
E Mail: mhgmtg@mas-hamilton.com
Web: www.mas-hamilton.com

Master Lock Company

414-444-2800
Fax: 414-444-0322

Maxim Technologies Inc.

718-847-1352
Fax: 718-805-4438

Maxis Security Locks

604-434-5625
Fax: 604-434-5695
E Mail: MAXIS@DIRECT.CA

Maxton Security Systems

818-776-8557
Fax: 818-776-8558
E Mail: maxtonlocks@webtv.net

McDowell-Craig

562-921-4441
Fax: 562-921-9648

Medeco Security Locks Inc.

800-839-3157, 540-380-5000
Fax: 540-380-5010
Web: www.medeco.com

Meister Atlanta Corp.

404-451-9700
Fax: 404-451-5305

Miwa Lock Canada/ Aline Distributors

888-451-6545
Fax: 780-452-7551

Miwa Lock USA

800-397-4631, 702-454-9888
Fax: 702-454-4577
E Mail: miwalockusa@aol.com
Web: www.miwalockusa.com

Monarch Tool and Mfg. Co. Inc.

800-462-9460, 859-261-4421
Fax: 859-261-7403
E Mail: sales@monarchcoin.com
Web: www.monarchcoin.com

Moniteq Research Labs

800-989-9891, 703-569-0195
Fax: 703-569-0196

Morning Industries

909-869-0552
Fax: 909-869-5663
E Mail: morningindustries@yahoo.com
Web: www.morningindustries.com

Mosler Inc.

800-MOSLER-1, 513-870-1900
Fax: 513-870-1175
Web: www.mosler.com

Multi Lock Inc.

800-879-5645, 954-563-2148
Fax: 954-563-5644
E Mail: jford@multilock.com
Web: www.multilock.com

Multi-Lock Corporation

800-474-2220, 208-777-6543
Fax: 208-777-6402
E Mail: contact@security-multilock.com
Web: www.security-multilock.com

Mul-T-Lock USA Inc.

800-562-3511, 973-778-3222
Fax: 973-778-4007
E Mail: MTLUSA@AOL.COM
Web: www.Mul-T-Lock.com

New England Lock & Hardware Co.

203-866-9283
Fax: 203-838-4837

New Standard Mfg. Co.

702-649-0599
Fax: 702-649-0544
E Mail: newstandardmfg@mindspring.com

NU-SET LOCK

800-606-8738, 626-937-3080
Fax: 626-937-3083
E Mail: loyal@nuset.com
Web: www.nuset.com

OEM Mfg. Inc.

800-243-8636, 201-489-2184
Fax: 201-343-7315

Olympus Lock Inc.

800-525-0954, 206-362-3290
Fax: 206-362-3569
E Mail: INFO@OLYMPUS-LOCK.COM
Web: www.olympuslock.com

Omnia Industries Inc.

973-239-7272
Fax: 800-542-7611

P.E. Fraser Inc.

418-681-3214
Fax: 418-681-3352
E Mail: FRASER@MEDIOM.QC.CA
Web: www.mediom.qc.ca/~fraser

Pado Security Inc.

800-523-9877, 504-482-5318
Fax: 504-486-6509
E Mail: PADO007@AOL.COM

Papaiz U.S.A. Ltd.

800-467-7195, 713-467-7196
Fax: 713-467-7198
E Mail: PAPAIZUSA@AOL.COM
Web: www.papaizlocks.com

PC Guardian (Computer Security Products)

800-288-8126, 415-459-0190
Fax: 415-459-1162
E Mail: pcg@pcguardian.com
Web: www.pcguardian.com

PDQ Industries

800-441-9692, 717-656-4281
Fax: 717-656-6892
E Mail: PDQ@PPTNET.COM
Web: www.pptnet.com/pdq

PEMCO Mfg. Co.

800-283-9988, 805-642-2600
Fax: 805-642-4109
E Mail: SALES@PEMCO.COM
Web: www.pemco.com

Phoenix Industries Inc.

800-238-3203, 913-723-3203
Fax: 913-723-3507
E Mail: sharonc@unicom.net
Web: www.ndiyp.com

Power Access Corporation

800-344-0088, 203-693-0751
Fax: 203-693-0641
E Mail: POWACCESS@AOL.COM

Precision Hardware

734-326-7500
Fax: 734-326-7540

Preso-Matic Keyless Locks

800-269-4234, 407-324-9933
Fax: 407-328-9977
E Mail: campbell@parkave.net

Prestolock by CCL Security Products

800-216-0082, 203-229-6199
Fax: 203-223-7601
E Mail: PRESTOLOX@AOL.COM

Prime-Line Products Co.

800-255-3505, 909-887-8118
Fax: 909-880-8968
E Mail: JFRI@PLP.mhs.COMPUSEVERE.com

PRO-LOK

714-633-0681
Fax: 714-633-0470

RCI Rutherford Controls International Corp.

800-899-5625, 757-427-1230
Fax: 757-427-9549
E Mail: sales@rutherfordUSA.com
Web: www.rutherfordcontrols.com

Reading Industries

888-428-4593
610-374-0776 x 3054
Fax: 610-374-9088

S. Parker Hardware Mfg. Corp.

800-S-PARKER, 201-569-1600
Fax: 201-569-1082
E Mail: HARDWARE@SPARKER.COM
Web: www.Sparker.com

Saf T Lok

800-723-8565, 561-743-5625
Fax: 561-745-6601
Web: www.saf-t-lok.com

Safe-O-Mat Deposit Locks

612-921-3315
Fax: 800-733-7139
E Mail: safeomat@yorktownoffices.com
Web: www.safeomat.com

SAFLOK

800-LOCKS-33 OR 562-5733
714-722-5400
Fax: 714-722-0129
E Mail: PHIL@CSSMAIN.COM
Web: www.winfieldlock.com

Salsbury Industries

800-323-3003, 323-846-6700
Fax: 323-846-6800
E Mail: mailboxes@salsbury.com
Web: salsbury.com

Sandstrom Products Co.

800-747-1084, 309-523-2121
Fax: 309-523-3912
Web: www.sandstromproducts.com

LOCKING PRODUCTS (CONTINUED)

Sargent & Greenleaf Inc.

800-826-7652, 859-885-9411
Fax: 859-887-2057
E Mail: custsvc@sglocks.com
Web: sglocks.com

Sargent Manufacturing Co.

800-727-5477, 203-562-2151
Fax: 888-863-5054
E Mail: webmaster@sargentlock.com
Web: www.sargentlock.com

SECO-LARM USA INC.

800-662-0800, 949-261-2999
Fax: 949-261-7326
E Mail: info@seco-larm.com
Web: www.seco-larm.com

Securitech Group Inc.

800-625-LOCK, 718-392-9000
Fax: 718-392-8944
E Mail: SECURITEC@AOL.COM
Web: www.securitech.com

Securitron Magnalock Corp.

800-MAG-LOCK, 775-355-5625
Fax: 775-355-5636
E Mail: INFO@SECURITRON.COM
Web: www.securitron.com

Security Distributors Incorporated

214-879-15555
Fax: 214-879-1525
Web: www.uscanlock.com

Security Door Controls

805-494-0622
Fax: 805-494-8680
E Mail: service@sdsecurity.com
Web: www.sdsecurity.com

Security Latch

800-633-6622, 906-484-3120
Fax: 906-484-2761
E Mail: seclat@sault.com
Web: www.securitylatch.com

Sentinel Diversified Industries, Inc.

880-526-9000, 631-753-6000
Fax: 631-753-6104
E Mail: pete@sentineldiversified.com
Web: www.l-sdi.com

Sentrylok Corp.

800-883-1116, 330-425-1354
Fax: 330-425-1884
E Mail: info@sentrylok.com
Web: www.sentrylok.com

Slideline Inc.

760-945-0544
Fax: 760-945-8359

Slydelock

800-664-5625, 819-770-1020
Fax: 819-771-5295
E Mail: marketing@slydelock.com
Web: www.slydelock.com

STAT Lock

800-286-7412, 610-872-7446
Fax: 610-872-6378

Steadfast Corporation

800-342-5911, 617-889-3400
Fax: 617-889-2424
E Mail: STEADFAS@TIAC.NET

Strattec Security Corp.

414-247-3333
Fax: 414-247-3329

Suncoast Security Inc.

800-441-2218, 727-530-7768
Fax: 727-585-2859
E Mail: suncoastlocks@cs.com

Sunroc Telkee

302-678-7800
Fax: 302-678-7809
E Mail: telkee@sunroc.com
Web: www.telkee.com

Supra Products

800-547-0252, 503-581-9101
Fax: 503-364-1285
Web: www.supra-products.com

Tanner Bolt & Nut Corp.

800-456-2658, 718-434-4500
Fax: 718-434-3215
E Mail: info@tannerbolt.com
Web: www.tannerbolt.com

TESA Inc.

800-472-8372

Timberline Lock Ltd.

800-562-5227, 847-234-1864
Fax: 847-234-7922
E Mail: sales@timberlinelock.com
Web: www.timberlinelock.com

Trans-Atlantic Company

800-523-9956, 215-629-0400
Fax: 800-531-0844
E Mail: tacoj@aol.com
Web: www.transatlantic.com

Trimec

800-987-4632
Fax: 404-871-1870
E Mail: sales@trimec-usa.com
Web: www.trimec-usa.com

Trine Access Technology

718-829-6405
Fax: 718-829-6405
E Mail: customerservice@trineonline.com
Web: www.trineonline.com

Tri-Star Products (Door Armor)

310-325-8016, Fax: 310-325-8016

Tufloc

800-321-0870, 330-452-9132
Fax: 330-452-2557
Web: www.esmet.com

Tufloc Mfg. by Esmet

800-321-0870, 330-452-9132
Fax: 330-452-2557
E Mail: info@esmet.com
Web: www.ESMET.com

U-Change Lock Industries Inc.

800-253-5625, 405-376-1600
Fax: 405-376-6870
E Mail: REKEY@U-CHANGE.COM
Web: www.u-change.com

Ultra Hardware Products

800-426-6379, 609-663-5050
Fax: 800-858-7210

Videx

541-758-0521
Fax: 541-752-5285
E Mail: sales@videx.com
Web: www.videx.com

Vigilante Burglar Bars Inc.

718-328-3700
Fax: 718-893-7168
E Mail: vigillock@aol.com
Web: www.vigillock.com

Visonic Inc.

800-223-0020, 860-243-0833
Fax: 860-242-8094
E Mail: info-usa@visonic.com
Web: www.visonic.com

Weslock National Inc.

800-575-BOLT (2658)
310-327-2770
Fax: 310-324-4624

W-LOK

877-355-WLOK, 616-355-4015
Fax: 616-355-4295
E Mail: office@wlokcorp.com
Web: www.wlokcorp.com

XL Lock Mfg.

805-499-9727
Fax: 805-499-8208
E Mail: info@xllock.com
Web: www.xllock.com

Yale Div. of Yale Security Inc.

800-438-1951, 704-283-2101
Fax: 704-289-2875

Yortec Inc.

909-595-8512
Fax: 909-468-2685
E Mail: sales@yortec.com
Web: www.yortec.com

LOCKSMITH TOOLS & EQUIPMENT

A&B Manufacturing Co. Inc.

860-628-5030

A-I Security Mfg. Corp.

877-725-2121, 804-359-9003
Fax: 804-359-9415
E Mail: FMCC@demanda1.COM

Aable Locksmiths

718-847-1377
Fax: 718-847-0991

ABC Lock Co.

402-598-5298

Abus Lock Co.

800-352-2287, 612-509-9933
Fax: 612-509-9939
E Mail: 74511.1570@COMPUSERVE.COM
Web: www.abus.com

Accu-Lock Inc.

817-447-4085
Fax: 817-447-6534
E Mail: Rick@acculock.com
Web: www.acculock.com

Adapt-A-Bore

800-829-8905, 414-291-5684
Fax: 414-291-5685
E Mail: aspurich@execpc.com
Web: www.doorhardware.net

Adrian Steel Co.

800-677-2776, 517-265-6194
Fax: 517-265-5834
Web: www.adriansteel.com

Advance Car Mover Company

800-571-0136, 920-386-4464
Fax: 920-386-4416

Aero Lock

800-627-9433, 901-368-2147
Fax: 901-362-1197
E Mail: AEROLOCK@IX.NETCOM.COM
Web: www.aerolock.com

All-Safe Security Systems Ltd.

403-212-5660
Fax: 403-259-5110
E Mail: allsafe@allsafesec.com
Web: www.allsafesec.com

Almont Lock Co. Inc.

810-798-8950

America Key Boxes

800-561-5397, 817-561-5397
Fax: 817-561-2881
E Mail: KEYBOX@FLASH.NET
Web: www.keyboxes.com

American Tolkey & Die

888-695-8365, 407-327-2012
 Fax: 407-327-2074
 E Mail: amtolkey@bellsouth.net
 Web: www.tolkey.com

Amoratech Inc.

880-233-6126, 717-582-3819
 Fax: 717-582-7549
 E Mail: less@amoratech.com
 Web: www.balliston-lube.com

Auto-Security Products (ASP Inc.)

425-556-1900
 Fax: 425-558-1205
 Web: www.carlocks.com

Baton Lock & Hardware Co. Inc.

800-395-8880, 714-265-3636
 Fax: 714-265-3630
 E Mail: batonlock@aol.com
 Web: www.batonlockusa.com

Blackhawk Products

970-882-7191
 Fax: 970-882-7228
 E Mail: staff2blackhawk7.com
 Web: www.blackhawk7.com

Boggs Tool Processing & File Sharpening Co.

800-547-5244 outside CA
 562-634-1081
 Fax: 562-634-0839
 E Mail: C.BOGGS1@AOL.COM
 Web: www.BoggsTool.com

BWDAutomotive - Alabama

800-647-4926, 334-872-6526
 Fax: 334-874-6011

Car Openers Inc., The

800-561-0443, 407-884-5689

Commercial Van Interiors

800-759-7477, 314-423-7477
 Fax: 314-427-1525

Computer Reset

214-348-6484
 Fax: 214-343-3150
 E Mail: sales@c-reset.com
 Web: www.c-reset.com

Continental Micro Inc.

847-692-3630
 Fax: 847-318-6188

Corbin Russwin Architectural Hardware

860-225-7411
 Fax: 860-828-7266

Darex Corp.

800-547-0222, 541-488-2224
 Fax: 541-488-2229
 E Mail: kari@darex.com
 Web: www.darex.com

Don-Jo Manufacturing

800-628-8389, 978-422-3377
 Fax: 978-422-3467
 E Mail: DON-JO@DON-JO.COM

Dremel

414-554-1390
 Fax: 414-554-7654

ESP Lock Products

508-537-6121
 Fax: 508-537-1699

Fort Lock Corp.

708-456-1100
 Fax: 708-456-9476
 E Mail: info@fortlock.com
 Web: www.fortlock.com

Framon Manufacturing Company Inc.

517-354-5623
 Fax: 517-354-4238
 E Mail: FRAMON@NORTHLAND.LIB.MI.US
 Web: www.framon.com

Gator Tools

719-591-8343
 Fax: 719-550-0953
 E Mail: duxpond@sprynet.com
 Web: www.aduxpond.com

Gil-Ray Tools Inc.

517-892-6870
 Fax: 517-892-6870
 E Mail: djdeuel@bigfoot.com
 Web: www.angelfire.com/biz/GilRayToolsInc/

GT-85 International Inc.

800-525-GT85, 813-522-7785
 Fax: 813-526-1234

Henry A. Evers Corp.

800-553-8377 800-55-EVERS
 401-781-4767
 Fax: 401-781-9581
 E Mail: everstamp@aol.com
 Web: www.henryevers.com

High Tech Tools

800-323-8324, 305-649-7014
 Fax: 305-541-0074
 E Mail: sales@hightechtools.com
 Web: www.hightechtools.com

Hill Security Products

800-722-1142, 509-487-1142
 Fax: 509-487-3166

HPC Inc.

800-323-3295, 847-671-6280
 Fax: 847-671-6343
 E Mail: HPC@HPCWORLD.COM
 Web: www.hpcworld.com

Ilco Unican

800-334-1381, 252-446-3321
 Fax: 252-446-4702

InstaCode 200 I

630-837-2044
 Fax: 630-837-1210
 E Mail: natllock@aol.com
 Web: www.TheNationalLocksmith.com

Intralock Tools Ltd.

888-264-6627, 604-852-8904
 Fax: 604-852-8938
 E Mail: sales@intralock.bc.ca
 Web: www.intralocktools.com

Jensen Tools Inc.

800-426-1194, 602-453-3169
 Fax: 800-366-9662
 E Mail: jensen@stanleyworks.com
 Web: www.jensentools.com

Kaddies Inc.

800-523-KADDIES, 925-934-4488
 Fax: 925-934-4492
 E Mail: tshettle@pacbell.net
 Web: www.kaddiesinc.com

Keedex Inc.

714-636-5657
 Fax: 714-636-5680
 E Mail: INFO@KEEDEX.COM
 Web: www.keedex.com

Keefe Lock Co.

609-882-2290
 Fax: 609-882-1698

Kent-Moore

800-345-2233, 810-578-7218
 Fax: 800-578-7375

KEY-BAK; Div. of West Coast Chain Mfg. Co.

800-685-2403, 09-923-7800
 Fax: 800-565-6202
 E Mail: sales@keybak.com
 Web: www.keybak.com

KeySoft Masterkeying Software

800-505-6636, 801-521-0869
 E Mail: KEYSOFT@BURGOYNE.COM
 Web: www.masterkeypro.com

Knaack Mfg. Co.

800-456-7865, 815-459-6020
 Fax: 815-459-9097
 E Mail: info@knaack.com
 Web: www.weatherguard.com

Kustom Key Inc.

800-537-5397, 520-453-8338
 Fax: 800-235-4728
 E Mail: SALES@KUSTOMKEY.COM
 Web: www.kustomkey.com

LAB Security

800-243-8242, 860-589-6037
 Fax: 860-583-7838
 E Mail: labpins@snet.net
 Web: www.lab-lockpins.com

Ladyfayre Holdings LTD

800-579-0737, 403-258-2588
 Fax: 403-640-4215
 E Mail: ladyfayre@ultralink.com

LeRoy Edenburn Enterprises

734-483-2444
 Fax: 734-485-8769

The Ultimate Technitips Collection



Here's one of the most useful books ever available to the locksmith!

CLICK HERE TO LEARN MORE



#TIPS - 2

MANUFACTURERS by PRODUCT

LOCKSMITH TOOLS & EQUIPMENT (CONTINUED)

Lindustries Inc.

781-237-8177

Lisle Corp.

712-542-5101
Fax: 712-542-6591

Lock Technology Inc.

800-421-7241, 630-369-6060
Fax: 630-983-5967

Locksoft Inc.

402-461-4149
Fax: 402-461-4359
E Mail: ls24242.navix.net
Web: www.locksoft.com

Lucky Line Products Inc.

800-654-6409, 858-549-6699
Fax: 858-549-0949
E Mail:
JPenaskovic@Luckyline.com
Web: www.luckyline.com

M.K. Morse Company

800-733-3377, 330-453-8187
Fax: 800-729-1112 or 330-453-1111

E Mail:
MKMORSE@MKMORSE.COM
Web: www.MKMORSE.COM

Major Manufacturing Inc.

714-772-5202
Fax: 714-772-2302
E Mail: mail@majormfg.com
Web: www.majormfg.com

Major Metalfab Inc. (MMF)

800-445-8293, 847-537-7890
Fax: 847-537-1120
E Mail: mmmfind@wwa.com
Web: www.mmmfind.com

Marray Enterprises Inc

800-500-1449, 408-970-0213
Fax: 408-970-8767
E Mail: ray@marray.com
Web: www.marray.com

MDS (Medical Diagnostics Services Inc.)

800-435-9352, 813-653-1180
Fax: 813-684-5953
E Mail: mdsinc@gte.com
Web:
www.medsincorporated.com

National Locksmith, The

630-837-2044
Fax: 630-837-1210
E Mail: natllock@aol.com
Web:
www.TheNationalLocksmith.com

Next Generation Tool Co.

800-874-LOCK (5625)
915-698-3094
Fax: 915-698-7622
E Mail: ntxtgentool@aol.com
Web: www.nextgentool.com

Numberall Stamp & Tool Co. Inc.

207-876-3541
Fax: 207-876-3566
E Mail:
www.office@numberall.com
Web: www.numberall.com

OEM Mfg. Inc.

800-243-8636, 201-489-2184
Fax: 201-343-7315

Pado Security Inc.

800-523-9877, 504-482-5318
Fax: 504-486-6509
E Mail: PADO
007@AOL.COM

Paktek Inc.

800-258-8458, 253-584-4914
Fax: 253-589-1091
E Mail: paktek@prodigy.com
Web: www.toolpak.com

Panef Corp.

800-448-1247, 414-464-7200
Fax: 414-462-0980

Peterson Manufacturing

716-264-1199
Fax: 716-586-0425

PowerStar Products Inc.

408-774-6800
Fax: 408-774-6818

PRO-LOK

714-633-0681
Fax: 714-633-0470

R.J. Stuckel Co. Inc.

800-789-7220, 847-593-7220
Fax: 847-593-6027

Reading Body Works

800-458-2226, 610-775-3301
Fax: 610-775-3261
E Mail:
marketng@readingbody.com
Web: www.readingbody.com

Roto Zip Tool Corp.

800-521-1817, 608-798-3737
Fax: 608-798-3739
Web: www.rotozip.com

RQ Associates

734-671-2359
Fax: 734-671-2359
E Mail: quinn@ili.net

Rytan Inc.

800-447-9826, 310-328-6553
Fax: 310-212-6002
E Mail: runplastic@aol.com
Web: www.rytan.com

Schlage Commerical Lock Division

800-847-1864, 719-264-5300
Fax: 719-264-5382
Web: www.schlage.com

Schwenk Lock

408-978-0403
Fax: 408-247-5397
E Mail: schwenkco@col.com
Web: www.schwenkco.com

Security Distributors Incorporated

214-879-1555
Fax: 214-879-1525
Web: www.uscanlock.com

Security Fastener Co.

707-746-8025
Fax: 707-746-0347

Sieveking Products Co.

815-874-4030
Fax: 815-874-5713
E Mail:
sievekingprodco@sievekingpr
odco.com
Web:
www.sievekingprodco.com

Slide Lock Tool Co. Inc., Z Tool Div.

800-336-8812, 423-577-8470
Fax: 423-577-5936

Specialty Products Mfg. LLC

860-621-6969
Fax: 860-620-9372

Steck Mfg. Co. Inc.

800-227-8325, 937-222-0062
Fax: 937-222-6666
E Mail:
steckmfgco@earthlink.net

Strattec Security Corp.

414-247-3333
Fax: 414-247-3329

Streamlight Inc.

800-523-7488, 610-631-0600
Fax: 610-631-0712
Web: www.streamlight.com

StrongArm Safe Drills & Rigs

800-710-8168, 650-952-7710
Fax: 650-794-0541
E Mail: jvdrills@aol.com

Synco Chemical Corp

800-253-5823, 631-567-5300
Fax: 631-5675359
E Mail: info@super-lube.com
Web: www.super-lube.com

Tanner Bolt & Nut Corp.

800-456-2658, 718-434-4500
Fax: 718-434-3215
E Mail: info@tannerbolt.com
Web: www.tannerbolt.com

Tech-Train Productions

800-356-0136, 850-476-7197
Fax: 850-476-7410
E Mail: techtrain@techtrain
productions.com
Web: www.TECHTRAIN
PRODUCTIONS.COM

Thorvie International

920-497-0572
Web: www.Thorvie.com

Timemaster Inc.

888-798-8464
Fax: 800-798-TIME
E Mail: timstr@aol.com
Web: www.time-master.com

Tripp Lite

773-869-1111
Fax: 773-869-1329
E Mail:
INFO%TRIPPLITE@MCIMAIL
.COM
Web: www.triplite.com

Truecraft Tools

800-532-8665, 732-805-7800
Fax: 732-805-9736
E Mail:
info@truecrafttools.com
Web: www.truecrafttools.com

Vern Rose Tool

858-695-3384
Fax: 858-695-3387

WD-40 Co.

619-275-1400
Fax: 619-275-5823
Web: www.wd40.com

Young Bros. Stamp Works

800-553-8248, 319-263-3575
Fax: 319-263-8003
Web:
www.youngbrosstampworks
.com

SAFES & SAFE PRODUCTS

A&B Safe Corp.

800-253-1267, 856-863-1186
Fax: 856-863-1208
E Mail: INFO@A-
BSAFECORP.COM
Web: www.A-
BSAFECORP.COM

Accu-Lock Inc.

817-447-4085
Fax: 817-447-6534
E Mail: Rick@acculock.com
Web: www.acculock.com

Adesco Safe Mfg. Co.

800-821-6803, 562-630-1503
Fax: 562-408-6427
E Mail: sales@adesco.com
Web: www.adesco.com

All Secure & Safe Service

888-815-3566, 708-423-2303
E Mail: allseckarl@msn.com

All-Safe Security Systems Ltd.

403-212-5660
Fax: 403-259-5110
E Mail: allsafe@allsafesec.com
Web: www.allsafesec.com

SAFES & SAFE PRODUCTS (CONTINUED)

American Security Products Co.

800-421-6142, 909-685-9680
Fax: 909-685-9685
E Mail: sec@amsecusa.com
Web: www.amsecusa.com

Amoratech Inc.

880-233-6126, 717-582-3819
Fax: 717-582-7549
E Mail: less@amoratech.com
Web: www.balliston-lube.com

Armor Safe Technologies

800-487-2766, 619-598-5470
Fax: 619-598-5471
E Mail: armorsafe@ixpres.com

Bob Murray Safe & Vault Co.

516-377-1760
Fax: 516-377-1760
E Mail: bobmurray@yahoo.com

Bridgeman Security Equip.

800-334-6060, 323-724-1284
Fax: 323-727-0236

Buddy Products Locksmith Division

800-886-8688, 312-733-6400
Fax: 312-733-8356
E Mail: sdifiglio@att.net
Web: www.buddyontheweb.com

Canadian Safe Manufacturing

800-267-7635, 905-528-7233
Fax: 905-528-7728

Cannon Safe Inc.

800-242-1055, 562-692-0636
Fax: 562-692-7252
E Mail: mbaker@cannonsafe.com
Web: www.CANNONSAFE.COM

Cobalt Manufacturing Division of Meilink

877-824-1449, 940-240-1449
Fax: 940-464-1010
E Mail: watkinsc@gte.net

Dayton Safe Company

800-337-9637, 937-461-3900
Fax: 937-461-4044
E Mail: daysafe@aol.com

Decoy Safe Co.

800-972-1850, 407-295-1288
Fax: 407-295-1202
E Mail: PCURTIS@DSC.NET
Web: decoysafe.com

Detroit Mini-Safe Co.

800-614-0099, 313-654-8080
Fax: 313-654-0045

Escalera Inc.

800-622-1359, 530-673-6318
Fax: 530-673-6376
E Mail: info@escalera.com
Web: www.escalera.com

Fort Knox Security Products

800-821-5216, 801-224-7233
Fax: 801-226-5493
Web: www.ftknox.com

Gardall Safe Corp.

800-722-7233, 315-432-9115
Fax: 315-434-9422
E Mail: mkoesteres@gardall.com
Web: www.gardall.com

Graffunder

541-962-7233
Fax: 541-962-0913
E Mail: grafsafe@eoni.com
Web: www.eoni.com/~grfsafe

Granite Security Products Inc.

817-561-9095
Fax: 817-478-3056
E Mail: BECKY@GRANITE SAFE.COM
Web: www.graniteSafe.com

Gun Vault

623-445-0309
Fax: 623-445-0310
Web: www.gunvault.com

Hayman Safe Co. Inc.

800-444-5434, 407-365-5434
Fax: 407-365-8958
E Mail: INFO@ HAYMANSAFE.COM
Web: www.haymansafe.com

Horizon Safe Manufacturing Inc.

800-320-3257, 562-698-0789
Fax: 562-945-4846

HPC Inc.

800-323-3295, 847-671-6280
Fax: 847-671-6343
E Mail: HPC@HPCWORLD.COM
Web: www.hpcworld.com

Ilco Unican

800-334-1381, 252-446-3321
Fax: 252-446-4702

In-A-Floor Safe Co.

800-437-9116, 805-493-9116
Fax: 805-493-0568
E Mail: inafloorsafe@juno.com

Indiana Cash Drawer Co.

800-227-4379, 317-398-6643
Fax: 317-392-0958
E Mail: cshergi@icdpos.com
Web: www.icdpos.com

Innovative Moving Systems Inc.

800-619-0625, 920-564-6272
Fax: 920-564-2322
Web: www.lectrotruck.com

Keedex Inc.

714-636-5657
Fax: 714-636-5680
E Mail: INFO@KEEDEX.COM
Web: www.keedex.com

Key Systems Inc.

800-888-3553, 716-924-7830
Fax: 716-924-3515
Web: www.keystorage.com

Knight Safe Mfg.

800-872-2458, 909-982-9653
Fax: 909-982-0529
E Mail: knightsafemfg@aol.com
Web: www.knightsafemfg.com

Knox Company

800-552-5669, 714-252-8181
Fax: 714-252-0482
E Mail: info@knoxbox.com
Web: www.knoxbox.com

La Gard Inc.

310-325-5670
Fax: 310-325-5615
E Mail: Susan.Papa@LAGARD.COM
Web: www.LAGARD.COM

Liberty Safe & Security Products Inc.

800-247-5625, 801-489-8550
Fax: 801-489-6409
Web: www.libertysafe.com

Lifetime Products

800-369-5365, 309-853-3387
Fax: 309-853-3389
E Mail: tamco@inw.net
Web: www.lift-a-load.com

McGunn Safe Co. L.L.C.

800-621-2816, 773-884-3560
Fax: 773-884-6560
E Mail: alanh@mcgunnsafe.com
Web: www.mcgunnsafe.com

Meilink Safe Co.

800-634-5465, 812-941-0024
Fax: 800-896-6606
E Mail: meilink@meilinksafes.com
Web: www.meilinksafes.com

Mosler Inc.

800-MOSLER-1, 513-870-1900
Fax: 513-870-1175
Web: www.mosler.com

National Locksmith, The

630-837-2044
Fax: 630-837-1210
E Mail: natllock@aol.com
Web: www.TheNationalLocksmith.com

National Safeman's Organization

630-837-2044
Fax: 630-837-1210
E Mail: natllock@aol.com
Web: www.TheNationalLocksmith.com

National Security Safe Co.

800-544-3829, 801-756-7706
Fax: 801-756-8043

NKL Industries

800-528-9900, 757-485-0200
Fax: 757-485-0271

P.E. Fraser Inc.

418-681-3214
Fax: 418-681-3352
E Mail: FRASER@MEDIOM.QC.CA
Web: www.mediom.qc.ca/~fraser

Pacific Security Products Co.

800-331-0785, 626-570-4655
Fax: 626-289-2326

Palmer Security Products Inc.

800-788-7725, 773-267-4855
Fax: 773-267-8080
E Mail: info@palmersecurity.com
Web: www.palmersecurity.com

Perma Vault Safe Corp.

800-662-3360, 215-938-4300
Fax: 215-938-4310
E Mail: SALES@PERMA-VAULT.COM
Web: www.PERMA-VAULT.COM

PRO-LOK

714-633-0681
Fax: 714-633-0470

Reading Industries

888-428-4593
610-374-0776 x 3054
Fax: 610-374-9088

RQ Associates

734-671-2359
Fax: 734-671-2359
E Mail: quinn@ili.net

SAFLOK

800-LOCKS-33 OR 562-5733
714-722-5400
Fax: 714-722-0129
E Mail: PHIL@CSSMAIN.COM
Web: www.winfieldlock.com

Schwab Corp.

800-428-7678, 765-447-9470
Fax: 765-447-8278
E Mail: schwab@schwabcorp.com
Web: www.schwabcorp.com

**Securex Americas
 Div. Of Incas Safe
 Corp.**

800-813-8462, 905-660-3025
 Fax: 905-660-8823
 E Mail: barry@inkas.ca
 Web: www.inkas.com

**Security Distributors
 Incorporated**

214-879-15555
 Fax: 214-879-1525
 Web: www.uscanlock.com

Sentry Group

800-828-1438, 716-381-4900
 Fax: 716-381-8559
 E Mail:
 k_brosius@sentrysafe.com
 Web: www.sentrysafe.com

Skarnes Inc.

800-752-7637, 612-339-9141
 Fax: 612-339-5749
 E Mail: skarnes@mn.state.net

**StrongArm
 Safe Drills &
 Rigs**

800-710-8168, 650-952-7710
 Fax: 650-794-0541
 E Mail: jvdrills@aol.com

**Subterranean Data
 Storage**

208-746-2188
 Fax: 208-743-2799
 E Mail: sdsco@sdsvaults.com
 Web: www.sdsvaults.com

TESA Inc.

800-472-8372

Timemaster Inc.

888-798-8464
 Fax: 800-798-TIME
 E Mail: timstr@aol.com
 Web: www.time-master.com

Tufloc

800-321-0870, 330-452-9132
 Fax: 330-452-2557
 Web: www.esmet.com

**U-Change Lock
 Industries Inc.**

800-253-5625, 405-376-1600
 Fax: 405-376-6870
 E Mail: REKEY@U-
 CHANGE.COM
 Web: www.u-change.com

Walvaults Inc.

800-528-4089, 702-222-1030
 Fax: 702-736-6169
 E Mail: Sales@rsfab.com
 Web: www.rsfab.com

Wilson Safe Co.

800-345-8053, 215-492-7100
 Fax: 215-492-7104
 E Mail:
 WILSONSAFE@AOL.COM
 Web: www.wilsonsafe.thomas
 register.com



**Dave McOmie
 on Safe Locks**

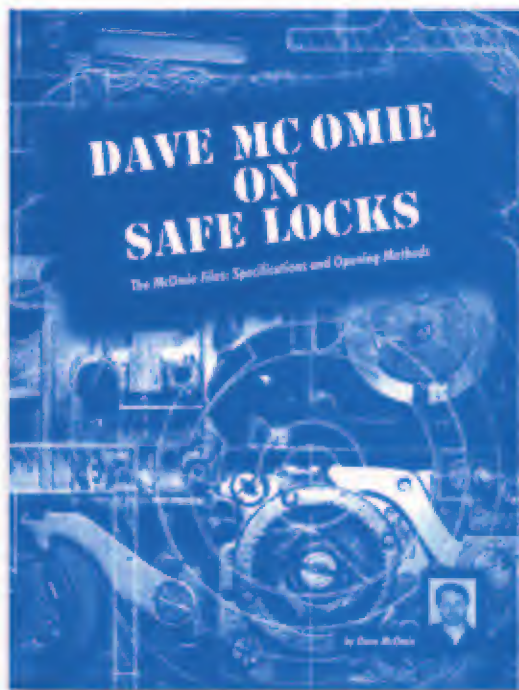

Almost 300 pages of information, photographs and illustrations give you every scrap of information about a huge variety of safe locks.

[CLICK HERE TO LEARN MORE](#)



#DMSL - 1

**Safe Opening
 Articles**

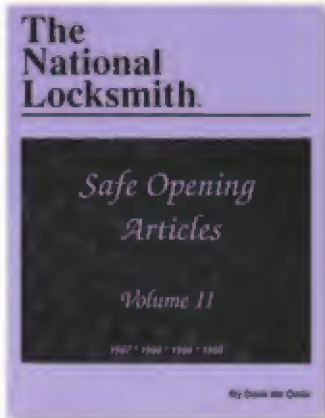

Dave McOmie's original articles from when he first started writing for The National Locksmith are reprinted in this book.

[CLICK HERE TO LEARN MORE](#)



#SA - 2

MANUFACTURERS by PRODUCT

DISTRIBUTORS

DISTRIBUTORS

Access Hardware Supply

14359 Catalina St.
 San Leandro, CA 94577
 800-348-2263, 510-483-5000
 Fax: 800-435-8233
 E Mail: JREAM@LOCKS.com
 Web: www.ACCESSHARDWARE.com
 Rich Harsha Sales Coordinator
 Scott Rogers, John Ream VP
Product Categories: A B E F

Access Safe & Supply Ltd.

6300 Dixie Rd.
 Mississauga Ont., Canada L5T 1A7
 800-268-9033, 905-795-9802
 Fax: 905-795-9804
 Peter K. Gauthier Pres., Linda Gauthier
Product Categories: C D F G H
 See ad on page 75

Accredited Lock Supply Co.

1161 Paterson Plank Road
 Secaucus, NJ 07094
 800-652-2835, 201-865-5015
 Fax: 201-865-5031
 E Mail: mail@acclock.com
 Web: www.acclock.com
 Ron Weaver Pres., Rich Chakov GM
 Eric Hagee Sales Mgr.
Product Categories: A B D E F G H

Ace Lock The Security People

5964 Baum Square
 Pittsburgh, PA 15206
 800-824-7712, 412-363-3328
 Fax: 412-363-7540
 E Mail: info@acelockinc.com
 Sandra Hunter Pres.
 Larry Sheets Oper. Mgr.
 James Jewell Treasurer
Product Categories: A B E F G H

Ace Lock & Security Supply

565 Rahway Ave.
 Union, NJ 07083
 800-223-5625, 908-688-7666
 Fax: 908-688-2442
 E Mail: ACELOCK@ACELOCK.COM
 Web: www.ACELOCK.COM
 Daniel Goldstein Pres., Robin Cherkes VP
 Stan Gabay Dir. Sales & Mktg.
Product Categories: A B D E F G H
 See ad on page 81

ADI

165 Eileen Way
 Syosset, NY 11791
 516-921-6704
 Fax: 516-921-8118
 Leo A. Guthart Chair.

Agences W. Pelletier (I980) Inc.

440 Beaumont
 Montreal Quebec, Canada H3N 1T7
 800-363-6700, 514-276-6700
 Fax: 514-276-9413
 E Mail: sales@apa-pelletier.com
 Web: www.apa-pelletier.com
 A. Cheply GM
 B. Sanssouci Sales & Mktg. Mgr.
Product Categories: A B C D E F G H
 Branches: Agences R. Cantin Inc.
 Quebec Canada
 418-681-7522, 418-681-1075

Akron Hardware Consultants

1100 Killian Rd.
 Akron, OH 44312
 800-321-9602, 330-644-7167
 Fax: 800-328-6070
 Web: www.akronhardware.com
 Kenneth E. Orihel, Bill Jubara
 Barryl Thompson
Product Categories: B F E
 Branches: Gilbert AZ
 Tim Kane
 800-457-9378 FAX 800-457-8773

Alarm Systems Distributors

883 Broadway
 Albany, NY 12207
 518-463-4000
 Fax: 518-463-4628
 Peter Cosgrave

Allied Locksmith Supply

P.O. Box 3137
 Youngstown, OH 44513-3137
 800-544-2102, 330-726-0866
 Fax: 330-726-0865
 E Mail: wiesnercorp@msn.com
 Rudy R. Wiesner Pres.
 Jim Dravec Oper. Mgr.
 Bill Stark Sales Mgr.
Product Categories: C D F G

Ambassador Wholesale Safe Distributors

21 North Beverwyck Rd.
 Lake Hiawatha, NJ 07034
 800-999-5510, 973-263-3768
 Fax: 973-402-1447
 Jeff Hale Pres.
Product Categories: H

American Lock & Key Co.

2110 Spencer Rd.
 Richmond, VA 23230
 800-995-6247, 804-282-6060
 Fax: 804-282-1007
 Barry Wilson
 Harry Wilson Treas.
Product Categories: B E F H

AmoraTech Inc.

P.O. Box 100
 Shermans Dale, PA 17090
 717-582-3819
 Fax: 717-582-7549
 Web: www.ballistol-lube.com
 Les Moyer
Product Categories: G

Amos Lock & Key Supply Co.

2711 Cullen St.
 Fort Worth, TX 76107
 800-772-7432, 317-335-5397
 Fax: 317-335-5399
 Amos Strange Pres.
Product Categories: B F G H

Anchor Safe Co.

2627 E. 8 Mile Rd.
 Warren, MI 48091
 800-541-8050, 810-755-3570
 Fax: 810-755-1760
 John Szechowycz VP
 Orest Kalba Pres.
Product Categories: H
 Branches: Madison Hts. MI

Anderson Lock Co.

850 Oakton St.
 Des Plaines, IL 60018
 800-323-5625, 847-296-1157
 Fax: 847-296-9259
 E Mail: mail@andersonlock.com
 Web: www.andersonlock.com
 Eugene R. Anderson Pres.
 Norm Anderson VP
Product Categories: B C E F G H

Andrew's Wholesale Lock Supply

544 South 9th St.
 Lebanon, PA 17042
 800-544-0519, 717-274-8733
 Fax: 717-274-8659
 Web: www.andrewslock.com
 Richard A. Rudy Owner, Pat Kreiser
Product Categories: F

ASLA Distributing

PO Box 5138
 Clinton, NJ 08809
 516-766-2863, Fax: 516-766-2863
 E Mail: dean@asla-distributing.com
 Web: www.asla-distributing.com
 Arnold Dean
Product Categories: B F
 See ad on page 47

Associated Lock & Supply

2526 Davies Ave.
 Port Coquitlam BC, Canada V3C 4T7
 800-668-7161, 604-942-5625
 Fax: 604-942-3761
 Greg Smith Sr. Pres.
Product Categories: D E F G H

Atlantic Lock & Key

P.O. Box 85145
 Hallandale, FL 33020
 954-966-9862
 Fax: 954-962-1202
 Steve Blaustein

Automatic Gate Wholesalers

P.O. Box 5344
 Redwood City, CA 94063-5344
 800-238-2301, 650-365-4340
 Fax: 800-438-2301
 Steve SanFilippo VP, Tony Hird Office
 Mgr./Sales
 Lynda Mull Mktg./Sales
Product Categories: E F

AutoSmart Advisor

1533 Burgundy Parkway
 Streamwood, IL 60107
 630-837-2044
 Fax: 630-837-1210
 E Mail: natllock@aol.com
 Web: www.AutoSmartAdvisor.com
 Michael Hyde, Marc Goldberg
Product Categories: D

PRODUCT CATEGORY KEY

- A — Alarms
- B — Architectural Hardware
- C — Training Manuals & Materials
- D — Locksmith Software
- E — Electronic Security Products
- F — Locking Products
- G — Locksmith Tools & Equipment
- H — Safes & Safe Products

Avco Key Supply

220 Church St.
Northport, NY 11768
800-332-5397, 516-261-6453
Fax: 800-329-5397
E Mail: AVCOKEY@AOL.COM
Web: www.keyring.com
Mike Avena
Pat O'Leary
Product Categories: F G

Bell's Security Sales Inc.

426 Bloomfield Ave.
Bloomfield, NJ 07003
800-772-2266, 973-743-3709
Fax: 973-743-6357
Dale Middleton Pres.
Rick Middleton Exec. VP
Dennis Jarvis Purch. Agent
Product Categories: A B E F G
See ad on page 59

Berg Wholesale Inc.

P.O. Box 29169
Portland, OR 97229
800-243-8887, 503-220-0000
Fax: 503-228-9410
John Dersch
Paul Meredith
Product Categories: B E F
Branches: 974 Explorers Cove Altamonte
Springs FL 32701
800-582-8107 FAX: 800-528-8180

Blaydes Industries Inc.

2335 18th St. NE
Washington, DC 20018
800-424-2650, 202-832-7100
Fax: 202-832-1359
E Mail: blaydesind@msn.com
Jack Hildebrand Pres.
Tom Rakes VP
Andy Hildebrand Sec. Tres.
Product Categories: A B C E F G D

Blue Dog Key Company

P.O. Box 160006
Altamonte Springs, FL 32716
888-633-2526
E Mail: oddblanks@aol.com
Liam Gribben

Boyle & Chase Inc.

72 Sharp Street,
Hingham, MA 02043
800-325-2530, 781-337-3904
Fax: 800-205-3500
E Mail: sales@boyleandchase.com
Web: www.boyleandchase.com
Michael Rotondi Pres.
Robert Kent Mgr.
Product Categories: B D E F
See ad on page 31

Brady Office Machine Security

11056 S. Bell Ave.
Chicago, IL 60643
800-326-8349, 773-779-8349
Fax: 773-779-9712
E Mail: BBRADY1060@aol.com
Bernadette Brady Pres.
Don Brady
Product Categories: F

Brook's Lock & Supply Inc.

409 6th St. SE
Decatur, AL 35601
800-292-5008, 205-353-2596
Fax: 205-353-8260
E Mail: brooksloc@brooksloc.com

Web: www.BROOKSLOCK.COM
Larry A. Warnick CML Pres.
Carole S. Warnick VP
Bobby Hill GM
Product Categories: A B E F G H
Branches: Huntsville AL
205-830-5990 205-880-7366

Brooks Wholesale

411 6th SE
Decatur, AL 35601
800-292-5008
Fax: 205-353-8260
E Mail: brooksloc@tiger.net-master.net
Web: www.brookslock.com
Larry Warnick
Product Categories: B E F G H

Charman Enterprises

PO Box 496
Eaton, IN 47338
800-247-6324
Fax: 800-647-8449
E Mail: charment@netdirect.net
Web: www.charment.com
Mike Charman

Cisa European Style Locks and Padlocks

10851 NW 29th Street
Miami, FL 33172
305-716-8393
Fax: 305-716-8394
E Mail: lockeyusa@aol.com
Alexander Wertheim Director
Product Categories: F

City Lock & Safe

2898 30th St.
Boulder, CO 80301
303-444-4407
Fax: 303-442-8380
E Mail: Dougsco@aol.com
Jeffrey Rosen Pres.
Product Categories: B D E F G H

Clark Security Products

4775 Viewridge Avenue
San Diego, CA 92123
800-854-2088, 619-505-1950
Fax: 619-974-5290
E Mail: webmaster@clarksecurity.com
Web: www.clarksecurity.com
Marshall Merrifield Pres.
Swan Kurunlla CFO
Peter Berg Marketing
Product Categories: B C D E F G H
Branches:
Anaheim, CA
714-238-9000
Fax: 714-238-9088
Waltham, MA
781-893-5625
Fax: 781-894-1200
Cincinnati, OH
859-746-6500
Fax: 859-746-6509
Chicago, IL
630-350-8535
Fax: 630-350-8535
Denver, CO
303-288-9200
Fax: 303-288-7535
Houston, TX
713-699-1122
Fax: 713-692-9988
Orlando, FL
407-226-6770
Fax: 407-226-6585
Phoenix, AZ

602-275-9235
Fax: 602-275-9235
Sacramento, CA
916-372-6630
Fax: 916-372-7221
Salt Lake City, UT
801-487-3227
Fax: 801-487-3254
San Diego, CA
619-718-9750
Fax: 619-718-9755
Seattle, WA
253-437-0220
Fax: 253-437-0791
Washington, DC
301-731-4100
Fax: 301-731-0849
See ad on page 169

Coast Safe & Lock

P.O. Box 66257
Mobile, AL 36606
334-479-5264
Fax: 334-471-6967
Dennis McLeod

Colonial Lock Supply Co. Inc.

7000-G Newington Rd. P.O. Box 1417
Newington, VA 22122
800-732-9117, 703-550-8558
Fax: 703-550-8857
Gary Baldino GM
Product Categories: B E F G H

Commonwealth Lock Co.

1853 Massachusetts Ave.
Cambridge, MA 02140
800-442-7009, 617-876-3301
Fax: 617-661-3168
E Mail: clc1936@aol.com
Web:
www.commonwealthlockco.bizonthe.net
Edward A. Mayer Pres.
Cathy-Ann Accomando Mgr.
Product Categories: B D E F G H

Craftmaster Hardware Co. Inc.

134 Liberty St.
Hackensack, NJ 07601
800-221-3212, 201-646-9355
Fax: 201-646-0181
E Mail: info@craftmaster.net
Web: www.craftmaster.net
Michael Spingeld Pres.
Anthony Cani VP Sales & Mktg.
Product Categories: B C D E F G H

Curtis Industries A Barnes Distribution Company

1302 E. 9th St.
Cleveland, OH 44114
800-555-5397
Fax: 800-867-6020
E Mail: kathy.previte@bd-bgi.com
Web: www.curtisindustries.com
Kathy Previte
Brenda Brown
Joe Lasio
Product Categories: G

Cypress Security Products Ltd.

5A 4101 19 Street NE
Calgary Alberta, CANADA T2E 6X8
800-561-1967, 403-250-1967
Fax: 403-250-1969
Bruce Bohnet Pres.
Anthony Kadatz Sales Mgr.
Product Categories: B C D E F G

Defiant Safe Co. Inc.

3130 Towerwood Dr.
Dallas, TX 75234

800-225-2984, 972-243-3711
Fax: 972-241-7669
E Mail: defiant@defiantsafe.com
Web: www.defiantsafe.com
Richard Rolland
David Randall
TomBurke
Product Categories: H
Branches: Englewood (Denver) CO
877-763-52
Montebello, CA.
800-334-6060, 303-761-0710

Detroit Mini Safe

11984 N. Telegraph Rd.
Carleton, MI 48117
Larry Arnold

DiMark International Inc.

3117 Liberator - Unit A
Santa Maria, CA 93455
800-235-2435, 805-922-1182
Fax: 805-928-8034
Web: www.pronet.net/dimark
Mark Pirman
Diane Pirman CFO Mgr.
Product Categories: C D F G
See ad on page 53

Direct Security Supply Inc.

36 Lincoln St.
Boston, MA 02135
800-252-5757, 617-787-5200
Fax: 800-452-8600
Ted Stoia Pres.
Jim Condil VP
Product Categories: B C D E F H

DL Services

245A King Street West
Cambridge ONT, Canda N3H 1B8
877-326-5625, 519-653-2538
Fax: 519-653-9539
E Mail: jimcushing@domsecurity.com
Web: www.domsecurity.com
James Cushing
Martin Brown
Product Categories: B F

Door Closer Service Co. Inc.

3730 10th street NE
Washington, DC 20017
Larry Sanders
Angela Sanders
John Edwards
Product Categories: B
See ad on page 40

Door Hardware Distributors Inc.

318 North Milwaukee St.
Milwaukee, WI 53202
800-829-8905, 414-291-5687
Fax: 414-291-5685
E Mail: info@doorhardware.net
Web: www.doorhardware.net
Deborah J. Pokrass Pres.
Andrew S. Pokrass VP Sales
Holly Cayo National Sales Mgr
Product Categories: B G F

Doyle Security Products

2211 West River Road North
Minneapolis, MN 55411
800-333-6953, 612-521-6226
Fax: 612-521-0166
Web: www.doylesecurity.com
Paul M. Justen Pres.
Product Categories: B C D E F G H
Group: USCAN

DRK Specialties Keyrings Key Blanks & Things

392 W. Larch Road Units 32-34
Tracy, CA 95304
800-654-1850, 209-832-4100
Fax: 888-588-0667
Don R. Kuhn Pres.
Gloria Kuhn Treas.
Product Categories: G

Dugmore and Duncan

30 Pond Park Rd.
Hingham, MA 02043
888-384-6673
Fax: 888-329-3846
E Mail: sales@dugmore.com
Web: www.dugmore.com
Lisa Faherty Branch Operations Mgr.

Ed Minishak Sales Director
Product Categories: B E F G
See ad on page 17, 19
Branches: Corona CA
888-384-6673
Lakeland FL, 888-384-6673
Lombard IL, 888-384-6673

E.L. Reinhardt Company

3250 Fanum Rd.
Vadnais Heights, MN 55110-5219
800-328-1311, 651-481-0566
Fax: 651-481-0166
E Mail: elreinhard+@uswest.net
Web: www.plsgroup.com
Kenneth J. Stemig Pres.
Kenneth Paul Stemig VP
John Eldred Stemig VP
Product Categories: A B C D E F G H
Group: Plus Distribution Group

Safe Opening Articles 1987

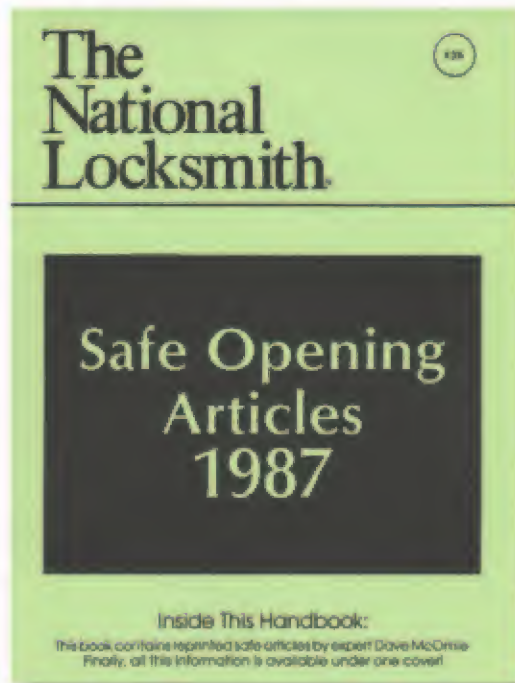

Now under one cover—all the information safe opening articles by expert safeman, Dave McOmie.

[CLICK HERE TO LEARN MORE](#)



#SA - 1

DISTRIBUTORS

Basic Masterkeying Course

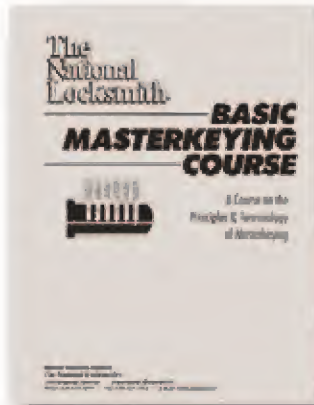

13 Lesson
450 page course

The Basic Masterkeying course is designed for the locksmith who wishes to become proficient in Basic Masterkeying.

CLICK HERE TO LEARN MORE



#MK - 1

Empire Security Supplies

4600 B Neconset Hwy.
Pt. Jefferson Station, NY 11776
516-928-1919, Fax: 516-928-4745
Ira Levine Pres.
Product Categories: A B E F H

Encon Electronics

28310 Industrial Blvd
Hayward, CA 94545
800-782-5598, 510-782-5598
Fax: 510-782-4290
E Mail: encon@california.com
Web: www.enconelectronics.com
Joe Weber Sales Manager
Product Categories: E F

Enixus Trade Ltd.

34 Dunkirk Rd.
St. Catharines Ont., CANADA L2R 1A1
905-682-3086
Fax: 905-682-3086
George Papaiz Director
Bruno Papaiz Director
Product Categories: B F G

Ewert Wholesale Hardware Inc.

4709 W. 120th St.
Alsip, IL 60803
800-451-0200, 708-597-0059
Fax: 708-597-0881
Brian King Sales
A. Wesley McKenney
Dennis Harmon
Product Categories: B C D E F G H

Express Hardware

1203 S. Northwest Hwy.
Barrington, IL 60010
800-323-7447, 847-381-9430
Fax: 847-381-7199
Steve Yellin Pres.
Product Categories: B E F

Fairway Supply Inc.

2631 Lomabardy Lane
Dallas, TX 75220
800-776-3247
Fax: 214-352-4299
E Mail: fairwayinc@aol.com
Don Bradford C.E.O.
Rick Gummelt Pres., Bob Conley VP
Product Categories: A B C D E F G H
Branches: Houston TX
800-767-3247, 713-957-2122

Fastrack Hardware Inc.

W165 N5690 Continental Parkway
Menomonee Falls, WI 53051
800-458-8707, 262-781-8118
Fax: 800-667-8701 or 262-781-1162
Paul Federspiel Cust. Svc.
Dennis Jacque Pres.
Darwin Radliff Sales
Product Categories: B E F

Foley Belsaw Co. Locksmith Division

6301 Equitable Rd.
Kansas City, MO 64120
800-821-3452, 816-483-2700
Fax: 816-483-5010
George Doetzl Pres.
Product Categories: C D F G

Fortress Safe & Lock

336 Northland Blvd.
Cincinnati, OH 45246
800-562-0295, 513-772-4392
Fax: 513-326-5983
Don E. Eveatt Jr. President
Ron Heflin VP

Donna Hendrickson Asst. GM
Product Categories: B E F G

Fradon Lock Co. Inc.

467 Burnet Ave.
Syracuse, NY 13203
800-447-0591, 315-472-6988
Fax: 315-472-0958
E Mail: fradonlock@aol.com
Don Rapp Pres.
Hope Tucker Sales Mgr.
Jim Rapp Auto. Sales
Product Categories: B C E F G H
See ad on page 121

Fried Bros. Inc.

467 N. 7th St.
Philadelphia, PA 19123
800-523-2924, 215-627-3205
Fax: 215-592-1255
E Mail: fbisecurity@fbisecurity.com
Web: www.fbisecurity.com
Alex Ebrahimzadeh Pres.
Sonia Starr Purch. Mgr.
Product Categories: A B C D E F G H
Group: USCAN

Garden State Hardware Wholesalers

322 W. Front St.
Planfield, NJ 07060
800-544-0616, 908-753-1343
Fax: 908-753-2040
Rich Nabozny Pres.
Ted Nabozny VP
Ed Ciesla Purchasing
Product Categories: A B C D E F G H
See ad on page 85

Gil-Ray Tools Inc.

1306 McGraw St. P.O. Box 801
Bay City, MI 48707
517-892-6870
Fax: 517-892-6870
E Mail: DJDEUEL@BIGFOOT.COM
Web: www.angelfire.com/biz/gilraytoolsinc/
David J. Deuel Pres.
Laurie A. Gatzka Cust. Svc. Mgr.
D.J. Deuel Cutter Sharp. & Sales
Product Categories: C G
See ad on page 55

Great Southern Security

7403 Monticello Drive
Villa Rica, GA 30180
770-830-7999
John Anderson

H & H Lock & Security Wholesalers

9140 Gaither Rd.
Gaithersburg, MD 20877
800-772-9811, 301-948-1996
Fax: 301-948-5265
E Mail: hhlock@erols.com
Web: www.hhlock.com
Paul E. Jacobson Pres.
Greg A. Jacobson VP
Richard J. Berman Mgr.
Product Categories: B F H E

H.E. Mitchell Co.

118 SE 8th Ave.
Portland, OR 97214
800-626-5625, 503-236-9444
Fax: 503-238-5715
Judy Messing
Mike Messing VP
Bob Thompson VP
Product Categories: A B C D E F G H
See ad on page 92
Group: Plus Distribution Group

H.S. & S. Wholesale Dist. of Lock Hardware.

12911 W. 8 Mile
Detroit, MI 48235
800-521-2202, 313-342-6777
Fax: 313-342-7580
Michael Solomon Pres.
Product Categories: B D E F G H

Hahn & Schaffner Inc.

88 Boss St.
Bolivar, NY 14715
888-645-8696, 716-928-2850
Fax: 716-928-2852
Paul Lowry
Product Categories: A B E F G H

Hans Johnsen Co.

8901 Chancellor Row
Dallas, TX 75247
888-879-1500, 214-879-1550
Fax: 214-879-1530
E Mail: LOCKHJC@AOL.COM
Web: www.hjc.com
Howard H. Johnsen Pres.
Saul Espinoza VP Lock Prod./Purch.
Reid Hill Mktg. Dir.
Product Categories: B D E F G H
Group: USCAN

Hardinge Bros. Limited

3375 14 Ave. Unit 1
Markham Ontario, Canada L3R 0H2
905-470-8844
Fax: 905-470-2767
E Mail: hardinge@accessv.com
Web: www.cansecure.com
Sharon Craik, Ron Bertram
Paul J. W. Leonard
Product Categories: A B E F

Hardware Agencies Ltd.

1220 Dundas St. East
Toronto Ont., Canada M4M 1S3
800-268-6741, 416-462-1919
Fax: 416-462-1922
E Mail: sales@hardwareagencies.com
James Roberts Mktg. Mgr.
Lorne Factor GM
Product Categories: A B C D E F G H

Hardware Suppliers of America Inc.

P.O. Box 2208
Winterville, NC 28590
800-334-5625, 919-355-9495
Francis Casey Pres.
Sanda Godwin Cust. Svc. Mgr.
Product Categories: B F

Hawley Lock Supply

5041 E. Elliot Road
Phoenix, AZ 85044-1714
800-398-2458
Fax: 602-592-0105
Web: www.hawleylock.com
James Hawley

Herbert Flake Co.

5005 I-45 South (Gulf Freeway)
Houston, TX 77023
800-231-4105, 713-926-3200
Fax: 713-926-3399
E Mail: DanF@hflflake.com
Web: www.hflflake.com
Dan Floeck Pres.
Jacob Eapen Purch. Mgr.
Joe Chambers Sales Mgr.
Product Categories: B C D E F G H

HMC Int'l Div. Inc.

5996 S. Crocker St.

Littleton, CO 80120-2054
800-848-4912 ext. 4452, 303-794-2510
Fax: 303-794-3703
Tito Howard Pres.
P.J. Howard VP
Product Categories: B G

Howard Sales Co.

4625 Ripley Dr.
El Paso, TX 79922
800-456-4625, 915-833-7733
Fax: 915-833-7770
E Mail: howard@whc.net
Web: www.howardsales.com
Bill Uhlig
Product Categories: B E F G

Independent Hardware Inc.

14 S. Front St.
Philadelphia, PA 19106
800-346-9464, 215-925-5306
Fax: 215-922-6552
E Mail: ROOMMATE4@AOL.COM
Frank Stanco Pres.
Vincent Campagna VP
Product Categories: B E F G

InstaCode 200 I

1533 Burgundy Parkway
Streamwood, IL 60107
630-837-2044
Fax: 630-837-1210
E Mail: natlock@aol.com
Web: www.TheNationalLocksmith.com
John McMullen
Marc Goldberg
Product Categories: D

Intek Global Corp. (Midland Land Mobil Radio)

1690 N. Topping Ave.
Kansas City, MO 64120
800-669-4567, 816-241-8400
Fax: 816-920-1144
Product Categories: E

Intermountain Lock & Supply

2300 W. 2nd Ave. Unit B
Denver, CO 80223
800-323-8046, 303-698-1898
Fax: 303-698-2094
Jay Hickenlooper Pres.
Bob Steinman VP
Lenny Guida Mgr.
Product Categories: A B C D E F G H

International Distribution Network

2401 Mustang Dr., Ste. 100
Grapevine, TX 76051
817-421-5470
Fax: 817-421-5468
Mike Groover President
Al Hoffman VP
Viril Mullins Secretary/Treasurer

IDN-Acme, Inc.

PO Drawer 13748
New Orleans, LA 70185
504-837-7315
Fax: 504-837-7321
Product Categories: A B C D F G H
Branches:
Bellaire, TX
713-668-0022
Fax: 713-668-8050
San Antonio, TX
210-545-3396
Fax: 210-545-2198
Ft. Worth, TX

817-284-5696
Fax: 817-284-3501
Oklahoma City, OK
405-942-8750
Fax: 405-942-0523
Richardson, TX
972-664-1240
Fax: 972-664-1252
Denver, CO
303-922-3041
Fax: 303-922-7493

IDN-Armstrong's, Inc.

1440 Dutch Valley Place NE
Atlanta, GA 30324
404-875-0136
Fax: 404-888-0834
Product Categories: A B C D E F G H
Branches: N. Miami Beach, FL
305-651-1598
Fax: 305-652-1709
Tampa, FL
813-886-8007
Fax: 813-886-5696
Norfolk, VA
757-853-0611
Fax: 757-853-1832
Jacksonville, FL
904-387-0663
Fax: 904-387-4568
Orlando, FL
407-297-7722
Fax: 407-297-9522

IDN-Canada, Ltd.

70 Floral Parkway
Toronto, Ont., Canada M6L 2C1
416-248-5625
Fax: 416-248-9945
Product Categories: A B C D E F G H
Branches:
Ottawa, Ont., Canada
613-749-2172
Fax: 613-749-6651
Calgary, Alberta, Canada
403-291-4844
Fax: 403-291-4893
Edmonton, Alberta, Canada
403-944-0014
Fax: 403-944-0929
Vancouver, BC, Canada
604-253-0017
Fax: 604-253-5344
Dartmouth, Nova Scotia, Canada
902-468-1373
Fax: 902-468-2117

IDN-Hardware Sales, Inc.

35950 Industrial Road
Livonia, MI 48151
734-591-1150, Fax: 734-591-7289
Product Categories: A B C D E F G H
Branches:
McKees Rock, PA
412-771-6122
Fax: 412-771-6350
Detroit, MI
810-755-3658
Fax: 810-755-5145
Parma, OH

PRODUCT CATEGORY KEY

- A — Alarms
- B — Architectural Hardware
- C — Training Manuals & Materials
- D — Locksmith Software
- E — Electronic Security Products
- F — Locking Products
- G — Locksmith Tools & Equipment
- H — Safes & Safe Products

216-335-9740
Fax: 216-335-9745
Cheektowaga, NY
716-683-1935
Fax: 716-683-2464
South Windsor, CT
860-289-9457
Fax: 860-289-0309
East Syracuse, NY
315-432-8450
Fax: 315-432-8474

IDN-H. Hoffman, Inc.

733 W. Montrose Ave.
Norridge, IL 60706
708-456-9600
Fax: 708-456-0878
Product Categories: A B C D E F G H

Branches:

Indianapolis, IN
317-635-8100
Fax: 317-637-2358
St. Louis, MO
314-692-8391
Fax: 314-692-8395
Grand Rapids, MI
616-534-1067
Fax: 616-534-1904
Butler, WI
414-790-9750
Fax: 414-790-9754
Overland Park, KS
913-599-4111
Fax: 913-599-4160
Cincinnati, OH
513-271-8530
Fax: 513-271-8567
Davenport, IA
319-391-8366
Fax: 319-391-7949
Omaha, NE
402-592-1652
Fax: 402-592-9604
Bloomington, MN
612-886-3840
Fax: 612-886-3841

IDN-M. Taylor, Inc.

5635-45 Tulip Street
Philadelphia, PA 19124
215-288-5588
Fax: 215-288-2511
Product Categories: A B C D E F G H

IDN-West, Inc.

2602 N. 37th Drive
Phoenix, AZ 85009
602-272-5300
Fax: 602-272-5777
Branches:
Pico Rivera, CA
562-463-4870
Fax: 562-463-5570
Las Vegas, NV
702-736-4553
Fax: 702-736-4579

Island Pacific Distributors Inc.

240-A Puuhale Rd.
Honolulu, HI 96819
808-955-1126
Fax: 808-946-6480
Leon Wolfley Pres.
Barbara Wolfley VP
Earl Tokuda Sales Mgr.
Product Categories: A B E F G H

**J. Nathan
Hardware
Specialties Inc.**

P.O. Box 18159

Rochester, NY 14618
800-634-2580, 716-325-3330
Fax: 716-325-7196
E Mail: @jnathan.com
Web: www.jnathan.com
Jim Bono Pres.
Mark Putnam Cust. Svc. Mgr.
Product Categories: B C D E F
See ad on page 89
Branches: Victor NY
716-325-3330

J.S.A. International Inc

4397 N. Pine Island Rd
Sunrise, FL 33351
954-741-3111, Fax: 310-534-1084
Jack Matatof

Jack Stearman Ltd.

338 West 6th Ave.
Vancouver B.C., Canada V5Y 1K9
604-872-8415
Fax: 604-875-9174
John Stearman Pres.
Edna Nichols
John Stearman Jr.
Product Categories: B C D E F G H
Group: USCAN

Jim Ripley's Services Inc.

304 S. Lynn Riggs Blvd.
Claremore, OK 74017
918-341-1077
Jim Ripley Pres.
James Ripley Serviceman
Product Categories: G

JLM Wholesale Inc.

3095 Mullins Ct.
Oxford, MI 48371
800-522-2940, 248-628-6440
Fax: 800-782-1160
E Mail: sales@jlmwholesale.com
Web: www.jlmwholesale.com
Raymond Baldwin Pres.
Product Categories: B E
Branches: Charlotte NC
800-768-6050

**Jo-Van
Distributors Inc.**

929 Warden Ave.
Scarborough Ont., Canada M1L 4C5
888-752-7210, 416-752-7210
Fax: 888-752-3845
E Mail: SALES@JOVANLOCK.COM
Web: www.JOVANLOCK.COM
Leonard J. Passarello CPL
Product Categories: A B C D E F G H
Group: USCAN

JW Benton Ltd.

3491 Main St.
Vancouver BC, Canada V5V 3M9

KDL Hardware Supply

P.O. Box 21226
Seattle, WA 98111
800-524-9305, 206-682-7383
Fax: 800-524-9305
E Mail: REX@ESKIMO.COM
Web: www.KDLLINK.COM
Peggy Steck Inside Sales
Al Chraca Outside Sales
Scott Cottrell Territorial Sales
Product Categories: A B C D E F G H
Group: USCAN

Key Mart Inc.

3010 SE Monroe St.
Stuart, FL 34997
800-228-7755, 561-283-8029

Fax: 561-220-7920
Ernie Stephan CEO, Ken Stephan VP
Product Categories: B F H

Key Products

2555 International St.
Columbus, OH 43228
614-876-7704
Fax: 614-876-1437
Matthew Finn

Key Sales & Supply Co.

9950 Freeland Ave.
Detroit, MI 48227
800-445-KEYS (5397), 313-931-7720
Fax: 313-931-7758
Michael Wiener Pres.
Product Categories: A B C D E F G H
See ad on page 78

Key Supply

362 7th St.
San Francisco, CA 94103
415-626-2526, Fax: 415-626-4598

Keys Plus Distributing

454 Young St.
Tonawanda, NY 14150
800-644-5397, 716-743-0220
Paul J. Ferretti Owner
Product Categories: F G

Keys Wholesale Distributors Inc.

P.O. Box 498
Drexel Hill, PA 19026
800-292-5397, 610-626-4787
Fax: 610-626-4189
Bill Kline Pres., Dottie Kline Sec.
Product Categories: B C F G H

Kolson Inc.

653 Middle Neck Rd.
Great Neck, NY 11023
800-783-1335, 516-487-1224
Fax: 516-487-1231
E Mail: KOLSON@IDT.NET
Dale Kolson VP
Sandy Lamberg GM
Addie Finn Wholesale Div. Mgr.
Product Categories: B F

Kramer Boys Locksmith Supply

1602 E. State St.
Trenton, NJ 08609
800-222-2692, 609-586-0642
Fax: 609-586-0512
Adam Kramer
Scott Kramer VP
Robert Kramer Sec.
Product Categories: A B C E F G H

LDM Enterprises Inc.

638 Lindero Cyn. Rd.
Agoura, CA 91301
800-451-5950
Fax: 818-706-8560
E Mail: LDMINFO@LDMENT.COM
Web: www.LDMENT.COM
Leslie Medina
Product Categories: C D F G

Le'Clasp

85 Industrial Drive
Phillipsburg, NJ 08865
908-213-9233
Fax: 908-454-5394
Brian Buckley

Lion Security Products

2611 Ulysses St NE
Minneapolis, MN 55418
612-789-7657
Fax: 612-789-0706
Beth Kirby

DISTRIBUTORS

DISTRIBUTORS

Lockmasters Inc.

5085 Danville Rd.
 Nicolasville, KY 40356
 800-654-0637, 606-885-6041
 Fax: 606-885-7093
 E Mail: sales info@lockmasters.com
 Web: www.lockmaster.com
 J. Clayton Miller CEO
 Mark C. Miller Pres. Tool & Equip
 Wesley Day VP Tool & Equip. Div.
Product Catagories: C E F G H
 See ad on page 77

Locks Co.

2050 NE 151 St.
 N. Miami, FL 33162
 800-288-0801, 305-949-0700
 Fax: 305-949-3619
 E Mail: LOCKSCO@GATE.NET
 Web: www.LOCKSCO.COM
 Milton Dorn Pres.
 Mark Dorn VP
 Mike Dorn GM
Product Catagories: B C D E F G H
 Group: Plus Distribution Group

**Locksmith
 Dispatcher 2000**

1533 Burgundy Parkway
 Streamwood, IL 60107
 630-837-2044
 Fax: 630-837-1210
 E Mail: natllock@aol.com
 Web: www.DiamondSoftwareSystems.com
 Faron Dunn
 Marc Goldberg
Product Catagories: D

Locksmith Store Inc., The

1229 E. Algonquin Rd. Unit E
 Arlington Heights, IL 60005
 847-364-5111
 Fax: 847-364-5125
 Web: www.locksmithstore.com
 Tom Swiderek President
 Josh Swiderek Customer Svc.
 Jack Swiderek Customer Svc.
Product Catagories: D F G

LV Sales Inc.

1831 Hyperion Ave
 Los Angeles, CA 90027
 800-894-keys, 323-661-4746
 Fax: 323-661-1314
 E Mail: sales@lvsales.com
 Web: www.lvsales.com
 Bernard Poulin
Product Catagories: A B C D E F G H
 See ad on page 131

**Lyn/Lad Truck Equipment Div
 of Lyn/Ladder**

PO Box 346
 Lynn, MA 01905
 800-225-2510
 Mark Tremblay

**M. Shepe Co. Div. American
 Bionics**

21st and East Carson Sts.
 Pittsburgh, PA 15203
 800-666-6007, 412-381-4900
 Fax: 412-381-5122
 Sanford Zarembeg VP
Product Catagories: A B D E F G H

Majestic Lock

194 Daniel St.
 Hackensack, NJ 07601
 Stephanie MacFarlane

Major Lock Supply

2512 E. Fender Ave. Suite F
 Fullerton, CA 92631
 714-447-8363
 Fax: 714-447-8393
 Ken Jordan President
 Bob Lange General Manager
Product Catagories: B C D E F G H
 Group: USCAN

Martco

337 Byrne Ave.
 Louisville, KY 40209
 800-233-7769, 502-635-1600
 Fax: 502-637-6430
 Web: www.martcoinc.com
 Garry Armstrong
 Beau Hicks
 Jim May
Product Catagories: A E
 Branches: Memphis TN
 800-399-7769, 901-345-3171

Maryland Security Distributors

8 Aquahart Rd # 200
 Glen Burnie, MD 21061
 800-390-8889, 410-760-5625
 Eric Roes
 Tanja Roes
Product Catagories: A B C D E F G H

MasterLink Security Products

3863 NW 19th St.
 Lauderdale Lakes, FL 33311
 954-581-2002
 Fax: 954-581-9363
 Roger Tuttle

**Mayflower Sales
 Co. Inc.**

614 Bergen St.
 Brooklyn, NY 11238
 800-221-2052, 718-622-8785
 Fax: 718-789-8346
 E Mail: PILGRIM@MFSALES.COM
 Web: www.MFSALES.COM
 Bill Swetow Pres.
 Paul Swetow VP
 Brian O'Dowd Mgr. Lock Division
Product Catagories: B C D E F G H

**Maziuk Wholesale
 Distributors**

1251 W. Genesee St.
 Syracuse, NY 13204
 800-777-5945, 315-474-3959
 Fax: 315-472-3111
 E Mail: sales@mzkworld
 Web: www.mzkworld.com
 Stanley Maziuk Pres.
Product Catagories: A B C D E F G H
 Group: Plus Distribution Group
 Branches: Buffalo NY
 716-684-9133, 716-684-5192, 888-777-6981

MBA USA, Inc.

101 Edgewood Plaza Dr.
 Nicholasville, KY 40356
 888-622-5495, 606-887-0496
 Fax: 606-887-9491
 E Mail: MBATOOLS@AOL.COM
 Web: www.mbausa.com
 Mark Bates Pres.
Product Catagories: C G H

**McDonald Dash Locksmith
 Supply Inc.**

P.O. Box 752506
 Memphis, TN 38175-2506
 800-238-7541, 901-797-8000
 Fax: 901-366-0005

E Mail: JIMDT@AOL.COM
 Jim Thomas Pres.
 Bette F. Arndt Exec. VP
 Burma Hanson VP
Product Catagories: A B C D E F G H
 Group: Plus Distribution Group

**McGregor Hardware
 Distribution Ltd.**

1137 Keefer Street
 Vancouver BC, CANADA V6A 1Z2
 800-663-5625, 604-253-7785
 Fax: 604-253-7676
 Tom Donaldson

**McManus
 Locksmith Supply
 Inc.**

P.O. Box 9321
 Charlotte, NC 28299
 NC 800-432-6342 SC 800-438-6567
 704-333-9112 or 704-333-0556
 Fax: 704-332-8664
 E Mail: mclock@bellsouth.net
 John W. Dyson Pres.
 Benjamin O. Lewis VP
 Betty M. Lewis Sec. Treas. Mgr.
Product Catagories: B D F G H C

MD Wholesale Hardware

953 Seton Ct.
 Wheeling, IL 60090
 800-345-7116, 847-541-0010
 Fax: 847-541-0020
 E Mail: info@mdhardware.com
 Web: www.mdhardware.com
 Mark Echales Vice Pres.
 Andy Dellamaria General Mgr.
 Barry Schaff Inside Sales Mgr.
Product Catagories: A B E F

Metro Safe Co. Inc.

30845 John R
 Madison Heights, MI 48071
 800-541-8050, 810-585-7230
 Fax: 810-755-1760
 Orest Kalba Pres.
 John Szechowycz VP
Product Catagories: H
 Branches: Warren MI
 810-755-3570

Mid-South Locksmith Supply

P.O. Box 18468
 Memphis, TN 38181
 800-238-6166, 901-795-6987
 Fax: 901-795-3475 888-795-3475
 E Mail: MIDSOUTHCLK@AOL.COM
 Don Chandler
 Bill Chandler Sales
Product Catagories: B C D E F G H

Midwest Safe Distributors

P.O. Box 5310
 Philadelphia, PA 19153
 800-713-7233, 215-492-2024
 Fax: 800-355-1195 or 215-492-2025
 Lynn Gray Sales Mgr.
Product Catagories: H

PRODUCT CATEGORY KEY

- A — Alarms
- B — Architectural Hardware
- C — Training Manuals & Materials
- D — Locksmith Software
- E — Electronic Security Products
- F — Locking Products
- G — Locksmith Tools & Equipment
- H — Safes & Safe Products

Midwest Wholesale Hardware

P. O. Box 34221
Kansas City, MO 64120
800-821-8527, 816-241-5663
Fax: 800-621-6581
E Mail: HDWSales@midwestwholesale.com
Bob England Pres. & GM
Diana England Purch. Mgr.
Product Categories: B E F
See ad on page 93
Branches: Longwood FL
800-659-8527
Visalia CA
888-707-8527

Monaco Lock Company Inc.

339-345 Newark Ave.
Jersey City, NJ 07302
800-526-6094, 201-659-7969
Fax: 201-659-7970
E Mail: MONACOLOCK@AOL.COM.
Web: www.monacolock.com
Nancy Juskey V.P. Sales
Barbara Garretson Sales Rep.
Product Categories: B E F

Monday Security Corp.

425 Marshall Ave
Webster Grove, MO 63119
314-962-8787
Fax: 314-9620791
Laurie Smith

National Auto Lock Service Inc.

PO Box 1275
San Bruno, CA 94066
800-954-5454, 415-757-0700
Fax: 415-757-9200
E Mail: sales@laserkey.com
Web: www.laserkey.com
Michael Hyde
Product Categories: G

National Locksmith, The

1533 Burgundy Parkway
Streamwood, IL 60107
630-837-2044
Fax: 630-837-1210
E Mail: natllock@aol.com
Web: www.TheNationalLocksmith.com
Marc Goldberg Publisher
Product Categories: C D G H

New England Door Closer Inc.

694 Union St. P.O. Box 28
West Springfield, MA 01090
800-628-1071, 413-733-7889
Fax: 413-731-8368
E Mail: nedc@worldnet.att.net
R.E. Longley Pres.
Product Categories: B

New York Locksmith Supply Co. Inc.

1558 2nd Ave.
New York, NY 10028
212-737-0178, 914-328-1919
Fax: 212-988-9192
Neal Geffner Pres.
Len Geffner Sec.
Barry Silver Nat'l. Sales Mgr.
Product Categories: F G

Northeast Lock Corp.

48 Oak St.
Clifton, NJ 07014
800-524-2575, 201-777-7509
Fax: 800-524-2576
George Polke President

Kim Palmer Sales
Kevin McCallen Sales
Product Categories: F

Northwest Lock & Supply Co.

1418 Pacific Blvd .P.O.Box 1384
Albany, OR 97321
800-359-9425, 541-967-2749
Fax: 541-928-9338
Ted Swanson CEO
Richard Kitchen Sales Mgr.
Steve Swanson GM
Product Categories: B C D E F G H

O'Brien Bros. Inc.

380 Union St.
W. Springfield, MA 01089
800-343-0949, 413-734-7121
Fax: 413-737-1642
Joseph S. O'Brien
Product Categories: B D E F G

Ohio Travel Bag Mfg. Co.

6481 Davis Industrial Pkwy.
Solon, OH 44139
800-800-1941, 440-498-1955
Fax: 440-498-9811
Web: www.ohiotravelbag.com
Paul Gallin
Bruce Oppenheim Exec. VP
Ray Patel VP Sales
Product Categories: F
See ad on page 152

Omaha Wholesale Hdwe.

P.O. Box 3628
Omaha, NE 68103
800-238-4566, 402-444-1673
Fax: 800-538-4566
William J. Stock Pres.
Howard Westenberg Mgr.
Product Categories: A B C D E F G
See ad on page 23

Orchard Lock Distributors Inc.

30 Edmond St
Hamden, CT 06517
800-233-2146, 203-865-8106
Fax: 203-624-4083
William Simmons Nat'l. Sales Mgr.
Paul Douglass Reg. Acct. Exec.
Michael Jenoint Reg. Acct. Exec.
Product Categories: B C F G H

Orion Pacific Trading Company

3972 Barranca Pkwy #J
Irvine, CA 92606
949-830-2003
Fax: 949-830-5668
J. Bruce Such Pres.
Vincent Chan VP
Product Categories: F

Padlocks4less.com

PO Box 75449
Seattle, WA 98125
206-972-4557, Fax: 206-523-9876
E Mail: info@padlocks4less.com
Web: www.padlocks4less.com
Tim Freeman
Product Categories: B F

Pasek Corp.

9 West Third St.
So. Boston, MA 02127
800-628-2822, 617-269-7110
Fax: 617-269-0547 or 800-262-0547
E Mail: PASEK@PASEK.COM
Lewis A. Alessandrini Pres.
Product Categories: A B D E F G

Perry Blackburne Inc.

33 Meeting St.
Cumberland, RI 02860
800-556-7474, 401-725-7611
Web: www.perryblackburne.com
Mark Rosenberg Vice President Sales & Mktg., Perry Mermelstein President
Product Categories: F

Pimlico Key Service Inc.

5254 Reistertown Rd.
Baltimore, MD 21215
800-638-3815, 410-367-7400
Fax: 410-367-7319
John Trouland Pres.
Product Categories: F G

PLS Distribution Group

3250 Fanum Rd.
Vadnais Heights, MN 55110
612-481-0566
John Stemig

Power Company, The

3213 W. Wheeler St.
Seattle, WA 98199
206-624-5090, Fax: 206-284-1138
E Mail: powrcompny@earthlink.net
Web: www.thepowercompanyinc.com
Claudette Sales
Tony GM
Product Categories: G

Pride Barco Lock Company

116 North Nopal St. Ste. 4
Santa Barbara, CA 93103-3334
800-578-1816, 805-965-8819
Fax: 805-965-2535
E Mail: pride.barco@mindspring.com
Web: http://mindspring.net/npride.barco/
Armand J. Renga President
Ian Renga Gen. Mgr.
Product Categories: B F H

Progressive Hardware Inc.

63 Brightside Ave.
East Northport, NY 11731
William Zilz

R & H Wholesale Supply Inc.

1655 Folsom St.
San Francisco, CA 94103
415-863-0404
Fax: 415-863-7046
Bob Heath
Product Categories: A B C D E F G
Group: Plus Distribution Group

R.A. Graham Co. Inc.

70 James St.
Worcester, MA 01603
800-333-3933, 508-755-5815
Fax: 888-755-6584
Andy Graham Pres.
Bob Combs GM
Product Categories: B F

R.B. Enterprises

42654 Deep Forest Dr
Coarsegold, CA 93614
209-642-2710
Fax: 209-642-2699
Bob Barr

RA-Lock Company

P.O. Box 549
Cedar Hill, TX 75106
800-777-6310, 972-775-6301
Fax: 972-775-6316
E Mail: ralock@rlindustries.com
Web: www.rlindustries.com
J.J. Gage C.E.O.
David Price Pres.

Betty Willoxson Order Svc.
Product Categories: F

RHS Security Hardware

P.O. Box 3811
Akron, OH 44314
880-848-3348, 330-753-3257
Fax: 303-848-3338
Howard Schutte
Jennife Schntte
Product Categories: A B C D E F G

Richardson Electronics Ltd.

P.O. Box 393
La Fox, IL 60147
800-348-5580, 630-208-2200
Fax: 630-208-2550
Web: www.rell.com
Edward J. Richardson CEO
William Garry CEO
Joseph Grill VP Human Resources
Product Categories: A E

Richmond Industrial Supplies

68 Port Richmond Ave.
Staten Island, NY 10302
800-462-9997, 718-448-2100
Fax: 718-981-5665
Bob
Kevin Sales
Dan Sales
Product Categories: B

Rininger Lock & Supply

3468 Citrus St. Ste. C
Lemon Grove, CA 91945
619-463-0170
Fax: 619-697-2590
E Mail: RININGER@ELECTRICITI.COM
Web:
www.ELECTRICITI.COM/RININGER
Chuck Rininger Owner
Brian J. Goonan Purch. Sales
Product Categories: B C D E F G H

Robert Skeels & Company

19216 S. Laurel Park Rd.
Compton, CA 90220
800-734-4539, 310-639-7240
Fax: 310-639-7569
Web: www.SKEELS.COM
Kenneth Jordan Pres.
Bob Lange GM
Product Categories: B C D E F G H
Group: USCAN
Branches: Fullerton CA
714-447-8363, Fax: 714-447-8393

S & J Products & Services

P.O. Box 10154
Yakima, WA 98909-1154
800-735-1797, 509-575-1797
Fax: 509-575-1875
Jack Baugher
Product Categories: A E H

S.D.I. (Security Distributors, Inc)

8901 Chancellor Row
Dallas, TX 75247
214-879-1563
Fax: 214-879-1525
Howard Johnsen, President
Paul Justen, V.P.
Ron Snyder, V.P.
Product Categories: B E F G H

Safe Depot

999 Lees Mill RD
College Park, GA 30349
877-723-3001, 658-337-0010
Fax: 678-337-0014
E Mail: www.lefty1203@aol.com
Michael Dorn

Safe Warehouse International

10932 Murdock Rd. Suite 105
Knoxville, TN 37932
800-695-2815
Fax: 423-675-2850
Betty Blackburn

Safemasters Company Inc.

5655 General Washington Drive
Alexandria, VA 22312
800-633-9977, 703-256-6402
Fax: 703-750-1814
Web: www.safemasters.com
Robin Scheirer Pres.
Henry Raymond VP
Jay Von Runnen Dir. Ind. Sales
Product Categories: A B C D E F H
See ad on page 125
Branches:
Philadelphia PA

888-768-7387
Fax: 888-763-2987
Silver Spring MD
301-565-2100
Fax: 301-495-7810
Alexandria VA
800-633-9977
Fax: 703-750-1814
Baltimore MD
410-624-3300
Fax: 410-947-4230
Chesapeake VA
757-420-0404
Fax: 757-424-1148
Barrington NJ
856-547-4706
Fax: 856-547-7308
Little Falls NJ
201-391-0081

Penetration Party

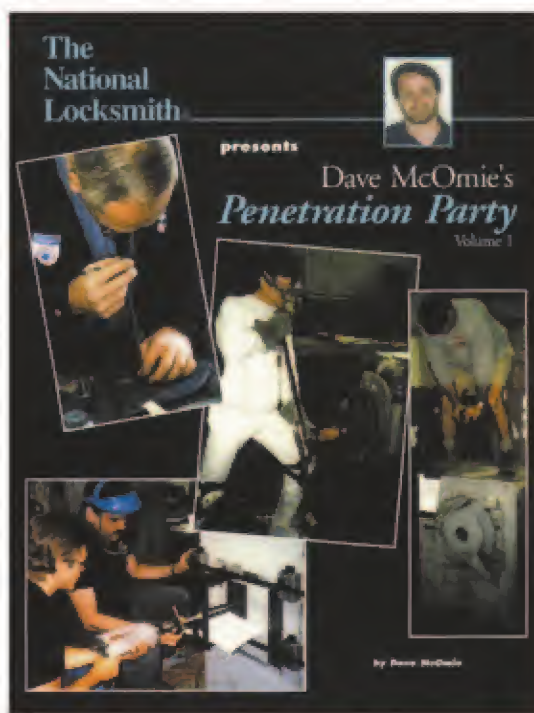

- Uncensored! • The Safes! • The Tools!
- The Action! • The Perfect Openings!
- The Bloopers and Blunders!
- The Slick Tricks!

[CLICK HERE TO LEARN MORE](#)



#PP - 1

DISTRIBUTORS

Fax: 973-890-7676
Pittsburgh PA
412-821-5166
Fax: 412-821-5166
Wilmington DE
302-777-5925
Fax: 302-777-5928
Dover DE
302-697-9140
Fax: 302-489-5303
Indianapolis IN
317-328-9683
Fax: 317-328-2682
Des Plaines IL
847-299-3420
Fax: 847-299-4039
Chicago IL
312-627-1440
Fax: 312-627-1519
Boston MA
617-423-4846
Fax: 617-350-7558
Malden MA
781-324-8000
Fax: 781-321-8803

Safer Image

4707 N High St
Columbus, OH 43214
614-447-0000
Fax: 614-412-0008
Tim Finley

Secure Car Enterprises

1965-1 New Hwy.
Farmingdale, NY 11735
516-293-8030
Fax: 516-293-0690
Jim Reily

Secure Industries Inc.

9 Kuhl Ave.
Hicksville, NY 11801
800-999-2534, 516-433-0033
Fax: 516-433-8804
Web: www.SECURE INDUST
Joel Kramer Pres.
Sadie Kramer VP Sales
Bruce Witken Sales
Product Categories: B F G

Security Equipment Supply

4132 Shoreline Dr. Ste. E
Earth City, MO 63045
800-325-0221, 314-298-8930
Fax: 314-298-8962
Bob Van Dillen Pres.
George Trussler Oper. Mgr.
Product Categories: A E

Security House Padlock Distributors

665 Milway Ave. Unit 48
Concord Ontario, CANADA L4K 3T8
888-PADLOCKS "Canada wide",
905-669-5300
Fax: 905-660-6313
J.W. (Jim) Flewitt Pres.
John Callaghan VP Oper./Purch.
Orest Drohobycky Sales Coord.
Product Categories: B E F H G

Security Lock Distributors

P.O. Box 815
Needham Heights, MA 02194
800-847-5625, 781-444-1155
Fax: 800-878-6400
E Mail: SECLOCK@IX NETCOM.COM
Sidney Schwartz Pres.
David Schwartz VP
Jeffrey Schwartz VP
Product Categories: B E F G

Branches: Pompano Beach FL
800-562-5720 800-246-9115

Security Plus Inc.

3612 N. 16th St.
Phoenix, AZ 85016
800-426-0200, 602-234-3883
Fax: 602-234-3882
Steven E. Marcou
Theo G. Nielson Sales Mgr.
Product Categories: B C D E F G H
See ad on page 145

Security Resources Inc.

PO Box 15532
Pensacola, FL 32514
888-801-2003, 850-476-2799
Fax: 850-476-7410
Web: www.techtrainproductions.com
Steve Young
Product Categories: C D G

Sentry Security Fasteners Inc.

P.O. Box 10165
Peoria, IL 61612
309-693-2800
Fax: 309-693-2872 800-693-2872
Thomas E. Ferre Pres., Stephen P. Cramer VP
Product Categories: F G

Septon Inc.

P.O. Box 9
Malden-On-Hudson, NY 12453
800-537-8752, 914-246-0638
Fax: 914-246-3416
Richard Septon Pres.
Ethel Wynne Secretary
Product Categories: B C F G

Serrubec Inc.

2073 Chartier Ave.
Dorval Quebec, Canada H9P 1H3
800-361-0243, 514-631-6791
Fax: 514-631-0494
E Mail: SERRUBEC@SYMPATICO.CA
Joseph Mastro VP
A. Huns Controller
S. Lecavalier Sales Coord.
Product Categories: A B C D E F G H

Shield Supply & Services Ltd.

Unit 17-1391 St. James St.
Winnipeg Man., Canada R3H 0Z1
204-774-1921
Fax: 204-774-5627
Shawn McIntosh President
Ian Wiechman S.T.
Product Categories: A B C D E F G H

ShurLok Key Storage

2720 NE 115th St.
Seattle, WA 98125
800-525-0954, 206-362-3290
Fax: 206-362-3290
E Mail: info@ShurLok-Products.com
Web: www.ShurLok-Products.com
Product Categories: F

Silver Sales

12190 Hampton Greens Ct.
Ft. Myers, FL 33913
800-258-5625, 941-561-9366
Fax: 941-561-9368
E Mail: mail@silversalesusa.com
Web: www.silversalesusa.com
Judee Silver Pres.
Bill Silver VP, David Silver VP Sales
Product Categories: H E
See ad on page 6
Branches: Plano TX
800-258-5625

Slide Lock Tool Co. Inc. Attn: Z-Tool Division

1166 Topside Rd.
Louisville, TN 37777
800-336-8812, 865-577-8470
Fax: 865-577-5936
Scott Selby
Product Categories: C G
See ad on page 101

Southern Lock & Supply Co.

P.O. Box 1980
Pinellas Park, FL 33780-1980
800-282-2837, 727-541-5536
Fax: 800-447-2299
E Mail: sales@southernlock.com
Web: www.southernlock.com
Marvin Cutson CEO
Davie Matthies President
Ed Pageau VP Sales
Product Categories: A B C D E F G
See ad on page 103

Branches: Pompano Beach FL
888-780-6071
Charlotte NC
888-517-9145
Atlanta GA
877-217-9396

Space Age Locksmith Supplies Inc.

138 W. Beresford Ave. Suite D
Deland, FL 32720
800-247-7942, 904-734-3113
Fax: 904-734-0559
John Millan Pres.
Product Categories: C F

Stainless Steel Products

101-20 DuPont St.
Plainview, NY 11803
516-349-8575
Fax: 516-349-8576
Ralph Rosenbaum

Standard Wholesale Hardware Inc.

42 Ludlow St
New York, NY 10002
800-543-5625, 212-353-0450
Fax: 212-420-9892

Stone & Berg Wholesale Locksmith Supply

99 Stafford St.
Worcester, MA 01603
800-225-7405, 508-753-3551
Fax: 800-535-5625
Web: www.stoneandberg.com
Jennie Berg Pagano Pres. CEO
Ed Niejadlik Controller
Rick Brown GM
Product Categories: B C D E F G H

Strauss Lock Co. Inc.

4663 121st
Urbandale, IA 50323
800-532-4107, 515-276-7030
Fax: 515-276-7031
Dan Swift Pres.
Todd Ferris Sales Mgr.
Product Categories: F

Taylor Security & Lock Co. Inc.

8585 Atlas Dr.
Gaithersburg, MD 20877-4186
800-676-7670, 301-948-7670
Fax: 301-948-1029
E Mail: sales@locks.net
Web: www.locks.net
Joel Taylor Pres.
Richard Hageman Sales Mgr.

Chris Gresh Operations Mgr.
Product Categories: B D E F G H

The Locksmith Store
1229 E. Algonquin Rd. Unit E
Arlington Heights, IL 60005
Tom Swiderek

Timemaster Inc.
127 SE 29th St.
Topeka, KS 66605
888-798-8464
Fax: 800-798-TIME (8463)
E Mail: TIMSTR@AOL.COM
Web: www.TIME-MASTER.COM
Dan Graffeo
Product Categories: C E F G H

Top Notch Distributors
80 Fourth St
Honesdale, PA 18431
800-233-4210, 570-253-LOCK (5625)
Fax: 800-854-4146
E Mail: topnotch@ptd.net
Web: www.4topnotch.com
Product Categories: B F
Branches: Carson City NV
800-722-4210 702-885-0440
Fax: 800-248-3620
St. Louis MO
800-211-4607, Fax: 800-211-4608

Turn 10 Wholesale Service
P.O. Box 746
Marietta, OH 45750
800-848-9790, 740-374-5734
Fax: 800-391-4553
David Miller Sales
Maribeth Browne Cust. Svc.
Product Categories: H
See ad on page 108
Branches: Philadelphia PA.

Tweeds Security Hardware Wholesale
601 Elm Ave.
Portsmouth, VA 23704
800-544-4482, 757-399-2180
Fax: 757-399-1636
E Mail: TWEEDSLOCK@AOL.COM
Ernest F. Floyd Jr. Pres.
Gary Waterman VP/Sales Dept.
Donald Kuebler Sales Mgr.
Product Categories: A B C E F G H D

U.S. Lock Corp.
77 Rodeo Dr.
Brentwood, NY 11717
800-925-5000, 631-243-3000
Fax: 631-243-0390
Web: www.uslock.org
Gene Merber Pres., Geoffrey Meyer VP
Product Categories: A B C D E F G H
Branches: Jacksonville FL, 904-783-3232
Jeffersontown KY, 502-493-0212
Ontario CA, 909-673-0563
Charlotte NC, 704-334-0333
Dallas TX, 214-351-3747

Ultra Hardware Products
1777 Hylton Rd.
Pennsauken, NJ 08110
609-663-5050
Fax: 609-663-1743
Karen Felix

Ultra Security
17560 Matinal Drive
San Diego, CA 92127
800-698-7477, 858-485-0698
Fax: 858-485-0476
Renee Ulaszek
Product Categories: B F G H

Wacker Hardware
1025 W. Jackson Blvd.
Chicago, IL 60607
800-956-3343, 312-733-6070
Fax: 312-733-7001
E Mail: wackerhardware@aol.com
Michael Chagdes Pres.
Ed Szefc GM
Kyle Noggle Sales Mgr.
Product Categories: B D E F G

Wadsworth White Inc.
4220 Steve Reynolds Blvd. Suite. 10
Norcross, GA 30093-3322
800-717-8184, 770-717-8505
Fax: 800-717-8227
Joe White Sales
Brenda Langston Cust. Svc.
Don Harris Cust. Svc.
Product Categories: A B E F

WEDGECO International
P.O. Box 50250
Bellevue, WA 98015
800-452-2304
Fax: 425-646-3569
E Mail: brokenkey@brokenkey.com
Web: www.brokenkey.com
Doug Kimzey Pres.
Product Categories: G
Branches: Bellevue WA
800-452-2304 425-646-3569 FAX

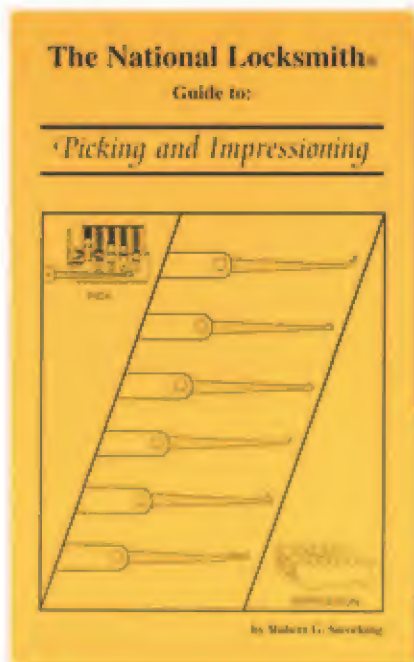

Picking & Impressioning

Here is the most complete book ever published on picking and impressioning locks! You will have everything you need to know about how to open almost every kind of lock that can be picked.

CLICK HERE TO LEARN MORE



#PI

December 2000 • 77

Westguard Inc.

P.O. Box 616
 Twinsburg, OH 44087
 888-699-9378, 330-963-6116
 Fax: 330-425-1834
 E Mail: westguard@westguard-inc.com
 Web: www.westguard-inc.com
 Robert Fox
Product Categories: A E F

Wholesale 4 Inc.

706 SE Grand Ave.
 Portland, OR 97214
 800-547-0921, 503-238-8605
 Fax: 503-8139290
 Nancy Moore Mgr.
 Bill Wolfe Sales
 Roger Cox Sales
Product Categories: B C D E F G H

Wholesale Cylinder Supply

2301 S. Cline # 212
 Schererville, IN 46375
 877-864-8809, 219-864-8879
 Fax: 219-864-8879
 E Mail: roy-miller@ameritech.net
 Web: www.wcslock.com
 Roy Miller
Product Categories: B F G

Wilco Supply

P.O. Box 3047
 Oakland, CA 94609-1597
 800-745-5450, 510-652-8522
 Fax: 510-653-5397
 E Mail: sales@wilcosupply.com
 Web: www.wilcosupply.com
 H.D. Williams Pres.
 Robert D. Williams VP/Oper. Mgr.
 Jonathan Clarner Sec./Treas.
Product Categories: A B C D E F G H

Worldwide Lock Supply Inc.

5950 Kester Ave.
 Van Nuys, CA 91411
 800-729-5444, 818-781-9999
 Fax: 818-781-8171
 Ellen Johnston Pres.
 Dave Cox, Purchasing
 Peter Levy Sales Manager
Product Categories: B C D E F G H

Yohar Supply

616 Cleveland St.
 Elyria, OH 44035
 216-366-5504
 Lloyd Lopez

Zipf Lock Co.

830 Harmon Ave.
 Columbus, OH 43223
 800-848-1577, 614-228-3507
 Fax: 800-228-6320
 E Mail: ZIPFLOCKCO@AOL.COM
 Web: www.ZIPFLOCKCO.com
 Richard Zipf
Product Categories: B C D E F G
 See ad on page 158



Safe Opening Articles

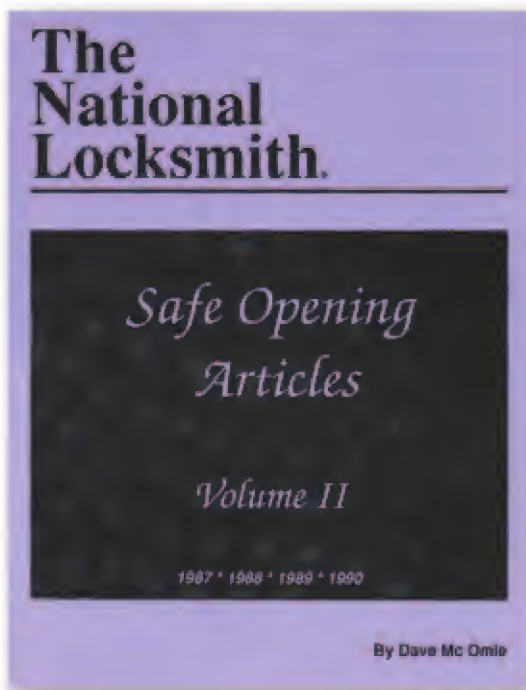

Dave McOmie's original articles from when he first started writing for The National Locksmith are reprinted in this book.

CLICK HERE TO LEARN MORE



#SA - 2

Modern Safe Locks

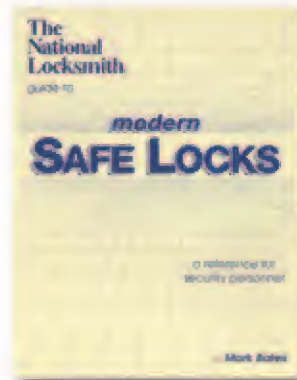

CLICK HERE TO LEARN MORE



#MSL - 1

DISTRIBUTORS

DISTRIBUTORS BY STATE

ALABAMA

Brook's Lock & Supply Inc.

Decatur
800-292-5008, 205-353-2596
Fax: 205-353-8260

Coast Safe & Lock

Mobile
334-479-5264
Fax: 334-471-6967

ARIZONA

Hawley Lock Supply

Phoenix
800-398-2458
Fax: 602-592-0105

Security Plus Inc.

Phoenix
800-426-0200, 602-234-3883
Fax: 602-234-3882

CALIFORNIA

Access Hardware Supply

San Leandro
800-348-2263, 510-483-5000
Fax: 800-435-8233

Automatic Gate Wholesalers

Redwood City
800-238-2301, 650-365-4340
Fax: 800-438-2301

Clark Security Products

San Diego
800-854-2088, 619-505-1950
Fax: 619-974-5290

DiMark International Inc.

Santa Maria
800-235-2435, 805-922-1182
Fax: 805-928-8034

DRK Specialties Keyrings Key Blanks & Things

Tracy
800-654-1850, 209-832-4100
Fax: 888-588-0667

Encon Electronics

Hayward
800-782-5598, 510-782-5598
Fax: 510-782-4290

Key Supply

San Francisco
415-626-2526, Fax: 415-626-4598

LDM Enterprises Inc.

Agoura
800-451-5950
Fax: 818-706-8560

LV Sales Inc.

Los Angeles
800-894-keys, 323-661-4746
Fax: 323-661-1314

Major Lock Supply

Fullerton
714-447-8363
Fax: 714-447-8393

National Auto Lock Service Inc.

San Bruno
800-954-5454, 415-757-0700
Fax: 415-757-9200

Orion Pacific Trading Company

Irvine
949-830-2003
Fax: 949-830-5668

Pride Barco Lock Company

Santa Barbara
800-578-1816, 805-965-8819
Fax: 805-965-2535

R & H Wholesale Supply Inc.

San Francisco
415-863-0404
Fax: 415-863-7046

R.B. Enterprises

Coarsegold
209-642-2710
Fax: 209-642-2699

Rininger Lock & Supply

Lemon Grove
619-463-0170
Fax: 619-697-2590

Robert Skeels & Company

Compton
800-734-4539, 310-639-7240
Fax: 310-639-7569

Safe & Secure

Culver City

Safe Superstore

Mira Loma

Ultra Security

San Diego
800-698-7477, 858-485-0698
Fax: 858-485-0476

Wilco Supply

Oakland
800-745-5450, 510-652-8522
Fax: 510-653-5397

Worldwide Lock Supply Inc.

Van Nuys
800-729-5444, 818-781-9999
Fax: 818-781-8171

CANADA

Access Safe & Supply Ltd.

Mississauga Ont.
800-268-9033, 905-795-9802
Fax: 905-795-9804

Agences W. Pelletier (1980) Inc.

Montreal Quebec
800-363-6700, 514-276-6700
Fax: 514-276-9413

Associated Lock & Supply

Port Coquitlam BC
800-668-7161, 604-942-5625
Fax: 604-942-3761

Cypress Security Products Ltd.

Calgary Alberta
800-561-1967, 403-250-1967
Fax: 403-250-1969

DL Services

Cambridge ONT
877-326-5625, 519-653-2538
Fax: 519-653-9539

Enixus Trade Ltd.

St. Catharines Ont.
905-682-3086
Fax: 905-682-3086

Hardinge Bros. Limited

Markham Ontario
905-470-8844
Fax: 905-470-2767

Hardware Agencies Ltd.

Toronto Ont.
800-268-6741, 416-462-1919
Fax: 416-462-1922

Jack Stearman Ltd.

Vancouver B.C.
604-872-8415
Fax: 604-875-9174

Jo-Van Distributors Inc.

Scarborough Ont.
888-752-7210, 416-752-7210
Fax: 888-752-3845

JW Benton Ltd.

Vancouver BC

McGregor Hardware Distribution Ltd.

Vancouver BC
800-663-5625, 604-253-7785
Fax: 604-253-7676

Security House Padlock Distributors

Concord Ontario
888-PADLOCKS "Canada wide"
905-669-5300
Fax: 905-660-6313

Serrubec Inc.

Dorval Quebec
800-361-0243
514-631-6791
Fax: 514-631-0494

Shield Supply & Services Ltd.

Winnipeg Man.
204-774-1921
Fax: 204-774-5627

COLORADO

City Lock & Safe

Boulder
303-444-4407
Fax: 303-442-8380

HMC Int'l Div. Inc.

Littleton
800-848-4912 ext. 4452
303-794-2510
Fax: 303-794-3703

Intermountain Lock & Supply

Denver
800-323-8046
303-698-1898
Fax: 303-698-2094

CONNECTICUT

Orchard Lock Distributors Inc.

Hamden
800-233-2146
203-865-8106
Fax: 203-624-4083

DISTRICT OF COLUMBIA

Blaydes Industries Inc.

Washington
800-424-2650
202-832-7100
Fax: 202-832-1359

Door Closer Service Co. Inc.

Washington

FLORDIA

Atlantic Lock & Key

Hallandale
954-966-9862
Fax: 954-962-1202

Blue Dog Key Company

Altamonte Springs
888-633-2526

Cisa Erupean Style Locks and Padlocks

Miami
305-716-8393
Fax: 305-716-8394

J.S.A. International Inc

Sunrise
954-741-3111
Fax: 310-534-1084

Key Mart Inc.

Stuart
800-228-7755
561-283-8029
Fax: 561-220-7920

Locks Co.

N. Miami
800-288-0801
305-949-0700
Fax: 305-949-3619

MasterLink Security Products

Lauderdale Lakes
954-581-2002
Fax: 954-581-9363

Security Resources Inc.

Pensacola
888-801-2003
850-476-2799
Fax: 850-476-7410

Silver Sales

Ft. Myers
800-258-5625
941-561-9366
Fax: 941-561-9368

Southern Lock & Supply Co.

Pinellas Park
800-282-2837
727-541-5536
Fax: 800-447-2299

Space Age Locksmith Supplies Inc.

Deland
800-247-7942
904-734-3113
Fax: 904-734-0559

GEORGIA

Great Southern Security

Villa Rica
770-830-7999

Safe Depot

College Park
877-723-3001
658-337-0010
Fax: 678-337-0014

Wadsworth White Inc.

Norcross
800-717-8184
770-717-8505
Fax: 800-717-8227

Ask Dave

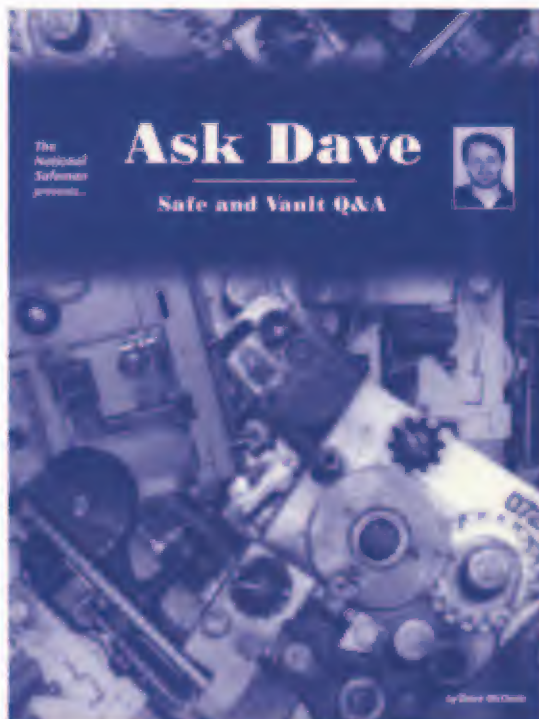

You asked. He answered. This is safe and vault Q&A with an attitude.

[CLICK HERE TO LEARN MORE](#)



#AD - 1

DISTRIBUTORS by STATE

HAWAII

Island Pacific Distributors Inc.

Honolulu
808-955-1126
Fax: 808-946-6480

IOWA

Strauss Lock Co. Inc.

Urbandale
800-532-4107
515-276-7030
Fax: 515-276-7031

ILLINOIS

Anderson Lock Co.

Des Plaines
800-323-5625
847-296-1157
Fax: 847-296-9259

AutoSmart Advisor

Streamwood
630-837-2044
Fax: 630-837-1210

Brady Office Machine Security

Chicago
800-326-8349
773-779-8349
Fax: 773-779-9712

Ewert Wholesale Hardware Inc.

Alsip
800-451-0200
708-597-0059
Fax: 708-597-0881

Express Hardware

Barrington
800-323-7447
847-381-9430
Fax: 847-381-7199

InstaCode 200 I

Streamwood
630-837-2044
Fax: 630-837-1210

Locksmith Dispatcher 2000

Streamwood
630-837-2044
Fax: 630-837-1210

Locksmith Store Inc., The

Arlington Heights
847-364-5111
Fax: 847-364-5125

MD Wholesale Hardware

Wheeling
800-345-7116
847-541-0010
Fax: 847-541-0020

National Locksmith, The

Streamwood
630-837-2044
Fax: 630-837-1210

Richardson Electronics Ltd.

La Fox
800-348-5580
630-208-2200
Fax: 630-208-2550

Sentry Security Fasteners Inc.

Peoria
309-693-2800
Fax: 309-693-2872 800-693-2872

The Locksmith Store

Arlington Heights
847-364-5111
Fax: 847-364-5125

Wacker Hardware

Chicago
800-956-3343
312-733-6070
Fax: 312-733-7001

INDIANA

Charman Enterprises

Eaton
800-247-6324
Fax: 800-647-8449

Wholesale Cylinder Supply

Schererville
877-864-8809
219-864-8879
Fax: 219-864-8879

KANSAS

Timemaster Inc.

Topeka
888-798-8464
Fax: 800-798-TIME (8463)

KENTUCKY

Lockmasters Inc.

Nicholasville
800-654-0637
606-885-6041
Fax: 606-885-7093

Martco

Louisville
800-233-7769
502-635-1600
Fax: 502-637-6430

MBA USA, Inc.

Nicholasville
888-622-5495
606-887-0496
Fax: 606-887-9491

MASSACHUSETTS

Boyle & Chase Inc.

Hingham
800-325-2530
781-337-3904
Fax: 800-205-3500

Commonwealth Lock Co.

Cambridge
800-442-7009
617-876-3301
Fax: 617-661-3168

Direct Security Supply Inc.

Boston
800-252-5757
617-787-5200
Fax: 800-452-8600

Dugmore and Duncan

Hingham
888-384-6673
Fax: 888-329-3846

Lyn/Lad Truck Equipment Div of Lyn/Ladder

Lynn
800-225-2510

New England Door Closer Inc.

West Springfield
800-628-1071
413-733-7889
Fax: 413-731-8368

O'Brien Bros. Inc.

W. Springfield
800-343-0949
413-734-7121
Fax: 413-737-1642

Pasek Corp.

So. Boston
800-628-2822
617-269-7110
Fax: 617-269-0547 or 800-262-0547

R.A. Graham Co. Inc.

Worcester
800-333-3933
508-755-5815
Fax: 888-755-6584

Security Lock Distributors

Needham Heights
800-847-5625
781-444-1155
Fax: 800-878-6400

Stone & Berg Wholesale Locksmith Supply

Worcester
800-225-7405
508-753-3551
Fax: 800-535-5625

MARYLAND

H & H Lock & Security Wholesalers

Gaithersburg
800-772-9811
301-948-1996
Fax: 301-948-5265

Maryland Security Distributors

Glen Burnie
800-390-8889
410-760-5625

Pimlico Key Service Inc.

Baltimore
800-638-3815
410-367-7400
Fax: 410-367-7319

Taylor Security & Lock Co. Inc.

Gaithersburg
800-676-7670
301-948-7670
Fax: 301-948-1029

MICHIGAN

Anchor Safe Co.

Warren
800-541-8050
810-755-3570
Fax: 810-755-1760

Detroit Mini Safe

Carleton

Gil-Ray Tools Inc.

Bay City
517-892-6870
Fax: 517-892-6870

H.S. & S. Wholesale Dist. of Lock Hdwe.

Detroit
800-521-2202
313-342-6777
Fax: 313-342-7580

JLM Wholesale Inc.

Oxford
800-522-2940
248-628-6440
Fax: 800-782-1160

Key Sales & Supply Co.

Detroit
800-445-KEYS (5397)
313-931-7720
Fax: 313-931-7758

Metro Safe Co. Inc.

Madison Heights
800-541-8050
810-585-7230
Fax: 810-755-1760

MINNESOTA

Doyle Security Products

Minneapolis
800-333-6953
612-521-6226
Fax: 612-521-0166

E.L. Reinhardt Company

Vadnais Heights
800-328-1311
651-481-0566
Fax: 651-481-0166

Lion Security Products

Minneapolis
612-789-7657
Fax: 612-789-0706

PLS Distribution Group

Vadnais Heights
612-481-0566

MISSOURI

Foley Belsaw Co. Locksmith Division

Kansas City
800-821-3452
816-483-2700
Fax: 816-483-5010

Intek Global Corp. (Midland Land Mobil Radio)

Kansas City
800-669-4567
816-241-8400
Fax: 816-920-1144

NSO One Year Membership



To make big profits in safe work with no hassles...you need information!

[CLICK HERE TO LEARN MORE](#)



DISTRIBUTORS by STATE

MISSOURI

(CONTINUED)

Intek Golbal Corp.

Kansas City

Midwest Wholesale Hardware

Kansas City
800-821-8527
816-241-5663
Fax: 800-621-6581

Monday Security Corp.

Webster Grove
314-962-8787
Fax: 314-9620791

Security Equipment Supply

Earth City
800-325-0221
314-298-8930
Fax: 314-298-8962

NORTH CAROLINA

Hardware Suppliers of America Inc.

Winterville
800-334-5625
919-355-9495

McManus Locksmith Supply Inc.

Charlotte
NC 800-432-6342 SC 800-438-6567
704-333-9112 or 704-333-0556
Fax: 704-332-8664

Preferred Locksmith Service

Salsbury

NEBRASKA

Omaha Wholesale Hardware

Omaha
800-238-4566, 402-444-1673
Fax: 800-538-4566

NEW JERSEY

Accredited Lock Supply Co.

Secaucus
800-652-2835, 201-865-5015
Fax: 201-865-5031

Ace Lock & Security Supply

Union
800-223-5625, 908-688-7666
Fax: 908-688-2442

Ambassador Wholesale Safe Distributors

Lake Hiawatha
800-999-5510, 973-263-3768
Fax: 973-402-1447

ASLA Distributing

Clinton
516-766-2863
Fax: 516-766-2863

Bell's Security Sales Inc.

Bloomfield
800-772-2266, 973-743-3709
Fax: 973-743-6357

Craftmaster Hardware Co. Inc.

Hackensack
800-221-3212, 201-646-9355
Fax: 201-646-0181

Garden State Hardware Wholesalers

Planfield
800-544-0616, 908-753-1343
Fax: 908-753-2040

Kramer Boys Locksmith Supply

Trenton
800-222-2692, 609-586-0642
Fax: 609-586-0512

Le'Clasp

Phillipsburg
908-213-9233
Fax: 908-454-5394

Majestic Lock

Hackensack

Monaco Lock Company Inc.

Jersey City
800-526-6094, 201-659-7969
Fax: 201-659-7970

Northeast Lock Corp.

Clifton
800-524-2575, 201-777-7509
Fax: 800-524-2576

Ultra Hardware Products

Pennsauken
609-663-5050
Fax: 609-663-1743

NEW YORK

ADI

Syosset
516-921-6704
Fax: 516-921-8118

Alarm Systems Distributors

Albany
518-463-4000
Fax: 518-463-4628

Avco Key Supply

Northport
800-332-5397, 516-261-6453
Fax: 800-329-5397

Empire Security Supplies

Pt. Jefferson Station
516-928-1919
Fax: 516-928-4745

Fradon Lock Co. Inc.

Syracuse
800-447-0591, 315-472-6988
Fax: 315-472-0958

Hahn & Schaffner Inc.

Bolivar
888-645-8696
716-928-2850
Fax: 716-928-2852

J. Nathan Hardware Specialties Inc.

Rochester
800-634-2580, 716-325-3330
Fax: 716-325-7196

Keys Plus Distributing

Tonawanda
800-644-5397, 716-743-0220

Kolson Inc.

Great Neck
800-783-1335, 516-487-1224
Fax: 516-487-1231

Mayflower Sales Co. Inc.

Brooklyn
800-221-2052, 718-622-8785
Fax: 718-789-8346

Maziuk Wholesale Distributors

Syracuse
800-777-5945, 315-474-3959
Fax: 315-472-3111

New York Locksmith Supply Co. Inc.

New York
212-737-0178, 914-328-1919
Fax: 212-988-9192

Progressive Hardware Inc.

East Northport

Richmond Industrial Supplies

Staten Island
800-462-9997, 718-448-2100
Fax: 718-981-5665

Secure Car Enterprises

Farmingdale
516-293-8030
Fax: 516-293-0690

Secure Industries Inc.

Hicksville
800-999-2534, 516-433-0033
Fax: 516-433-8804

Septon Inc.

Malden-On-Hudson
800-537-8752, 914-246-0638
Fax: 914-246-3416

Stainless Steel Products

Plainview
516-349-8575
Fax: 516-349-8576

Standard Wholesale Hardware Inc.

New York
800-543-5625, 212-353-0450
Fax: 212-420-9892

U.S. Lock Corp.

Brentwood
800-925-5000, 631-243-3000
Fax: 631-243-0390

OHIO

Akron Hardware Consultants

Akron
800-321-9602, 330-644-7167
Fax: 800-328-6070

Allied Locksmith Supply

Youngstown
800-544-2102, 330-726-0866
Fax: 330-726-0865

Curtis Industries A Barnes Distribution Company

Cleveland
800-555-5397
Fax: 800-867-6020

Fortress Safe & Lock Cincinnati

800-562-0295, 513-772-4392
Fax: 513-326-5983

Key Products

Columbus
614-876-7704
Fax: 614-876-1437

Ohio Travel Bag Mfg. Co.

Solon
800-800-1941, 440-498-1955
Fax: 440-498-9811

RHS Security Hardware

Akron
880-848-3348, 330-753-3257
Fax: 303-848-3338

Safer Image

Columbus
614-447-0000
Fax: 614-412-0008

Turn 10 Wholesale Service

Marietta
800-848-9790, 740-374-5734
Fax: 800-391-4553

Westguard Inc.

Twinsburg
888-699-9378, 330-963-6116
Fax: 330-425-1834

Yohar Supply

Elyria
216-366-5504

Zipf Lock Co.

Columbus
800-848-1577, 614-228-3507
Fax: 800-228-6320

OKLAHOMA

Jim Ripley's Services Inc.

Claremore
918-341-1077

OREGON

Berg Wholesale Inc.

Portland
800-243-8887, 503-220-0000
Fax: 503-228-9410

H.E. Mitchell Co.

Portland
800-626-5625, 503-236-9444
Fax: 503-238-5715

Northwest Lock & Supply Co.

Albany
800-359-9425, 541-967-2749
Fax: 541-928-9338

Wholesale 4 Inc.

Portland
800-547-0921, 503-238-8605
Fax: 503-8139290

PENNSYLVANIA

Ace Lock The Security People

Pittsburgh
800-824-7712, 412-363-3328
Fax: 412-363-7540

AmoraTech Inc.

Shermans Dale
717-582-3819

Fax: 717-582-7549

Andrew's Wholesale Lock Supply

Lebanon
800-544-0519, 717-274-8733
Fax: 717-274-8659

Fried Bros. Inc.

Philadelphia
800-523-2924, 215-627-3205
Fax: 215-592-1255

Independent Hardware Inc.

Philadelphia
800-346-9464, 215-925-5306
Fax: 215-922-6552

Keys Wholesale Distributors Inc.

Drexel Hill
800-292-5397, 610-626-4787
Fax: 610-626-4189

M. Shepse Co. Div. American Bionics

Pittsburgh
800-666-6007, 412-381-4900
Fax: 412-381-5122

Midwest Safe Distributors

Philadelphia
800-713-7233, 215-492-2024
Fax: 800-355-1195 or 215-492-2025

Top Notch Distributors

Honesdale
800-233-4210, 570-253-LOCK (5625)
Fax: 800-854-4146

Dave McOmie on Vault Doors Vol. 1 & 2

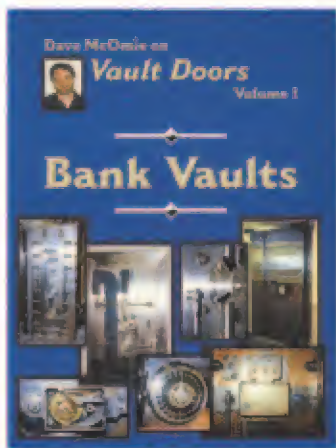

CLICK HERE TO LEARN MORE



#VD - 1, VD - 2

Ask Dave



CLICK HERE TO LEARN MORE



#AD - 1

December 2000 • 85

DISTRIBUTORS by STATE

Flat Rate Manual

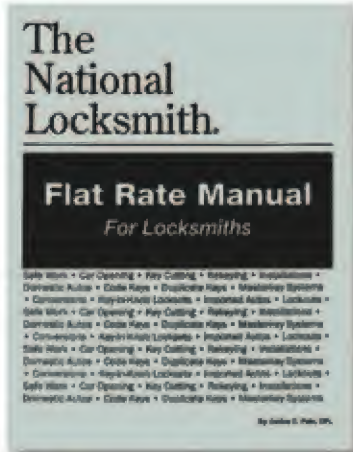

Now you can easily
"Price for Profit!"

CLICK HERE TO LEARN MORE



#FRM - 1

86 • The National Locksmith

RHODE ISLAND

Perry Blackburne Inc
Cumberland
800-556-7474, 401-725-7611

TENNESEE

McDonald Dash Locksmith Supply Inc.
Memphis
800-238-7541, 901-797-8000
Fax: 901-366-0005

Mid-South Locksmith Supply
Memphis
800-238-6166, 901-795-6987
Fax: 901-795-3475 888-795-3475

Safe Warehouse International
Knoxville
800-695-2815
Fax: 423-675-2850

Slide Lock Tool Co. Inc.
Attn: Z-Tool Division
Louisville
800-336-8812, 865-577-8470
Fax: 865-577-5936

TEXAS

Amos Lock & Key Supply Co.
Fort Worth
800-772-7432, 317-335-5397
Fax: 317-335-5399

Defiant Safe Co. Inc.
Dallas
800-225-2984, 972-243-3711
Fax: 972-241-7669

Fairway Supply Inc.
Dallas
800-776-3247
Fax: 214-352-4299

Hans Johnsen Co.
Dallas
888-879-1500, 214-879-1550
Fax: 214-879-1530

Herbert Flake Co.
Houston
800-231-4105, 713-926-3200
Fax: 713-926-3399

Howard Sales Co.
El Paso
800-456-4625, 915-833-7733
Fax: 915-833-7770

International Distribution Network
Grapevine
817-421-5470
Fax: 817-421-5468

RA-Lock Company
Cedar Hill
800-777-6310, 972-775-6301
Fax: 972-775-6316

S.D.I. (Security Distributos, Inc)
Dallas
214-879-1563
Fax: 214-879-1525

VIRGINIA

American Lock & Key Co.
Richmond
800-995-6247, 804-282-6060
Fax: 804-282-1007

Colonial Lock Supply Co. Inc.
Newington
800-732-9117, 703-550-8558
Fax: 703-550-8857

Safemasters Company Inc.
Alexandria
800-633-9977, 703-256-6402
Fax: 703-750-1814

Tweeds Security Hardware Wholesale
Portsmouth
800-544-4482, 757-399-2180
Fax: 757-399-1636

WASHINGTON

KDL Hardware Supply
Seattle
800-524-9305, 206-682-7383
Fax: 800-524-9305

Padlocks4less.com
Seattle
206-972-4557
Fax: 206-523-9876

Power Company, The
Seattle
206-624-5090
Fax: 206-284-1138

S & J Products & Services
Yakima
800-735-1797, 509-575-1797
Fax: 509-575-1875

ShurLok Key Storage
Seattle
800-525-0954, 206-362-3290
Fax: 206-362-3290

WEDGECO International
Bellevue
800-452-2304
Fax: 425-646-3569

WISCONSIN

Door Hardware Distributors Inc.
Milwaukee
800-829-8905, 414-291-5687
Fax: 414-291-5685

Fastrack Hardware Inc.
Menomonee Falls
800-458-8707, 262-781-8118
Fax: 800-667-8701 or 262-781-1162



DISTRIBUTORS BY PRODUCT

ALARMS

Access Hardware Supply

CA
800-348-2263, 510-483-5000
Fax: 800-435-8233
E Mail: JREAM@LOCKS.com
Web: www.accesshardware.com

Accredited Lock Supply Co.

NJ
800-652-2835, 201-865-5015
Fax: 201-865-5031
E Mail: mail@accllock.com
Web: www.accllock.com

Ace Lock The Security People

PA
800-824-7712, 412-363-3328
Fax: 412-363-7540
E Mail: info@acelockinc.com

Ace Lock & Security Supply

NJ
800-223-5625, 908-688-7666
Fax: 908-688-2442
E Mail: acelock@acelock.com
Web: www.acelock.com

Agences W. Pelletier (1980) Inc.

Canada
800-363-6700, 514-276-6700
Fax: 514-276-9413
E Mail: sales@apa-pelletier.com
Web: www.apa-pelletier.com

Bell's Security Sales Inc.

NJ
800-772-2266, 973-743-3709
Fax: 973-743-6357

Blaydes Industries Inc.

DC
800-424-2650, 202-832-7100
Fax: 202-832-1359
E Mail: blaydesind@msn.com

Brook's Lock & Supply Inc.

AL
800-292-5008, 205-353-2596
Fax: 205-353-8260
E Mail: brooksloc@brookslock.com
Web: www.brookslock.com

E.L. Reinhardt Company

MN
800-328-1311, 651-481-0566
Fax: 651-481-0166
E Mail: elreinhard+@uswest.net
Web: www.plsgroup.com

Empire Security Supplies

NY
516-928-1919
Fax: 516-928-4745

Fairway Supply Inc.

TX
800-776-3247
Fax: 214-352-4299
E Mail: fairwayinc@aol.com

Fried Bros. Inc.

PA
800-523-2924, 215-627-3205
Fax: 215-592-1255
E Mail: fbisecurity@fbisecurity.com
Web: www.fbisecurity.com

Garden State Hardware Wholesalers

NJ
800-544-0616, 908-753-1343
Fax: 908-753-2040

H.E. Mitchell Co.

OR
800-626-5625, 503-236-9444
Fax: 503-238-5715

Hahn & Schaffner Inc.

NY
888-645-8696, 716-928-2850
Fax: 716-928-2852

Hardinge Bros. Limited

Canada
905-470-8844
Fax: 905-470-2767
E Mail: hardinge@accessv.com
Web: www.cansecure.com

Hardware Agencies Ltd.

Canada
800-268-6741, 416-462-1919
Fax: 416-462-1922
E Mail: sales@hardwareagencies.com

Intermountain Lock & Supply

CO
800-323-8046, 303-698-1898
Fax: 303-698-2094

Island Pacific Distributors Inc.

HI
808-955-1126
Fax: 808-946-6480

Jo-Van Distributors Inc.

CANADA
888-752-7210, 416-752-7210
Fax: 888-752-3845
E Mail: sales@jovanlock.com
Web: www.jovanlock.com

KDL Hardware Supply

WA
800-524-9305, 206-682-7383
Fax: 800-524-9305
E Mail: REX@ESKIMO.COM
Web: www.KDLLINK.COM

Key Sales & Supply Co.

MI
800-445-KEYS (5397)
313-931-7720
Fax: 313-931-7758

Kramer Boys Locksmith Supply

NJ
800-222-2692, 609-586-0642
Fax: 609-586-0512

LV Sales Inc.

CA
800-894-keys, 323-661-4746
Fax: 323-661-1314
E Mail: sales@lvsales.com
Web: www.lvsales.com

M. Shepse Co. Div. American Bionics

PA
800-666-6007, 412-381-4900
Fax: 412-381-5122

Martco

KY
800-233-7769, 502-635-1600
Fax: 502-637-6430
Web: www.martcoinc.com

Maryland Security Distributors

MD
800-390-8889, 410-760-5625

Maziuk Wholesale Distributors

NY
800-777-5945, 315-474-3959
Fax: 315-472-3111
E Mail: sales@mzkworld.com
Web: www.mzkworld.com

McDonald Dash Locksmith Supply Inc.

TN
800-238-7541, 901-797-8000
Fax: 901-366-0005
E Mail: JIMDT@AOL.COM

MD Wholesale Hardware

IL
800-345-7116, 847-541-0010
Fax: 847-541-0020
E Mail: info@mdhardware.com
Web: www.mdhardware.com

Omaha Wholesale Hardware

NE
800-238-4566, 402-444-1673
Fax: 800-538-4566

Pasek Corp.

MA
800-628-2822, 617-269-7110
Fax: 617-269-0547 or
800-262-0547
E Mail: PASEK@PASEK.COM

R & H Wholesale Supply Inc.

CA
415-863-0404
Fax: 415-863-7046

RHS Security Hardware

OH
880-848-3348
330-753-3257
Fax: 303-848-3338

Richardson Electronics Ltd.

IL
800-348-5580, 630-208-2200
Fax: 630-208-2550
Web: www.rell.com

S & J Products & Services

WA
800-735-1797, 509-575-1797
Fax: 509-575-1875

Safemasters Company Inc.

VA
800-633-9977, 703-256-6402
Fax: 703-750-1814
Web: www.safemasters.com

Security Equipment Supply

MO
800-325-0221, 314-298-8930
Fax: 314-298-8962

Serrubec Inc.

Canada
800-361-0243, 514-631-6791
Fax: 514-631-0494
E Mail: SERRUBEC@SYMPATICO.CA

Shield Supply & Services Ltd.

CANADA
204-774-1921
Fax: 204-774-5627

Southern Lock & Supply Co.

FL
800-282-2837, 727-541-5536
Fax: 800-447-2299
E Mail: sales@southernlock.com
Web: www.southernlock.com

Tweeds Security Hardware Wholesale

VA
800-544-4482, 757-399-2180
Fax: 757-399-1636
E Mail: tweedslock@aol.com

U.S. Lock Corp.

NY
800-925-5000, 631-243-3000
Fax: 631-243-0390
Web: www.uslock.org

Wadsworth White Inc.

GA
800-717-8184, 770-717-8505
Fax: 800-717-8227

Westguard Inc.

OH
888-699-9378, 330-963-6116
Fax: 330-425-1834
E Mail: westguard@westguard-inc.com
Web: www.westguard-inc.com

Wilco Supply

CA
800-745-5450, 510-652-8522
Fax: 510-653-5397
E Mail: sales@wilcosupply.com
Web: www.wilcosupply.com

ARCHITECTURAL HARDWARE

Access Hardware Supply

CA
800-348-2263, 510-483-5000
Fax: 800-435-8233
E Mail: JREAM@LOCKS.com
Web: www.accesshardware.com

Accredited Lock Supply Co.

NJ
800-652-2835, 201-865-5015
Fax: 201-865-5031
E Mail: mail@acclock.com
Web: www.acclock.com

Ace Lock The Security People

PA
800-824-7712, 412-363-3328
Fax: 412-363-7540
E Mail: info@acelockinc.com

Ace Lock & Security Supply

NJ

800-223-5625, 908-688-7666
Fax: 908-688-2442
E Mail: acelock@acelock.com
Web: www.acelock.com

Agences W. Pelletier (1980) Inc.

Canada
800-363-6700, 514-276-6700
Fax: 514-276-9413
E Mail: sales@apa-pelletier.com
Web: www.apa-pelletier.com

Akron Hardware Consultants

OH
800-321-9602, 330-644-7167
Fax: 800-328-6070
Web: www.akronhardware.com

American Lock & Key Co.

VA
800-995-6247, 804-282-6060
Fax: 804-282-1007

Amos Lock & Key Supply Co.

TX
800-772-7432, 317-335-5397
Fax: 317-335-5399

Anderson Lock Co.

IL
800-323-5625, 847-296-1157
Fax: 847-296-9259
E Mail: mail@andersonlock.com
Web: www.andersonlock.com

ASLA Distributing

NJ
516-766-2863
Fax: 516-766-2863
E Mail: dean@asla-
distributing.com
Web: www.asla-distributing.com

Bell's Security Sales Inc.

NJ
800-772-2266, 973-743-3709
Fax: 973-743-6357

Berg Wholesale Inc.

OR
800-243-8887, 503-220-0000
Fax: 503-228-9410

Blaydes Industries Inc.

DC
800-424-2650, 202-832-7100
Fax: 202-832-1359
E Mail: blaydesind@msn.com

Boyle & Chase Inc.

MA
800-325-2530, 781-337-3904
Fax: 800-205-3500
E Mail: sales@boyleandchase.com
Web: www.boyleandchase.com

Brook's Lock & Supply Inc.

AL
800-292-5008, 205-353-2596
Fax: 205-353-8260
E Mail:
brookslloc@brooksllock.com
Web: www.brooksllock.com

Brooks Wholesale

AL
800-292-5008
Fax: 205-353-8260
E Mail: brookslloc@tiger.net-
master.net
Web: www.brooksllock.com

City Lock & Safe

CO
303-444-4407
Fax: 303-442-8380
E Mail: Dougsco@aol.com

Clark Security Products

CA
800-854-2088, 619-505-1950
Fax: 619-974-5290
E Mail:
webmaster@clarksecurity.com
Web: www.clarksecurity.com

Colonial Lock Supply Co. Inc.

VA
800-732-9117, 703-550-8558
Fax: 703-550-8857

Commonwealth Lock Co.

MA
800-442-7009, 617-876-3301
Fax: 617-661-3168
E Mail: clc1936@aol.com
Web: www.commonwealth
lockco.bizonthe.net



Locksmith Dispatcher 2000

Controlled Service
dispatching software
specifically for
the locksmith!

CLICK HERE TO LEARN MORE



#DIS - 2000

December 2000 • 89

**ARCHITECTURAL
HARDWARE
(CONTINUED)**

**Craftmaster
Hardware Co. Inc.**

NJ
800-221-3212, 201-646-9355
Fax: 201-646-0181
E Mail: info@craftmaster.net
Web: www.craftmaster.net

**Cypress Security
Products Ltd.**

CANADA
800-561-1967, 403-250-1967
Fax: 403-250-1969

**Direct
Security
Supply Inc.**

MA
800-252-5757, 617-787-5200
Fax: 800-452-8600

DL Services

CANADA
877-326-5625, 519-653-2538
Fax: 519-653-9539

E Mail:
jimcushing@domsecurity.com
Web: www.domsecurity.com

**Door Closer
Service Co. Inc.**

DC
202-526-0505

**Door
Hardware
Distributors
Inc.**

WI
800-829-8905, 414-291-5687
Fax: 414-291-5685
E Mail: info@doorhardware.net
Web: www.doorhardware.net

**Doyle Security
Products**

MN
800-333-6953, 612-521-6226
Fax: 612-521-0166
Web: www.doylesecurity.com

Dugmore and Duncan

MA
888-384-6673
Fax: 888-329-3846
E Mail: sales@dugmore.com
Web: www.dugmore.com

**E.L. Reinhardt
Company**

MN
800-328-1311, 651-481-0566
Fax: 651-481-0166
E Mail: elreinhard@uswest.net
Web: www.plsgroup.com

**Empire Security
Supplies**

NY
516-928-1919
Fax: 516-928-4745

Enixus Trade Ltd.

CANADA
905-682-3086
Fax: 905-682-3086

**Ewert Wholesale
Hardware Inc.**

IL
800-451-0200, 708-597-0059
Fax: 708-597-0881

Express Hardware

IL
800-323-7447, 847-381-9430
Fax: 847-381-7199

Fairway Supply Inc.

TX
800-776-3247
Fax: 214-352-4299
E Mail: fairwayinc@aol.com

Fastrack Hardware Inc.

WI
800-458-8707, 262-781-8118
Fax: 800-667-8701 or
262-781-1162

Fortress Safe & Lock

OH
800-562-0295, 513-772-4392
Fax: 513-326-5983

Fradon Lock Co. Inc.

NY
800-447-0591, 315-472-6988
Fax: 315-472-0958
E Mail: fradonlock@aol.com

Fried Bros. Inc.

PA
800-523-2924, 215-627-3205
Fax: 215-592-1255
E Mail:
fbisecurity@fbisecurity.com
Web: www.fbisecurity.com

**Garden State
Hardware
Wholesalers**

NJ
800-544-0616, 908-753-1343
Fax: 908-753-2040

**H & H Lock &
Security Wholesalers**

MD
800-772-9811, 301-948-1996
Fax: 301-948-5265
E Mail: hhlock@erols.com
Web: www.hhlock.com

H.E. Mitchell Co.

OR
800-626-5625, 503-236-9444
Fax: 503-238-5715

**H.S. & S. Wholesale
Dist. of Lock Hdwe.**

MI
800-521-2202, 313-342-6777
Fax: 313-342-7580

Hahn & Schaffner Inc.

NY
888-645-8696, 716-928-2850
Fax: 716-928-2852

**Hans Johnsen
Co.**

TX
888-879-1500, 214-879-1550
Fax: 214-879-1530

E Mail: LOCKHJC@AOL.COM
Web: www.hjc.com

Hardinge Bros. Limited

Canada
905-470-8844
Fax: 905-470-2767
E Mail:
hardinge@accessv.com
Web: www.cansecure.com

Hardware Agencies Ltd.

Canada
800-268-6741, 416-462-1919
Fax: 416-462-1922
E Mail:
sales@hardwareagencies.com

**Hardware Suppliers
of America Inc.**

NC
800-334-5625, 919-355-9495

**Herbert
Flake Co.**

TX
800-231-4105, 713-926-3200
Fax: 713-926-3399
E Mail: DanF@hlflake.com
Web: www.hlflake.com

HMC Int'l Div. Inc.

CO
800-848-4912 ext. 4452
303-794-2510
Fax: 303-794-3703

Howard Sales Co.

TX
800-456-4625, 915-833-7733
Fax: 915-833-7770
E Mail: howard@whc.net
Web: www.howardsales.com

**Independent
Hardware Inc.**

PA
800-346-9464, 215-925-5306
Fax: 215-922-6552
E Mail: roommate4@aol.com

**Intermountain
Lock & Supply**

CO
800-323-8046, 303-698-1898
Fax: 303-698-2094

**Island Pacific
Distributors Inc.**

HI
808-955-1126
Fax: 808-946-6480

**J. Nathan
Hardware
Specialties Inc.**

NY
800-634-2580, 716-325-3330
Fax: 716-325-7196
E Mail: @jnathan.com
Web: www.jnathan.com

Jack Stearman Ltd

Canada
604-872-8415
Fax: 604-875-9174

**JLM
Wholesale Inc.**

MI

800-522-2940, 248-628-6440
Fax: 800-782-1160
E Mail: sales@jlmwholesale.com
Web: www.jlmwholesale.com

**Jo-Van
Distributors
Inc.**

CANADA
888-752-7210, 416-752-7210
Fax: 888-752-3845
E Mail: sales@jovanlock.com
Web: www.jovanlock.com

**KDL Hardware Supply
WA**

800-524-9305, 206-682-7383
Fax: 800-524-9305
E Mail: REX@ESKIMO.COM
Web: www.KDLLINK.COM

Key Mart Inc.

FL
800-228-7755, 561-283-8029
Fax: 561-220-7920

Key Sales & Supply Co.

MI
800-445-KEYS (5397)
313-931-7720
Fax: 313-931-7758

**Keys Wholesale
Distributors Inc.**

PA
800-292-5397, 610-626-4787
Fax: 610-626-4189

Kolson Inc.

NY
800-783-1335, 516-487-1224
Fax: 516-487-1231
E Mail: KOLSON@IDT.NET

**Kramer Boys
Locksmith Supply**

NJ
800-222-2692, 609-586-0642
Fax: 609-586-0512

Locks Co.

FL
800-288-0801, 305-949-0700
Fax: 305-949-3619
E Mail: LOCKSCO@GATE.NET
Web: www.LOCKSCO.COM

LV Sales Inc.

CA
800-894-keys, 323-661-4746
Fax: 323-661-1314
E Mail: sales@lvsales.com
Web: www.lvsales.com

**M. Shepse Co. Div.
American Bionics**

PA
800-666-6007, 412-381-4900
Fax: 412-381-5122

Major Lock Supply

CA
714-447-8363
Fax: 714-447-8393

**Maryland Security
Distributors**

MD
800-390-8889, 410-760-5625

**Mayflower
Sales Co. Inc.**

NY
800-221-2052, 718-622-8785
Fax: 718-789-8346
E Mail: pilgrim@mfsales.com
Web: www.mfsales.com

**Maziuk Wholesale
Distributors**

NY
800-777-5945, 315-474-3959
Fax: 315-472-3111
E Mail: sales@mzkworld
Web: www.mzkworld.com

**McDonald Dash
Locksmith Supply Inc.**

TN
800-238-7541, 901-797-8000
Fax: 901-366-0005
E Mail: JIMDT@AOL.COM

**McManus
Locksmith
Supply Inc.**

NC
NC 800-432-6342 SC 800-
438-6567, 704-333-9112 or
704-333-0556
Fax: 704-332-8664
E Mail: mclock@bellsouth.net

**MD Wholesale
Hardware**

IL
800-345-7116, 847-541-0010
Fax: 847-541-0020
E Mail:
info@mdhardware.com
Web: www.mdhardware.com

**Mid-South
Locksmith Supply**

TN
800-238-6166, 901-795-6987
Fax: 901-795-3475 or
888-795-3475
E Mail: midsouthlk@aol.com

**Midwest Wholesale
Hardware**

MO
800-821-8527, 816-241-5663
Fax: 800-621-6581
E Mail: HDWSales@
midwestwholesale.com

**Monaco Lock
Company Inc.**

NJ
800-526-6094, 201-659-7969
Fax: 201-659-7970
E Mail: monacolock@aol.com
Web: www.monacolock.com

**New England Door
Closer Inc.**

MA
800-628-1071, 413-733-7889
Fax: 413-731-8368
E Mail: nedc@worldnet.att.net

**Northwest Lock &
Supply Co.**

OR
800-359-9425, 541-967-2749
Fax: 541-928-9338

O'Brien Bros. Inc.

MA
800-343-0949, 413-734-7121
Fax: 413-737-1642

**Omaha Wholesale
Hardware.**

NE
800-238-4566, 402-444-1673
Fax: 800-538-4566

**Orchard Lock
Distributors Inc.**

CT
800-233-2146, 203-865-8106
Fax: 203-624-4083

Padlocks4less.com

WA
206-972-4557
Fax: 206-523-9876
E Mail: info@padlocks4less.com
Web: www.padlocks4less.com

Pasek Corp.

MA
800-628-2822, 617-269-7110
Fax: 617-269-0547 or
800-262-0547
E Mail: PASEK@PASEK.COM

**Pride Barco Lock
Company**

CA
800-578-1816, 805-965-8819
Fax: 805-965-2535
E Mail:
pride.barco@mindspring.com
Web:
http://mindspring.net/npride
.barco/

**R & H Wholesale
Supply Inc.**

CA
415-863-0404
Fax: 415-863-7046

R.A. Graham Co. Inc.

MA
800-333-3933, 508-755-5815
Fax: 888-755-6584

**RHS Security
Hardware**

OH
880-848-3348, 330-753-3257
Fax: 303-848-3338

**Richmond Industrial
Supplies**

NY
800-462-9997, 718-448-2100
Fax: 718-981-5665

**Rininger Lock
& Supply**

CA
619-463-0170
Fax: 619-697-2590
E Mail: rininger@electriciti.com
Web: www.electriciti.com/
rininger

**Robert Skeels
& Company**

CA
800-734-4539, 310-639-7240
Fax: 310-639-7569
Web: www.SKEELS.COM

Foreign & Domestic Auto Service

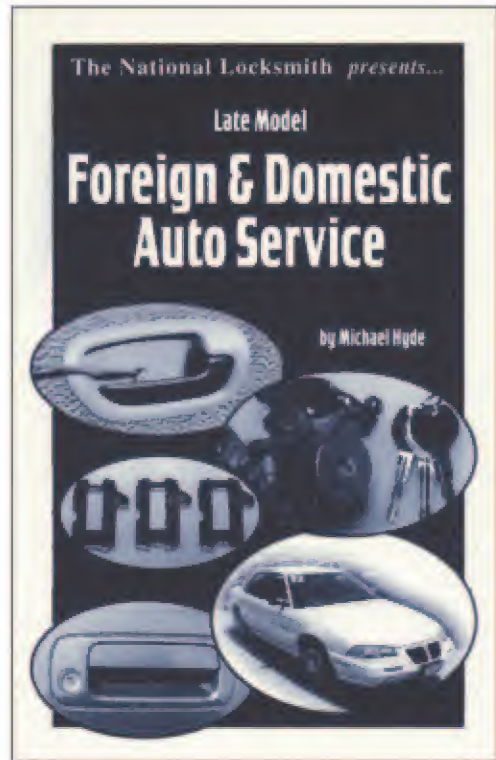

This book represents the best work of Automotive Locksmithing guru Michael Hyde, author of the famous AutoSmart.

CLICK HERE TO LEARN MORE



#FDAS - 1

DISTRIBUTORS by PRODUCT

**ARCHITECTURAL
 HARDWARE
 (CONTINUED)**

**S.D.I. (Security
 Distributors, Inc)**

TX
 214-879-1563
 Fax: 214-879-1525

**Safemasters
 Company Inc.**

VA
 800-633-9977, 703-256-6402
 Fax: 703-750-1814
 Web: www.safemasters.com

Secure Industries Inc.

NY
 800-999-2534, 516-433-0033
 Fax: 516-433-8804
 Web: www.secureindust.com

**Security House
 Padlock Distributors**

CANADA
 888-PADLOCKS "Canada
 wide", 905-669-5300
 Fax: 905-660-6313

**Security Lock
 Distributors**

MA
 800-847-5625, 781-444-1155
 Fax: 800-878-6400
 E Mail: SECLOCK@IX
 NETCOM.COM

Security Plus Inc.

AZ

800-426-0200, 602-234-3883
 Fax: 602-234-3882

Septon Inc.

NY
 800-537-8752, 914-246-0638
 Fax: 914-246-3416

Serrubec Inc.

Canada
 800-361-0243, 514-631-6791
 Fax: 514-631-0494
 E Mail: serrubec@sympatico.ca

**Shield Supply &
 Services Ltd.**

CANADA
 204-774-1921
 Fax: 204-774-5627

**Southern Lock &
 Supply Co.**

FL
 800-282-2837, 727-541-5536
 Fax: 800-447-2299
 E Mail: sales@southernlock.com
 Web: www.southernlock.com

**Stone & Berg Wholesale
 Locksmith Supply**

MA
 800-225-7405, 508-753-3551
 Fax: 800-535-5625
 Web: www.stoneandberg.com

**Taylor Security
 & Lock Co. Inc.**

MD
 800-676-7670, 301-948-7670
 Fax: 301-948-1029
 E Mail: sales@locks.net
 Web: www.locks.net

**Top Notch
 Distributors**

PA
 800-233-4210
 570-253-LOCK (5625)
 Fax: 800-854-4146
 E Mail: topnotch@ptd.net
 Web: www.4topnotch.com

**Tweeds Security
 Hardware Wholesale**

VA
 800-544-4482, 757-399-2180
 Fax: 757-399-1636
 E Mail: tweedslock@aol.com

U.S. Lock Corp.

NY
 800-925-5000, 631-243-3000
 Fax: 631-243-0390
 Web: www.uslock.org

Ultra Security

CA
 800-698-7477, 858-485-0698
 Fax: 858-485-0476

Wacker Hardware

IL
 800-956-3343, 312-733-6070
 Fax: 312-733-7001
 E Mail:
 wackerhardwareco@aol.com

Wadsworth White Inc.

GA
 800-717-8184, 770-717-8505
 Fax: 800-717-8227

**Wholesale 4
 Inc.**

OR
 800-547-0921, 503-238-8605
 Fax: 503-8139290

**Wholesale
 Cylinder Supply**

IN
 877-864-8809, 219-864-8879
 Fax: 219-864-8879
 E Mail: roy-miller@ameritech.net
 Web: www.wcslock.com

Wilco Supply

CA
 800-745-5450, 510-652-8522
 Fax: 510-653-5397
 E Mail:
 sales@wilcosupply.com
 Web: www.wilcosupply.com

**Worldwide
 Lock Supply
 Inc.**

CA
 800-729-5444, 818-781-9999
 Fax: 818-781-8171

Zipf Lock Co.

OH
 800-848-1577, 614-228-3507
 Fax: 800-228-6320
 E Mail: zipflockco@aol.com
 Web: www.ZIPFLOCKCO.com

**TRAINING
 MANUALS &
 MATERIALS**

**Access Safe &
 Supply Ltd.**

Canada
 800-268-9033, 905-795-9802
 Fax: 905-795-9804

**Agences W. Pelletier
 (1980) Inc.**

Canada
 800-363-6700, 514-276-6700
 Fax: 514-276-9413
 E Mail: sales@apa-pelletier.com
 Web: www.apa-pelletier.com

**Allied Locksmith
 Supply**

OH
 800-544-2102, 330-726-0866
 Fax: 330-726-0865
 E Mail: wiesnercorp@msn.com

Anderson Lock Co.

IL
 800-323-5625, 847-296-1157
 Fax: 847-296-9259
 E Mail: mail@andersonlock.com
 Web: www.andersonlock.com

**Blaydes
 Industries Inc.**

DC
 800-424-2650, 202-832-7100
 Fax: 202-832-1359
 E Mail: blaydesind@msn.com

**Clark
 Security
 Products**

CA
 800-854-2088, 619-505-1950
 Fax: 619-974-5290
 E Mail:
 webmaster@clarksecurity.com
 Web: www.clarksecurity.com

**Craftmaster
 Hardware Co. Inc.**

NJ
 800-221-3212, 201-646-9355
 Fax: 201-646-0181
 E Mail: info@craftmaster.net
 Web: www.craftmaster.net

**Cypress Security
 Products Ltd.**

CANADA
 800-561-1967, 403-250-1967
 Fax: 403-250-1969

**DiMark
 International Inc.**

CA
 800-235-2435, 805-922-1182
 Fax: 805-928-8034
 Web: www.pronet.net/dimark

DISTRIBUTORS by PRODUCT

AutoEdge



This CD contains over
 750 pages of automotive
 locksmith service.

CLICK HERE TO LEARN MORE

#AE - CD



**TRAINING
 MANUALS &
 MATERIALS
 (CONTINUED)**

**Direct
 Security
 Supply Inc.**

MA
 800-252-5757, 617-787-5200
 Fax: 800-452-8600

**Doyle Security
 Products**

MN
 800-333-6953, 612-521-6226
 Fax: 612-521-0166
 Web: www.doylesecurity.com

**E.L. Reinhardt
 Company**

MN
 800-328-1311, 651-481-0566
 Fax: 651-481-0166
 E Mail: elreinhard@uswest.net
 Web: www.plsgroup.com

**Ewert Wholesale
 Hardware Inc.**

IL
 800-451-0200, 708-597-0059
 Fax: 708-597-0881

Fairway Supply Inc.

TX
 800-776-3247
 Fax: 214-352-4299
 E Mail: fairwayinc@aol.com

**Foley Belsaw Co.
 Locksmith Division**

MO
 800-821-3452, 816-483-2700
 Fax: 816-483-5010

Fradon Lock Co. Inc.

NY
 800-447-0591, 315-472-6988
 Fax: 315-472-0958
 E Mail: fradonlock@aol.com

Fried Bros. Inc.

PA
 800-523-2924, 215-627-3205
 Fax: 215-592-1255
 E Mail:
 fbisecurity@fbisecurity.com
 Web: www.fbisecurity.com

**Garden State
 Hardware
 Wholesalers**

NJ
 800-544-0616, 908-753-1343
 Fax: 908-753-2040

Gil-Ray Tools Inc.

MI
 517-892-6870
 Fax: 517-892-6870
 E Mail:
 DJDEUEL@BIGFOOT.COM
 Web: www.angelfire.com/biz/
 gilraytoolsinc/

H.E. Mitchell Co.

OR
 800-626-5625, 503-236-9444
 Fax: 503-238-5715

**Hardware
 Agencies Ltd.**

Canada
 800-268-6741, 416-462-1919
 Fax: 416-462-1922
 E Mail:
 sales@hardwareagencies.com

**Herbert
 Flake Co.**

TX
 800-231-4105, 713-926-3200
 Fax: 713-926-3399
 E Mail: DanF@hlflake.com
 Web: www.hlflake.com

**Intermountain Lock
 & Supply**

CO
 800-323-8046, 303-698-1898
 Fax: 303-698-2094

**J. Nathan
 Hardware
 Specialties Inc.**

NJ
 800-634-2580, 716-325-3330
 Fax: 716-325-7196
 E Mail: @jnathan.com
 Web: www.jnathan.com

Jack Stearman Ltd.

Canada
 604-872-8415
 Fax: 604-875-9174

**Jo-Van
 Distributors
 Inc.**

CANADA
 888-752-7210, 416-752-7210
 Fax: 888-752-3845
 E Mail: sales@jovanlock.com
 Web: www.jovanlock.com

KDL Hardware Supply

WA
 800-524-9305, 206-682-7383
 Fax: 800-524-9305
 E Mail: REX@ESKIMO.COM
 Web: www.KDLLINK.COM

**Key Sales & Supply
 Co.**

MI
 800-445-KEYS (5397)
 313-931-7720
 Fax: 313-931-7758

**Keys Wholesale
 Distributors Inc.**

PA
 800-292-5397, 610-626-4787
 Fax: 610-626-4189

**Kramer Boys
 Locksmith Supply**

NJ
 800-222-2692, 609-586-0642
 Fax: 609-586-0512

LDM Enterprises Inc.

CA
 800-451-5950
 Fax: 818-706-8560
 E Mail:
 LDMINFO@LDMENT.COM
 Web: www.LDMENT.COM

**Lockmasters
 Inc.**

KY
 800-654-0637, 606-885-6041
 Fax: 606-885-7093
 E Mail: sales
 info@lockmasters.com
 Web: www.lockmaster.com

Locks Co.

FL
 800-288-0801, 305-949-0700
 Fax: 305-949-3619
 E Mail: locksco@gate.net
 Web: www.LOCKSCO.COM

LV Sales Inc.

CA
 800-894-keys, 323-661-4746
 Fax: 323-661-1314
 E Mail: sales@lvsales.com
 Web: www.lvsales.com

Major Lock Supply

CA
 714-447-8363
 Fax: 714-447-8393

**Maryland Security
 Distributors**

MD
 800-390-8889, 410-760-5625

**Mayflower
 Sales Co. Inc.**

NY
 800-221-2052, 718-622-8785
 Fax: 718-789-8346
 E Mail: pilgrim@mfsales.com
 Web: www.mfsales.com

**Maziuk Wholesale
 Distributors**

NY
 800-777-5945, 315-474-3959
 Fax: 315-472-3111
 E Mail: sales@mzkworld
 Web: www.mzkworld.com

MBA USA, Inc.

KY
 888-622-5495, 606-887-0496
 Fax: 606-887-9491
 E Mail: mbatools@aol.com
 Web: www.mbausa.com

**McDonald Dash
 Locksmith Supply Inc.**

TN
 800-238-7541, 901-797-8000
 Fax: 901-366-0005
 E Mail: JIMDT@AOL.COM

**McManus
 Locksmith
 Supply Inc.**

NC
 NC 800-432-6342 SC 800-
 438-6567, 704-333-9112
 or 704-333-0556
 Fax: 704-332-8664
 E Mail: mclock@bellsouth.net

**Mid-South
 Locksmith Supply**

TN
 800-238-6166, 901-795-6987
 Fax: 901-795-3475 or
 888-795-3475
 E Mail: midsouthlk@aol.com

DISTRIBUTORS by PRODUCT

**Flat Rate
 Manual**

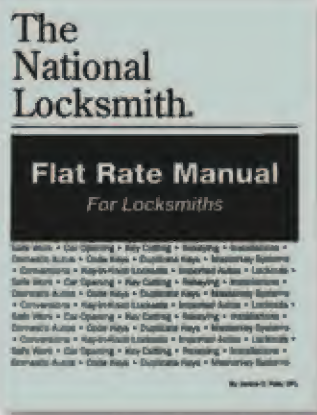

Now you can
 easily "Price
 for Profit!"

CLICK HERE TO LEARN MORE

#FRM - 1

National Locksmith Automobile Assn.

IL
630-837-2044
Fax: 630-837-1210
E Mail: natllock@aol.com
Web:
www.TheNationalLocksmith.com

National Locksmith, The

IL
630-837-2044
Fax: 630-837-1210
E Mail: natllock@aol.com
Web:
www.TheNationalLocksmith.com

National Safeman's Organization

IL
630-837-2044
Fax: 630-837-1210
E Mail: natllock@aol.com
Web:
www.TheNationalLocksmith.com

Northwest Lock & Supply Co.

OR
800-359-9425, 541-967-2749
Fax: 541-928-9338

Omaha Wholesale Hardware

NE
800-238-4566, 402-444-1673
Fax: 800-538-4566

Orchard Lock Distributors Inc.

CT
800-233-2146, 203-865-8106
Fax: 203-624-4083

R & H Wholesale Supply Inc.

CA
415-863-0404
Fax: 415-863-7046

RHS Security Hardware

OH
880-848-3348, 330-753-3257
Fax: 303-848-3338

Rininger Lock & Supply

CA
619-463-0170
Fax: 619-697-2590
E Mail:
RININGER@ELECTRICITI.COM
Web: www.ELECTRICITI.COM/
RININGER

Robert Skeels & Company

CA
800-734-4539, 310-639-7240
Fax: 310-639-7569

Web: www.SKEELS.COM

Safemasters Company Inc.

VA
800-633-9977, 703-256-6402
Fax: 703-750-1814
Web: www.safemasters.com

Security Plus Inc.

AZ
800-426-0200, 602-234-3883
Fax: 602-234-3882

Security Resources Inc.

FL
888-801-2003, 850-476-2799
Fax: 850-476-7410
Web:
www.techtrainproductions.com

Septon Inc.

NY
800-537-8752, 914-246-0638
Fax: 914-246-3416

Serrubec Inc.

Canada
800-361-0243, 514-631-6791
Fax: 514-631-0494
E Mail:
SERRUBEC@SYMPATICO.CA

Shield Supply & Services Ltd.

CANADA
204-774-1921
Fax: 204-774-5627

Slide Lock Tool Co. Inc. Attn: Z-Tool Division

TN
800-336-8812, 865-577-8470
Fax: 865-577-5936

Southern Lock & Supply Co.

FL
800-282-2837, 727-541-5536
Fax: 800-447-2299
E Mail:
sales@southernlock.com
Web: www.southernlock.com

Space Age Locksmith Supplies Inc.

FL
800-247-7942, 904-734-3113
Fax: 904-734-0559

Stone & Berg Wholesale Locksmith Supply

MA
800-225-7405, 508-753-3551
Fax: 800-535-5625
Web: www.stoneandberg.com

Timemaster Inc.

KS
888-798-8464
Fax: 800-798-TIME (8463)
E Mail: TIMSTR@AOL.COM
Web: www.time-master.com

Diary Of A Safeman

Diary Of A Safeman

The journal of safeman C.L. Corey with details of safe cracking in the 1930's. Relive the diary of Al Capone.



With an Introduction by
Dave Mc Ornie

This book is a real gem...the private safe diary of old time safecracker C.L. Corey.

CLICK HERE TO LEARN MORE



#DIARY

DISTRIBUTORS by PRODUCT

**TRAINING
 MANUALS &
 MATERIALS
 (CONTINUED)**

**Tweeds Security
 Hardware Wholesale**
 VA
 800-544-4482, 757-399-2180
 Fax: 757-399-1636
 E Mail: tweedslock@aol.com

U.S. Lock Corp.
 NY
 800-925-5000, 631-243-3000
 Fax: 631-243-0390
 Web: www.uslock.org

**Wholesale 4
 Inc.**

OR
 800-547-0921, 503-238-8605
 Fax: 503-8139290

Wilco Supply
 CA
 800-745-5450, 510-652-8522
 Fax: 510-653-5397
 E Mail: sales@wilcosupply.com
 Web: www.wilcosupply.com

**Worldwide
 Lock Supply
 Inc.**

CA
 800-729-5444, 818-781-9999
 Fax: 818-781-8171

Zipf Lock Co.

OH
 800-848-1577, 614-228-3507
 Fax: 800-228-6320
 E Mail: zipflockco@aol.com
 Web: www.zipflockco.com

**LOCKSMITH
 SOFTWARE**

**Access Safe &
 Supply Ltd.**

Canada
 800-268-9033, 905-795-9802
 Fax: 905-795-9804

**Accredited Lock
 Supply Co.**

NJ
 800-652-2835, 201-865-5015
 Fax: 201-865-5031
 E Mail: mail@acclock.com
 Web: www.acclock.com

**Ace Lock
 & Security
 Supply**

NJ
 800-223-5625, 908-688-7666
 Fax: 908-688-2442
 E Mail: acelock@acelock.com
 Web: www.acelock.com

**Agences W. Pelletier
 (1980) Inc.**
 Canada

800-363-6700, 514-276-6700
 Fax: 514-276-9413
 E Mail: sales@apa-pelletier.com
 Web: www.apa-pelletier.com

**Allied Locksmith
 Supply**

OH
 800-544-2102, 330-726-0866
 Fax: 330-726-0865
 E Mail: wiesnercorp@msn.com

**Associated Lock
 & Supply**

Canada
 800-668-7161, 604-942-5625
 Fax: 604-942-3761

**AutoSmart
 Advisor**

IL
 630-837-2044
 Fax: 630-837-1210
 E Mail: natllock@aol.com
 Web:
 www.AutoSmartAdvisor.com

**Blaydes
 Industries Inc.**

DC
 800-424-2650, 202-832-7100
 Fax: 202-832-1359
 E Mail: blaydesind@msn.com

Boyle & Chase Inc.

MA
 800-325-2530, 781-337-3904
 Fax: 800-205-3500
 E Mail:
 sales@boyleandchase.com
 Web: www.boyleandchase.com

City Lock & Safe

CO
 303-444-4407
 Fax: 303-442-8380
 E Mail: Dougsco@aol.com

**Clark
 Security
 Products**

CA
 800-854-2088, 619-505-1950
 Fax: 619-974-5290
 E Mail:
 webmaster@clarksecurity.com
 Web: www.clarksecurity.com

**Commonwealth
 Lock Co.**

MA
 800-442-7009, 617-876-3301
 Fax: 617-661-3168
 E Mail: clc1936@aol.com
 Web: www.commonwealth
 lockco.bizonthe.net

**Craftmaster
 Hardware Co. Inc.**

NJ
 800-221-3212, 201-646-9355
 Fax: 201-646-0181
 E Mail: info@craftmaster.net
 Web: www.craftmaster.net

**Cypress Security
 Products Ltd.**

CANADA
 800-561-1967, 403-250-1967
 Fax: 403-250-1969

**DiMark
 International Inc.**

CA
 800-235-2435, 805-922-1182
 Fax: 805-928-8034
 Web: www.pronet.net/dimark

**Direct
 Security
 Supply Inc.**

MA
 800-252-5757, 617-787-5200
 Fax: 800-452-8600

**Doyle Security
 Products**

MN
 800-333-6953, 612-521-6226
 Fax: 612-521-0166
 Web: www.doylesecurity.com

**E.L. Reinhardt
 Company**

MN
 800-328-1311, 651-481-0566
 Fax: 651-481-0166
 E Mail: elreinhard+@uswest.net
 Web: www.plsgroup.com

**Ewert Wholesale
 Hardware Inc.**

IL
 800-451-0200, 708-597-0059
 Fax: 708-597-0881

Fairway Supply Inc.

TX
 800-776-3247
 Fax: 214-352-4299
 E Mail: fairwayinc@aol.com

**Foley Belsaw Co.
 Locksmith Division**

MO
 800-821-3452, 816-483-2700
 Fax: 816-483-5010

Fried Bros. Inc.

PA
 800-523-2924, 215-627-3205
 Fax: 215-592-1255
 E Mail:
 fbisecurity@fbisecurity.com
 Web: www.fbisecurity.com

**Garden State
 Hardware
 Wholesalers**

NJ
 800-544-0616, 908-753-1343
 Fax: 908-753-2040

H.E. Mitchell Co.

OR
 800-626-5625, 503-236-9444
 Fax: 503-238-5715

**H.S. & S. Wholesale
 Dist. of Lock Hdwe.**

MI
 800-521-2202, 313-342-6777
 Fax: 313-342-7580

**Hans Johnsen
 Co.**

TX
 888-879-1500, 214-879-1550
 Fax: 214-879-1530
 E Mail: LOCKHJC@AOL.COM
 Web: www.hjc.com

DISTRIBUTORS by PRODUCT

AutoSmart

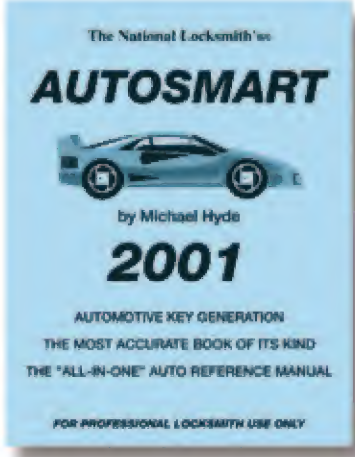

**A MUST
 for every
 locksmith!**

CLICK HERE TO LEARN MORE



Hardware Agencies Ltd.

Canada
800-268-6741, 416-462-1919
Fax: 416-462-1922
E Mail:
sales@hardwareagencies.com

Herbert Flake Co.

TX
800-231-4105, 713-926-3200
Fax: 713-926-3399
E Mail: DanF@hflflake.com
Web: www.hflflake.com

InstaCode 200 I

IL
630-837-2044
Fax: 630-837-1210
E Mail: natllock@aol.com
Web:
www.TheNationalLocksmith.com

Intermountain Lock & Supply

CO
800-323-8046, 303-698-1898
Fax: 303-698-2094

J. Nathan Hardware Specialties Inc.

NY
800-634-2580, 716-325-3330
Fax: 716-325-7196
E Mail: @jnathan.com
Web: www.jnathan.com

Jack Stearman Ltd. Canada

604-872-8415
Fax: 604-875-9174

Jo-Van Distributors Inc.

CANADA
888-752-7210, 416-752-7210
Fax: 888-752-3845
E Mail: sales@jovanlock.com
Web: www.jovanlock.com

KDL Hardware Supply

WA
800-524-9305, 206-682-7383
Fax: 800-524-9305
E Mail: REX@ESKIMO.COM
Web: www.KDLLINK.COM

Key Sales & Supply Co.

MI
800-445-KEYS (5397)
313-931-7720
Fax: 313-931-7758

LDM Enterprises Inc.

CA
800-451-5950
Fax: 818-706-8560
E Mail:
LDMINFO@LDMENT.COM
Web: www.LDMENT.COM

Locks Co.

FL
800-288-0801, 305-949-0700

Fax: 305-949-3619
E Mail:
LOCKSCO@GATE.NET
Web: www.LOCKSCO.COM

Locksmith Dispatcher 2000

IL
630-837-2044
Fax:
630-837-1210
E Mail: natllock@aol.com
Web: www.DiamondSoftware Systems.com

Locksmith Store Inc., The

IL
847-364-5111
Fax: 847-364-5125
Web: www.locksmithstore.com

LV Sales Inc.

CA
800-894-keys, 323-661-4746
Fax: 323-661-1314
E Mail: sales@lvsales.com
Web: www.lvsales.com

M. Shepse Co. Div. American Bionics

PA
800-666-6007, 412-381-4900
Fax: 412-381-5122

Major Lock Supply

CA
714-447-8363
Fax: 714-447-8393

Maryland Security Distributors

MD
800-390-8889, 410-760-5625

Mayflower Sales Co. Inc.

NY
800-221-2052, 718-622-8785
Fax: 718-789-8346
E Mail: pilgrim@mfsales.com
Web: www.mfsales.com

Maziuk Wholesale Distributors

NY
800-777-5945, 315-474-3959
Fax: 315-472-3111
E Mail: sales@mzkworld
Web: www.mzkworld.com

McDonald Dash Locksmith Supply Inc.

TN
800-238-7541, 901-797-8000
Fax: 901-366-0005
E Mail: JIMDT@AOL.COM

McManus Locksmith Supply Inc.

NC

NC 800-432-6342 SC 800-438-6567, 704-333-9112 or 704-333-0556
Fax: 704-332-8664
E Mail: mclock@bellsouth.net

Mid-South Locksmith Supply

TN
800-238-6166, 901-795-6987
Fax: 901-795-3475 or 888-795-3475
E Mail: midsouthlk@aol.com

National Locksmith Automobile Assn.

IL
630-837-2044
Fax: 630-837-1210
E Mail: natllock@aol.com
Web:
www.TheNationalLocksmith.com

National Locksmith, The

IL
630-837-2044
Fax: 630-837-1210
E Mail: natllock@aol.com
Web:
www.TheNationalLocksmith.com

National Safeman's Organization

IL
630-837-2044
Fax: 630-837-1210
E Mail: natllock@aol.com
Web:
www.TheNationalLocksmith.com

Northwest Lock & Supply Co.

OR
800-359-9425, 541-967-2749
Fax: 541-928-9338

O'Brien Bros. Inc.

MA
800-343-0949, 413-734-7121
Fax: 413-737-1642

Omaha Wholesale Hardware

NE
800-238-4566, 402-444-1673
Fax: 800-538-4566

Pasek Corp.

MA
800-628-2822, 617-269-7110
Fax: 617-269-0547 or 800-262-0547
E Mail: PASEK@PASEK.COM

R & H Wholesale Supply Inc.

CA
415-863-0404
Fax: 415-863-7046

TNL on CD



CLICK HERE TO LEARN MORE

#TNL - CD1

DISTRIBUTORS by PRODUCT

**LOCKSMITH
SOFTWARE
(CONTINUED)**

**RHS Security
Hardware**

OH
880-848-3348, 330-753-3257
Fax: 303-848-3338

**Rininger Lock
& Supply**

CA
619-463-0170
Fax: 619-697-2590
E Mail:
RININGER@ELECTRICITI.COM
Web: www.ELECTRICITI.COM/
RININGER

**Robert Skeels
& Company**

CA
800-734-4539, 310-639-7240
Fax: 310-639-7569
Web: www.SKEELS.COM

**Safemasters
Company Inc.**

VA
800-633-9977, 703-256-6402
Fax: 703-750-1814
Web: www.safemasters.com

Security Plus Inc.

AZ
800-426-0200, 602-234-3883
Fax: 602-234-3882

Security Resources Inc.

FL
888-801-2003, 850-476-2799
Fax: 850-476-7410
Web:
www.techtrainproductions.com

Serrubec Inc.

Canada
800-361-0243, 514-631-6791
Fax: 514-631-0494
E Mail:
SERRUBEC@SYMPATICO.CA

**Shield Supply &
Services Ltd.**

CANADA
204-774-1921
Fax: 204-774-5627

**Southern Lock
& Supply Co.**

FL
800-282-2837, 727-541-5536
Fax: 800-447-2299
E Mail: sales@southernlock.com
Web: www.southernlock.com

**Stone & Berg Wholesale
Locksmith Supply**

MA
800-225-7405, 508-753-3551
Fax: 800-535-5625
Web: www.stoneandberg.com

**Taylor Security
& Lock Co. Inc.**

MD
800-676-7670, 301-948-7670
Fax: 301-948-1029
E Mail: sales@locks.net
Web: www.locks.net

**Tweeds Security
Hardware Wholesale**

VA
800-544-4482, 757-399-2180
Fax: 757-399-1636
E Mail: tweedslock@aol.com

U.S. Lock Corp.

NY
800-925-5000, 631-243-3000
Fax: 631-243-0390
Web: www.uslock.org

Wacker Hardware

IL
800-956-3343, 312-733-6070
Fax: 312-733-7001
E Mail:
wackerhardwareco@aol.com

**Wholesale 4
Inc.**

OR
800-547-0921, 503-238-8605
Fax: 503-8139290

Wilco Supply

CA
800-745-5450, 510-652-8522
Fax: 510-653-5397
E Mail: sales@wilcosupply.com
Web: www.wilcosupply.com

**Worldwide
Lock Supply
Inc.**

CA
800-729-5444, 818-781-9999
Fax: 818-781-8171

Zipf Lock Co.

OH
800-848-1577, 614-228-3507
Fax: 800-228-6320
E Mail: zipflockco@aol.com
Web: www.zipflockco.com

**ELECTRONIC
SECURITY
PRODUCTS**

**Access
Hardware
Supply**

CA
800-348-2263, 510-483-5000
Fax: 800-435-8233
E Mail: JREAM@LOCKS.com
Web:
www.accesshardware.com

**Accredited Lock
Supply Co.**

NJ
800-652-2835, 201-865-5015
Fax: 201-865-5031
E Mail: mail@accllock.com
Web: www.accllock.com

**Ace Lock The
Security People**

PA
800-824-7712, 412-363-3328
Fax: 412-363-7540
E Mail: info@acelockinc.com

**Ace Lock
& Security
Supply**

NJ
800-223-5625, 908-688-7666
Fax: 908-688-2442
E Mail: acelock@acelock.com
Web: www.acelock.com

**Agences W. Pelletier
(1980) Inc.**

Canada
800-363-6700, 514-276-6700
Fax: 514-276-9413
E Mail: sales@apa-pelletier.com
Web: www.apa-pelletier.com

**Akron
Hardware
Consultants**

OH
800-321-9602, 330-644-7167
Fax: 800-328-6070
Web: www.akronhardware.com

**American Lock
& Key Co.**

VA
800-995-6247, 804-282-6060
Fax: 804-282-1007

Anderson Lock Co.

IL
800-323-5625, 847-296-1157
Fax: 847-296-9259
E Mail: mail@andersonlock.com
Web: www.andersonlock.com

**Associated Lock
& Supply**

Canada
800-668-7161, 604-942-5625
Fax: 604-942-3761

**Automatic Gate
Wholesalers**

CA
800-238-2301, 650-365-4340
Fax: 800-438-2301

Bell's Security Sales Inc.

NJ
800-772-2266, 973-743-3709
Fax: 973-743-6357

Berg Wholesale Inc.

OR
800-243-8887, 503-220-0000
Fax: 503-228-9410

**Blaydes
Industries Inc.**

DC
800-424-2650, 202-832-7100
Fax: 202-832-1359
E Mail: blaydesind@msn.com

Boyle & Chase Inc.

MA
800-325-2530, 781-337-3904
Fax: 800-205-3500
E Mail: sales@boyleandchase.com
Web: www.boyleandchase.com

**Brook's Lock
& Supply Inc.**

AL
800-292-5008, 205-353-2596
Fax: 205-353-8260

E Mail:
brooksloc@brookslock.com
Web: www.brookslock.com

Brooks Wholesale

AL
800-292-5008
Fax: 205-353-8260
E Mail: brooksloc@tiger.net-
master.net
Web: www.brookslock.com

City Lock & Safe

CO
303-444-4407
Fax: 303-442-8380
E Mail: Dougsco@aol.com

**Clark
Security
Products**

CA
800-854-2088, 619-505-1950
Fax: 619-974-5290
E Mail:
webmaster@clarksecurity.com
Web: www.clarksecurity.com

**Colonial Lock
Supply Co. Inc**

VA
800-732-9117, 703-550-8558
Fax: 703-550-8857

**Commonwealth
Lock Co.**

MA
800-442-7009, 617-876-3301
Fax: 617-661-3168
E Mail: clc1936@aol.com
Web: www.commonwealth
lockco.bizonthenet

**Craftmaster
Hardware Co. Inc**

NJ
800-221-3212, 201-646-9355
Fax: 201-646-0181
E Mail: info@craftmaster.net
Web: www.craftmaster.net

**Cypress Security
Products Ltd.**

CANADA
800-561-1967, 403-250-1967
Fax: 403-250-1969

**Direct
Security
Supply Inc.**

MA
800-252-5757, 617-787-5200
Fax: 800-452-8600

Doyle Security Products

MN
800-333-6953, 612-521-6226
Fax: 612-521-0166
Web: www.doylesecurity.com

Dugmore and Duncan

MA
888-384-6673
Fax: 888-329-3846
E Mail: sales@dugmore.com
Web: www.dugmore.com

**LOCKSMITH
SOFTWARE
(CONTINUED)**

**E.L. Reinhardt
Company**

MN
800-328-1311, 651-481-0566
Fax: 651-481-0166
E Mail: elreinhard+@uswest.net
Web: www.plsgroup.com

**Empire Security
Supplies**

NY
516-928-1919
Fax: 516-928-4745

Encon Electronics

CA
800-782-5598, 510-782-5598
Fax: 510-782-4290
E Mail: encon@california.com
Web:
www.enconelectronics.com

**Ewert Wholesale
Hardware Inc.**

IL
800-451-0200, 708-597-0059
Fax: 708-597-0881

Express Hardware

IL
800-323-7447, 847-381-9430
Fax: 847-381-7199

Fairway Supply Inc.

TX
800-776-3247
Fax: 214-352-4299
E Mail: fairwayinc@aol.com

Fastrack Hardware Inc.

WI
800-458-8707, 262-781-8118
Fax: 800-667-8701 or
262-781-1162

Fortress Safe & Lock

OH
800-562-0295, 513-772-4392
Fax: 513-326-5983

Fradon Lock Co. Inc.

NY
800-447-0591, 315-472-6988
Fax: 315-472-0958
E Mail: fradonlock@aol.com

Fried Bros. Inc.

PA
800-523-2924, 215-627-3205
Fax: 215-592-1255
E Mail:
fbisecurity@fbisecurity.com
Web: www.fbisecurity.com

**Garden State
Hardware Wholesalers**

NJ
800-544-0616, 908-753-1343
Fax: 908-753-2040

**H & H Lock &
Security Wholesalers**

MD
800-772-9811, 301-948-1996
Fax: 301-948-5265
E Mail: hhlock@erols.com
Web: www.hhlock.com

H.E. Mitchell Co.

OR
800-626-5625, 503-236-9444
Fax: 503-238-5715

**H.S. & S. Wholesale
Dist. of Lock Hdwe.**

MI
800-521-2202, 313-342-6777
Fax: 313-342-7580

Hahn & Schaffner Inc.

NY
888-645-8696, 716-928-2850
Fax: 716-928-2852

**Hans Johnsen
Co.**

TX
888-879-1500, 214-879-1550
Fax: 214-879-1530
E Mail: LOCKHJC@AOL.COM
Web: www.hjc.com

Hardinge Bros. Limited

Canada
905-470-8844
Fax: 905-470-2767
E Mail: hardinge@accessv.com
Web: www.cansecure.com

Hardware Agencies Ltd.

Canada
800-268-6741, 416-462-1919
Fax: 416-462-1922
E Mail:
sales@hardwareagencies.com

**Herbert
Flake Co.**

TX
800-231-4105, 713-926-3200
Fax: 713-926-3399
E Mail: DanF@hlflake.com
Web: www.hlflake.com

Howard Sales Co.

TX
800-456-4625, 915-833-7733
Fax: 915-833-7770
E Mail: howard@whc.net
Web: www.howardsales.com

**Independent
Hardware Inc.**

PA
800-346-9464, 215-925-5306
Fax: 215-922-6552
E Mail: roommate4@aol.com

**Intek Global Corp.
(Midland Land Mobil
Radio)**

MO
800-669-4567, 816-241-8400
Fax: 816-920-1144

**Intermountain
Lock & Supply**

CO
800-323-8046, 303-698-1898
Fax: 303-698-2094

**Island Pacific
Distributors Inc.**

HI
808-955-1126
Fax: 808-946-6480

J. Nathan

**Hardware
Specialties Inc.**

NY
800-634-2580, 716-325-3330
Fax: 716-325-7196
E Mail: @jnathan.com
Web: www.jnathan.com

Jack Stearman Ltd.

Canada
604-872-8415
Fax: 604-875-9174

**JLM
Wholesale Inc.**

MI
800-522-2940, 248-628-6440
Fax: 800-782-1160
E Mail: sales@jlmwholesale.com
Web: www.jlmwholesale.com

**Jo-Van
Distributors
Inc.**

CANADA
888-752-7210, 416-752-7210
Fax: 888-752-3845
E Mail: sales@jovanlock.com
Web: www.jovanlock.com

KDL Hardware Supply

WA
800-524-9305, 206-682-7383
Fax: 800-524-9305
E Mail: REX@ESKIMO.COM
Web: www.KDLLINK.COM

Key Sales & Supply Co.

MI
800-445-KEYS (5397)
313-931-7720
Fax: 313-931-7758

**Kramer Boys
Locksmith Supply**

NJ
800-222-2692, 609-586-0642
Fax: 609-586-0512

**Lockmasters
Inc.**

KY
800-654-0637
606-885-6041
Fax: 606-885-7093
E Mail: sales
info@lockmasters.com
Web: www.lockmaster.com

Locks Co.

FL
800-288-0801, 305-949-0700
Fax: 305-949-3619
E Mail: LOCKSCO@GATE.NET
Web: www.LOCKSCO.COM

LV Sales Inc.

CA
800-894-keys, 323-661-4746
Fax: 323-661-1314
E Mail: sales@lvsales.com
Web: www.lvsales.com

**M. Shepse Co. Div.
American Bionics**

PA
800-666-6007, 412-381-4900
Fax: 412-381-5122

Major Lock Supply

CA
714-447-8363
Fax: 714-447-8393

Martco

KY
800-233-7769, 502-635-1600
Fax: 502-637-6430
Web: www.martcoinc.com

**Maryland Security
Distributors**

MD
800-390-8889, 410-760-5625

**Mayflower
Sales Co. Inc.**

NY
800-221-2052, 718-622-8785
Fax: 718-789-8346
E Mail: pilgrim@mfsales.com
Web: www.mfsales.com

**Maziuk Wholesale
Distributors**

NY
800-777-5945, 315-474-3959
Fax: 315-472-3111
E Mail: sales@mzkworld
Web: www.mzkworld.com

**McDonald Dash
Locksmith Supply Inc.**

TN
800-238-7541, 901-797-8000
Fax: 901-366-0005
E Mail: JIMDT@AOL.COM

**MD Wholesale
Hardware**

IL
800-345-7116, 847-541-0010
Fax: 847-541-0020
E Mail: info@mdhardware.com
Web: www.mdhardware.com

**Mid-South
Locksmith Supply**

TN
800-238-6166, 901-795-6987
Fax: 901-795-3475 or
888-795-3475
E Mail: midsouthlk@aol.com

**Midwest Wholesale
Hardware**

MO
800-821-8527, 816-241-5663
Fax: 800-621-6581
E Mail: HDWSales@
midwestwholesale.com

**Monaco Lock
Company Inc.**

NJ
800-526-6094, 201-659-7969
Fax: 201-659-7970
E Mail: monacolock@aol.com
Web: www.monacolock.com

**Northwest Lock
& Supply Co.**

OR
800-359-9425, 541-967-2749
Fax: 541-928-9338

O'Brien Bros. Inc.

MA
800-343-0949, 413-734-7121
Fax: 413-737-1642

Omaha Wholesale Hardware

NE
 800-238-4566, 402-444-1673
 Fax: 800-538-4566

Pasek Corp.

MA
 800-628-2822, 617-269-7110
 Fax: 617-269-0547 or 800-262-0547
 E Mail: PASEK@PASEK.COM

R & H Wholesale Supply Inc.

CA
 415-863-0404
 Fax: 415-863-7046

RHS Security Hardware

OH
 880-848-3348, 330-753-3257
 Fax: 303-848-3338

Richardson Electronics Ltd.

IL
 800-348-5580, 630-208-2200
 Fax: 630-208-2550
 Web: www.rell.com

Rininger Lock & Supply

CA
 619-463-0170
 Fax: 619-697-2590
 E Mail:
 RININGER@ELECTRICITI.COM
 Web: www.ELECTRICITI.COM/
 RININGER

Robert Skeels & Company

CA
 800-734-4539, 310-639-7240
 Fax: 310-639-7569
 Web: www.SKEELS.COM

S & J Products & Services

WA
 800-735-1797, 509-575-1797
 Fax: 509-575-1875

S.D.I. (Security Distributors, Inc)

TX
 214-879-1563
 Fax: 214-879-1525

Safemasters Company Inc.

VA
 800-633-9977, 703-256-6402
 Fax: 703-750-1814
 Web: www.safemasters.com

Security Equipment Supply

MO
 800-325-0221, 314-298-8930
 Fax: 314-298-8962

Security House Padlock Distributors

CANADA
 888-PADLOCKS "Canada wide", 905-669-5300
 Fax: 905-660-6313

Security Lock Distributors

MA
 800-847-5625, 781-444-1155
 Fax: 800-878-6400
 E Mail: SECLOCK@IX
 NETCOM.COM

Security Plus Inc.

AZ
 800-426-0200, 602-234-3883
 Fax: 602-234-3882

Serrubec Inc.

Canada
 800-361-0243, 514-631-6791
 Fax: 514-631-0494
 E Mail:
 SERRUBEC@SYMPATICO.CA

Shield Supply & Services Ltd.

CANADA
 204-774-1921
 Fax: 204-774-5627

Silver Sales

FL
 800-258-5625, 941-561-9366
 Fax: 941-561-9368
 E Mail: mail@silversalesusa.com
 Web: www.silversalesusa.com

Southern Lock & Supply Co.

FL
 800-282-2837, 727-541-5536
 Fax: 800-447-2299
 E Mail: sales@southernlock.com
 Web: www.southernlock.com

Stone & Berg Wholesale Locksmith Supply

MA
 800-225-7405, 508-753-3551
 Fax: 800-535-5625
 Web: www.stoneandberg.com

Taylor Security & Lock Co. Inc.

MD
 800-676-7670, 301-948-7670
 Fax: 301-948-1029
 E Mail: sales@locks.net
 Web: www.locks.net

Timemaster Inc.

KS
 888-798-8464
 Fax: 800-798-TIME (8463)
 E Mail: TIMSTR@AOL.COM
 Web: www.TIME-MASTER.COM

Tweeds Security Hardware Wholesale

VA
 800-544-4482, 757-399-2180
 Fax: 757-399-1636
 E Mail: tweedslock@aol.com

U.S. Lock Corp.

NY
 800-925-5000, 631-243-3000
 Fax: 631-243-0390
 Web: www.uslock.org

Wacker Hardware

IL
 800-956-3343, 312-733-6070
 Fax: 312-733-7001
 E Mail:
 wackerhardwareco@aol.com

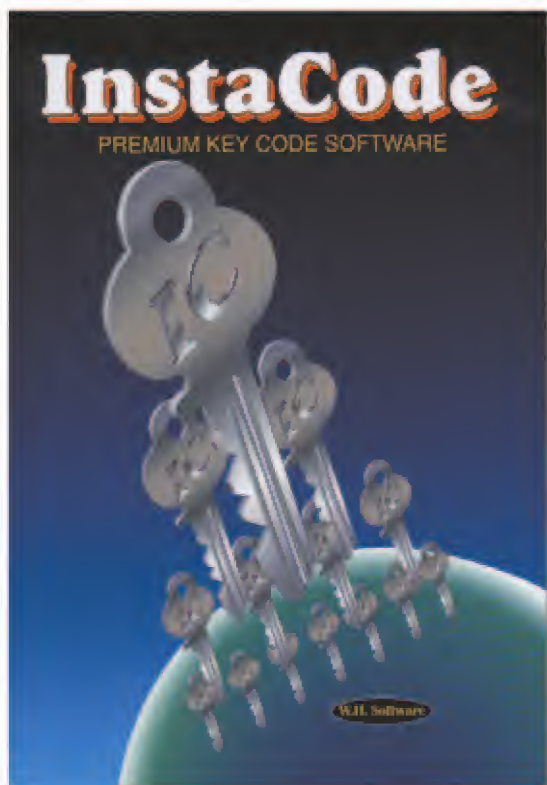

InstaCode

Your total code and code machine management program.



CLICK HERE TO LEARN MORE

#IC - 2001

DISTRIBUTORS by PRODUCT

**LOCKSMITH
SOFTWARE
(CONTINUED)**

Wadsworth White Inc.
GA
800-717-8184, 770-717-8505
Fax: 800-717-8227

Westguard Inc.
OH
888-699-9378, 330-963-6116
Fax: 330-425-1834
E Mail: westguard@westguard-inc.com
Web: www.westguard-inc.com

Wholesale 4 Inc.
OR
800-547-0921, 503-238-8605
Fax: 503-8139290

Wilco Supply
CA
800-745-5450, 510-652-8522
Fax: 510-653-5397
E Mail: sales@wilcosupply.com
Web: www.wilcosupply.com

Worldwide Lock Supply Inc.
CA
800-729-5444, 818-781-9999
Fax: 818-781-8171

Zipf Lock Co.
OH
800-848-1577, 614-228-3507
Fax: 800-228-6320
E Mail: zipflockco@aol.com
Web: www.zipflockco.com

**LOCKING
PRODUCTS**

Access Safe & Supply Ltd.
Canada
800-268-9033, 905-795-9802
Fax: 905-795-9804

Accredited Lock Supply Co.
NJ
800-652-2835, 201-865-5015
Fax: 201-865-5031
E Mail: mail@acclock.com
Web: www.acclock.com

Ace Lock & Security Supply
NJ
800-223-5625, 908-688-7666
Fax: 908-688-2442
E Mail: acelock@acelock.com
Web: www.acelock.com

Agences W. Pelletier (1980) Inc.
Canada
800-363-6700, 514-276-6700

Fax: 514-276-9413
E Mail: sales@apa-pelletier.com
Web: www.apa-pelletier.com

Allied Locksmith Supply
OH
800-544-2102, 330-726-0866
Fax: 330-726-0865
E Mail: wiesnercorp@msn.com

Associated Lock & Supply
Canada
800-668-7161, 604-942-5625
Fax: 604-942-3761

AutoSmart Advisor
IL
630-837-2044
Fax: 630-837-1210
E Mail: natllock@aol.com
Web: www.AutoSmartAdvisor.com

Blaydes Industries Inc.
DC
800-424-2650, 202-832-7100
Fax: 202-832-1359
E Mail: blaydesind@msn.com

Boyle & Chase Inc.
MA
800-325-2530, 781-337-3904
Fax: 800-205-3500
E Mail: sales@boyleandchase.com
Web: www.boyleandchase.com

City Lock & Safe
CO
303-444-4407
Fax: 303-442-8380
E Mail: Dougsco@aol.com

Clark Security Products
CA
800-854-2088, 619-505-1950
Fax: 619-974-5290
E Mail: webmaster@clarksecurity.com
Web: www.clarksecurity.com

Commonwealth Lock Co.
MA
800-442-7009, 617-876-3301
Fax: 617-661-3168
E Mail: clc1936@aol.com
Web: www.commonwealthlockco.bizonthe.net

Craftmaster Hardware Co. Inc.
NJ
800-221-3212, 201-646-9355
Fax: 201-646-0181
E Mail: info@craftmaster.net
Web: www.craftmaster.net

Cypress Security Products Ltd.
CANADA
800-561-1967, 403-250-1967
Fax: 403-250-1969

DiMark International Inc.
CA
800-235-2435, 805-922-1182
Fax: 805-928-8034
Web: www.pronet.net/dimark

Direct Security Supply Inc.
MA
800-252-5757, 617-787-5200
Fax: 800-452-8600

Doyle Security Products
MN
800-333-6953, 612-521-6226
Fax: 612-521-0166
Web: www.doylesecurity.com

E.L. Reinhardt Company
MN
800-328-1311, 651-481-0566
Fax: 651-481-0166
E Mail: elreinhard+@uswest.net
Web: www.plsgroup.com

Ewert Wholesale Hardware Inc.
IL
800-451-0200, 708-597-0059
Fax: 708-597-0881

Fairway Supply Inc.
TX
800-776-3247
Fax: 214-352-4299
E Mail: fairwayinc@aol.com

Foley Belsaw Co. Locksmith Division
MO
800-821-3452, 816-483-2700
Fax: 816-483-5010

Fried Bros. Inc.
PA
800-523-2924, 215-627-3205
Fax: 215-592-1255
E Mail: fbisecurity@fbisecurity.com
Web: www.fbisecurity.com

Garden State Hardware Wholesalers
NJ
800-544-0616, 908-753-1343
Fax: 908-753-2040

H.E. Mitchell Co.
OR
800-626-5625, 503-236-9444
Fax: 503-238-5715

H.S. & S. Wholesale Dist. of Lock Hdwe
MI
800-521-2202, 313-342-6777
Fax: 313-342-7580

Hans Johnsen Co.
TX
888-879-1500, 214-879-1550
Fax: 214-879-1530
E Mail: LOCKHJC@AOL.COM
Web: www.hjc.com

DISTRIBUTORS by PRODUCT

**Manipulation
Home Study
Course**

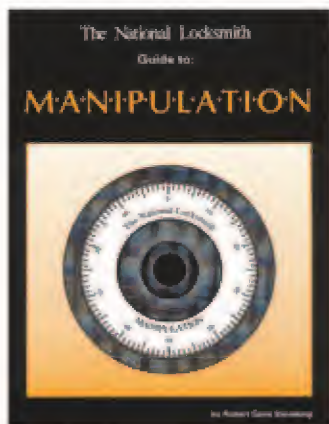

Our home study course guides you on step-by-step process, teaching you everything there is to know about manipulation.

CLICK HERE TO LEARN MORE

#MAN - 1



Hardware Agencies Ltd.

Canada
800-268-6741, 416-462-1919
Fax: 416-462-1922
E Mail:
sales@hardwareagencies.com

Herbert Flake Co.

TX
800-231-4105, 713-926-3200
Fax: 713-926-3399
E Mail: DanF@hflake.com
Web: www.hflake.com

InstaCode 200 I

IL
630-837-2044
Fax:
630-837-1210
E Mail: natllock@aol.com
Web:
www.TheNationalLocksmith.com

Intermountain Lock & Supply

CO
800-323-8046, 303-698-1898
Fax: 303-698-2094

J. Nathan Hardware Specialties Inc.

NY
800-634-2580, 716-325-3330
Fax: 716-325-7196
E Mail: @jnathan.com
Web: www.jnathan.com

Jack Stearman Ltd

Canada
604-872-8415
Fax: 604-875-9174

Jo-Van Distributors Inc.

CANADA
888-752-7210, 416-752-7210
Fax: 888-752-3845
E Mail: sales@jovanlock.com
Web: www.jovanlock.com

KDL Hardware Supply

WA
800-524-9305, 206-682-7383
Fax: 800-524-9305
E Mail: REX@ESKIMO.COM
Web: www.KDLLINK.COM

Key Sales & Supply Co.

MI
800-445-KEYS (5397)
313-931-7720
Fax: 313-931-7758

LDM Enterprises Inc.

CA
800-451-5950
Fax: 818-706-8560
E Mail:
LDMINFO@LDMENT.COM
Web: www.LDMENT.COM

Locks Co.

FL

800-288-0801, 305-949-0700
Fax: 305-949-3619
E Mail: LOCKSCO@GATE.NET
Web: www.LOCKSCO.COM

Locksmith Dispatcher 2000

IL
630-837-2044
Fax: 630-837-1210
E Mail: natllock@aol.com
Web: www.DiamondSoftware Systems.com

Locksmith Store Inc., The

IL
847-364-5111
Fax: 847-364-5125
Web: www.locksmithstore.com

LV Sales Inc.

CA
800-894-keys, 323-661-4746
Fax: 323-661-1314
E Mail: sales@lvsales.com
Web: www.lvsales.com

M. Shepse Co. Div. American Bionics

PA
800-666-6007, 412-381-4900
Fax: 412-381-5122

Major Lock Supply

CA
714-447-8363
Fax: 714-447-8393

Maryland Security Distributors

MD
800-390-8889, 410-760-5625

Mayflower Sales Co. Inc.

NY
800-221-2052, 718-622-8785
Fax: 718-789-8346
E Mail: pilgrim@mfsales.com
Web: www.mfsales.com

Maziuk Wholesale Distributors

NY
800-777-5945, 315-474-3959
Fax: 315-472-3111
E Mail: sales@mzkworld.com
Web: www.mzkworld.com

McDonald Dash Locksmith Supply Inc.

TN
800-238-7541, 901-797-8000
Fax: 901-366-0005
E Mail: JIMDT@AOL.COM

McManus Locksmith Supply Inc.

NC
800-432-6342 SC 800-438-6567, 704-333-9112 or 704-333-0556
Fax: 704-332-8664
E Mail: mclock@bellsouth.net

Gun Safes

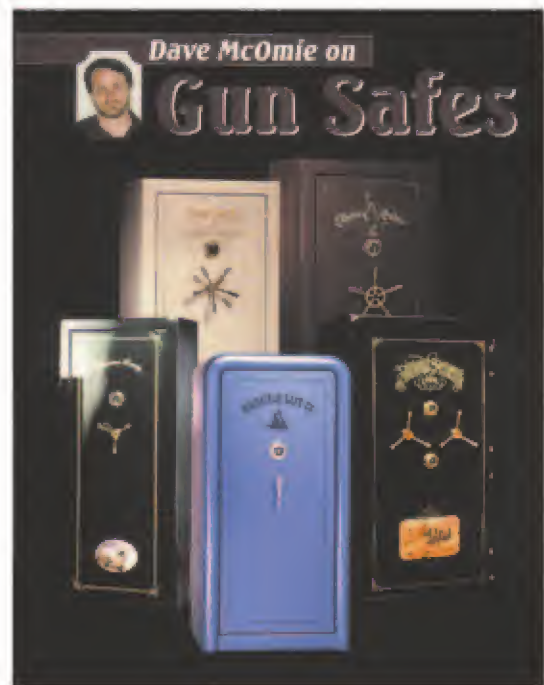

Need a drill point or relocker drill point on a gun safe?

CLICK HERE TO LEARN MORE



#GS - 1

DISTRIBUTORS by PRODUCT

**LOCKING
 PRODUCTS
 (CONTINUED)**

**Mid-South
 Locksmith Supply**
 TN
 800-238-6166, 901-795-6987
 Fax: 901-795-3475 or
 888-795-3475
 E Mail: midsouthlk@aol.com

**National
 Locksmith
 Automobile
 Assn.**

IL
 630-837-2044
 Fax: 630-837-1210
 E Mail: natllock@aol.com
 Web:
 www.TheNationalLocksmith.com

**National
 Locksmith,
 The**

IL
 630-837-2044
 Fax: 630-837-1210
 E Mail: natllock@aol.com
 Web:
 www.TheNationalLocksmith.com

**National
 Safeman's
 Organization**

IL
 630-837-2044
 Fax: 630-837-1210
 E Mail: natllock@aol.com
 Web:
 www.TheNationalLocksmith.com

**Northwest Lock
 & Supply Co.**

OR
 800-359-9425, 541-967-2749
 Fax: 541-928-9338

O'Brien Bros. Inc.

MA
 800-343-0949
 413-734-7121
 Fax: 413-737-1642

**Omaha Wholesale
 Hardware**

NE
 800-238-4566, 402-444-1673
 Fax: 800-538-4566

Pasek Corp.

MA
 800-628-2822, 617-269-7110
 Fax: 617-269-0547 or 800-
 262-0547
 E Mail: PASEK@PASEK.COM

**R & H Wholesale
 Supply Inc.**

CA
 415-863-0404
 Fax: 415-863-7046

**RHS Security
 Hardware**

OH
 880-848-3348, 330-753-3257
 Fax: 303-848-3338

**Rininger Lock
 & Supply**

CA
 619-463-0170
 Fax: 619-697-2590
 E Mail:
 RININGER@ELECTRICITI.COM
 Web: www.ELECTRICITI.COM/
 RININGER

**Robert Skeels
 & Company**

CA
 800-734-4539, 310-639-7240
 Fax: 310-639-7569
 Web: www.SKEELS.COM

**Safemasters
 Company Inc.**

VA
 800-633-9977, 703-256-6402
 Fax: 703-750-1814
 Web: www.safemasters.com

Security Plus Inc.

AZ
 800-426-0200, 602-234-3883
 Fax: 602-234-3882

Security Resources Inc.

FL
 888-801-2003, 850-476-2799
 Fax: 850-476-7410
 Web:
 www.techtrainproductions.com

Serrubec Inc.

Canada
 800-361-0243, 514-631-6791
 Fax: 514-631-0494
 E Mail:
 SERRUBEC@SYMPATICO.CA

**Shield Supply &
 Services Ltd.**

CANADA
 204-774-1921
 Fax: 204-774-5627

**Southern Lock
 & Supply Co.**

FL
 800-282-2837, 727-541-5536
 Fax: 800-447-2299
 E Mail: sales@southernlock.com
 Web: www.southernlock.com

**Stone & Berg Wholesale
 Locksmith Supply**

MA
 800-225-7405, 508-753-3551
 Fax: 800-535-5625
 Web: www.stoneandberg.com

**Taylor Security &
 Lock Co. Inc.**

MD
 800-676-7670, 301-948-7670
 Fax: 301-948-1029
 E Mail: sales@locks.net
 Web: www.locks.net

**Tweeds Security
 Hardware Wholesale**

VA
 800-544-4482, 757-399-2180

Fax: 757-399-1636
 E Mail: tweedslock@aol.com

U.S. Lock Corp.

NY
 800-925-5000, 631-243-3000
 Fax: 631-243-0390
 Web: www.uslock.org

Wacker Hardware

IL
 800-956-3343
 312-733-6070
 Fax: 312-733-7001
 E Mail:
 wackerhardwareco@aol.com

**Wholesale 4
 Inc.**

OR
 800-547-0921, 503-238-8605
 Fax: 503-8139290

Wilco Supply

CA
 800-745-5450, 510-652-8522
 Fax: 510-653-5397
 E Mail: sales@wilcosupply.com
 Web: www.wilcosupply.com

**Worldwide
 Lock Supply
 Inc.**

CA
 800-729-5444, 818-781-9999
 Fax: 818-781-8171

Zipf Lock Co.

OH
 800-848-1577, 614-228-3507
 Fax: 800-228-6320
 E Mail: zipflockco@aol.com
 Web: www.zipflockco.com

**LOCKSMITH
 TOOLS &
 EQUIPMENT**

**Allied Locksmith
 Supply**

OH
 800-544-2102, 330-726-0866
 Fax: 330-726-0865
 E Mail: wiesnercorp@msn.com

AmoraTech Inc.

PA
 717-582-3819
 Fax: 717-582-7549
 Web: www.ballistol-lube.com

Avco Key Supply

NY
 800-332-5397, 516-261-6453
 Fax: 800-329-5397
 E Mail: AVCOKEY@AOL.COM
 Web: www.keyring.com

**Bell's Security
 Sales Inc.**

NJ
 800-772-2266, 973-743-3709
 Fax: 973-743-6357

DISTRIBUTORS by PRODUCT

**Guide to
 Motorcycles**



For years
 locksmith have
 begged for a
 comprehensive
 service manual on
 motorcycles and
 its finally here!

CLICK HERE TO LEARN MORE



#MOT - 2

**LOCKSMITH
 TOOLS &
 EQUIPMENT
 (CONTINUED)**

**Blaydes
 Industries Inc.**

DC
 800-424-2650, 202-832-7100
 Fax: 202-832-1359
 E Mail: blaydesind@msn.com

**Curtis Industries
 A Barnes Distribution
 Company**

OH
 800-555-5397
 Fax: 800-867-6020
 E Mail: kathy.previte@bd-bgi.com
 Web: www.curtisindustries.com

**Cypress Security
 Products Ltd.**

CANADA
 800-561-1967, 403-250-1967
 Fax: 403-250-1969

**DiMark
 International Inc.**

CA
 800-235-2435, 805-922-1182
 Fax: 805-928-8034
 Web: www.pronet.net/dimark

**DRK Specialties
 Keyrings Key
 Blanks & Things**

CA
 800-654-1850, 209-832-4100
 Fax: 888-588-0667

Dugmore and Duncan

MA
 888-384-6673
 Fax: 888-329-3846
 E Mail: sales@dugmore.com
 Web: www.dugmore.com

Enixus Trade Ltd.

CANADA
 905-682-3086
 Fax: 905-682-3086

**Foley Belsaw Co.
 Locksmith Division**

MO
 800-821-3452, 816-483-2700
 Fax: 816-483-5010

Fortress Safe & Lock

OH
 800-562-0295, 513-772-4392
 Fax: 513-326-5983

Gil-Ray Tools Inc.

MI
 517-892-6870
 Fax: 517-892-6870
 E Mail: DJDEUEL@BIGFOOT.COM
 Web: www.angelfire.com/biz/
 gilraytoolsinc/

HMC Int'l Div. Inc.

CO

800-848-4912 ext. 4452
 303-794-2510
 Fax: 303-794-3703

Howard Sales Co.

TX
 800-456-4625, 915-833-7733
 Fax: 915-833-7770
 E Mail: howard@whc.net
 Web: www.howardsales.com

**Independent
 Hardware Inc.**

PA
 800-346-9464, 215-925-5306
 Fax: 215-922-6552
 E Mail: roommate4@aol.com

**Jim Ripley's
 Services Inc.**

OK
 918-341-1077

Keys Plus Distributing

NY
 800-644-5397, 716-743-0220

LDM Enterprises Inc.

CA
 800-451-5950
 Fax: 818-706-8560
 E Mail: LDMINFO@LDMENT.COM
 Web: www.LDMENT.COM

**Locksmith Store Inc.,
 The**

IL
 847-364-5111
 Fax: 847-364-5125
 Web: www.locksmithstore.com

**National Auto Lock
 Service Inc.**

CA
 800-954-5454, 415-757-0700
 Fax: 415-757-9200
 E Mail: sales@laserkey.com
 Web: www.laserkey.com

**National
 Locksmith,
 The**

IL
 630-837-2044
 Fax: 630-837-1210
 E Mail: natlllock@aol.com
 Web: www.TheNationalLocksmith.com

**New York Locksmith
 Supply Co. Inc.**

NY
 212-737-0178, 914-328-1919
 Fax: 212-988-9192

O'Brien Bros. Inc.

MA
 800-343-0949, 413-734-7121
 Fax: 413-737-1642

**Omaha Wholesale
 Hardware**

NE
 800-238-4566, 402-444-1673
 Fax: 800-538-4566

Pasek Corp.

MA
 800-628-2822, 617-269-7110
 Fax: 617-269-0547 or
 800-262-0547
 E Mail: PASEK@PASEK.COM

Pimlico Key Service Inc.

MD
 800-638-3815, 410-367-7400
 Fax: 410-367-7319

Power Company, The

WA
 206-624-5090
 Fax: 206-284-1138
 E Mail: powrcompny@earthlink.net
 Web: www.thepower
 companyinc.com

**R & H Wholesale
 Supply Inc.**

CA
 415-863-0404
 Fax: 415-863-7046

**RHS Security
 Hardware**

OH
 880-848-3348, 330-753-3257
 Fax: 303-848-3338

Secure Industries Inc.

NY
 800-999-2534, 516-433-0033
 Fax: 516-433-8804
 Web: www.secureindust.com

**Security House
 Padlock Distributors**

CANADA
 888-PADLOCKS "Canada
 wide", 905-669-5300
 Fax: 905-660-6313

**Security Lock
 Distributors**

MA
 800-847-5625, 781-444-1155
 Fax: 800-878-6400
 E Mail: SECLOCK@IX
 NETCOM.COM

Security Resources Inc.

FL
 888-801-2003, 850-476-2799
 Fax: 850-476-7410
 Web: www.techtrainproductions.com

**Sentry
 Security
 Fasteners Inc.**

IL
 309-693-2800
 Fax: 309-693-2872 or
 800-693-2872

Septon Inc.

NY
 800-537-8752, 914-246-0638
 Fax: 914-246-3416

**Slide Lock Tool Co. Inc.
 Attn: Z-Tool Division**

TN
 800-336-8812, 865-577-8470
 Fax: 865-577-5936

**Southern Lock
 & Supply Co.**

FL
 800-282-2837, 727-541-5536
 Fax: 800-447-2299
 E Mail: sales@southernlock.com
 Web: www.southernlock.com

DISTRIBUTORS by PRODUCT

**Bread &
 Butter**

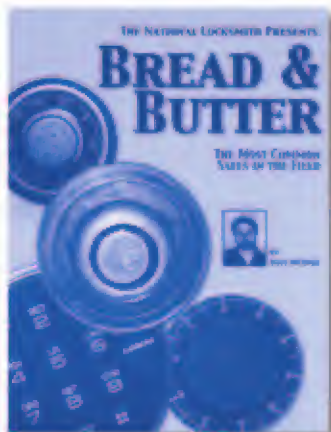

Now here is
 one amazing
 value!

CLICK HERE TO LEARN MORE



#BB - 01

**LOCKSMITH
 TOOLS &
 EQUIPMENT
 (CONTINUED)**

Wacker Hardware
 IL
 800-956-3343, 312-733-6070
 Fax: 312-733-7001
 E Mail:
 wackerhardwareco@aol.com

**WEDGECO
 International**

WA
 800-452-2304
 Fax: 425-646-3569
 E Mail:
 brokenkey@brokenkey.com
 Web: www.brokenkey.com

**Wholesale
 Cylinder Supply**

IN
 877-864-8809, 219-864-8879
 Fax: 219-864-8879
 E Mail: roy-miller@ameritech.net
 Web: www.wcslock.com

Zipf Lock Co.

OH
 800-848-1577, 614-228-3507
 Fax: 800-228-6320
 E Mail: zipflockco@aol.com
 Web: www.zipflockco.com

SAFES & SAFE

PRODUCTS

**Access Safe &
 Supply Ltd.**

Canada
 800-268-9033, 905-795-9802
 Fax: 905-795-9804

**Accredited Lock
 Supply Co.**

NJ
 800-652-2835, 201-865-5015
 Fax: 201-865-5031
 E Mail: mail@accllock.com
 Web: www.accllock.com

**Ace Lock The
 Security People**

PA
 800-824-7712, 412-363-3328
 Fax: 412-363-7540
 E Mail: info@acelockinc.com

**Ace Lock &
 Security
 Supply**

NJ
 800-223-5625, 908-688-7666
 Fax: 908-688-2442
 E Mail: acelock@acelock.com
 Web: www.acelock.com

**Agences W. Pelletier
 (1980) Inc.**

Canada
 800-363-6700, 514-276-6700
 Fax: 514-276-9413
 E Mail: sales@apa-pelletier.com

Web: www.apa-pelletier.com

**Amos Lock & Key
 Supply Co.**

TX
 800-772-7432, 317-335-5397
 Fax: 317-335-5399

Anderson Lock Co.

IL
 800-323-5625, 847-296-1157
 Fax: 847-296-9259
 E Mail: mail@andersonlock.com
 Web: www.andersonlock.com

**Associated Lock
 & Supply**

Canada
 800-668-7161, 604-942-5625
 Fax: 604-942-3761

**Brook's Lock
 & Supply Inc.**

AL
 800-292-5008, 205-353-2596
 Fax: 205-353-8260
 E Mail:
 brooksloc@brookslock.com
 Web: www.brookslock.com

Brooks Wholesale

AL
 800-292-5008
 Fax: 205-353-8260
 E Mail: brooksloc@tiger.net-
 master.net
 Web: www.brookslock.com

City Lock & Safe

CO
 303-444-4407
 Fax: 303-442-8380
 E Mail: Dougsco@aol.com

**Clark
 Security
 Products**

CA
 800-854-2088, 619-505-1950
 Fax: 619-974-5290
 E Mail:
 webmaster@clarksecurity.com
 Web: www.clarksecurity.com

**Colonial Lock Supply
 Co. Inc.**

VA
 800-732-9117, 703-550-8558
 Fax: 703-550-8857

**Commonwealth
 Lock Co.**

MA
 800-442-7009, 617-876-3301
 Fax: 617-661-3168
 E Mail: clc1936@aol.com
 Web: www.commonwealth
 lockco.bizonthe.net

**Craftmaster
 Hardware Co. Inc.**

NJ
 800-221-3212, 201-646-9355
 Fax: 201-646-0181
 E Mail: info@craftmaster.net
 Web: www.craftmaster.net

Doyle Security

Products

MN
 800-333-6953, 612-521-6226
 Fax: 612-521-0166
 Web: www.doylesecurity.com

**E.L. Reinhardt
 Company**

MN
 800-328-1311, 651-481-0566
 Fax: 651-481-0166
 E Mail: elreinhard+@uswest.net
 Web: www.plsgroup.com

**Ewert Wholesale
 Hardware Inc.**

IL
 800-451-0200, 708-597-0059
 Fax: 708-597-0881

Fairway Supply Inc.

TX
 800-776-3247
 Fax: 214-352-4299
 E Mail: fairwayinc@aol.com

Fradon Lock Co. Inc.

NY
 800-447-0591, 315-472-6988
 Fax: 315-472-0958
 E Mail: fradonlock@aol.com

Fried Bros. Inc.

PA
 800-523-2924, 215-627-3205
 Fax: 215-592-1255
 E Mail:
 fbisecurity@fbisecurity.com
 Web: www.fbisecurity.com

**Garden State
 Hardware Wholesalers**

NJ
 800-544-0616, 908-753-1343
 Fax: 908-753-2040

H.E. Mitchell Co.

OR
 800-626-5625, 503-236-9444
 Fax: 503-238-5715

**H.S. & S. Wholesale
 Dist. of Lock Hdwe.**

MI
 800-521-2202, 313-342-6777
 Fax: 313-342-7580

Hahn & Schaffner Inc.

NY
 888-645-8696, 716-928-2850
 Fax: 716-928-2852

**Hans Johnsen
 Co.**

TX
 888-879-1500, 214-879-1550
 Fax: 214-879-1530
 E Mail: LOCKHJC@AOL.COM
 Web: www.hjc.com

Hardware Agencies Ltd.

Canada
 800-268-6741, 416-462-1919
 Fax: 416-462-1922
 E Mail:
 sales@hardwareagencies.com

**Herbert
 Flake Co.**

TX
 800-231-4105, 713-926-3200

DISTRIBUTORS by PRODUCT

**The Best of
 Dale Libby**

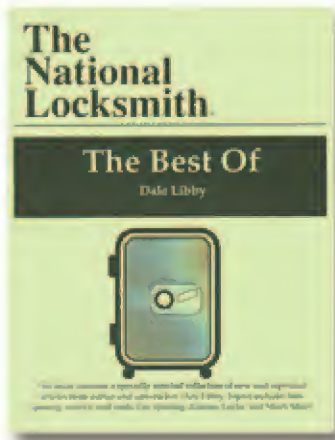

This book includes the best articles written by Dale Libby over the course of many years, going back well over ten years! Now you can have this terrific collection of safe opening articles, automotive articles, and more.

CLICK HERE TO LEARN MORE

#DALE



Fax: 713-926-3399
E Mail: DanF@hlflake.com
Web: www.hlflake.com

**Intermountain
Lock & Supply**

CO
800-323-8046, 303-698-1898
Fax: 303-698-2094

**Island Pacific
Distributors Inc.**

HI
808-955-1126
Fax: 808-946-6480

Jack Stearman Ltd

Canada
604-872-8415, Fax: 604-875-9174

**Jo-Van
Distributors
Inc.**

CANADA
888-752-7210, 416-752-7210
Fax: 888-752-3845
E Mail: sales@jovanlock.com
Web: www.jovanlock.com

KDL Hardware Supply

WA
800-524-9305, 206-682-7383
Fax: 800-524-9305
E Mail: REX@ESKIMO.COM
Web: www.KDLLINK.COM

Key Sales & Supply Co.

MI
800-445-KEYS (5397)
313-931-7720
Fax: 313-931-7758

**Keys Wholesale
Distributors Inc.**

PA
800-292-5397, 610-626-4787
Fax: 610-626-4189

**Kramer Boys
Locksmith Supply**

NJ
800-222-2692, 609-586-0642
Fax: 609-586-0512

**Lockmasters
Inc.**

KY
800-654-0637, 606-885-6041
Fax: 606-885-7093
E Mail: salesinfo@lockmasters.com
Web: www.lockmaster.com

Locks Co.

FL
800-288-0801, 305-949-0700
Fax: 305-949-3619
E Mail: locksco@gate.net
Web: www.locksco.com

LV Sales Inc.

CA
800-894-keys, 323-661-4746
Fax: 323-661-1314
E Mail: sales@lvsales.com
Web: www.lvsales.com

**M. Shepse Co. Div.
American Bionics**

PA
800-666-6007, 412-381-4900

Fax: 412-381-5122

Major Lock Supply

CA
714-447-8363
Fax: 714-447-8393

**Maryland Security
Distributors**

MD
800-390-8889, 410-760-5625

**Mayflower
Sales Co. Inc.**

NY
800-221-2052, 718-622-8785
Fax: 718-789-8346
E Mail: PILGRIM@MFSALES.COM
Web: www.MFSALES.COM

**Maziuk Wholesale
Distributors**

NY
800-777-5945, 315-474-3959
Fax: 315-472-3111
E Mail: sales@mzkworld
Web: www.mzkworld.com

MBA USA, Inc.

KY
888-622-5495, 606-887-0496
Fax: 606-887-9491
E Mail: mbatools@aol.com
Web: www.mbausa.com

**McDonald Dash
Locksmith Supply Inc.**

TN
800-238-7541, 901-797-8000
Fax: 901-366-0005
E Mail: JIMDT@AOL.COM

**McManus
Locksmith
Supply Inc.**

NC
NC 800-432-6342 SC 800-438-6567, 704-333-9112 or 704-333-0556
Fax: 704-332-8664
E Mail: mclock@bellsouth.net

**Mid-South
Locksmith Supply**

TN
800-238-6166, 901-795-6987
Fax: 901-795-3475 or 888-795-3475
E Mail: midsouthlk@aol.com

**National
Locksmith, The**

IL
630-837-2044
Fax: 630-837-1210
E Mail: natlllock@aol.com
Web: www.TheNationalLocksmith.com

**National
Safeman's
Organization**

IL
630-837-2044
Fax: 630-837-1210
E Mail: natlllock@aol.com
Web:

www.TheNationalLocksmith.com

**Northwest Lock
& Supply Co.**

OR
800-359-9425, 541-967-2749
Fax: 541-928-9338

**Orchard Lock
Distributors Inc.**

CT
800-233-2146, 203-865-8106
Fax: 203-624-4083

Rininger Lock & Supply

CA
619-463-0170
Fax: 619-697-2590
E Mail: RININGER@ELECTRICITI.COM
Web: www.ELECTRICITI.COM/
RININGER

**Robert Skeels
& Company**

CA
800-734-4539, 310-639-7240
Fax: 310-639-7569
Web: www.SKEELS.COM

**S.D.I. (Security
Distributors, Inc)**

TX
214-879-1563
Fax: 214-879-1525

**Security House
Padlock Distributors**

CANADA
888-PADLOCKS "Canada
wide", 905-669-5300
Fax: 905-660-6313

Security Plus Inc.

AZ
800-426-0200, 602-234-3883
Fax: 602-234-3882

Serrubec Inc.

Canada
800-361-0243, 514-631-6791
Fax: 514-631-0494
E Mail: SERRUBEC@SYMPATICO.CA

**Shield Supply
& Services Ltd.**

CANADA
204-774-1921
Fax: 204-774-5627

**Stone & Berg Wholesale
Locksmith Supply**

MA
800-225-7405, 508-753-3551
Fax: 800-535-5625
Web: www.stoneandberg.com

**Taylor Security
& Lock Co. Inc.**

MD
800-676-7670, 301-948-7670
Fax: 301-948-1029
E Mail: sales@locks.net
Web: www.locks.net

Timemaster Inc.

KS
888-798-8464
Fax: 800-798-TIME (8463)
E Mail: timstr@aol.com
Web: www.time-master.com

Turn 10 Wholesale

Service

OH
800-848-9790, 740-374-5734
Fax: 800-391-4553

**Tweeds Security
Hardware Wholesale**

VA
800-544-4482, 757-399-2180
Fax: 757-399-1636
E Mail: tweedslock@aol.com

U.S. Lock Corp.

NY
800-925-5000, 631-243-3000
Fax: 631-243-0390
Web: www.uslock.org

Ultra Security

CA
800-698-7477, 858-485-0698
Fax: 858-485-0476

**Wholesale 4
Inc.**

OR
800-547-0921, 503-238-8605
Fax: 503-8139290

Wilco Supply

CA
800-745-5450, 510-652-8522
Fax: 510-653-5397
E Mail: sales@wilcosupply.com
Web: www.wilcosupply.com

**Worldwide
Lock Supply
Inc.**

CA
800-729-5444, 818-781-9999
Fax: 818-781-8171

TNL

DISTRIBUTORS by PRODUCT

SCHOOLS

Academy of Locksmithing, The

2220 Midland Ave. Unit 106
Scarborough Ont., Canada M1P 3E6
888-272-8265
416-321-2220, Fax: 416-321-5115
E Mail: TAOL@PLATINUM1.COM
E. Cole

Acme School Locksmith Division

11350 S. Harlem
Worth, IL 60482
708-361-3750, Fax: 708-448-9306
Course Type: Res.

California Institute of Locksmithing Inc

14721 Oxnard St.
Van Nuys, CA 91411
888-LOCK-411, 818-994-7425
Fax: 818-994-7427
E Mail: friedmancollege@usa.com
Web: www.lock411.com
J. Corey Friedman, Pres.
Course Type: Res Cor

College of Security Technology & Management

1304 Main St.
Grandview, MO 64030
816-765-5551
Fax: 816-765-1777
Web: www.MARKETLYNX.COM/CSTM

Colorado Lks. College Inc.

4991 W. 80th Ave. Unit 103A
Westminster, CO 80030
Howard Smith Pres.

Cothron's School of Professional Locksmithing

509 Rio Grande St.
Austin, TX 78701
888-511-8874
512-472-7844
Fax: 512-479-0953
E Mail: OCOTHRON@AOL.COM
Web: www.cothrons.com
Dan Malin
Course Type: Res.

Foley Belsaw Institute

6301 Equitable Rd.
Kansas City, MO 64120
800-821-3452, 816-483-4200
Fax: 816-483-5010
Web: www.foley-belsaw.com
Tim Compton Inst. Director
Course Type: Cor.

Golden Gate School of Lock Technology

3722 San Pablo Ave.
Oakland, CA 94608
Edwin W.L. Scott Jr.

Granton Institute of Technology

263 Adelaide St. West
Toronto Ont., CANADA M5H1Y3
416-977-3929

Fax: 416-977-5612
E Mail: INFO@GRANTONINSTITUTE.COM
Web: www.GRANTONINSTITUTE.COM
Riyaz Misir Information Officer

Lock Popper School

111 Broadway Ave. #133107
Boise, ID 83702
800-532-5625, 208-861-8003
Fax: 208-424-0258
Web: lockpopper.com
Karlo Maalouf

Lockmasters Security Institute™

5085 Danville Rd.
Nicholasville, KY 40356
800-654-0637, 859-885-6041
Fax: 859-887-0810
E Mail: education@lockmasters.com
Web: www.lockmasters.com
Christa Osborne
Course Type: Res Cor

Locksmithing Institute of Canada

S. Haider Ali
283 Wilson St. East, Suite 101
Ancaster, ONT Canada L9G 2B8
800-589-4201, 905-521-0634
Fax: 905-525-6118
E Mail:
NLA@NATIONALLOCKSMITH.ORG
Web:
WWW.NATIONALLOCKSMITH.ORG
Course Type: Res Cor

Locksmith School Inc.

3901 S. Meridian St.
Indianapolis, IN 46217
317-632-3979
Fax: 317-784-2945
Web: www.locksmithschool.net
Jim Williams Director
Course Type: Res.

LTC Training Center

P.O. Box 3583
Davenport, IA 52808-3583
800-358-9393
319-322-6669
Fax: 319-336-8853
Web: www.LRC-INC.COM
Charlie Pierce
Course Type: Cor

Messick Vo/Tech Center

703 South Greer
Memphis, TN 38111
901-325-4840
Fax: 901-325-4843
Michael M. Sims
Course Type: Res.

North Bennett Street School

39 North Bennet St.
Boston, MA 02113-1998
617-227-0155
Fax: 617-227-9292
Kevin McGinnis Admin. Director
Course Type: Res.

Northern Melbourne Institute of Tafe

Cnr. Bell St. & Waterdale Rd.
Heidelberg West Victoria, Austr. 3081

613-9269-8687
Fax: 613-9269-8673
E Mail: RichardN@NMIT.VIC.EDU.AU
Web: www.nmit.vic.wdu.au/
Max Cherry Locksmith Coord.
Course Type: Res.

Prince George's Community College

301 Largo Rd.
Largo, MD 20774-2199
301-322-0871
Fax: 301-386-7502
E Mail: ourslema@pg.cc.md.us
Web: PGWEB.PG.CC.MD.US
Mary Oursler Program Coordinator
Course Type: Res.

Professional Career Development Institute

430 Technology Lane
Norcross, GA 30092-3406
770-729-8400, Fax: 770-729-9296
Lisa Gray

Red Deer College

Box 5005
Red Deer AB, Canada T4N 5H5
888-475-1101, 403-342-3431
Fax: 403-342-3666
E Mail: shaun.lovell@rdc.ab.ca
Web:
http://www.rdc.ab.ca/rdc/trades/locksmith
Shaun Lovell CJL Instructor
Course Type: Res Cor

School of Lock Technology

1049 Island Ave.
San Diego, CA 92101
619-234-4512, Fax: 619-234-5937
E Mail: GRAH@GRAHSECURITY.COM
Web: www.GRAHSECURITY.COM
Frank Hartung Admin.
Course Type: Res.

School of Security Technology

302 W. Katella Ave.
Orange, CA 92867-4705
800-794-4161
714-633-1366
Fax: 714-633-0199
E Mail: comlock98@earthlink.com
Web: www.locksmith-school.com
heather Coggis, Associate Director
Course Type: Res.

Southern Locksmith Training Institute

1387 Airline Drive
Bossier City, LA 71112
318-227-9458
Fax: 318-746-1734
E Mail: LOCKS1978@AOL.COM
James P. Rushing

Universal School of Master Locksmithing

3201 Fulton Ave.
Sacramento, CA 95821
916-482-4216
Fax: 916-485-9385
Rick Vanina Pres.
Course Type: Res Cor

ALARM MONITORING

Alarm Monitoring Services Inc.

JoAnn Kempff Acct. Coordinator
4821 Hearst St.
Metairie, LA 70001
800-228-4134
504-454-2163
Fax: 504-456-8737
Web: www.monitor1.com

Amcest

Andrew Roberts
1017 Walnut St.
Roselle, NJ 07203

American Magnetics Corporation

Richard Kelley VP - Access Control
740 Watson Center Rd.
Carson, CA 90745-4181

Central Alarm Control Inc.

Robert Boudreaux GM
13973 SW 140 St.
Miami, FL 33186
800-288-6522
305-238-0800
Fax: 305-378-4563

Emergency 24 Inc.

Dante Monteverde Pres.
4179 W. Irving Park Rd.
Chicago, IL 60641

Emergency Response Center

Paul McNeil Sales
1514 E. 191st. Box 17154
Euclid, OH 44117
800-322-3721
216-383-9506
Fax: 800-243-3329

Grand Central Station

Chris D. Rogers
23194 Kidder St.
Hayward, CA 94545
800-230-1654
Fax: 800-230-1653
E Mail: chrisatgcs@aol.com
Web: www.g-c-s.com

IDC

Raymond J. Menard Mktg. Sales Mgr.
1301 E. 79th St.
Minneapolis, MN 55425-1119
800-800-1600
612-854-7058
Fax: 612-854-3342
E Mail: VERICKSON@USINTERNET.COM
Web: www.BESTRESPONSE.COM

N.A.C.C. Inc. (Nat'l Alarm Computer Center Inc)

Mark Schubert Director of Dealer Development
96 Corporate Parkway Suite 300
Irvine, CA 92606
800-482-9800 Ext. 8250
949-851-6222 Ext. 8250
Fax: 949-253-7429
E Mail: mlschubert@securityresource.com
Web: www.SECURITYRESOURCE.COM

National Guardian Security Svc. Corp.

Craig Leiser VP Dealer Op.
43 Main St. SE Ste 303
Minneapolis, MN 55414-1032
800-333-5798
612-336-4360
Fax: 612-333-8358

Security Central

R. Courtney Brown Jr./Operations Mgr.
316 Security Drive P.O. Box 5754
Statesville, NC 28677
800-438-4171
704-838-8000
Fax: 704-878-0309
E Mail: COURTNEYB@SECURITY-CENTRAL.COM
Web: www.SECURITY-CENTRAL.COM

TNL



15 Minute Safe Opening

This book deals exclusively with round head lift out doors. Shows five ways to open a Major; three ways to find the Dog Pin on a Major; four ways to open a Star; four ways to open a LaGard style round head.

CLICK HERE TO LEARN MORE



#JJ - 1

ASSOCIATIONS

American Lock Collectors Assn.

Robert Dix
8576 Barbara Dr.
Mentor, OH 44060
440-257-2346
Fax: 440-257-2373
E Mail: dixlock@aol.com
Web: www.laoc.com

American Society for Industrial Security

F. Joseph Ricci
1625 Prince Street
Arlington, VA 22314
703-519-6200
Fax: 703-519-6299
Web: www.ASISNETONLINE.ORG

Ark-La-Tex Locksmiths Assn.

P.O. Box 44337
Shreveport, LA 71134-4337

Associated Locksmiths of America (ALOA)

Charles W. Gibson Jr., CAE
3003 Live Oak St.
Dallas, TX 75204
214-827-1701
Fax: 214-827-1810
E Mail: aloa@aloea.org
Web: www.aloea.org

Association of Ontario Locksmiths

Don Dekuyper Pres.
2220 Midland Ave. Unit 106
Scarborough Ont., Canada M1P 3E6
416-321-2219
Fax: 416-321-5115
E Mail: taol@platinum1.com
Web: taol.net

BC Association of Professional Locksmiths

Mary Baston
349 W. Georgia St. P.O. Box 2507
Vancouver BC, Canada V6B 3W7
604-291-1180
E Mail: 76730.3573@Compuserve.com

Central States Locksmith Assn.

James Cawby CML CPS
1112 Winchester Rd.
Lexington, KY 40505
859-253-4811
Fax: 859-255-0850
E Mail: locdoc@lex.infi.net
Web: www.grottsecurity.com

Cross Country Motor Club

Grace Coles
4040 Mystic Valley Parkway
Boston, MA 02155

Diamond State Locksmith Assn.

19000 Conrad Street
Wilmington, DE 19805-4245
302-658-7511
Fax: 302-658-7512
E Mail: jphil63661@aol.com
Web: http://members.tripod.com/DSLAA/

Diamond State Locksmith Association

Jonathan Phillips
1900 Conrad Street
Wilmington, DE 19805
302-658-7511

Georgia Chapter ALOA

Stephen L. Gebba CML
P.O. Box 48088
Atlanta, GA 30362
404-455-6244
Fax: 404-455-8080
E Mail: byline@mindspring.com

Grand Canyon Chapter ALOA

E. Kay White CRL
5007 West Pinchot
Phoenix, AZ 85031
602-271-3362
Fax: 602-271-3489
E Mail: skyqueen3@juno.com

Great Plains Locksmith Assn.

James T. Tracy
1214W. 34th
N. Wichita, KS 67204-4237
316-838-5461

Greater Chicago Locksmiths Assoc.

Jeff Trepanier
6216 W. North Ave.
Chicago, IL 60639
312-622-0944
Fax: 708-366-2094
Web:
www.megsinet.com/gela/index.html

Greater Philadelphia Locksmith Assn.

Bob Mock
P.O. Box 1101
Philadelphia, PA 19136
609-845-34-34
Fax: 609-845-3024
E Mail: robertmock@home.com
Web: www.gpla.org

Illinois Locksmith Association

Brent Sheathelm, President
790 Jefferson
Carlyle, IL 62231
618-594-3017

ISC EXPO

Stephanie Juhasz
383 Main Ave.
Norwalk, CT 06851
203-840-5602
203-840-9602
E Mail: sjuhasz@reedexpo.com
Web: http://ilisc.reedexpo.com

Lock Museum of America

Thomas Hennessy
230 Main St.
Terryville, CT 06786
860-589-6359
Fax: 860-589-6359
Web: www.lockmuseum.com

Locksmith Association of CT

Bruce Colgate, Secretary
P.O. Box 202
Old Saybrook, CT 06475
860-668-4837
E Mail: bruce.colgate@snet.net
Web: www.laoc.com

Locksmith Association of Rhode Island

Albert Saart President
PO Box 9181
Providence, RI 02940-9181

Master Locksmith Assn. of New Jersey

Nick Ambrosi CPL
P.O. Box 2441
Morristown, NJ 07960
973-267-8884
Fax: 973-538-2248
E Mail: info@mnanj.org
Web: www.mnanj.org

Middle Tennessee Locksmith Association

Chris Cyree, President
1305 Melrose Street
Tullahoma, TN 37388
931-455-0202
E Mail: ccyree@edge.com

Minnesota Chapter ALOA

David Dalby
14251 Fisher Ave. NE
Prior Lake, MN 55372
612-894-1700
Fax: 612-894-1850

Montana Chapter ALOA

Terry Weggeland
715 West Montana
Kalispell, MT 59901
406-755-4920
E Mail: safetech@centurytel.net

National Burglar & Fire Alarm Assn.

Brad Shipp Exec. Dir.
7101 Wisconsin Ave Ste. 901
Bethesda, MD 20814
301-907-3202
Fax: 301-907-7897
E Mail: staff@alarm.org
Web: www.ALARM.ORG

National Locksmith Association of Canada

S. Haider Ali
283 Wilson St. East, Suite 112
Ancaster, ONT Canada
L9G 2B8
905-521-0634
Fax: 905-525-6118
E Mail:
NLA@NATIONALLOCKSMITH.ORG
Web:
WWW.NATIONALLOCKSMITH.ORG

National Locksmith Automobile Assn.

Marc Goldberg
1533 Burgundy Parkway
Streamwood, IL 60107
630-837-2044
Fax: 630-837-1210
E Mail: natllock@aol.com
Web: www.TheNationalLocksmith.com

National Safeman's Organization (N.S.O.)

Marc Goldberg
1533 Burgundy Parkway
Streamwood, IL 60107
630-837-2044
Fax: 630-837-1210
E Mail: natllock@aol.com
Web: www.TheNationalLocksmith.com

New Hampshire Locksmiths Assn. Inc.

Robert Wyman II
827 Central Ave. PMB 173
Dover, NH 03820-2506
603-743-3336
Fax: 603-737-3195
E Mail: mobilelock@aol.com

New Jersey Locksmiths' Association

Ray Favocci Jr.
P.O. Box 941
Piscataway, NJ 08854
732-780-1550
Fax: 732-780-1553
E Mail: Mrloxxs@aol.com

New York Association of In-House Locksmiths, Inc.

Ralph G. Johnson
PO Box 1439
Madison Square Station
NY, NY 10159
718-997-4451
E Mail: ralph@qc.edu
Web: www.locksmith.org

North Dakota Chapter ALOA

Jim Strong
324 College Dr. S.
Devils Lake, ND 58301
701-662-5625
Fax: 701-662-8127
E Mail: locksmith@stellarnet.com

Northwest Locksmith Assn.

Mike Forbragd CML Pres
5050 State Hwy. 303 Suite109
Bremerton, WA 98311
360-373-5167
Fax: 360-373-8845
E Mail: KEYMAKE@PRODIGY.NET

Nutmeg Chapter of ALOA

Phil's LockShop
360 E. Main St.
Meriden, CT 06450
203-237-4602
Fax: 203-237-1087
E Mail: phil.s.lockshop@snet.net

Web: www.philslock.com

Penn-Ohio Locksmith's Association

Richard Dout, Secretary
1550 Sandy Ln.
Hermitage, PA 16148-6565
724-962-2127
Fax: 724-962-2166
E Mail: ricklock@infonline.net

Pine Tree State Locksmith Assn.

Norman Theriault
79 Chestnut St.
Lewiston, ME 04240
207-647-2926
Fax: 207-647-5299
E Mail: lock@megalink.net

Professional Locksmith Assn. of Alberta

Dave Kennedy Exec. Dir.
Box 68060 Bonnie Doon PO
Edmonton AB, Canada T6C 4N6
403-948-9997
Fax: 403-948-9997
Web: www.plaa.org

Rocky Mountain Locksmiths' Assn.

Kent A. Smith CPL
P.O. Box 2751
Denver, CO 80201
303-347-8770
Fax: 303-347-8771

Ask Dave



You asked. He answered. This is safe and vault Q&A with an attitude.

CLICK HERE TO LEARN MORE



#AD - 1

Safe & Vault Technicians Assn.(SAVTA)

Charles W. Gibson Jr., CAE
3003 Live Oak St.
Dallas, TX 75204
214-827-7233
Fax: 214-827-1810
E Mail: svt@anet-dfw.com
Web: www.SAVTA.ORG

Security Hardware Distributors Association

Patricia A. Lilly
1900 Arch St.
Philadelphia, PA 19103-1498
215-564-3484
Fax: 215-564-2175
E Mail: assnhqt@netaxs.com

Smokey Mountain ALOA

Jessie Swann
2557 Middle Creek Rd.
Pigeon Forge, TN 37863
423-453-8344
Fax: 423-428-2864
E Mail: CICSEC@AOL.COM

South Carolina Locksmith Association

Jean Griggs
P.O. Box 264
Camden, SC 29020
803-432-9008
Fax: 803-424-0450
E Mail: SCLA1@JUNO.COM
Web: www.locksmith.com (under assoc.)

South Jersey Locksmiths Assn.

John N. McCleery CML sec.
P.O. Box 113
Birmingham, NJ 08011-0113
609-648-9065
Fax: 609-653-5869
E Mail: RICKSS@SNIP.NET

Southern Indiana Chapter ALOA

Lloyd Graham
P.O. Box 133
Huntingburg, IN 47542
812-683-5245
E Mail: elgee@faci.net

Tennessee Organization of Locksmiths (Tools)

Tom Gilligan, CLP - President
P.O. Box 733
Antioch, TN 37011-0733
E Mail: gillinghan.clp@nashville.com

Texas Locksmith Association

Mike Clark
P.O. Box 240937
San Antonio, TX 78224-0937
210-923-4381
Fax: 210-977-8398

The Door & Hardware Institute

Jerry Heppes CAE
14150 Newbrook Dr. Suite 200
Chantilly, VA 20151-2232
703-222-2010
Fax: 703-222-2410
E Mail: jheppes@dhi.org
Web: www.dhi.org

Wyoming Locksmith Association

J. Allen McCumber CPL
1026 Alger Ave.
Cody, WY 82414
307-587-3035
Fax: 307-587-3035

Yankee Security Convention

Robert Mahoney President
P.O. Box 70
Medford, MA 02155
800-209-8266
Fax: 781-345-0634
Web: www.yankeeconvention.com

TNL

ASSOCIATIONS



#ALS - 1

Auto Lock Service

Covers opening and service techniques.

[CLICK HERE TO LEARN MORE](#)



WEB SITES

ALARM

Alarm Monitoring Services Inc.

www.monitor1.com

Grand Central Station

www.g-c-s.com

IDC

www.BESTRESPONSE.COM

N.A.C.C. Inc. (Nat'l Alarm Computer Center Inc)

www.SECURITYRESOURCE.COM

Security Central

www.SECURITY-CENTRAL.COM

ASSOCIATIONS

American Lock Collectors Assn

www.laoc.com

American Society for Industrial Security

www.ASISNETONLINE.ORG

Associated Locksmiths of America (ALOA)

www.aloa.org

Association of Ontario Locksmiths

taol.net

Central States Locksmith Assn.

www.grottsecurity.com

Diamond State Locksmith Assn.

<http://members.tripod.com/DSLAI/>

Greater Chicago Locksmiths Assoc.

www.megsinet.com/gela/index.html

Greater Philadelphia Locksmith Assn.

www.gpla.org

ISC EXPO

<http://ilisc.reedexpo.com>

Lock Museum of America

www.lockmuseum.com

Locksmith Association of CT

www.laoc.com

Master Locksmith Assn. of New Jersey

www.mlanj.org

National Burglar & Fire Alarm Assn.

www.ALARM.ORG

National Locksmith Automobile Assn.

www.TheNationalLocksmith.com

National Safeman's Organization (N.S.O.)

www.TheNationalLocksmith.com

New York Association of In-House Locksmiths, Inc.

www.locksmith.org

Nutmeg Chapter of ALOA

www.philslock.com

Professional Locksmith Assn. of Alberta

www.plaa.org

Safe & Vault Technicians Assn.(SAVTA)

www.SAVTA.ORG

South Carolina Locksmith Association

www.locksmith.com (under assoc.)

The Door & Hardware Institute

www.dhi.org

Yankee Security Convention

www.yankeeconvention.com

DISTRIBUTORS

Access Hardware Supply

www.ACCESSHARDWARE.com

Accredited Lock Supply Co.

www.acclock.com

Ace Lock & Security Supply

www.ACELOCK.COM

Agences W. Pelletier (1980) Inc.

www.apa-pelletier.com

Akron Hardware Consultants

www.akronhardware.com

AmoraTech Inc.

www.ballistol-lube.com

Anderson Lock Co.

www.andersonlock.com

Andrew's Wholesale Lock Supply

www.andrewslock.com

ASLA Distributing

www.asla-distributing.com

Avco Key Supply

www.keyring.com

Boyle & Chase Inc.

www.boyleandchase.com

Brook's Lock & Supply Inc.

www.BROOKSLOCK.COM

Charman Enterprises

www.charment.com

Clark Security Products

www.clarksecurity.com

Commonwealth Lock Co.

www.commonwealthlockco.bizonthe.net

Craftmaster Hardware Co. Inc.

www.craftmaster.net

Curtis Industries A Barnes Distribution Company

www.curtisindustries.com

Defiant Safe Co. Inc.

www.defiantsafe.com

DiMark International Inc.

www.pronet.net/dimark

DL Services

www.domsecurity.com

Door Hardware Distributors Inc.

www.doorhardware.net

Doyle Security Products

www.doylesecurity.com

Dugmore and Duncan

www.dugmore.com

E.L. Reinhardt Company

www.plsgroup.com

Encon Electronics

www.enconelectronics.com

Fried Bros. Inc.

www.fbisecurity.com

Gil-Ray Tools Inc.

www.angelfire.com/biz/gilraytoolsinc/

H & H Lock & Security Wholesalers

www.hhlock.com

Hans Johnsen Co.

www.hjc.com

Hardinge Bros. Limited

www.cansecure.com

Hawley Lock Supply

www.hawleylock.com

Herbert Flake Co.

www.hflake.com

Howard Sales Co.

www.howardsales.com

International Distribution Network

www.idn-inc.com

J. Nathan Hardware Specialties Inc.
www.jnathan.com

JLM Wholesale Inc.
www.jlmwholesale.com

Jo-Van Distributors Inc.
www.JOVANLOCK.COM

KDL Hardware Supply
www.KDLLINK.COM

LDM Enterprises Inc.
www.LDMENT.COM

Lockmasters Inc.
www.lockmaster.com

Locks Co.
www.LOCKSCO.COM

Locksmith Store Inc., The
www.locksmithstore.com

LV Sales Inc.
www.lvsales.com

Martco
www.martcoinc.com

Mayflower Sales Co. Inc.
www.MFSALES.COM

Maziuk Wholesale Distributors
www.mzkworld.com

MBA USA, Inc.
www.mbausa.com

MD Wholesale Hardware
www.mdhardware.com

Monaco Lock Company Inc.
www.monacolock.com

National Auto Lock Service Inc.
www.laserkey.com

National Locksmith, The
www.TheNationalLocksmith.com

Ohio Travel Bag Mfg. Co.
www.ohiotravelbag.com

Padlocks4less.com
www.padlocks4less.com

Perry Blackburne Inc
www.perryblackburne.com

Power Company, The
www.thepowercompanyinc.com

Pride Barco Lock Company
http://mindspring.net/npride.barco/

RA-Lock Company
www.rlindustries.com

Richardson Electronics Ltd.
www.rell.com

Rininger Lock & Supply
www.ELECTRICITI.COM/RININGER
Robert Skeels & Company
www.SKEELS.COM

Safemasters Company Inc.
www.safemasters.com

Secure Industries Inc.
www.SECURE INDUST

Security Resources Inc.
www.techtrainproductions.com

ShurLok Key Storage
www.ShurLok-Products.com

Silver Sales
www.silversalesusa.com

Southern Lock & Supply Co.
www.southernlock.com

Stone & Berg Wholesale Locksmith Supply
www.stoneandberg.com

Taylor Security & Lock Co. Inc.
www.locks.net

Timemaster Inc.
www.TIME-MASTER.COM

Top Notch Distributors
www.4topnotch.com

U.S. Lock Corp.
www.uslock.org

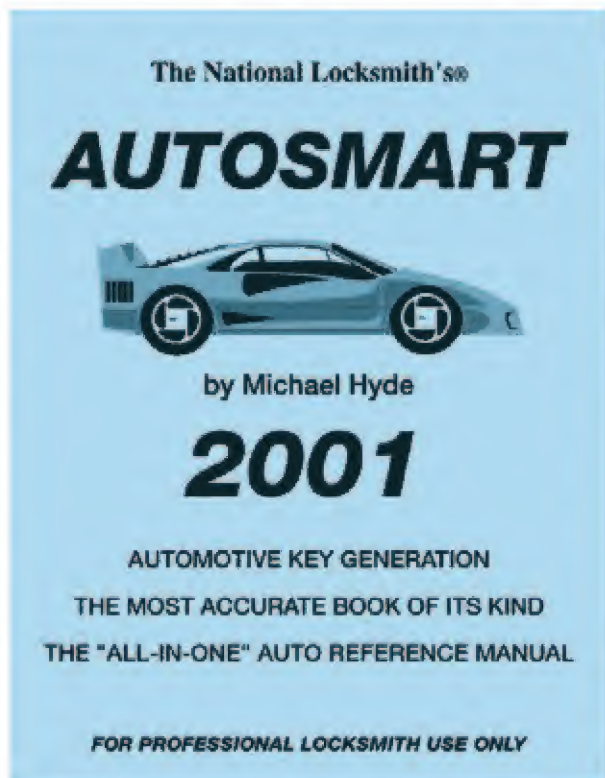

AutoSmart

A MUST
for every
locksmith!



CLICK HERE TO LEARN MORE

DISTRIBUTORS (CONTINUED)

WEDGE CO International

www.brokenkey.com

Westguard Inc.

www.westguard-inc.com

Wholesale Cylinder Supply

www.wcslock.com

Wilco Supply

www.wilcosupply.com

Zipf Lock Co.

www.ZIPFLOCKCO.com

MANUFACTURERS

A&B Safe Corp.

www.A-BSAFECORP.COM

ABH Manufacturing

www.abhmfg.com

Abloy Door Security

www.abloy.com

Abus Lock Co.

www.abus.com

Access Denied Inc.

www.ultradog.com

Access Hardware Supply Inc.

www.accesshardware.com

Accu-Lock Inc.

www.acculock.com

Accurate Lock & Hardware Co.

www accuratelockhardware.com

Adams Rite Manufacturing Co.

www.Adamsrite.com

Adapt-A-Bore^a

www.doorhardware.net

Adesco Safe Mfg. Co.

www.adesco.com

Adrian Steel Co.

www.adriansteel.com

Advanced Hardware Technologies

www.TRANSATLANTICCO.COM

Aero Lock

www.aerolock.com

Aiphone Intercom Systems

www.aiphone.com

Alarm Lock Systems Inc.

www.alarmlock.com

AlarmSaf

www.alarmsaf.com

All-Safe Security Systems Ltd.

www.allsafesec.com

Allstate Insurance Co.

www.allstate.com

122 • The National Locksmith

America Key Boxes

www.keyboxes.com

American Auto Accessories Inc.

www.3aracing.com

American Lock Co.

www.americanlock.com

American Security Products Co.

www.amsecusa.com

American Tolkey & Die

www.tolkey.com

Amoratech Inc.

www.balliston-lube.com

AMSECO

www.amseco-kai.com

APR Industries Inc.

www.Aprusa.com

ASSA

www.assalock.com

Auto-Security Products (ASP Inc.)

www.carlocks.com

AutoSmart Advisor

www.AutoSmartAdvisor.com

Badge-A-Minit

www.badgeaminit.com

Baton Lock & Hardware Co. Inc.

www.batonlockusa.com

BiLock North America Inc.

www.bilock.com

Blackhawk Products

www.blackhawk7.com

Boggs Tool Processing & File Sharpening Co.

www.BoggsTool.com

Buddy Products Locksmith Division

www.buddyontheweb.com

CalRoyal Products

www.car-royal.com

Cannon Safe Inc.

www.CANNONSAFE.COM

Cansec Systems Ltd.

www.cansec.com

Cargolock

www.cargolock.com

CCL Security Products

www.cclsecurity.com

Chicago Lock Co. One of Comx International Companies

www.nelnet.com

ClearStar Security Network

www.clearstar.com

CodePro Manufacturing

www.arclock.com

Computer Reset

www.c-reset.com

Computerlock Anti-Theft Devices

www3.bc.sympatico.ca/cyberlock

COMPX SECURITY PRODUCTS

www.nclnet.com

Control Monitor Systems

www.controlmonitor.com

Corkey Control Systems Inc.

www.corkey.com

Creative Commands Corp.

www.handytouch.com

Cypress Computer Systems, Inc

www.cypresscom.com

DALAX Inc. / H&L Simon Co.

www.simon-says.net

Darex Corp.

www.darex.com

Data-Basics

www.databasic.com

Decoy Safe Co.

decoysafe.com

Dejoux Enterprises

www.causekeys.com

Detex Corp.

www.detex.com

DLA Security Systems Inc.

www.dlaco.com

Domino Engineering Corporation

www.dominoengineering.com

Door Controls Int'l.

www.doorcontrols.com

Doorguard Systems Inc.

www.doorguardsystems.com

DoorKing Inc.

www.doorking.com

Dorma Architectural Hardware/The DORMA Group N. A.

www.dorma-usa.com

Dynalock Corporation

www.dynalock.com

Eclipse, Inc.

www.eclipseinc.com

Engineering Solutions Inc

www.engsolinc.com

Escalera Inc.

www.escalera.com

Eternity Security Systems, Inc.

www.eternalock.com

Everswitch

www.barantec.com

Falcon Lock

www.falconlock.com

Fort Knox Security Products

www.ftknox.com

Fort Lock Corp.

www.fortlock.com

Framon Manufacturing Company Inc.

www.framon.com

Fred Silver Company

www.fredsilver.com

Frontier Safe Co.

www.frontiersafe.com

Gardall Safe Corp.

www.gardall.com

Gator Tools

www.aduxpond.com

Gil-Ray Tools Inc.

www.angelfire.com/biz/GilRayToolsInc/

Graffunder

www.eoni.com/~grafsafe

Granite Security Products Inc.

www.graniteSafe.com

GTO Inc.

www.gtoinc.com

G-U Hardware Inc.

www.g-u.com

Gun Vault

www.gunvault.com

Hammerlock Industries

www.HAMMERLOCK.COM

Hampton Products International

www.hamptonproducts.com

Hardware Technologies Ltd.

www.us.hoppe.com

Harrison Electronic Systems

www.harrison-hellfire.com

Hayman Safe Co. Inc.

www.haymansafe.com

Henry A. Evers Corp.

www.henryaevers.com

Hercules Industries Inc.

www.brass-padlocks.com

HES Inc.

www.hesinnovations.com

High Tech Tools

www.hightechnools.com

Hirsch Electronics Corporation

www.hirschelectronics.com

HPC Inc.

www.hpcworld.com

Ilco Unican Corp. UNICAN Lock Division

www.ilcounican.com

Ilco Unican/Electronic Access Control Div.

www.ilcounican.com

Illinois Lock Co./Div. of The Eastern Co

www.illinoislock.com

Indiana Cash Drawer Co.

3www.icdpos.com

Industries CL Inc

www.legault-locks.com

Innovative Moving Systems Inc.

www.lectrotruck.com

InstaCode 200 I

www.TheNationalLocksmith.com

Intellikey Corporation

www.intellikey.com

Interactive Technologies Inc.

www.ititechnologies.com

International Locking Devices Ltd.

www.gatelock.com

Intralock Tools Ltd.

www.intralocktools.com

Jado Bathroom & Hardware Mfg. Corp.

www.jado.com

Jensen Tools Inc.

www.jensentools.com

Jet Hardware Mfg. Corp.

www.jetkeys.com

Kaddies Inc.

www.kaddiesinc.com

10 Years of Dave McOmie

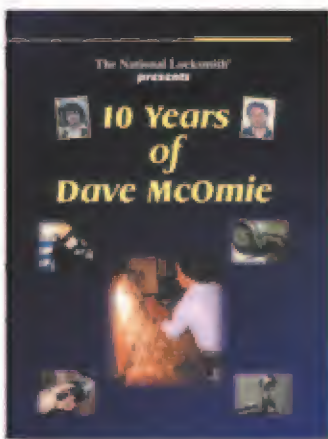

CLICK HERE TO LEARN MORE



#DM - 10

Ford 8 Cut Decoding Key Set



CLICK HERE TO LEARN MORE



#FD - 8

WEB SITES

MANUFACTURERS (CONTINUED)

Keedex Inc.

www.keedex.com

Kenstan Lock & Hardware Co.

www.kenstan@kenstan.com

Keri Systems Inc.

www.kerisys.com

Key Systems Inc.

www.keystorage.com

KEY-BAK; Div. of West Coast Chain Mfg. Co.

www.keybak.com

KeySoft Masterkeying Software

www.masterkeypro.com

Keysure

www.keysure.net

Knaack Mfg. Co.

www.weatherguard.com

Knight Safe Mfg.

www.knightsafemfg.com

Knox Company

www.knoxbox.com

Kouba & Associates Inc.

www.koubasystems.com

Kustom Key Inc.

www.kustomkey.com

Kwikset Corporation - A Black & Decker Comp.

www.kwikset.com

L&S Security Products

members.aol.com/lsssecprod/index.html

La Gard Inc.

www.LAGARD.COM

LAB Security

www.lab-lockpins.com

Lectro Truck/IMS

www.lectrotruck.com

Liberty Lock & Safe

www.libertylock.com

Liberty Safe & Security Products Inc.

www.libertysafe.com

Lifetime Products

www.lift-a-load.com

Lockbutler, SBD Inc.

www.lockbutler.com

Locksmith Dispatcher 2000

www.DiamondSoftwareSystems.com

Locksmith.com

www.locksmith.com

Locksoft Inc.

www.locksoft.com

Lori Lock

www.lorilock.com

Lucky Line Products Inc.

www.luckyline.com

M.A.G. Eng. & Mfg. Inc.

www.magsecurity.com

M.K. Morse Company

www.MKMORSE.COM

Magnokrom Inc.

www.magnokrom.com

Major Manufacturing Inc.

www.majormfg.com

Major Metalfab Inc. (MMF)

www.mmfind.com

Markar Products Inc.

www.markar.com

MARKS U.S.A.

www.marksusa.com

Marlee Electronics

www.kerisys.com

Marray Enterprises Inc

www.marray.com

Mas Hamilton Group Inc.

www.mas-hamilton.com

MBI Business Software

www.mbisoft.com/locksmith.HTM

McGunn Safe Co. L.L.C.

www.mcgunnsafe.com

MDS (Medical Diagnostics Services Inc.)

www.medsincorporated.com

Medeco Security Locks Inc.

www.medeco.com

Meilink Safe Co.

www.meilinksafe.com

Miwa Lock USA

www.mivalockusa.com

Monarch Hardware & Mfg. Co.

www.monarchhardware.com

Monarch Tool and Mfg. Co. Inc.

www.monarchcoin.com

Morning Industries

www.morningindustries.com

Mosler Inc

www.mosler.com

Mr. Chime Inc.

www.mrchime.com

Multi Lock Inc.

www.multilock.com

Multi-Lock Corporation

www.security-multilock.com

Mul-T-Lock USA Inc.

www.Mul-T-Lock.com

Mutual Safe Company

www.mutualsafes.com

National Locksmith

www.TheNationalLocksmith.com

National Locksmith, The

www.TheNationalLocksmith.com

National Safemans Organization

www.TheNationalLocksmith.com

NEBS Inc.

www.nebs.com

Next Generation Tool Co.

www.nextgentool.com

Numberall Stamp & Tool Co. Inc.

www.numberall.com

NU-SET LOCK

www.nuset.com

Olympus Lock Inc.

www.olympus-lock.com

OSI Security Devices

www.omnilock.com

P.E. Fraser Inc.

www.mediom.qc.ca/~fraser

Pacel Corp

www.pacel.com

Padlocks 4 less

www.padlocks4less.com

Paktek Inc.

www.toolpak.com

Palmer Security Products Inc.

www.palmersecurity.com

Papaiz U.S.A. Ltd.

www.papaizlocks.com

PC Guardian (Computer Security Products)

www.pcguardian.com

PCSC

www.1PCSC.COM

PDQ Industries

www.pptnet.com/pdq

PEMCO Mfg. Co.

www.pemko.com

Perma Vault Safe Corp.

www.PERMA-VAULT.COM

Phoenix Industries Inc

www.ndiyp.com

PPM 2000 Inc.

www.ppm2000.com

RCI Rutherford Controls International Corp.

www.rutherfordcontrols.com

Reading Body Works

www.readingbody.com

**ROFU
International
Corp.**

www.rofu.com

Roto Zip Tool Corp.

www.rotozip.com

Rytan Inc.

www.rytan.com

**S. Parker Hardware Mfg.
Corp.**

www.Sparker.com

Saf T Lok

www.saf-t-lok.com

Safe-O-Mat Deposit Locks

www.safeomat.com

**Safety Technology
International Inc.**

www.sti-usa.com

SAFLOK

www.winfieldlock.com

Salsbury Industries

salsbury.com

Sandstrom Products Co.

WWW.sandstromproducts.com

**Sargent &
Greenleaf Inc.**

sglocks.com

**Sargent
Manufacturing Co.**

www.sargentlock.com

**Schlage Commerical Lock
Division**

www.schlage.com

Schwab Corp.

www.schwabcorp.com

Schwenk Lock

www.schwenkco.com

SECO-LARM USA INC.

www.seco-larm.com

Secura Key

www.securakey.com

**Securex Americas Div. Of
Incas Safe Corp.**

www.inkas.com

Securitech Group Inc.

www.securitech.com

Securitron Magnalock Corp.

www.securitron.com

**Security Distributors
Incorporated**

www.uscanlock.com

Security Door Controls

www.sdcsecurity.com

Security Latch

www.securitylatch.com

**Se-Kure Controls
Inc.**

www.se-kure.com

Select Products Limited

www.select-hinges.com

Sentex Systems Inc.

www.sentexsystems.com

**Sentinel Diversified
Industries, Inc.**

www.l-sdi.com

Sentry Group

www.sentrysafe.com

Sentrylok Corp.

www.sentrylok.com

**ShatterGard Security Window
Films**

www.shattergard.com

Sieveking Products Co.

www.sievekingprodco.com

Slydelock

www.slydelock.com

Speedypik Corp.

www.speedypik.com

Streamlight Inc.

www.streamlight.com

Subterranean Data Storage

www.sdsvaults.com

Sunroc Telkee

www.telkee.com



AutoSmart Advisor

Contains
virtually
every car
and part
known to
man up
through
2000.

CLICK HERE TO LEARN MORE



#ASA - 2000

December 2000 • 125

WEB SITES

Diary Of A Safeman



This book is a real gem...the private safe diary of old time safecracker C.L. Corey.

CLICK HERE TO LEARN MORE



#DIARY

MANUFACTURERS (CONTINUED)

Supra Products

www.supra-products.com

Synco Chemical Corp

www.super-lube.com

Synergistics

www.SYNERGISTICSINC.COM

Tanner Bolt & Nut Corp.

www.tannerbolt.com

Taylor building products, Inc.

www.taylor-door.com

Tech-Train Productions

www.techtrainproductions.com

Tektone Sound & Signal Mfg.

www.tektone-sound.com

Thorvie International

www.Thorvie.com

Timberline Lock Ltd.

www.timberlinelock.com

Timemaster Inc.

www.time-master.com

Trans-Atlantic Company

www.transatlantic.com

Treskat USA

www.TRESKAT.COM

Trimec

www.trimec-usa.com

Trine Access Technology

www.trineonline.com

Tripp Lite

www.triplite.com

Tru Hone Corporation

www.truhone.com

Truecraft Tools

www.truecrafttools.com

Tufloc

www.esmet.com

Tufloc Mfg. by Esmet

www.ESMET.com

U-Change Lock Industries Inc.

www.u-change.com

United Business Computers

www.ubcinc.com

Universal Industrial Products Co.

www.soss.com

Unlocks Inc.

www.1-800-unlocks.com

Videx

www.videx.com

Vigilante Burglar Bars Inc.

www.vigilock.com

Visonic Inc.

www.visonic.com

Walvaults Inc.

www.rsfab.com

WD-40 Co.

www.wd40.com

Wilson Safe Co.

www.wilsonsafe.thomasregister.com

W-LOK

www.wlokcorp.com

XL Lock Mfg.

www.xllock.com

Yale Security Group Inc.

www.yalesecurity.com

Yortec Inc.

www.yortec.com

Young Bros. Stamp Works

www.youngbrosstampworks.com

Zero International Inc.

www.interport.net/zero

SCHOOLS

California Institute of Locksmithing Inc

www.lock411.com

College of Security Technology & Management

www.MARKETLYNX.COM/CSTM

Cothron's School of Professional Locksmithing

www.cothrons.com

Foley Belsaw Institute

www.foley-belsaw.com

Granton Institute of Technology

www.GRANTONINSTITUTE.COM

Lock Popper School

lockpopper.com

Lockmasters Security Institute TM

www.lockmasters.com

Locksmith School Inc.

www.locksmithschool.net

LTC Training Center

www.LRC-INC.COM

Northern Melbourne Institute of Tafe

www.nmit.vic.wdu.au

Prince George's Community College

PGWEB.PG.CC.MD.US

Red Deer College

http://www.rdc.ab.ca/rdc/trades/locksmith

School of Lock Technology

www.GRAHSECURITY.COM

School of Security Technology

www.locksmith-school.com

INL

the national locksmith 2000 Price Survey

It's that time again when you get a chance to see where you rank as far as what you charge for services rendered according to the national average. Remember that this is only an average for common services performed. Your physical location will greatly effect the charges you can demand. The purpose of this price survey is not to tell you what you should be charging. This chart is to let you know if your business is operating on the "high" side, "low" side or "about average" in comparison to your fellow locksmiths from around the country.

Shopwork	Average	High	Low	Last Year
Service Call	\$35.25	\$70.00	\$20.00	\$32.77
Hourly Rate	\$48.40	\$75.00	\$25.00	\$47.45

Key Duplicating	Average	High	Low	Last Year
American Single Cut	\$2.27	\$12.00	\$1.50	\$2.00
American Double Cut	\$3.11	\$16.00	\$1.75	\$2.97
Foreign Single Cut	\$3.17	\$12.00	\$1.50	\$2.65
Foreign Double Cut	\$3.51	\$16.00	\$2.00	\$3.46
Flat Steel	\$5.07	\$12.50	\$3.00	\$4.11
Flat Steel Double Cut	\$4.94	\$9.50	\$4.00	\$4.73
Tubular	\$4.67	\$12.00	\$3.00	\$4.49
Bit Key	\$8.46	\$15.00	\$3.50	\$7.44
Safe Deposit Box	\$9.75	\$20.00	\$4.00	\$9.15
High Security	\$10.25	\$15.00	\$7.00	\$8.25
Best	\$3.53	\$7.25	\$1.70	\$3.40
Key From Broken Original	\$5.78	\$30.00	\$1.50	\$5.78

Re-Key/Change Combination/ First Key (In Shop Price)	Average	High	Low	Last Year
Key-in-Knob	\$9.98	\$25.00	\$6.00	\$9.94
Rim or Mortise Cylinder	\$9.89	\$25.00	\$6.00	\$9.89
Rim or Mortise Cylinder High Sec.	\$17.58	\$28.00	\$6.00	\$17.40
Pick Open Cylinder	\$8.90	\$30.00	\$5.00	\$8.60
Each Additional Key	\$3.25	\$12.00	\$1.50	\$3.30
Bit Keys	\$12.68	\$30.00	\$4.50	\$13.74
Best	\$15.07	\$25.50	\$5.50	\$14.14
Safe Deposit Box	\$18.32	\$45.00	\$7.00	\$18.17
Locker Lock	\$14.69	\$30.00	\$7.50	\$14.69
Tubular Lock	\$16.32	\$35.00	\$8.50	\$16.11

Auto Locks	Average	High	Low	Last Year
Fit Key to GM Vats	\$141.73	\$300.00	\$95.00	\$139.43
Pull GM Steering Wheel In Shop	\$45.50	\$125.00	\$30.00	\$45.32
Airbag	\$75.69	\$150.00	\$50.00	\$77.69
Telescoping Wheel	\$61.00	\$125.00	\$25.00	\$57.00
Obsolete Auto Lock	\$35.80	\$65.00	\$25.00	\$31.64
Foreign Door and Trunk	\$38.92	\$65.00	\$25.00	\$36.62
Foreign Ignition	\$47.15	\$90.00	\$25.00	\$43.75
Motorcycle	\$35.01	\$85.00	\$20.00	\$36.81
Open Vehicle	\$36.50	\$75.00	\$10.00	\$38.84

Make First Key by Code	Average	High	Low	Last Year
American Single Cut	\$10.12	\$40.00	\$4.00	\$11.69
American Double Cut	\$13.49	\$48.00	\$5.00	\$13.26
Foreign Single Cut	\$13.65	\$30.00	\$4.00	\$12.65
Foreign Double Cut	\$12.24	\$30.00	\$5.00	\$13.94
Foreign Sidewinder	\$48.80	\$75.00	\$15.00	\$45.20
Flat Steel	\$15.07	\$42.00	\$7.50	\$17.77
Flat Steel Double Cut	\$20.99	\$48.00	\$9.00	\$20.59
Suitcase/Briefcase	\$12.27	\$25.00	\$5.00	\$11.27
Tubular	\$19.76	\$45.00	\$10.50	\$18.16
Safe Deposit Box	\$25.55	\$45.00	\$15.00	\$22.75
Motorcycle	\$16.07	\$35.00	\$5.00	\$13.27

First Key	Average	High	Low	Last Year
By Impression	\$24.27	\$55.00	\$10.00	\$21.27
By Reading	\$20.75	\$55.00	\$10.00	\$20.72

Padlocks	Average	High	Low	Last Year
Combination by Code	\$9.67	\$25.00	\$2.00	\$6.77
First Key Pin Tumbler	\$10.02	\$25.00	\$4.00	\$12.42
First Key Wafer	\$12.49	\$25.00	\$4.50	\$11.89
Pin Tumbler by Code	\$8.18	\$25.00	\$4.50	\$8.58
Key Stamping Per Line	\$0.74	\$7.50	\$1.00	\$0.96
Best First Key	\$15.88	\$30.00	\$5.00	\$14.83
High Security First Key	\$24.71	\$45.00	\$10.00	\$23.21

Door Closers	Average	High	Low	Last Year
Repack and Refill Overhead	\$74.25	\$80.00	\$35.00	\$61.25
Floor Check	\$55.50	\$85.00	\$45.00	\$50.00

Safes	Average	High	Low	Last Year
Drill Locked Safe	\$152.66	\$500.00	\$50.00	\$166.06
Manipulate Locked Safe	\$125.94	\$250.00	\$50.00	\$134.64
Change Combo (Key Change)	\$35.77	\$65.00	\$10.00	\$32.77
Change Combo (Hand Change)	\$34.41	\$70.00	\$15.00	\$38.01
Door Repair	\$82.48	\$95.40	\$25.00	\$63.16
Move Safe	\$146.31	\$200.00	\$75.00	\$140.71



BUSINESS BRIEFS

Ingersoll-Rand Elects VP of Investor Relations & Communication

Ingersoll-Rand Company has appointed Matthew T. Farrell to the new position of vice president, investor relations and communication. In this capacity, Farrell will head Ingersoll-Rand's investor relations, public affairs and media and government relations programs, and will oversee its employee communications and corporate identity initiatives.

For more information visit them on the web at www.ingersoll-rand.com or circle 352 on Rapid Reply.

Aiphone Corporation Receives ISO-9002 Certification

Aiphone Corporation recently received ISO-9002 certification for their Quality Management System. ISO-9002 is part of a series of voluntary standards and guidelines formulated by the International Organization for Standardization (ISO) to help companies set up quality systems for the production, installation, testing, inspection and servicing of products. Its primary purpose is to provide suppliers with useful internationally recognized guidelines and models for operating a quality management system. The quality management system assures that companies with ISO certification provide quality, consistent, reliable, value added customer orientated products and services.

Monaco Millennium Edition Catalog

Monaco Lock Company, Inc. is proud to announce the release of its new volume 12 full-line catalog entitled the Millennium Edition. This catalog contains security

products for the 21st century and is available in print or a digital version on CD. The CD catalog will help you find products by manufacturer with greater ease and in less time. Individual pages may be printed directly from your computer screen.

For your complimentary copy call: (800) 526-6094 Ext. 154.

Security Lock Issues Ingersoll-Rand Price Book

Complete pricing information on Schlage, Von Duprin and LCN mechanical and electrical security products is now available in a single reference guide. In addition to prices, the book contains product description and features, functions, dimensions, options, accessories and complete ordering information.

For your free copy call: (800) 847-5625; Fax: (800) 878-6400.



LTC Training Center CCTV Certification Programs

LTC Training Center announces the latest addition to their educational programs. Two brand new and completely revised CCTV certification programs have been implemented. These two series train the user for all aspects of closed circuit television from basic



video theory to site assessment and system troubleshooting. Companies can train from one to one hundred using the certification programs' proven methods. Each program comes complete with a VHS instructional series, corresponding manual and a follow up comprehensive test. LTC Training Center will grade each test upon completion and provide a wooden plaque and certificate for a passing grade of 75% or higher.

There are two different educational tracks to choose from; installation/field service of CCTV or application and design of CCTV.

For more information contact: Joe Schaechtter, LTC Training Center, 930 S. Rolff Street, Davenport, IA 52802; Phone: (319) 322-6669; Fax: (319) 336-8853 or circle 353 on Rapid Reply.

G-U Hardware Expands Office

G-U Hardware has expanded their office and warehouse facilities. This is the second expansion in the last three years and doubles the space occupied three years ago. This expansion is attributed to the growing acceptance of their quality window and door hardware systems, the addition of their new line of multiple lock door systems, and their most recent successful introduction of their casement and awning window systems.

For more information contact G-U Hardware, 11761

Rock Landing Drive, Suite M6, Newport News, VA 23606-4235; Phone: (757) 873-1097; Fax: (757) 873-1298; E-mail: g-u@g-u.com; Web: www.g-u.com or circle 354 on Rapid Reply.

Wells Fargo Chooses ShatterGard

With only a 10-day notice, ShatterGard was able to install security window film on approximately 10,000 square feet of glass at the Wells Fargo Center in Los Angeles. The building is the largest in Southern California. The contract guaranteed the installation would be done in time for the Democratic National Convention. According to ShatterGard, the installation was done so that tenants and patrons would be protected from flying or broken glass due to civil disturbance, which might happen during the convention.

DORMA Architectural Hardware Promotion

Kim McDonnell has been promoted to group communications manager at DORMA Architectural Hardware. In her new role, McDonnell



will take on a managerial role for all group communications and will work to incorporate DORMA's brand identity throughout DORMA Architectural Hardware, DORMA Automatics, DORMA Glas, and Crane Revolving Doors. To accomplish these objectives, McDonnell will lead a team within the marketing group to handle graphic arts and communications. **TL**

The 1999 Jeep Grand Cherokee



by
Michael Hyde

1

The 1999 Jeep Cherokee has had a major re-design and I must say is looking good. The locks on this vehicle are made by Strattec and available from your Strattec distributor.



2

This vehicle is also equipped with a transponder system that requires a DART device for programming keys. The transponder key has a Grey colored bow on it and inside the bow is the transponder chip.



CAR OPENING



3 First start out with a good set of car opening wedges and a "under the window" tool. Sometimes referred to as a "caddy killer." The linkage rods on this vehicle are concealed in the weather-barrier, which is made of a thick rubber-like material. The rods travel in a sleeve portion of the rubber weather-barrier. You might be able to catch the linkage rods as they enter the rubber sleeve, but we found it easier to use an 'under the window' tool.



4 We moved the tool over the electric window button to unlock the Cherokee.

Ignition Lock

5

The ignition lock on this car is mounted on the column and uses an active retainer.



6

To service the lock you will need to remove the plastic two-piece shroud. Remove the single screw directly under the column.



IC Cores: Small Format

Everything you ever need to know about how to sell, service, install and troubleshoot interchangeable cores!



[CLICK HERE TO LEARN MORE](#)

#ICSF - 1



7

The rear shroud assembly does not need to be removed when working on this lock.



8

Underneath the column is the Sentry Key Transponder module. A portion of the module encircles the forward section of the ignition lock and is the induction coil (antenna) for the transponder system.



9

The active retainer is located on the bottom section of the lock housing.



10

To remove the ignition lock cylinder you will need to insert a working mechanical key and rotate until the retainer depresses and then the lock will slide out.



11

The ignition lock removed from the vehicle. The lock has a chrome face to it.



Flat Rate Manual

The National Locksmith.

Flat Rate Manual
For Locksmiths

Auto Lock • Car Opening • Key Cutting • Rekeying • Installation •
Domestic Auto • Car Keys • Duplication Keys • Masterkey Systems •
Commericals • High-Grade Locks • Insurance Auto • Locks •
Safe Work • Car Opening • Key Cutting • Rekeying • Installation •
Domestic Auto • Car Keys • Duplication Keys • Masterkey Systems •
Commericals • High-Grade Locks • Insurance Auto • Locks •
Safe Work • Car Opening • Key Cutting • Rekeying • Installation •
Domestic Auto • Car Keys • Duplication Keys • Masterkey Systems

Now you can easily "Price for Profit!"

CLICK HERE TO LEARN MORE



#FRM - 1



12 To disassemble the lock, rotate the lock counter-clockwise and depress the stop pin.



13 The cylinder plug removed. The lock plug uses eight tumblers and has a sidebar.

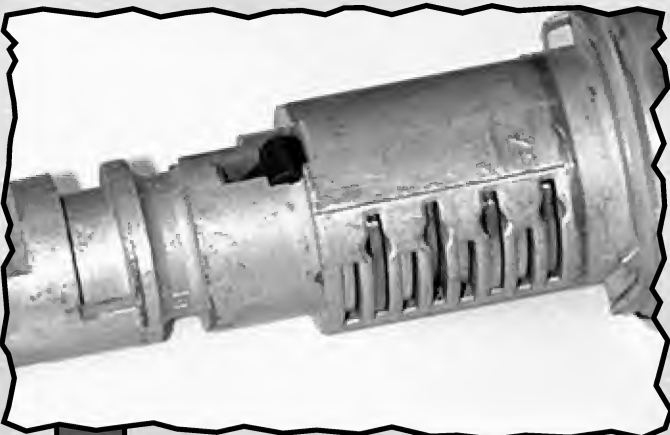

14 The cylinder plug uses a small actuator that must not be lost.



15 If the plug actuator is not in the plug when you re-assemble it, the anti-theft device located in the rear of the plug will not properly engage the security components in the steering column. The car will not start if there is no contact.

Programming Transponder Keys On Transponder Equipped Models When No Keys Or Only 1 Key Is Available

A tech device called the "DART" is needed for programming transponder keys when no keys are available. The DART unit is available from National Auto Lock Service at: (650) 757-0700.



16 There is a symbol on the instrument cluster that is an indicator for the 'Sentry Key' system.

GM Sidebar Lock Decoder System

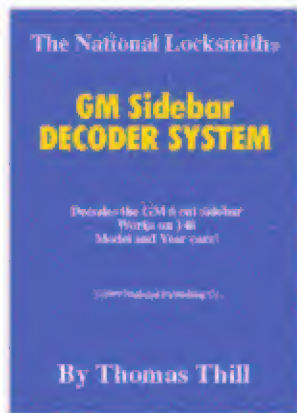

Tom Thill, the author of a new book, has invented an amazing new way to make keys for six cut GM Sidebar Locks.

[CLICK HERE TO LEARN MORE](#)

#TT - 1



Before you begin make sure car's battery is at least 12-volts. Don't guess, use a volt-meter on the battery terminals. You must also have the 4-digit PIN code for this vehicle.

17



The end of the connector cable goes into the car's computer diagnostic hook-up. This connector is standard on most vehicles in the United States. The main menu should automatically appear after the "Modem Check" screen runs its cycle. Use the down arrow to select number 4 for 'Skim Functions', press the Enter button. While the car's computer tries to communicate with the SKIM module, this screen will appear. To program a new transponder key you can just add a key or erase all keys. The DART unit requires that you enter the cars PIN. Enter the PIN and press Enter. The DART unit will now verify that you entered the correct number before it checks it with the number in the car's computer. If the pin is invalid you will get an error screen. If you enter the PIN wrong again the cars computer will shut down for 1 hour. If you correctly entered the PIN, the DART unit will prompt you to put in the new Chrysler transponder key and turn it to the RUN position. The DART unit confirms that everything went fine and the new key will work. You will get another opportunity to program in more keys. That's all there is, you're all done.

Programming Additional Keys When 2 Already Programmed Keys Are Present

1. You must have 2 already programmed Sentry Keys.
 2. Cut the new key(s) to the correct code or duplicate.
 3. Insert one of the 2 valid Sentry Keys into the ignition lock and turn to the RUN position.
 4. After the ignition has been in the RUN position for approximately 5 seconds, but not more than 15 seconds, turn the key to the off position.
 5. Remove the key and insert the second valid key and turn to the RUN position within 15 seconds.
 6. Approximately 10 seconds after the second key is turned to the RUN position, the Theft Alarm Light will start to flash, and a single chime tone will sound to indicate the system is in the "Customer Programming" mode.
 7. Within 60 seconds of entering the "Customer Programming" mode, turn the ignition switch to the off position, remove the key.
 8. Insert the new non-programmed key and turn the ignition lock to the RUN position.
 9. Approximately 10 seconds later, a single audible chime tone will sound and the Theft Alarm Light will stop, wait 5 seconds and then turn off the ignition.
 10. The system will immediately return to normal operation following the programming of the new key.
 11. To program an additional key into the system, you go through this process all over again.
- If you don't follow the above procedure precisely, you will have to start over. The above procedure will not work if 8 keys have already been programmed in.
- Next month we conclude this series with the door lock and trunk lock service procedures.

TNL on CD

CLICK HERE TO LEARN MORE

#TNL - CD1

A CODE SERIES: M001-M2618									
Bow	STANDARD SPACING							Tip	DEPTHS 1 .340 2 .315 3 .290 4 .265
1	2	3	4	5	6	7	8	Cut to Cut: .092	
.941	.849	.757	.665	.573	.481	.389	.297		
Bow	FRAMON SPACING							Tip	
1	2	3	4	5	6	7	8		
.310	.402	.494	.586	.678	.770	.862	.954		
Key Blanks:	ILCO: Y157, Y159			SILCA: CY22, CY24					
Reed Codes:	N/A			HPC 1200 CM		CX102			
Curtis Clipper:	Cam		Carriage		ITL MFG:		69		
	CHRY-5		CHRY-5A						
Pak-A-Punch	PAK-C5			M.A.C.S.:		2			

NOTES: FRAMON--- Lay tip stop clip flat against left side of vise, then tip stop key against clip. Set first cut at .310".
 Chrysler / Dodge / Plymouth / Jeep Transponder keys have a Grey plastic bow.

Transponder Key:
Strattec - 598495
JET - Y160-PHT

Quick Entry

UPDATE

by
Steve
Young



2000 DAEWOO NUBIRA

The name Daewoo may be new in the US marketplace, but the company has been in business for over thirty years. They started out in 1967 as a small textile exporter and slowly evolved into a leading multinational "General Trading Company." Today, the Daewoo family includes 197 different subsidiaries that manufacture and market over 3500 products in 165 countries. Their involvement in the automobile industry is such a small part of their business, that it only rates a small mention on their company web site.

Last month when I mentioned that Ford was negotiating the purchase of Daewoo, I was referring only to the Daewoo automotive branch and not the company as a whole. In addition, shortly after I submitted last month's article, Ford announced that it was breaking off negotiations with Daewoo. For now, the Daewoo automotive products will continue to be built in Korea and marketed in the US as an independent manufacturer.

Daewoo currently manufactures three vehicles that are sold in the USA. Last month I covered the Daewoo Lanos and the Daewoo Leganza, which are the least expensive and the most expensive models respectively. This month let's look at the mid-sized Daewoo Nubira. (See photograph 1.) This is a four-door sedan that is equipped with vertical inside lock control buttons on all four doors. This vehicle can be unlocked



1. 2000
Daewoo Nubira.

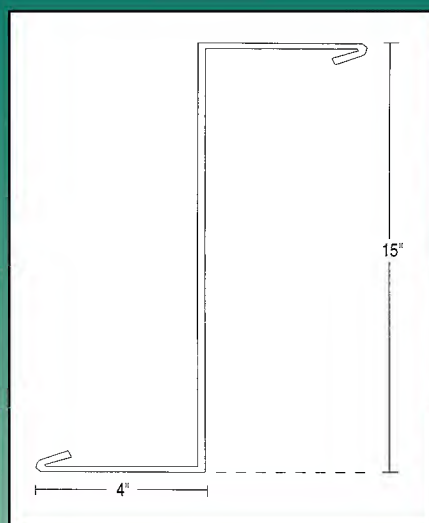

A. The TT-1017 tool.



2. The front door can be unlocked with the TT-1017 tool.



3. Pull upward and toward the front of the car to lift the inside lock button.

easily through either the front or the rear door. An inspection light is not needed for either method, but if you wish to use one, the linkage rods are easily visible inside the door.

The TT-1017 tool (see illustration A) can be used to unlock the Nubira through the front door. Begin by wedging open the weather-stripping at the base of the window about five inches forward of the inside lock button. (See photograph 2.) Carefully insert the tip of the TT-1017 tool into the door so that you can grasp the linkage rod from the outboard side of the door. When the hooked end of the tool has been lowered as deeply as possible, rotate the shaft of the tool so that the hook will be horizontal inside the door. While watching the inside lock button for movement, probe with the tip of the tool until you hook the vertical linkage rod. Pull the tool toward the front of the car to bind the linkage rod and then pull up on the tool to unlock the door. (See photograph 3.) Photograph 4, shows how the tool hooks the vertical linkage rod inside the door. Notice that the tool hooks onto the linkage rod at a point that is at the same depth as the outside door handle.

To unlock the rear door, use the TT-1001 tool. (See illustration B.) Begin by wedging open the weather-stripping at the base of the window just forward of the outside door handle. (See photograph 5.) Insert the hooked end of the tool into the door and lower until it is slightly deeper than the outside door handle. Next, rotate the tool so that the hook is pointed toward the inside of the car and then pull up on the tool to hook the lower horizontal linkage rod. Twist the top of the tool to bind the linkage rod and then lever the linkage rod forward to unlock the door. (See photograph 6.) Photograph 7, shows how the tool grips the linkage rod from inside the door. If you have trouble locating the linkage rod, watch the inside lock button for movement as you probe for the linkage. You can also use an inspection light to locate the linkage rod visually.



4. On the left, you can see the shaft of the tool as it is hooked onto the linkage. On the right, you can see the tip of the tool gripping the linkage rod.



5. To unlock the rear door, use the TT-1001 tool.



6. Twist the top of the tool in order to bind the linkage and then lever the linkage forward.

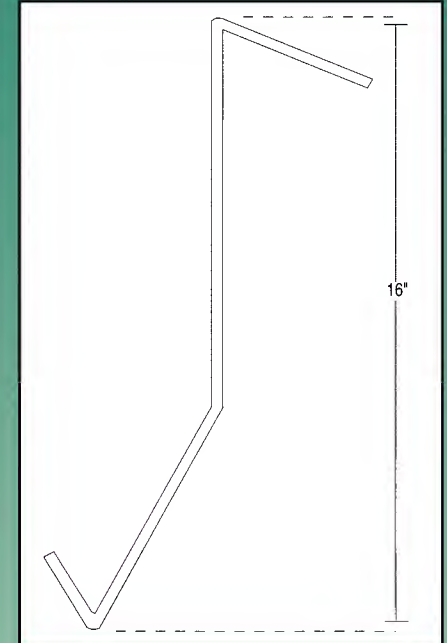

B. The TT-1001 tool.



7. Inside the door, the tip of the tool is hooked onto the lower of the two horizontal linkage rods.

Quick Reference Guide

<p>Vehicle: 2000 Daewoo Nubira</p> <p>Direction Of Turn: Clockwise (passenger side)</p> <p>Tool: TT-1017 (front door) TT-1001 (rear door)</p>	<p>Code Series: J0001-1200</p> <p>Key Blank: Silca DW04, OEM S6460029</p> <p>Bitting: Ignition, door and trunk 1-8, glove box 5-8</p>
--	--

The LIGHTER Side

'Tis That Season Again



by
Sara
Probasco

Have you noticed how everybody seems to get a little crazy, during the holiday season? December lends new meaning to the old phrase, "When push comes to shove." Sometimes I wonder where all those cars that fill every parking lot go at other times of the year. It's kind of like those bright orange road-construction cones. Rumor has it, somebody overbought those, several years back and could find no place large enough to store them, so they've been moving them around from one place to another, ever since.

We get some unusual lock-out calls, this time of year, too. Like last year, when a call came in just before midnight on Christmas Eve...

"My buddy and me, we're out here at U-Lock Storage, trying to get into our unit, and we can't find our key," the man said.

"At this hour?" Don asked, yanking all the covers off me as he rolled over in bed to squint at his super-size digital-print-out bedside clock. "Can't this wait until morning?"

"Well, we've got some Christmas stuff in there we want to get at tonight, if we could," the man insisted. "Besides," he added hesitantly, "our contract for the unit runs out tonight, and the owner's real hard-nosed about that. If we're not out by midnight, he might lock us out, and we don't want to lose our stuff."

"What's the deal?" Don asked, a bit suspicious. "Did you lose the key, or what?"

"Yeah," the guy said.

"Well, at this time of night, and on a holiday to boot, I'm going have to charge you sixty dollars to come out and get it open. Your best approach would be to wait until morning, or else cut the lock off with bolt cutters."

"It's one of those round kind of locks. You can't get at it with bolt cutters."

Little yellow flags went up in Don's

mind. He knew the owner of U-Lock Storage typically used Abus "doughnut" padlocks when locking out customers for non-payment of rent, so he didn't want to breach such a lock without checking. But it was Christmas! Besides, he hated to call the owner at that hour on Christmas Eve to verify the right of the renter to get into the unit.

"Tell you what: I'll come out and see what I can do," Don finally said, "but it's my policy to have the police meet me at the site, when I'm called out at this hour of the night, so give me a minute."

Don contacted the police department and had a patrol car dispatched to U-Lock Storage. When he arrived, the patrol car was already there and the officers were talking to the two men who had called for service. The police were telling them that the owner would not be apt to come down on Christmas day to lock them out of their unit, so guys decided to wait until the next day, after all. They said they would call Don when they were ready for him to come.

We never did know exactly what was coming down, that night. According to the owner, the rental contract did not expire that night, and the padlock wasn't his. The two guys never called us back to open it for them. Maybe they found the key - maybe they were trying to break into somebody else's unit and gave up on the idea. Maybe Don's caution kept somebody from getting stuff out of their own unit and put a real damper on their Christmas, or maybe he foiled the Grinch and made the day. I guess we'll never know.

"Did I tell you what Officer Smith said as they drove away?" Don asked me later.

"I don't guess you did."

"He said, 'Merry Christmas. Now y'all have a good night, y'hear..' Isn't that neat! Kinda reminded me of that new Texas version of 'The Night

Before Christmas' that's been going around."

"I don't guess I know that one," I said.

Don handed me a crumpled copy of the poem someone had given him, and I began to read.

A TEXAS CHRISTMAS
(author unknown)

'Twas the night before Christmas.
We were hoping for rain

When a blue Texas norther roared
over the plain.

The cold was a-whistling through
our loose windowpanes,

So Pa threw on a log to bring up
the flames.

I started a stew for our dinner next
day,

While the young'uns slept under
their blankets of hay.

Then Pa in his long johns and me
in my gown

Were a-warmin' our backsides 'fore
we laid ourselves down,

When we heard, from out on the
range, such a sound,

We looked out to see what was
stomping around.

Coming right for us, as sure as
your face,

Were eight scroungy longhorns
stampedin' the place.

They were pulling a wagon piled
sky-high with toys,

And the head honcho driving was
old Sandy Claws!

He was yanking the reins and a-
hollerin, "Woah!"

But they tore through the
clothesline and laid the gate low.

They shook loose their traces and,
as if seeing red,

Straight on, they trampled through
my flower bed.

Then they climbed up on top of our
roof with a snort

High Security Safes Volumes 1 & 2



These are the world's toughest safes! Contains many FULL PAGE photos! Learn to open High Security Safes now!



Volume 2 is packed with great information and photos of high security safes. Included are many opening tips designed to make your life easier.

[CLICK HERE TO LEARN MORE](#)



#HSS, HSS - 1

'Fore old Sandy was able to pull them up short.

We were gasping and choking from the dirt sifting down

When down the chimney Sandy came with a bound!

He was dressed all in rawhide with a Stetson, to boot,

And he carried a feed sack just brimming with loot.

He filled all our boots and piled them up high.

Then he looked out the window and up at the sky.

That cold Texas norther still whistled and blew,

But more young'uns were waitin' - his work wasn't through.

He gulped some "hot mud" and hunched close to the heat

To soak up the warmth and thaw his cold feet.

Then he left us and prodded the longhorns to go.

As the wagon took off through the fog and the snow,

We heard Sandy holler, "I'll see you next year.

Merry Christmas. Now, y'all have a good night, y'hear?"

Happy Holidays to you and yours!! Now, y'all have a good one, y'hear? **TNL**

Locksmith Dispatcher 2000



[CLICK HERE TO LEARN MORE](#)



#DIS - 2000

Corporate Safe Specialists



by Dale W. Libby, CMS

CSS stands for Corporate Safe Specialists. This company makes a varied line of safe containers used for day storage of money. They have both hopper and front-loading types along with other variations. Unfortunately, many customers use these units for other things than that what was originally intended by the safe manufacturer.

A common complaint by customers is the cryptic phrase "My safe will not work!" This mostly means that their safe will not open on the combination, but many other symptoms of safe abuse are also covered by this universal expression of consumer grief. A new restaurant was opening and this was the complaint. What the customer really meant is that their C.S.S. safe container would not lock.

There must be a large business that sells used safes to restaurants, without regard to what the restaurant really needs or wants. Too often price is the only denominator. The particular safe in question was a drop safe, front-loading, with a small upper door and a larger bottom square door allowing access to the deposits. The upper door is pictured in *photograph 1*.

The door features a nice "T" handle with an S&G (or ILCO) 4440 type safe deposit lock mounted Vertical Down. The slot in the outer ring can easily determine this. If the throat cut slot is facing down, it is facing the end of the bolt, and thus the lock is mounted VD. If the slot is to the left, or at the 9:00 o'clock position, the lock is mounted with the bolt to the left of the keyway, or HL (Horizontal Left).

Opening a 4440 lock is not difficult. If you do not have either key, then both the renter's and the guard "noses" must be pulled. When they are gone, just probe the lever tumblers out of the way and hook the bolt, and in this case pull up and the lock will open when the bolt is retracted into the case. A very easy quick opportunity to make easy money. The door was open and there were no keys.

Instead of making keys on the spot, I chose to install a new lock. I would make keys for the lock installed at a later time. Replacing the lock was cheaper and faster for me, and probably for the customer as well. If you look carefully at *photograph 1*, you can see that there are 1/8-inch holes drilled above each keyway. I do not know why these holes were drilled unless it was an aborted attempt to open the safe deposit lock.

When I removed the back cover to the door, I saw a real mess that had been caused by the previous person who worked on the safe door. There were grind marks and weld splatters all over the inside of the door next



1. Upper door of depository with double keyed 4440 safe deposit lock.



2. Inside view of previously repaired door. Note weld marks on bolt bar.



3. Bottom Door lock is mounted Vertical Down (VD).

to and under the lock. (See *photograph 2.*) The bolt bar was unnecessarily welded for a relock pin that was not present. There was no relocker when I worked on this unit, but evidence of its being there was apparent.

Someone really must have had a hard time with this safe door and punched the lock, which set off a relock trigger or device. They must have beaten the door open and destroyed the relock mechanism. The lock that was on there was new. After replacing the old lock and putting on the back cover, the upper door was done. Now I was ready to tackle the bottom one. (See *photograph 3.*)

I had the restaurant owner show me the problem because sometimes it is easier to let the customer show you what they are doing to get the safe door open, and you can determine the problems after seeing their opening procedures. He shut the door and the bolt handle worked fine. He spun the dial to the combination lock (which made me somewhat nervous, for he did not have the combination to the safe) and turned the handle and the door opened. Imagine my surprise.

After removing the inside cover it was easy to see and repair the problem. *Photograph 4*, shows the predicament. The bolt bar dropped below the end of the combination lock and was able to pass underneath the locked 3300 LaGard Lock. The bar was held in place with a "C" clip that had fallen off. I repaired the bar with a new clip and a back-up small snap ring and washer. Double protection.



4. The bolt slipped off stud on door, allowing bar to go under end of extended combination lock bolt.



5. Proper alignment of locking bar.

Photograph 5, shows the bolt bar in proper position, as yet un-repaired. I went completely through the lock to set a new combination. First I removed the spline key to remove the inside drive cam. I then removed the dial and tightened the dial ring screws. Alignment of the dial and lock was perfect. I tightened all the combination case screws (4) and set the wheels so the change key could be inserted. Not the easiest with the anti-fish plate installed, but doable anyway.

I then installed the back cover and set a new combination. I then installed the back cover with the relock plate. This pin is spring loaded. To deactivate, just drill beside the lock. I like to grab the spring and pull it out through the front. This takes all tension off the pin, and it can be easily pulled or pushed up to unblock the bolt bar.

So, the next time you get a complaint like "My Safe will not work!" be prepared for anything. Open, Repair, and Prosper.

TNL

Dave McOmie Safe Book Collection on CD

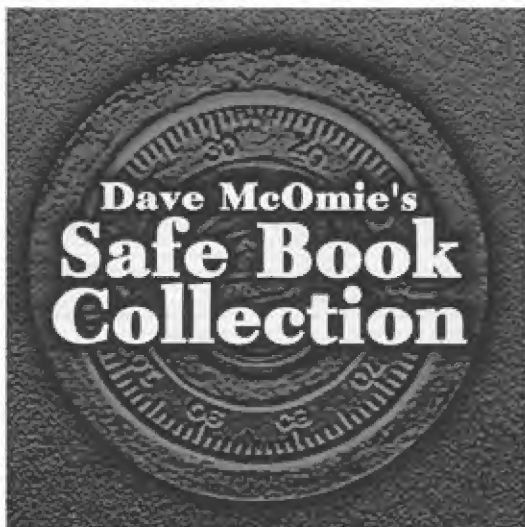

This CD contains every book Dave has ever published.

CLICK HERE TO LEARN MORE

#DMCD - 1



TECHNITIPS

Valuable prizes
awarded monthly
and yearly!



BWD KWIKIT WINNER: Clay Door Knob Fix

A customer brought in an old lock that he wanted repaired. The lock was a rim lock that was made before the 1900's. It originally had ceramic knobs on cast iron spindles, but the knobs were broken off. This customer wanted to use the lock on a cabin that he was building. I suggested that he buy a pair of brass knobs that a local hardware store had in stock, but he said the old lock would fit the decor of the cabin he was building and he wanted me to find a way to rebuild, or replace the original knobs. In other words, he wanted to restore the old lock to its original appearance. Other than the broken knobs the old lock was in excellent condition.

This was a real challenge and I decided to see what I could do.

After looking through a couple of craft catalogues, I found a substance called Super Sculpey. This stuff is like Playdough (but it hardens after being placed in the oven for a specified length of time. I molded the dough onto the shafts then 'cooked' it as the instructions said. With a little sanding after the handles cooled, they looked great.

When the customer picked the lock with the new knobs up, he was very pleased. The craft clay can be purchased from Sunshine Discount Crafts and you can find them on the web at: www.sunshinecrafts.com

*William Earl Knuckles
Kentucky*

Editor's Note: Earl, for future reference, Ultra Hardware, Pensauken, NJ carries (or they used to) a great line of ceramic and clay decorator knobs in a wide variety of finishes. 1-800-426-6379.



WEDGE CO KEY EXTRACTOR WINNER: Trapped Key Trick

I'm often called to remove a trapped key from Chrysler Motors vehicles. This problem is common to all the older pin tumbler ignitions that Chrysler made and is caused when the key is inserted upside down and is trapped by the key buzzer switch on the bottom of the ignition.

I have found that the easiest way for me to remove the key is to push the

buzzer switch down and out of the way, and slide the key out.

I do that by using a Weiser shim pick which is flat and narrow. I just insert the shim pick at the bottom of the keyway, slide it in depressing the buzzer switch and extract the key. The Weiser shim pick is ideal for this operation since it is thin enough to slide in between the buzzer switch and the key, and flexible enough to bend out of the way if you have to use an extractor to remove a broken key.

*William Cochran, CRL
Wisconsin*



STRATTEC WINNER: Homemade VATS Key Reader

Here's how to quickly, easily and inexpensively make a portable and accurate VATS key reader.

Obtain a regular spring-type wooden clothespin, two small wood screws, six

inches or so of 18-20 gauge wire, two small alligator clips and an Ohm meter.

Remove the spring from the clothespin and lay each "leg" out on the flat side. Now drill a small pilot hole in each "arc" or detent as show in *illustration A*. Place a screw in each hole and wrap a loop of wire (with the end stripped) around each screw and gently "snug" the screw to hold the wire in place, but do not drive the screw all the way through the wood. To ensure a good connection, use your soldering iron to put a bead of solder on each piece of wire and screw. Also, place a bead of

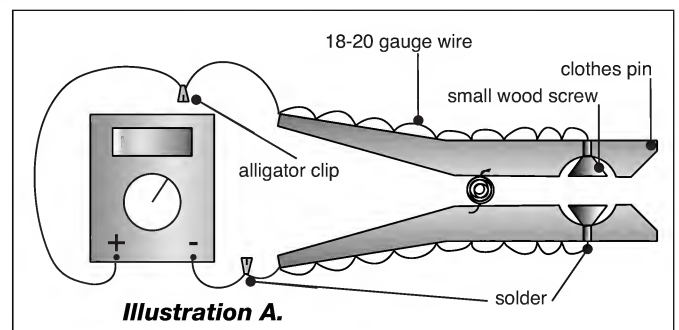

Illustration A.

A Few Words From Jake...

If we always use conventional methods to solve problems, we will, at best, produce only conventional results. If we use unconventional and innovative methods to solve problems, we just might produce spectacular solutions. At the very least, we might find an answer for a customer that no one else was able to provide

It is easy to say that a specific job cannot be done (conventionally speaking) and walk away from that particular task. However, it's far more profitable to find a unique, although unconventional, approach to the problem. So rather than say, "I can't do that", why not ask yourself: "How can I do that?" Many of us are often quick to tell ourselves that, "there's no way," when what we really mean is "I don't know how", or "I don't want to be bothered."

The Law of Multiple Redundancy says that there is a multitude of ways to solve a problem. Henry Ford did not invent the automobile or the assembly line, but he combined both ideas, added a little of his own "chutzpah" and put America on wheels. At the time, the thought of building a working man's car was about as unconventional as you could get. Thomas Edison did not invent the stock ticker, phonograph and light bulb by thinking conventionally either.

It's that convention that makes this column what it is today. Locksmiths who are faced with a problem often are forced to take an unconventional approach to solving that problem. Then they take the time to share their solutions with you.

Considering the "secrecy" that was so prevalent in this industry as little as twenty or so years ago, sharing information, ideas and tricks with your fellow locksmiths is really unconventional!

So, Keep them cards, letters and e-mails coming.

And, by the way... may you reap the best of whatever this season has to offer and may your New Year be a prosperous one.



*by Jake
Jakubowski*

solder on the top of each screw head and when it "sets", use a file to file a small groove into the bead of solder, making sure to "center" the grooves as closely as possible.

Now run the remaining wire down each leg of the clothespin as shown and either tape or hot glue it into place. Solder the alligator clips to the other ends of the wire.

Put the clothespin pack together (replace the spring) and you're ready to read VATS keys.

To "read" a key, place the key in the jaws of the clothespin and make sure that each side of the resistor pellet rests in one of the grooves you filed in the solder. Then attach the alligator clips to your digital multi-tester and you will get a reading of the key.

I figure that even if I had to buy everything I needed to make this VATS key reader, it wouldn't have cost me over \$30. As it was, I already had a meter and found everything else I needed around the house and shop.

I've included a VATS value chart for your convenience:

VATS KEY#:	RESISTANCE VALUE:
1	.402
2	.523
3	.681
4	.887
5	1.130
6	1.470
7	1.870
8	2.370
9	3.010
10	3.740
11	4.750
12	6040
13	7.500
14	9.530
15	11.801

*Rick LaTura
Massachusetts*



**HPC WINNER:
Stuck Top Pins**

Here's a quick fix for a stuck top pin. Remove the plug and other top pins from the housing. Then take a 1/16" or a 3/32" drill bit and drill a hole into the top of the chamber with the stuck pin. You can then drive out the culprit pin with a small punch or similar tool.

Next, clean the chamber of whatever caused the pin to get stuck in the first place. Finally, reload all the top pins and springs. Replace the plug as usual, with one exception: force a small master pin (.030 works fine) in the chamber with the hole before loading the top pin and

160 • Visit www.TheNationalLocksmith.com

spring to keep the spring from working its way up and out of the chamber.

I find this to be useful on a variety of key-in-knob cylinders, mortise cylinders, rim cylinders, and others where you can't remove the spring cover to gain access to the pin chambers. Of course, sometimes it is cost effective to simply replace the cylinder, but sometimes necessity warrants the extra effort.

*John E Hines
Texas*

Editor's Note: John, thanks for the tip. I have a concern about forcing a master pin into the hole left by the drill. If the pin seats solidly, you may not have any problems. However, if it does not seat properly you may have a call back just waiting to happen. I have found that when necessary, I can remove the retaining cap from mortise and knob cylinders with a piece of hacksaw blade and a hammer. (Juanita Ramsey sent this tip in years ago.) Just place the blade on the retainer - tooth side down - and gently tap until the retainer slides out of its slot. To replace, lay the retainer topside down on your work bench and place the hacksaw blade in the center of the retainer and gently tap with a hammer until the retainer is "V" shaped. Replace over the chambers and use a piece of steel or aluminum that's slightly narrower than the retainer and tap the retainer in place. It will work its way back under the swages that held it originally.



**SARGENT &
GREENLEAF WINNER:**

A DIY homeowner tried to install a peep-hole in a metal door but used too large of a drill. The peep-hole pushed right through the door. My solution to the problem was to purchase a package of two solid brass 1-1/2" diameter knob back plates. These are commonly used on kitchen cabinets. Using the existing as a pilot hole I drilled a 1/2" hole through the back plate. I mounted the peep-hole with a back plate on the inside of the door. The polished brass scar plate looked as if it should be a part of every peep-hole.

*Frank Ortiz
E-mail*

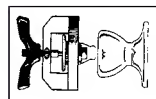

**A-1 SECURITY
PRODUCTS WINNER:
Hinge Security Stud**

After rekeying several locks for a new home owner, he asked me if the hinges on his doors were "burglar proof." When I told him no, he wanted me to fix them so they are.

I didn't have any Hinge Security Studs on my truck and knew it would be at least three days before I could get

some. I also knew it would involve a return trip with no trip charge, so I began rummaging around in my truck to see what I could come up with.

I found a handful of 8-penny nails in a bag and thought that I could substitute them for the screw in Hinge Security Studs.

On each door, I removed two screws from each leaf of each hinge. Next, after drilling a pilot hole to keep from splitting the wood I drove a nail in the hole where the screw had been on the door leaf.

Then, I drilled a 1/4" in the hole where I had removed the screw from the jamb leaf of the hinge, deep enough (about 1/2") to accept the new "stud". Finally, I cut the exposed end of the nail off to within about 1/2" long, or until it cleared the edge of the jamb-side hole as the door closed. This varies from door to door. Some are 3/4" depending on the "play" in the frame.

My studs weren't "factory" but they did work and allowed me to complete the job without a return trip. Of course, I charged accordingly.

*Danny Corner
Pennsylvania*

Editor's Note: Danny, thanks for the tip. Here's another idea for you. Keep a small supply of roll pins in a plastic box. Next time you run across a door like this, open the door and drill the appropriate sized hole through one of the "knuckles" of the hinge and into the hinge pin. Insert a roll pin, file or cut off the excess and the hinge pin is secure.



**ILCO KEY BLANKS
WINNER:
I-Core Removal Trick**

I have several accounts where supervisors change the cores in their interchangeable core system. One supervisor called me because he could not get the control key to remove the core when he was trying to change the locks.

I have found this problem to be caused by corrosion, Super glue, bent keys and popped retainer caps.

When I got to the site, I tried the core removal key and found it wouldn't work. Next I tried the change key for the lock and it did work. I assumed it was either corrosion or a popped retainer that was responsible.

Lubricating the core didn't help, but then I inserted the core removal key and began gently tapping on the face of the core with a plastic hammer while trying to turn the key. The lubrication and tapping jogged the control pin into position and the key turned. When I

pulled the core out, a retainer cap had dislodged over one chamber

Frank Sutler
E-mail



**KEEDEKX WINNER:
Handcuff Removal Trick**

The local police department called me to remove a pair of handcuffs from a prisoner's wrists after they had broken two keys in the locks. The prisoner was not cooperative while the officers were trying to get the cuffs off. Not only did they break the keys in the scuffle, the cuffs were tightened to a point where they almost cut off the guy's circulation.

I tried removing the broken keys, but the guy would not stay still long enough. I was getting a little frustrated myself when I remembered a tip in a long ago column about using a "pinch pick" (bolt cutters) on a padlock.

I went out to my truck, got my bolt cutters and came back to where the prisoner was. I told him that he was going to have to hold very still because if I slipped with the cutters, I might hurt him. He became very docile as I slipped the cutters over the flat, adjustable shackle of one cuff. With a quick snap, the shackle shattered. I repeated the process on the other cuff and the prisoner was out of the handcuffs, no worse for the wear.

I reasoned that since the shackle was hardened steel, it would probably break just like a padlock shackle. It worked and I opened my first pair of handcuffs.

James White
E-mail



**TECH TRAIN TRAINING
VIDEO WINNER:**

When the Weather Outside is Frightful

This tip is for cold weather locksmiths with the capability to run electrical equipment from their service vehicle.

When called to service an automobile with a frozen latch, I use a 150-watt Halogen light to thaw the latch unit. I place the light about 1-inch away from the door at the approximate height of the latch and turn on the light.

The heat generated from the light heats the area enough to thaw the latch. When it is really cold, I cover the light and door panel with a towel to keep the heat in. Just make sure the bulb does not come into contact with the painted finish or any rubber. It usually takes about 10 to 20 minutes to thaw a frozen latch, while I'm sitting in a nice, warm, truck.

Jim Wallner
Wisconsin



**SIEVEKING PRODUCTS
GM E-Z WHEEL PULLER
WINNER:
Inspection Light Trick**

PRO-LOK makes an outstanding inspection light (Part #AL3000), that uses a 9.6V Makita Battery, with a 6V Halogen bulb. When mine died, I came up with a super bright repair.

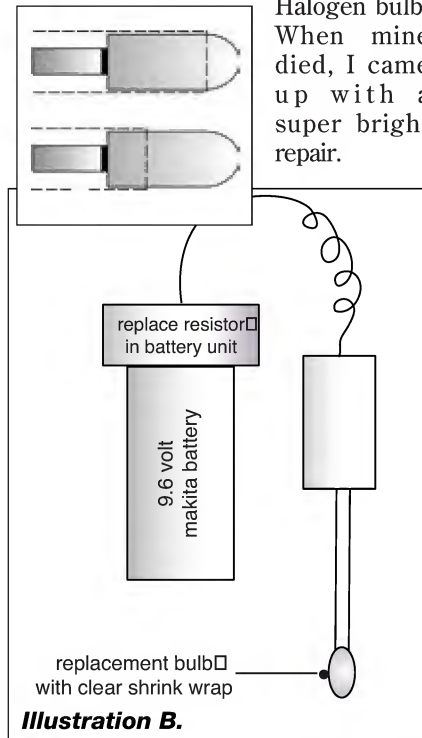

Illustration B.

I bought a 10 Watt, 2.70HM, Flameproof resistor, a piece of high-temp (275(F) 3/8" shrink tube, and a 6V Halogen replacement bulb for MAG's rechargeable flashlights (Part # LR00001).

First I removed the screws on the top of the battery holder and removed the cover. Leaving enough wire as possible, I cut out the old resistor. Next I soldered in the new flameproof resistor and then installed the new bulb. (See illustration B.) I then covered the end of the bulb and wire with the heat shrink tubing. The shrink tube also helps protect the bulb from damage.

If you place the shrink tubing farther towards the head of the bulb, the light is directed forward. If you pull the shrink tube farther back on the bulb the light is less focused but will make daylight out of the inside of a door panel.

Leonard Downing, CPL
Oregon

Major MAJOR
MANUFACTURING, INC. MANUFACTURING
PRODUCTS WINNER:
Keedex Van Opening Trick

I don't do car openings as a rule and when a call came in for one, my first instinct was to turn it down. However, I thought, "Why not?" and went out to

NSO One Year Membership

To make big profits in safe work with no hassles...you need information!

Free when you join NSO

CLICK HERE TO LEARN MORE

TheNationalLocksmith.com

Technical forums, chat, online store, plus
visit our sponsors...

WEB REVIEW

Herbert L. Flake Company

<http://www.hlflake.com>



Here is a nice distributor web site. We think that it is a good example of how the internet can be properly used for wholesaling of products. You can apply for your account and credit right online. Doing so gives you a user name and password to place online orders, and qualify for internet discounts.

In fact a standard discount applies to all orders placed over the internet. Up to \$600 nets you a 1% discount, up to \$1000 gives you 2% off, and over \$1000 saves you 3%.

The inventory is deep. For example, over 1,100 tool are on display. The online catalog is updated daily. You will find that to receive full access will take a few minutes of your time. But it is well worth the effort to gain complete use of the catalog and even the site's Quote Generator.



1-800-UNLOCKS



www.1-800-UNLOCKS.com

A&B Safe Corporation



www.a-bsafecorp.com

Abloy® DiskLock Pro



info@abloy.ca

Adesco Safe Manufacturing Co.



www.adesco.com

Aiphone



www.aiphone.com

Dynalock Corp.



www.dynalock.com

Framon Manufacturing Co.



www.framon.com

HPC, Inc.

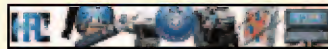

www.hpcworld.com

International Locking Devices, Ltd.



www.gatelock.com

KSP

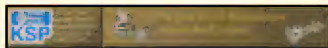

www.iccore.com

KustomKey



www.kustomkey.com

MAG Security



www.magsecurity.com

Major Manufacturing



www.majormfg.com

Maziuk Wholesale Distributors



www.mzkworld.com

McDonald DASH Locksmith Supply

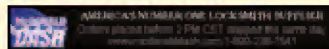

www.mcdonddash.com

Meilink

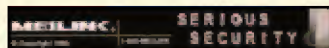

www.meilinksafe.com

Monaco Lock



www.monacolock.com

National Auto Lock Service, Inc.



www.laserkey.com

Omaha Wholesale Hardware



www.omahawh.com

ROFU International Corp.

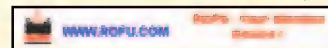

www.rofu.com

SecuraKey



www.securakey.com

Security Resources, Inc.



www.techtrainproductions.com

ShatterGard Security Window Film

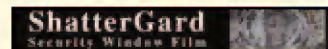

www.shattergard.com

Sieveling Products Co.



www.sievelingprodco.com

Tanner Bolt and Nut

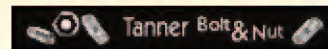

www.tannerbolt.com

TekTone



www.tektone.net

Manufacturers and distributors... join the high profile locksmith web site and you'll be featured here!
Call Jeff Adair (ext. 15) or Debbie Schertzing (ext. 16) for details. (630) 837-2044

open the 1996 Ford Van (no vent windows). The opening manual I had called for a certain tool and detailed how to unlock the door by getting under the linkage and lifting the button. It just didn't work for me.

Looking for alternatives, I went to the side window only to be told by the customer that they were bolted shut and the latch on that door was broken. Next I went to the rear door, which had the same window configuration. I tried removing the license plate screws and the tag light, etc. All to no avail.

I had a couple of pretty sturdy wedges and decided to try to wedge the door open and get something in the opening and pull the locking button up. Not one tool I had in my opening set would do the trick and there wasn't a coat hanger in sight!

As I was rummaging around in my truck for something to capture the lock button with, my eye fell on my Keedex K-22 Lever Opening Tool.

The end of the tool that goes over the lever (with the cable attached) has a radius bent in the end where the cable is secured. I inserted this end in the opening between the doors and lowered it until it was close to the lock button.

Using the cable, I maneuvered the radius over the lock button and pushed the tool downward. After releasing the pressure on the cable, and lifting on the tool, the tool bound on the lock and lifted it to the unlock position and I was able to open the door.

*Pete Gamble
North Carolina*



**SLIDELOCK'S "Z" TOOL
OPENING SET WINNER:
Car Opening Tip**

Ever have a vehicle where the door window was so tight that you couldn't get your tools inside the window? I ran into that and found a simple solution.

First, I use a mixture of window washer solvent and dish washing liquid of about 10 to 1 mix (10 parts solvent to 1 part dish fluid) on all contact points that are getting stuck to help it through. Then I use a 5-inch suction type dent puller.

Insert the tool that you need into the door cavity and line it up on the to the spot that gets tight, then pull the suction dent puller out to help loosen the window and push the puller onto the window where the bind is.

Just apply a little pulling pressure to pull the glass back and your tool should

go right past the bind. You can also use this puller on frameless windows to help wedge the window without damaging the seal by pulling the window back enough to simply place a wedge in the gap.

*Frank Kitchen
E-mail*



**THE SIEVEKING AUTO
KEY GUIDE WINNER:
Latch Protector
Solution**

I was asked to install a latch guard on a sliding, narrow stile glass door. The door had an Adams-Rite hook bolt on it that locked into the jamb and was connected to a vertical bolt that locked into the top rail of the jamb. Both bolts locked or unlocked with one turn of the key.

The header bolt was attached to a threaded rod, which was concealed inside the stile of the door, and the rod screwed into a connector that was attached to the hook bolt by a roll pin.

The problem I encountered was caused by one of the latch guard bolts (the top one) which prevented the lock from working when the key was turned, because the threaded rod was binding against the through bolt that attached the latch guard.

I could not use a latch guard with a drive pin at the top because this particular chain of stores wanted all their storefronts to look the same. Even down to the latch guards used.

I solved my problem by removing the entire locking assembly and bending the connector as shown in illustration C. This allowed the connector to bypass the mounting bolt without binding the

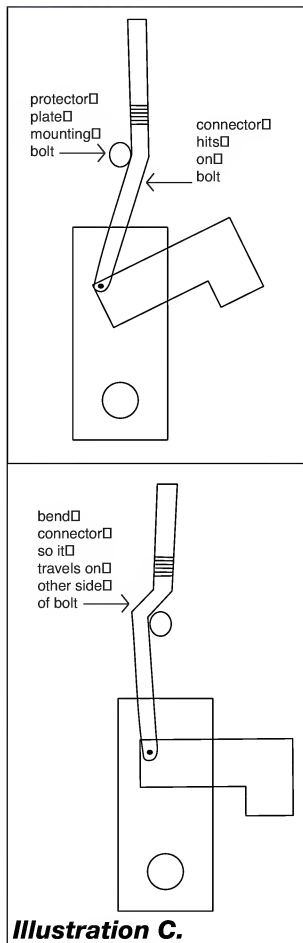

Illustration C.

mechanism and the fix worked great.

*Mike Spencer
Canada*



**JET KEY BLANKS
WINNER:
Recycled Repin**

I was in a hurry to leave the shop and walked out without putting my pinning kit on the truck. One hour and forty miles later, I had the locks off the customer's door and on my workbench when I discovered I didn't have my pinning kit.

I decoded the customer's key (35873) cut new keys to 37835 and just rearranged the pins in each of the existing cylinders. The old keys wouldn't work and each cylinder worked fine.

William Harrison



**HIGH TECH
TOOLS WINNER:
GM Sidebar**

Trick

I have had trouble picking the sidebar on GM 10-cut ignitions in the past. I found the easiest way to pick the side bar is to put a blank key into keyway and with moderate pressure on the sidebar, use a piece of spring steel and slide the key blank slowly out of the cylinder. It depresses the side bar on the first or second try.

*Dennis
E-mail*

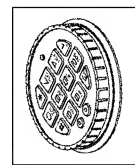

**LAGARD WINNER:
Topsy, Turvy Safe**

I was called to open a small locked safe and when I arrived, the combination lock worked fine. When I turned the handle, it didn't feel like the relock device had activated since the handle turned all the way to the open position. I decided to see if maybe one of the bolts was hung up or came loose from the carry bar.

I flipped the safe on its side and tried to retract the bolts with no luck. Then I flipped it on its top, turned the handle and retracted the bolts. The bottom bolt had come loose and prevented me from opening the door.

I turned the safe right side up and reattached the bolt to the carry bar and the bolts retracted properly. The best part was, I didn't have to drill and repair any holes.

This will obviously only work if the unit is not secured to the floor.

*Bill Weingard
Arizona*

