

December 1988

# The National Locksmith<sup>®</sup>

1989

LOCKSMITH

DIRECTORY

**Inside This Issue:**

Commentary • Industry • Directory Listings  
Year End Index • Technitips • Shop Talk



# Contents

## Features

### 28 Manufacturers

Our Locksmith Directory begins with the manufacturer listings section. Included is all the important information you need on each company.

### 72 Distributors

This section contains listings of the distributors and wholesalers serving the locksmith industry. Information is provided on each distributor.

### 94 Schools

There are a number of organizations to provide education to locksmiths. Here is a section giving data on the institutions in our industry.

### 94 Miscellaneous

Several companies do not fall into one specific category. Therefore, they are listed here with full company descriptions.

### 98 Year End Index

Here is a detailed index showing articles that have been printed during 1988 in *The National Locksmith*. Use it when you need to locate information.

### 103 The BiLock From Australia

Jack Roberts goes down under for this report on a locking system that hails originally from Australia. And no, it's not a kangaroo lock.

### 120 A Car Opening Trick

Do you mean to tell us that Dale Libby can open cars too? We thought he was only in love with square metal boxes! Here's Dale's Tale.

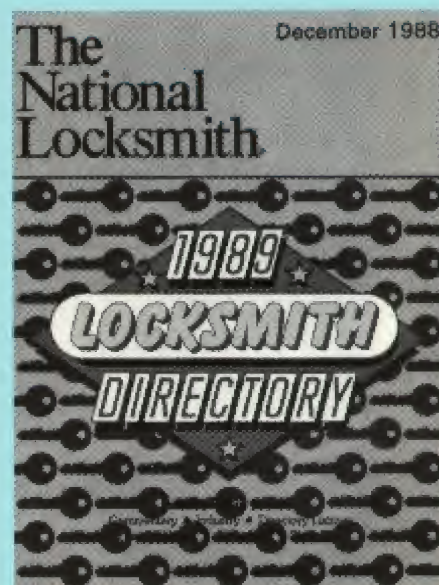

#### On The Cover

This month's issue brings you a comprehensive guide to the companies in the locksmith industry. Also, our Year End Index will serve as a guide through the back issues of 1988. This is certainly an issue you will want to save for reference all during 1989. (Cover art by Dan Sharp.)



## Departments

5 Commentary 6 Letters 9 Technitips 22 Newsmakers 126 Shop Talk

**Editor/Publisher** Marc Goldberg  
**Managing Editor** Sandy Kucharski  
**Editorial Assistant** Debbie Schertzing  
**Circulation Manager** Barbara Coulam  
**Production Consultant** Marian Raney  
**Technical Editor** Robert Sieveking  
**Technical Writers** E. Lee Griggs, Ed Hill, Dale Libby, Joseph Locke, Regis McCafferty, Dave McOmie, Rick Ohmit, Don O'Shall, Jack Roberts, Shirl Schamp, Steve Spiwak  
**Advertising Sales** Thomas Mlodoch  
**Technical Advisors** Richard Bushe, Robert Robinson, Sean DeForrest, Bert Michaels



### The National Publishing Company

The National Locksmith® ISSN #0364-3719 is published monthly by the National Publishing Company, 698 Bonded Pkwy., Streamwood, IL 60107. Phone: 312-837-2044. FAX: 312-837-1210. Second class postage paid at Bartlett, IL 60107 and additional mailing offices USPS 040110. Subscriptions \$28.00 per year in the USA; \$32.00 per year in Canada; \$37.00 in all other countries. Single copies \$4.00 each. Postmaster, please send change of address to National Publishing Co., 698 Bonded Parkway, Streamwood, IL 60107.

©1988 by The National Publishing Company. All rights Reserved.

Printed in the U.S.A.



---

# Commentary

---

## Locksmiths Elect A President

---

Well, by now the results of the election are in and you all know who will be the next President of the United States. But as I write this *Commentary*, I do not know who that man will be. The deadline for writing this article falls right before election day. However, the results of our Locksmith Survey have been received! If locksmiths vote like the rest of the nation, then the election will be won by one candidate by a landslide.

According to locksmiths, the next President will be George Bush. Bush won our Locksmith Election by an overwhelming majority. He received the support of 80% of the locksmiths who voted. Dukakis received votes from only 20% of you who cast your ballots. It is interesting to note that of the few locksmiths from Massachusetts who voted, none of them voted for Dukakis.

I guess this means that locksmiths are conservative people, more ready to support a Republican than a Democrat. However, I think that many people vote with their pocketbooks. The economy has been strong and unemployment has been low. Because of this, lots of folks are reluctant to make any big changes in government. Perhaps they feel that Bush is likely to continue the prosperity which the Reagan years have brought us.

To be honest with you, I have believed all along that Bush would win. I will be very surprised if he does not. My thinking is that people vividly recall the inflation and interest rates under Carter. They are afraid that another Democratic administration would drag us back to those days. I am not saying that this is an accurate assessment of the situation. However, I think that this is what is on many people minds as they cast their votes.

Whether we now have a President Bush or a President Dukakis, the man will be facing some dramatic problems. The deficit and the balance of trade are only two of them. It is quite clear that something is going to have to be done about these issues. If not, our children will be living in a world with a much weaker America than we now enjoy. Let's look to the future and hope our new President does his job well.

\*\*\*\*\*

The September issue of *The National Locksmith* carried an unsigned article entitled *Opening Simplex Locks*. Regretfully, the article, clearly one that was written at least 20 years ago, does not reflect the product as manufactured today. The article has not taken into consideration the many improvements which have occurred in the design and manufacture of Simplex chambers presently used in Simplex and Unican locks. Evidently, the author stresses a sense of touch or feel which cannot be duplicated in the present product.

*The National Locksmith* regrets any inconvenience we may have caused the industry. We withdraw the article in its entirety and recommend that should locksmiths wish to service Simplex and/or Unican locks, the Simplex Marketing Group provides eight hour technical clinics to bona fide locksmiths through local associations, wholesale suppliers and ALOA.

\*\*\*\*\*

I would like to wish each of you a happy, safe and peaceful holiday season. Remember, drinking and driving don't mix. See you next year!



*Marc Goldberg*  
Editor/Publisher

November 5

# Letters

Comments, Suggestions and Criticisms

*The National Locksmith is interested in your view. We do reserve the right to edit for clarity and lengths. Please address your comments, praise, or criticism to: Editor, The National Locksmith, 698 Bonded Parkway, Streamwood, IL 60107. All letters to the editor must be signed.*

## Reader Applauds Libby's Return

Many kudos, congrats, and kowtows to *The National Locksmith* for giving the ink from Dale Libby's pen a place to dry again.

Dale's technical expertise, sense of humor and nuts and bolts literary style were greatly missed by myself; and I'm sure many other professional locksmiths and safesmiths.

Dale Libby is one of the true guru's of safesmithing.

Dave Lindstrom  
California

## Locksmith Objects To Contractor's License

California locksmiths may be as surprised as I was to learn that if a locksmith does any rekeying work totaling more than \$300, he is required to have a Contractor's License. While it makes no sense to me that repinning locks is considered a structural change

to a building, the Contractors Board considers it such.

The board demands all locksmiths to be contractors and anyone who refuses to comply will be forbidden to advertise in the Yellow Pages. The exception however, is that the locksmith must state "not a licensed contractor" in the ad, on cards, billboards, vans, etc. Since 98% of my business is under \$300, I am not getting a contractor's license and will turn down the 2% over \$300.

Steve Brairton  
California

*Editor's Note: No locksmith in California should be surprised by this law. It has been in effect for quite some time.*

## Safety Concern Expressed Against Police/Fire Opening

Enclosed you will find a clipping out of the Arizona Republic, telling how we went before the Mesa City Council on Oct. 3, 1988 because we had had enough of the city fire and police opening autos with their courtesy vans. We were trying to prevent a tragedy from occurring.

As all of us in the profession know, the linkage can become disconnected and people can become trapped in the auto and die as in the case of an accident in Phoenix. We were told by the City Council that we needed more doc-

umentation from articles written in our profession's journals and documentation from other towns and states showing that this problem has occurred and that there is an ever present danger of someone becoming hurt or trapped.

Would you please help us? We are very concerned that no one is killed because of this city's policy. We have also learned that the city is repairing locks out of one of their fire stations. Any stories, legislation, or documentation with the credentials of the person who wrote the story would help.

We will be presenting this to the City Council and the Republic and Mesa Tribune. The Council treated this problem like it was a big joke. We are hoping that a few locksmiths can make a difference and save some lives.

Susan Fields  
Arizona

## Letter To Police Gets Action

*The following is a letter sent by Gilbert Fletcher to the Stratford, Ontario police chief regarding police officers doing the work of locksmiths. Following this letter is the reply he received from the Stratford Police Force.*

I am a local locksmith and have serviced this area faithfully for ten years. It has come to my attention that on several occasions police officers have

*Continued on page 132*



## ASP - Your Auto Service Center for the World

[Click here for more information](#)



# Technitips

Helpful Hints from Fellow Locksmiths



Send me your Technitips. Who knows, you may be our next winner! c/o The National Locksmith, 698 Bonded Parkway, Streamwood, IL 60107.

by Robert Sieveking

*Congratulations to this month's Technitips winners. There were a number of very good original ideas submitted this month. The challenge goes on. Who will carry off the top prizes this year? Who will step forward, to accept the applause of the industry, for their knowledge of the craft or craftiness in solving a common problem in the field of locksmithing?*

*I received a short note from one of the masters of the trade this month. Sal Schillizi, of safe manipulation fame,*

*has had his manipulation record included in the Guinness Book Of World Records. This for having held the title of World's Fastest Safe Cracker for 22 years, with a best time of 9 minutes 40 seconds. Skip Eckert was also named for his unbelievable record of 3 minutes 59 seconds in the 1988 contest, held at the ALOA convention in Las Vegas. Most people take longer than that to open a safe with the combination. Congratulations gentlemen.*

*Though speed in completing a particular job is important, the quality of your work is equally important. As I hear from the artists of the drill and torch set, I can't but think that somehow there has to be a better way. Then, after sitting in front of a safe for a couple of hours with no results, my attitude swings from the patient confidence of a manipulator to the frus-*

*trated desire for quick results and a burning desire to do permanent damage to the safe. How an iron box can take on a personality, I can't explain. But the feeling of having defeated a lock by manipulation is by far one of the most satisfying feelings I know. I strongly encourage anyone with the desire to learn manipulation, to study and give it a real try. Like the Rubik's cube or puzzles of that sort, manipulation is a kind of skill that can become addictive. I like to consider it as one of the marks of a master craftsman.*

*As you read this, the Technitips of the past year are being judged and sorted. Next month is the big month for the winners. The winners will be announced and there'll be some pretty nice prizes shipped around the country.*

*This has been a fantastic year for me, and I sincerely hope that the past year*

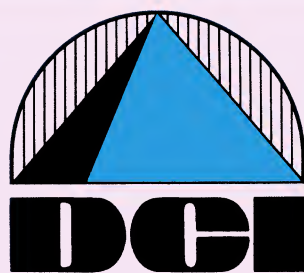

***We have it all.  
Quality, Value,  
& Service.***

[Click here for more information](#)



has brought you good fortune also. To all those that contributed to Technitips this past year, **thank you**. It is only by your participation that this column can serve us all. I've learned some new tricks, and hope that you too have discovered some new ideas that you found useful. A new Technitips' contest, with new prizes and challenges will be announced in January.

Happy Holidays and may the New Year bring you new challenge, reward, and satisfaction from your labors.

Bob Sievcking

### December's Best Tip

O.K., your appeal has finally motivated me to turn in this Technitip. It may not be typewritten, but at least I didn't write it on a cigarette pack! Actually I started to write it on a cigarette pack, but I ran out of room.

This tip has made safe opening as easy as A-B-C, and it can make it that easy for you too.

After pulling the dial and dial ring and drilling for either a scope read-

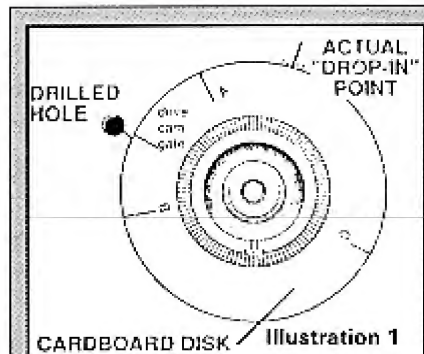

ing or a direct read, the challenge becomes to transfer the gates to the proper drop-in to open the safe. To accomplish this, I make a pencil mark at the drilled hole. This index will become the hole index. I then cut a round piece of cardboard and punch a hole in the center that will fit snugly and securely over the spindle shaft. The diameter of the disk is just large enough to reach the edge of the drilled hole. If you have trouble holding the disk to the spindle shaft, you can tape it to the back of an emergency dial or knob that is attached to the spindle stub.

The next step is to dial the lock, using the proper dialing sequence to line up each gate at the site of the hole. As the first gate is aligned, mark the disk with an "A" and a small mark that aligns with the "hole index." Then dial to the second gate, and mark the disk with a second mark and label this mark "B". If the lock is a three wheel lock, dial to the last gate and mark the disk "C" to show the location of the last gate. (See illustration 1.)

If the location of the drop-in is not known, dial to the gate in the drive cam and mark the disk with the location of the "drive cam gate." You now have the combination as A-B-C. Turn the dial slowly in the appropriate direction, to the drop-in. You should be able to feel and hear the fence, as it drops into the gate of the drive cam. Using the mark on the disk, place a mark on the face of the safe that will show the location of the drop-in.

When working on a lock of a known manufacturer, where the mounting direction of the lock is known or the exact location of the drop is known, it is not necessary to locate and label the drive cam gate or transfer its location to the drop-in. Simply mark the location of the drop-in index at the proper position on the face of the safe.



**The Innovation You  
Expect, with the  
Flexibility You Need!**

[Click here for more information](#)



After marking your dial, dial your A-B-C combination to the hole index one time to check that your turns were correct and your sight reading was straight in and not at an angle. All that remains is to dial your A-B-C combination to the drop-in index. It may be necessary to oscillate the dial at the drop-in, but the safe should open at this point. If the safe fails to open, simply place a second opening index mark (drop-in) on the safe either to the right or to the left of the first drop-in or opening index; then oscillate the dial at the drop-in. This should allow the safe to be opened. If not, mark another index and try again. Continue until the safe is opened.

This method eliminates all the math required with adding and subtracting numbers from the sight read combination, to transfer the gates around the dial to the drop-in. This is the simplified Cochran A-B-C transfer method.

Bill Cochran  
Wisconsin

\*\*\*\*\*

This Technitip is for an easy-to-make and inexpensive method of holding lock shims. Small pieces of curved shim stock are easier to manipulate and less likely to cut your fingers when they are held in a holder or handle of some type.

To make this shim holder, you will need two key blanks with a center groove, such as the Schlage SC-6 (Ileo 1037A) and a rubber band. Photograph two shows the assembled shim

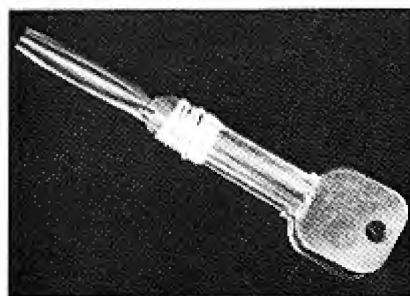

2. Assembled shim holder.

holder. The top key head is bent upwards t about a 15 degree angle. Wrap the rubber band several times near the tip of the blanks to give enough tension to hold the shim securely. Squeeze the heads of the keys together to open the tip of the holder and insert the shim.

When you're not using the shim holder, hang it on your key board. It

won't get lost and the shims won't get damaged lying on your bench.

Andrew Nogaj  
Japan

\*\*\*\*\*

This Technitip concerns the Armor 8" square door safe. The safe head is used as a floor type and hinged door safe. The drill point for this safe is directly under the tip of the "T" handle. The handle can be turned aside enough to allow the drill to enter. In some cases, (earlier models I think) this technique will also dodge the hardplate.

I have found that sometimes the

hardplate does not extend far enough to protect the bolt retractor bar. By drilling the head at this point, you will be able to drill off or drill and punch off the portion of the bolt retractor bar that engages the lock bolt. This will allow the handle to turn and the safe to be opened very easily.

Illustration three shows the back of the safe head with the cover removed. The handle is shown for a size comparison. Be careful, if you punch the retractor bar too hard, you will blow the lock bolt and break the lock cover off the case, requiring replacement of the lock.

**HPC, Inc.**  
**Designing Excellence and  
Manufacturing Quality  
since 1956**

[Click here for more information](#)



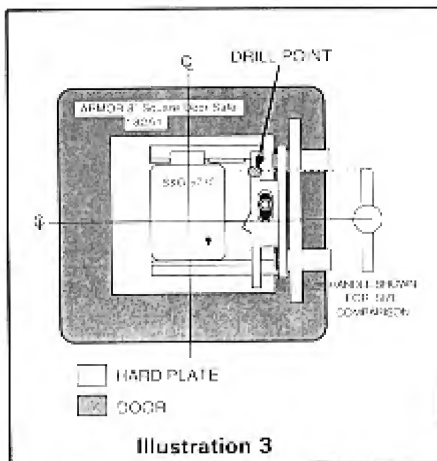

If done properly, this method saves the lock and only requires welding the door and bolt retractor bar.

Raymond Hayes  
New York

\*\*\*\*\*

This Technitip concerns the modification of a pinning kit to increase your speed when working on specific (i.e., not generic) lock cylinders.

What I have done is purchase colored 1/4" self stick dots from an office supply store. They are sold to code office files.

Using the green dots, (I use green for Arrow Lock) put a dot next to the pin compartment for the correct pin length for each depth from "0" to "9." In the center of each dot, write the manufacturer's depth for that pin (i.e., 0, 1, 2, etc.). Consult the reference chart in the lid of the pin kit for the correct pins for the manufacturers you use most. You will find it a lot easier to look at the dots than always looking up to the cross reference chart to find the correct pin length for a particular depth. In my kit, the other manufacturers I have set up are Schlage (blue), Sargent (white), Kwikset (yellow), and Yale (red). There is room for three or four dots per compartment.

David Hartley  
Connecticut

\*\*\*\*\*

If you're having trouble aligning the dial ring and lock, when installing a new combination in a fire file or security cabinet, this Technitip should help you align the dial ring for a perfect fit and smooth operation.

Make an alignment tool from a dial spindle. Most of my work is with Sargent & Greenleaf 8400 series locks, so I

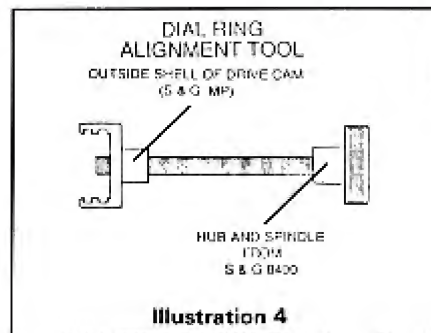

have used a spindle with the dial bearing on it and an old drive cam for this tool. (See illustration 4.) After installing the lock, hold the dial ring in place using the alignment tool. This will place the dial ring in perfect alignment with the lock case. After securing the dial ring to the outside of the safe door, remove the alignment tool and install the new dial and drive cam. It should operate with a perfect fit. You can then dial without turning hard or encountering tight spots caused by misalignment.

I hope this will help fellow locksmiths, as proper dial ring/lock case alignment is very important to smooth operation of the lock.

Lew Noyes  
Florida

\*\*\*\*\*

**Lockmasters has a 44 year history of training security professionals.**

[Click here for more information](#)



As a Technitip, here's a quick and handy chart to use for determining some more important lock features on the GM autos since 1935. While all of this information is readily available from various sources and publications, I have never seen a simple and concise guide that would contain all this information in one place. Illustration five is my quick reference chart.

M.W. Newman  
New York

GENERAL MOTORS QUICK REFERENCE CHART

YEAR	CODE LOCATION		IGNITION LOCATION	PRIMARY KEY FITS	DOOR PAWL	KEY BLANKS
	PRIMARY	SECONDARY				
35-66	IGNITION	GLOVE	DASH	IGNITION	FREE	GROUVE 15
67-68	AND	AND		AND		DOOR
69	DOOR	TRUNK	COLUMN POKE RETAINER	IGNITION	FIXED	
70-73		GLOVE ONLY				COLUMN SCREW RETAINER
74-77	IGNITION		NONE	ONLY	J & K = 70, 74, 73, 82	
78						
79	ONLY					
80						
86						

Illustration 5 →



## Installation Tools

# The Professionals Choice

[Click here for more information](#)

\*\*\*\*\*

This Technitip is for the installation of a deadbolt in a travel trailer. In many cases, the inside screen door and the outside door are too close together to allow for the installation of a deadbolt, let alone allow the customer to operate the deadbolt from the inside without cutting a hole in the screen. A simple solution for this problem is to install the deadbolt in the body of the trailer beside the door rather than in the door. The deadbolt then will extend from the jamb into the door rather than from the door into the jamb. A long backset can be used to dodge any obstructions near the door and the screen-door will not need to be modified. This procedure makes a neat job, and my customers have been very pleased with the job.

I'm hoping this Technitip will help some other locksmith please his customers who may have the same problem.

Don Crowl  
California

\*\*\*\*\*

This Technitip is in reference to the horizontal lock rod manipulation tools we use, that have the wire to assist in moving the linkage. I've found that there are two things that go wrong with these great tools. The first is that the wire or pull cord breaks, and the second is that the rubber coating on the hook wears off.

The following is a simple and inexpensive repair and maintenance tip for these tools. An inexpensive replacement wire, which will outlast the original, can be made from nylon coated wire fishing leader material (60 lb. test). Go to your local sporting goods store and purchase a roll of leader material and a package of #62 connector sleeves. You will have enough material to make about 16 wires and still have enough



leader material to make a few fish leaders for next spring.

While you're out, buy a can of plastic dip, the material used to coat handles for a better grip. Clean the worn rubber coating off the opening tool and re-coat the tool with new plastic dip. If you dip the ends of the leader wires in the plastic dip, it will seal down any sharp ends and protect your fingers.

Ronald Conley  
Texas

\*\*\*\*\*

This Technitip is for the removal of the spear head plastic clips used on the GM slide lock glove box locks that use the sidebar type lock. The front and rear plates that enclose the lock are held together by special clips. These pointed clips have four points that must be compressed to release the clip and separate the plates. If the plates are

pried apart without compressing the clips, the points can break off, ruining their holding power.

The answer to this problem is to use an 1/8" nut driver to compress and push the clips through the top plate. (See illustration 6.) Place the nut driver over the clip and push down. The head of the clip will be compressed and pushed through the hole in the top plate in one operation.

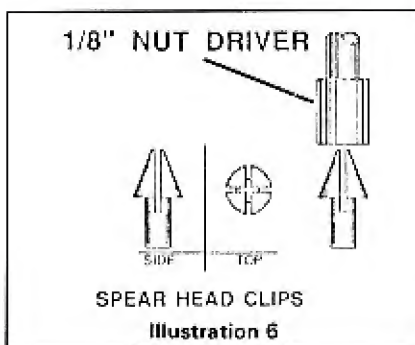

The code for the doors and trunk can be found easily by picking the lock using pressure on the side bar and reading the tumblers with a decoder. This method is a lot easier than removing a door or trunk lock, as these locks usually contain all six cuts for the key.

Charles Sullivan  
New Jersey

\*\*\*\*\*

This Technitip concerns a problem I encountered in tightening the rose thimble on Corbin locks. The problem locks are in a laundry room of a hospital. Because the laundry employees were causing considerable damage to the locks by running into them with the laundry carts, I suggested that knob protectors be installed that would prevent the carts from hitting the knobs.

A block of wood was mounted under the knob, on both sides of the door. This ended the problem of damage to the knobs, but it caused another problem. Tightening the rose thimbles which secure the lock tightly to the door was impossible. The spanner wrench could not be turned completely around because of the knob protectors.

The simple solution to this problem was to drill three additional holes in the rose thimbles. The spanner hole, in the thimble, measured 3/32." Three more holes were drilled, equal distance around the thimble. The spanner can now engage the thimble at any of four positions, allowing the lockset to be tightened without removing the knob protectors.

This is a simple solution, but very effective if there is an obstruction that prevents you from tightening the spanner type rose thimbles common to Corbin, Russwin or the heavy duty Schlage locksets.

Vito Ancona  
Maine

\*\*\*\*\*

**medeco**<sup>®</sup>  
HIGH SECURITY LOCKS

The market leader  
in locking systems  
for security, safety,  
and control.

[Click here for more information](#)



# Newsmakers

New Products and Industry News

## Code Book Set From The National Locksmith

The National Locksmith has developed a complete code books program for locksmiths. The books are completely up to date and include all the latest series. In fact the codes books contain approximately 1.3 million codes in all. The National Locksmith code book program also includes a special Code Hotline for book owners. This is a free telephone hotline locksmiths can use when they have a question or problem related to their code books.

The system is composed of the General Code Books (NGCB), the Foreign Car Books (NFCB) and the Padlock Code Books (NPCB). The code books are priced very competitively and will be updated each and every year.

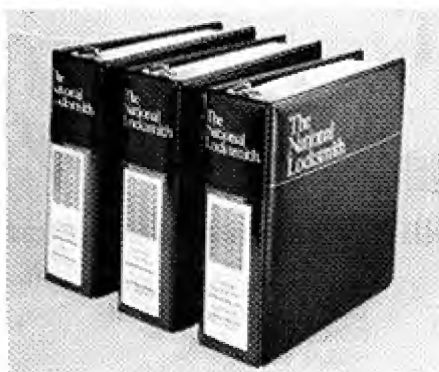

Circle 240 on Rapid Reply

## Windsor Industries Products For Locksmith Mobile Units

A new system provides hassle-free storage of key blanks in locksmith vans. This design is geared toward mobile units and is endorsed by a qualified locksmith.

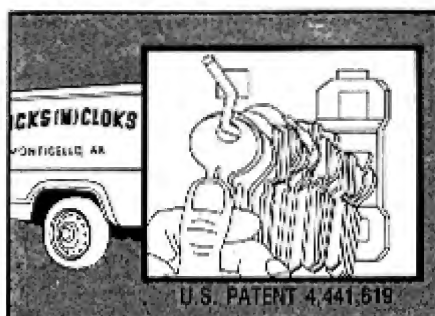

Store as many as 1,280 key blanks on a 23" x 25" 20 gauge steel board. Patented hooks screw into the toolboard and are impossible to remove without disengaging the loc-screw. Key blanks cannot come off even on roughest roads.

Windsor Industries of Akron, OH has these and other storage products in stock for immediate delivery.

Circle 242 on Rapid Reply

## Schlage "A" Lock Service Manual

Schlage Lock Company has announced the availability of a technical service manual for the Schlage "A" series lock, (product #MS C61). The 31 page manual contains a complete listing of parts and assemblies for the "A" series locks manufactured from 1984 through current.

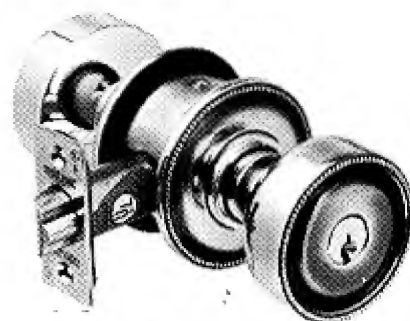

For easy reference, the manual has exploded views of each lock function. A "call out" chart of the component parts is detailed with each function and can be used as a guide for ordering individual parts. The manual also provides other comprehensive information relative to lock ordering procedures.

Circle 241 on Rapid Reply

**NATIONAL**  
AUTO LOCK SERVICE, INC.

National Auto Lock Service, Inc. offers a wide range of equipment and services for the Automotive Locksmith. From tools and hard to find key blanks to transponder programming, we can take the mystery out of car service. We accept credit card orders, and can ship COD. Contact us for the latest in automotive technology.

[www.laserkey.com](http://www.laserkey.com)



## Meilink Passes U.L. Fire Rating

Meilink Safe Company recently passed the Underwriters Laboratories fire test on its UL approved Class TL30 burglary composite safes. End users seeking both fire and burglary protection, backed by the assurance of UL listings will no longer have to choose between the two.

The safes will carry the Class 350 - 1 hour Insulated Filing Device label along with the Burglary TL30 listing obtained when Meilink's composite safe was first developed. The composite safe line is available in a full range of popular sizes.

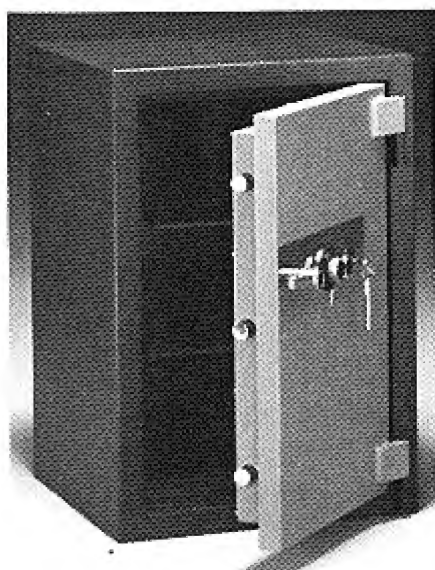

Circle 244 on Rapid Reply

## Yale Introduces Cylindrical Key-In-Lever Lockset

Yale Security Inc. has introduced the AU 5400 Series heavy duty cylindrical key-in-lever lockset with the Augusta lever design. This lockset answers the demand for a cylindrical version of the Augusta lever handles design usually found only on mortise locks. The AU 5400 also is a retrofit product for upgrading in order to meet handicap codes in doors pre-cut for cylindrical locks.

The AU 5400 is available in a variety of functions and finishes, and offers the following special features: Latchbolt projection of 1/2"; a standard 6-pin cylinder, with 7-pin and high security cylinders also available; separate auxiliary springs for each lever to prevent sagging; a free-wheeling feature that lets lever handles depress when locked without retracting the latch, thus offering greater strength and security while

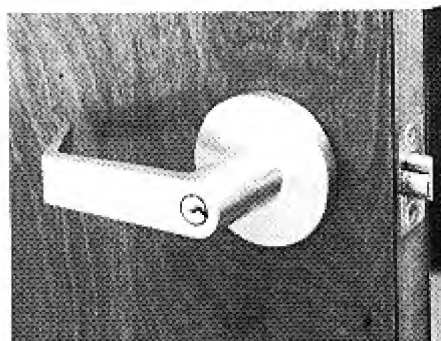

detering vandalism; and they are able to be through-bolted for extra strength and security.

The new Yale product is UL approved and meets ANSI grade 1 requirements. It is less costly to install than lever handle mortise locks, and is compatible with Yale's Augusta trim mortise lock and AU 5300 cylindrical lock design.

Circle 243 on Rapid Reply

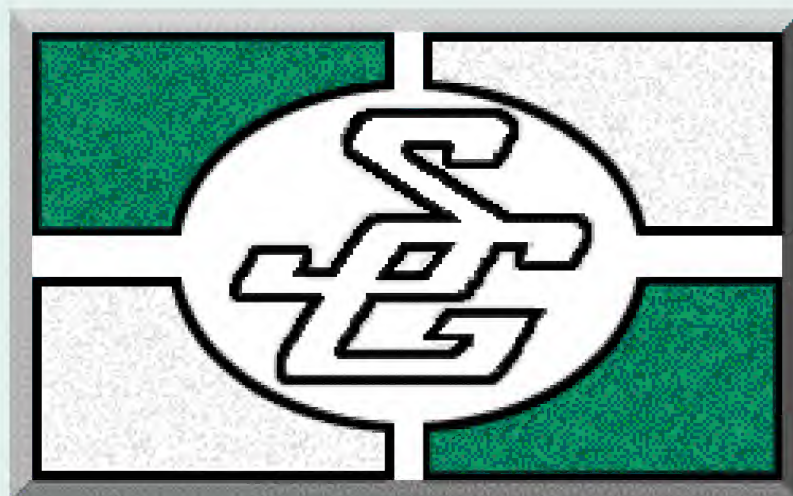

**MAKE SARGENT &  
GREENLEAF'S  
COMPTRONIC LOCKS  
YOUR CHOICE  
FOR ELECTRONIC  
SAFELOCKING  
SOLUTIONS.**

[Click here for more information](#)



### Hardware Sales Announces New Mini-Catalog

Hardware Sales & Supply Co. has just introduced a new 64 page mini-catalog, to be published quarterly. Unlike other catalogs in the locksmith industry, it features special promotions, upcoming classes, a wide range of competitively priced products, and the new Key Plus Club program.

The premiere issue was in October. It is available to all locksmiths in the Midwest.

Circle 247 on Rapid Reply

### DBD Enterprises' Stationmate

DBD Enterprises announces the introduction of a new line of safe and vault tools which will be sold under the name Stationmate.

The first product to bear the new name is the Safe Jig. Its job is to simplify the servicing of small safe doors. It will accommodate round safe heads up to 70 lbs., and square and rectangular doors up to 24" high. With the door securely held in the

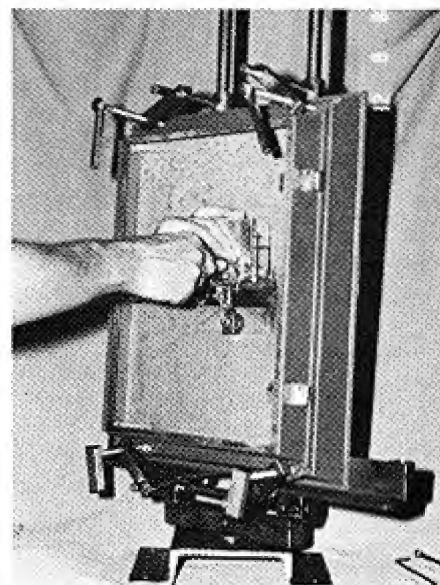

jig, it will tilt back 90° for easy loading, or may be fixed at any convenient work angle. The jig may also be rotated a complete 360°.

The jig's range of movement can minimize the time needed for combination changes and dial replacement, and allows for easy access to the front and back of the unit. It also minimizes the risk of injury to the technician by holding the unit securely in place as it is being worked on.

Circle 249 on Rapid Reply



## SCHWAB CORP.

*Fire protection for your vital records.*

**It's not safe  
unless it's  
Schwab Safe.**

[Click here for more information](#)

### The Club From Winner International

"The Club" is an anti-theft device that comes in two versions, one for automobiles and one for trucks, from Winner International.

It works as a slide and lock brace that locks onto and across your steering wheel. Once it's locked in place, the extension end makes it impossible to turn the steering wheel. When attempting to turn the steering wheel, the end is stopped by anything immovable; the windshield, the door post, or the seat. "The Club" is made out of tempered steel and uses a flat-key, double-tumbler locking system. There are 1000 variations of the keys. The Clubs will come with two keys.

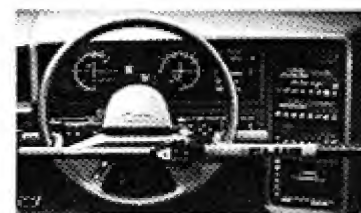

Circle 248 on Rapid Reply



## Hartwell Corporation's New Padlock Hasps

The Hartwell Corporation is announcing a new line of padlock hasps that are designed to prevent the use of bolt cutters and prying tools on an installed padlock.

Once mounted, the new hasp, named Shack'L Shield<sup>®</sup>, wraps a shroud of 1/8" stainless steel around a padlock's vulnerable shackle.

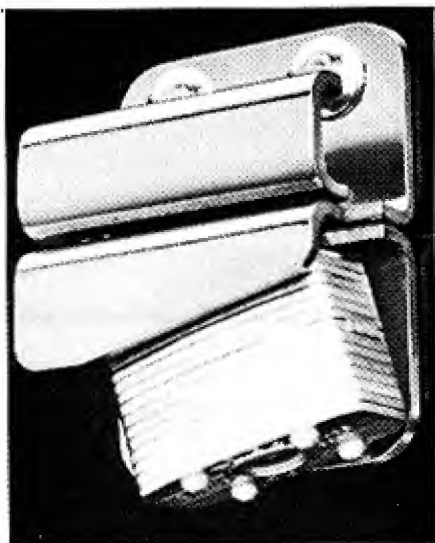

Ideal for tool boxes, store rooms, high voltage cabinets, boat hatches, vending machines, and other maximum security areas, the patented hasp design also eliminates the exposed staple that typical hasps employ and installs with 1/4" through bolts instead of small wood screws.

The Shack'L Shield<sup>®</sup> hasp is easy to mount and is available in four styles and three popular padlock sizes: 1 1/2", 1 3/4" and 2".

Circle 351 on Rapid Reply

## Ultra Hardware's Jimmy Proof Locks

The Ultra Jimmy is Ultra Hardware's convertible jimmy proof door lock. Made of solid forged brass, the Ultra Jimmy has a patented convertible locking mechanism that allows you to select your choice of single or double cylinder operation with a turn of the key.

Other features include concealed screw application with no exposed screws for security and appearance, and twin vertical interlocking deadbolts of hardened steel for indestructible operation. The design allows the

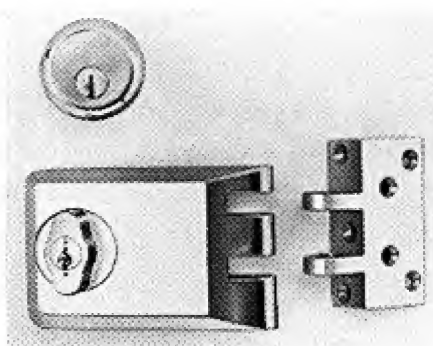

locks to be used as either a double cylinder or single cylinder jimmy proof lock at your selection. It's also convertible. When the key is turned placing the two dots one directly over the other on the inside cylinder, then the inside turn knob cannot be operated without the use of the key.

Circle 288 on Rapid Reply

**SRI**  
SECURITY  
RESOURCES INC.

***SRI and Steve Young are  
working together to bring  
you the best in locksmith  
tools and supplies.***

[Click here for more information](#)



# 1989 Locksmith Directory

This directory contains the names, addresses, and phone numbers for the hundreds of manufacturers and distributors serving the locksmith industry. Each company has been given the opportunity to write a short paragraph about themselves. This gives you the chance to learn more about the various companies in the industry.

Save this issue for reference throughout the year of 1989. If you ever have a question, problem, order, or a comment to make, you can use this Locksmith Direc-

tory to help you get results. Remember, these companies exist to help you, the locksmith. But they cannot become more responsive to you if you do not keep in contact.

We have tried very hard to make this Locksmith Directory complete with all the information you might need during the upcoming year. However, it is possible that some information might have inadvertently been omitted. If this is the case, then a future issue will contain an addendum to this list.

## Manufacturers

**A-1 Security Mfg. Corp.**  
P.O. Box 29478  
Richmond, VA 23229  
(804) 747-0095

**Aable Locksmiths**  
91-10 Liberty Ave.  
Ozone Park, NY 11417  
(718) 847-1377

Key Personnel: Frank Markisello,  
Owner; Elizabeth Markisello

We design and sell several tool kits for working on auto locks: the "Side-Kick" and "Disc-Out." We are locksmiths trying to make our jobs a little easier.

**Aanon Corporation**  
1812 Valtec Lane  
Boulder, CO 80301  
(303) 444-6990  
Key Personnel: Brian Hambleton, Pres.

Aanon Corporation carries a complete line of burglary, fire and media safes, including TL-15 and TL-30 and "FasTrac" customizing. Aanon safetron electronic locking systems provide special hold-up protection.

**A & B Safe Corporation**  
2300 W. Bloomingdale  
Chicago, IL 60647

(312) 342-0068  
Key Personnel: Frank Bernath, Nell Bernath

**ABC Lock Co.**  
P.O. Box 6033  
Omaha, NE 68102  
(402) 346-8338  
Key Personnel: Don Parkins, Owner

Keybox: metal key storage boxes for service trucks and shops. Rod Biter, Button Biter and Door Jack tools: Dog Tooth, Vampire, Zero, car and truck opening tools with teeth.

**Abloy Security Locks**  
6200 Denton Dr.  
Dallas, TX 75235  
(214) 358-4762  
Key Personnel: Jim Jeffrey, Pres.; Mark Imhof, Mktg. Svc. Mgr.; Joe Redmond, Production Mgr.

High security key operated lock cylinders, which are virtually impossible to pick; provide excellent physical strength, masterkeying possibilities and key control; plus work under all types of hostile environmental conditions. Featuring the patented Abloy Disklock mortise cylinder, mortise/rim cylinder, key-in-knob cylinders, padlocks, cam locks, and tubular deadbolts.

**Abus Lock Co.**  
218 W. Cummings Park  
P.O. Box 2367  
Woburn, MA 01801  
(617) 935-8370 (800) 225-5348  
Key Personnel: S.S. Crissman, Pres.; A.J. Steffenberg, VP; Lena Stoia, Sales Mgr.

**Adams Rite Manufacturing Co.**  
4040 So. Capitol Ave.  
City of Industry, Ca 91749  
(213) 699-0511  
Key Personnel: P.D. Adams, Pres.; T.J. Grady, VP/GM; R.S. Clark, Dir. of Sales.

Hardware for metal and glass doors: locks, latches, handles, electric strikes, exit devices, etc.

**Adcor Electronics**  
4080 Shirley Drive S.W.  
Atlanta, GA 30336  
(404) 691-8920  
Key Personnel: Robert C. Montgomery, President

Products include NW422 AC Tape Dialer, CDR/P-250 Digital Receiver and Printer, ACE-600 Control/Communicator and TLM.5 Telephone Line Monitor.



#### **Ademco**

165 Eileen Way  
Syosset, NY 11791  
(516) 921-6700

Key Personnel: Leo A. Guthart,  
Pres.; Steve Roth, VP.

Ademco offers a complete line of electronic security systems and components, including wireless and hardware equipment. Ademco Distribution has more than 35 convenience outlets offering products of most major manufacturers, including the complete Ademco product line.

#### **Adesco Safe/Star Safe & Alarm, Inc.**

16720 S. Garfield Ave.  
Paramount, CA 90723  
(213) 774-0081  
(800) 821-6803

Key Personnel: Gene Halls, Pres.; Dee Diederich, VP California;  
David Halls, VP Georgia.

Star Safe & Alarm, brand name "Adesco" has been manufacturing safes for the locksmith/safe dealers for half a century. In floor safes up to TL-15 label, upright safes to TL-30 label and imported fire safes. Factory located in

California serving the West Coast, and Georgia serving the Eastern States.

#### **Adrian Steel Co.**

906 James St.  
Adrian, MI 49221  
(517) 265-6194

Key Personnel: Karen Mohler,  
Sales Coordinator.

Service van interior equipment (i.e. drawer units, cabinets, shelving, bins), safety partitions and ladder racks for full size and mini vans.

#### **Advance Car Mover Co., Inc.**

112 N. Outagamie St.  
P.O. Box 1181  
Appleton, WI 54912-1181  
(414) 734-1878

Porter spring winder makes extension and compression springs up to 1¼" I.D. from wire up to 3/16" diameter. Hook on spring looping tool forms perfect loops and hooks on springs to ½" OD. Other accessories include cut-off nipper for hard wire and packaged music wire to 3/16" diameter.

#### **Aiphone Intercom System**

1700 130th Ave. N.E.  
Bellevue, WA 98005  
(206) 455-0510

Key Personnel: Jim Morrison, Nat'l.  
Sales Mgr.

Aiphone offers intercom systems for home, business, and industry. From simple two-station to complex commercial and industrial systems, Aiphone intercoms emphasize design simplicity, technical excellence, and reliable performance.

#### **Alarm Electronics Mfg. Co.**

Rt. 2, Box 70  
Taylorsville, NC 28681  
(704) 632-3365

Key Personnel: Ed Bonner

Manufacturer of miniature wireless transmitters styled as wristwatch, pendent, or key ring used for holdup, medical, auto alarm, door strikes and many other applications.

#### **Alarm Lock Systems, Inc.**

10 Old Bloomfield Ave.  
Pine Brook, NJ 07058  
(201) 944-0909, (800) 678-LOCK  
FAX: (201) 808-9189

Key Personnel: Richard Paladino,  
Nat'l. Sales Mgr.

Alarm Lock is a major manufacturer of door alarm devices with production facilities in Pine Brook, NJ. They distribute throughout the US and internationally.



# STRATTEC™

## It's your reputation.

## Trust the original.

[Click here for more information](#)



**Al-Ert Mfg. Co.**  
30 West Old Country Rd.  
Hicksville, NY 11801  
(516) 931-2262  
Key Personnel: Al Carracino, Pres.

**All-Lock Co., Inc.**  
P.O. Box 3042, U.S. 1 and 130  
No. Brunswick, NJ 08902  
(201) 545-7000  
Key Personnel: Ronald B. Hermann,  
Pres.; Stan Fuse, VP Sales; Brian P.  
Strom, Field Sales Mgr.

Domestic and foreign automotive locks  
and service kits, key blanks, cam locks  
and service kits, training seminars, and  
credit cam keys.

**Allied•Gary**  
10080 Alliance Drive  
Cincinnati, OH 45242  
(513) 791-1511, (800) 543-8682  
FAX: (513) 791-8625

Manufacturers of quality burglary  
money chests, cash handling equip-  
ment and bank equipment.

**Almont Lock Co.**  
113 School St.  
Almont, MI 48003  
(313) 798-8950  
Key Personnel: A. Popovici, Pres.; G.  
Wells, VP; W.L. Pluck, Mktg. Mgr.

**American Automotive  
Security Systems, Inc.**  
1371 Southside Dr.  
Salem, VA 24153  
(703) 387-2886  
Key Personnel: Wes Burnette, Pres.

The Bulldog Security System combines  
an ignition interrupt unit with an auto-  
matic hoodlocking device designed to  
protect your car against theft and  
engine tampering. This includes a  
Medeco UL listed high security lock,  
virtually pick proof. We also offer the Bul-  
ldog Alarm System.

**American Lock Co.**  
3400 W. Exchange Rd.  
Crete, IL 60417  
(312) 534-2000  
Key Personnel: George Junkunc,  
Pres.; Ken Erikson, VP Sales & Mktg.; Bill  
Walsh, Sales Mgr.

Manufacturer of solid steel and solid  
brass padlocks, hasps, cam locks, inner  
cylinder locks, replacement rim and  
mortise cylinders and combination  
padlocks.

**American Locksmith Service**  
1800 E. Miraloma Ave., Unit D  
Placentia, CA 92670  
(714) 528-5500  
Key Personnel: John Redd, GM.

For more than 15 years, American  
Locksmith Service has been manufac-  
turing and supplying quality locksmith  
tools like the Slim Jim® to the locksmith  
trade throughout the U.S. We manufac-  
ture more than 20 different specialty car  
door openers and locksmith  
accessories.

**American Security Products Co.**  
11925 Pacific Ave.  
Fontana, CA 92335  
(800) 421-6142  
Key Personnel: Kyle Walters, Pres.;  
Mike Glenn, Sales Mgr.; Ron Remlin-  
ger, Srv. Mgr.

Manufacturer of AMSEC, Star and major  
burglary and fire resistant safes.

**American Shield Corp.**  
2550 Beckley Meade Ave., Ste. 100  
Dallas, TX 75237  
(214) 709-5555  
Key Personnel: Alain Varenne, Pres.;  
Don Fowler, VP-GM; Jana Bevers,  
Associate

Represents the finest European manufac-  
turers of commercial door hardware.  
Key lines include JPM 90 series and JPM  
8000 series exit devices.

**Amsco•Valley Forge**  
101 Corporate Drive  
Hauppauge, NY 11788  
(516) 435-1400  
NY: (800) 832-8898  
USA: (800) 645-5604  
Key Personnel: Mel Minoff, Pres.; Sal  
Saccullo, VP

Automotive Manufacturing and Supply  
Co. purchased Valley Forge Products  
Co. Inc. from Avnet on April 1, 1988.  
Amsco•Valley Forge will be updating  
and increasing their coverage of for-  
eign and domestic automotive ignition,  
door and trunk locks in the near future.

**Anes Electronics**  
4112 Del Rey Ave.  
Marina Del Rey, CA 90292  
(213) 821-8808, (800) 826-2419 (CA),  
(800) 445-8458 (Nat'l.)  
Key Personnel: Shel Kirshner, Pres.;  
Edie Kirshner, Exec. VP; Tom Molter, VP  
Sales/Mktg.

Complete automotive security, steering  
wheel locks, hood and trunk locks, and  
other mechanical locks.

**A.P.I. Group**  
375 Rabro Dr.  
Hauppauge, NY 11788  
(516) 582-1581, (800) 221-3546  
Key Personnel: Manny Lopez, Pres.;  
James Woodson, Sales.

Specializing in apartment or condo-  
minium alarms, all self-contained.  
Ideally suited to the locksmith trade. We  
also manufacture tape and digital  
dialers and micro-processor controls.

**Arizona Lock Technology**  
P.O. Box 61302  
Phoenix, AZ 85082  
(602) 225-9385  
Key Personnel: Mark MacLeod

**Armor Safe Corp.**  
1435 Grand Ave.  
San Marcos, Ca 92069  
(619) 744-4992

Complete line of UL labeled TL-15, TL-30  
burglar resistive money safes for super-  
markets and drug chains. B and C rate  
floor safes. UL 350 one hour fire resistive  
record safes. Special designs for fast  
foods.

**Armstrong Security Lock Corp.**  
54-45 44th St.  
Maspeth, NY 11378  
(800) 622-LOCK, (718) 392-9000  
Key Personnel: Mark Berger, Nat'l.  
Sales Mgr.

A Division of Securitech Group, Inc.,  
Armstrong created the 2-Inch dead-  
bolt, top rated by Consumer Reports.  
DoubleThrow projects a full two inches  
while leaving 3/8" of solid steel inside the  
door. New 1 1/2" throw model also avail-  
able for special applications (narrow  
jambs, sidelights, etc.).

**Arrow Lock Corp.**  
103-00 Foster Ave.  
Brooklyn, NY 11236  
(718) 257-4700  
Key Personnel: E. Pugatch, Pres.; L.  
Kunz, VP Martin Rosenfield, Contract  
Sales Mgr.

Full line of door locks—cylindrical, mor-  
tise, tubular deadlocks and interchan-  
geable cores, locks and tools.

**ASSA, Inc.**  
2600 Warrenville Rd.  
Downers Grove, IL 60515  
(312) 968-3774, (800) 323-6363  
Key Personnel: James J. O'Halloran,  
VP, Eastern Region; Stefan B. Birgh, VP,  
Western Region

Continued on page 34

November 31



**ASSA, Inc.**

*Continued from page 31*

Manufacturers of ASSA Twin® highsecurity and 600 series retrofit lock cylinders, tubular deadbolts, padlocks, HALT® narrow stile locks and commercial grade full mortise lever-handle locksets. All ASSA products are sold through traditional locksmith wholesaler, contract hardware and O.E.M. distribution channels.

**Audio Alert Systems**

4208 Dover Rd.  
Louisville, KY 40216  
(502) 448-6699  
Key Personnel: Glenn Isaacs

**Auto-Security Products**

P.O. Box 2937  
Kirkland, WA 98083-2937  
Key Personnel: Buddy Logan, Pres.;  
Dick Brandon, Marketing Mgr.

Replacement locks, lock parts, keying kits, etc. For over 30 makes of Asian and European vehicles.

**AWI/Vingcard Systems**

6200 Denton Dr.  
Dallas, TX 75235  
(214) 358-4631  
Key Personnel: Peter Wilson, Pres.;  
Diana Guzman, Sales Mgr.

Manufacturer of original equipment and replacement mortise, rim, t-tum and dummy cylinders. Also the Convert-A-Lock™ cylinder file guard and Welch products.

**Baldwin Hardware Corp.**

841 E. Wyomissing Blvd.  
P.O. Box 15048  
Reading, PA 19611  
(215) 777-7811  
Key Personnel: Peter Fayerman, Pres.;  
Bruce Campbell, Dir. Sales/Mktg.;  
Wayne Baker, Nat'l. Sales Mgr.

Baldwin manufactures forged brass residential and commercial locks, trims and other architectural hardware and offers a full range of lock functions and trim designs. Locks are available with various backsets. Products are especially designed for use on high-end custom residential and commercial projects.

**Belwith International**

18071 Arenth Ave.  
City of Industry, CA 91748  
(818) 965-5533  
Key Personnel: Hugh Heflin, Pres.; Bill Skelly, Nat'l. Sales Mgr.

Belwith offers a complete line of auxiliary security devices. Full line of padlocks, window locks, keyed window locks, keyed door locks, night latches, deadbolts, keyed specialty locks. Locksmith in store display merchandisers also available.

**Blank Plastics**

225 Rivermoor St.  
Boston, MA 02132  
(617) 325-9600  
(800) 225-4375  
Key Personnel: Eric Blank, VP Mktg.;  
Michael Blank, VP Sales; Eric Domschne, Sales Mgr.

Blank Plastics is a major manufacturer of printed plastic products for the security and lock industries. Blank's product line includes high security access entry cards, credit cards, I.D. cards and systems plus parking tags and visitor badges. Blank also manufactures custom imprinted promotional products like Stor-A-Key, a credit card that holds two spare keys on one side and a promotional message on the other. A perfect business card or give away for locksmiths, banks, or any security company.

**Borroughs Tool**

2429 N. Burdick  
Kalamazoo, MI 49007  
(616) 345-2700  
Key Personnel: F. Survilla, GM; Jeff Matson, Pur.; Phil Eve, Eng.

Service tools for GM automotive lock systems.

**Bridgeman**

1511 E. Edinger Ave.  
Santa Ana, CA 92705  
(714) 543-2691, (800) 854-6293  
Vault doors, vault panels, TL-15 Ongard and TL-30 Crossgard safes, safe deposit boxes and lockers, card access control units, point to point pneumatic carrier systems, pneumatic drive-up systems, "X-4" safe deposit box locks.

**Briggs & Stratton**

P.O. Box 702  
Milwaukee, WI 53201  
(414) 259-5218

**R.R. Brink Locking Systems Inc.**

500 Earl Road  
Shorewood, IL 60436  
(815) 744-7000  
FAX: (815) 744-7020  
Key Personnel: Robert R. Brink, Pres.;  
Diane M. Ganster, VP Operations;  
Raymond V. Kambic, VP/Chief Designer

R.R. Brink Locking Systems manufactures electromechanical locks and custom control systems with emphasis on detention hardware. Accessories include door position switches and security door pulls. Extra-heavy-duty electric locks for swinging and sliding doors along with track assemblies are recent additions to the line.

**Brookfield Industries**

99 West Hillside Ave., P.O. Box 548  
Thomaston, CT 06787  
(203) 283-6211  
Key Personnel: Karl Kinzer

**Brown Safe Manufacturing**

439 West San Marcos Blvd.  
San Marcos, CA 92069  
(619) 744-4888  
Key Personnel: Fred Brown, Melissa Brown

**Buddy Security Systems**

1350 S. Leavitt  
Chicago, IL 60608  
(312) 733-6400  
Key Personnel: Sam DiFiglio Sr., Sam DiFiglio Jr.

**California Security Cans**

530 Cypress Ave.  
Hermosa Beach, CA 90254  
(213) 374-9615  
Key Personnel: Margaret Meenahan

**Cannon Safe Inc.**

9358 Stephens St.  
Pico Rivera, CA 90660  
(213) 692-0636, (800) 222-1055 (CA),  
(800) 242-1045 (Nat'l.)  
Key Personnel: Steve Baker, Pres.;  
Richard J. Rundell, GM

Manufacturers of various size safes ranging from 7 cubic feet to 55 cubic feet as well as small size safes for individual use. Large safes are designed as gun safes but are adaptable for any use.

**Capricorn Electronics Inc.**

Hwy. 321 South, P.O. Box 66  
Maiden, NC 28650  
(704) 428-3451 (NC),  
(800) 438-3750 (Nat'l.)  
Key Personnel: Keith Long, Pres.; Bill Gronning, VP Eng.; Robbie Roberson, VP Op.

Complete burglary and emergency wireless/hardwire systems. Identification of up to 48 individual keypad, smoke, handheld, window/door, miniaturized pendant, glassbreak, transmitters, etc. Hardwire zones identified also.



#### **CCL Security Products**

321 Ellis St.  
New Britain, CT 06050-4360  
(203) 229-6199

Key Personnel: Thomas Salonia, Dir. of Sales/Mktg.; Jim Madigan, Nat'l. Sales Mgr.

CCL Security Products manufactures and markets a complete line of locking devices featuring Sesamee padlocks, keyed padlocks, handles and key-blanks. We are a member of the Eastern Company Hardware Group which includes Illinois Lock Company and Eberhard Manufacturing.

#### **Centurion Deposit Corp.**

237 Highland Pkwy.  
Roselle, NJ 07203  
(201) 241-9277

Key Personnel: E.L. Bianco, Pres.

Depository safes and money chests produced to world class specifications.

#### **C.H.A.M.P.S. Mfg.**

P.O. Box 473  
East Wareham, MA 02538  
(617) 423-4846  
(800) 828-4600

FAX: (617) 227-7611

Key Personnel: John McKernan, Pres.

Manufacturers of C.H.A.M.P.S. Lock Protection Devices.

#### **Chicago Lock Co.**

4311 W. Belmont Ave.  
Chicago, IL 60641  
(312) 282-7177

Key Personnel: Dale N. Padjen, Sales Mgr.

With over 66 years experience manufacturing locks, our reputation for quality products is known throughout the industry. Our stock and made to order products can be ordered directly or through local distributors.

#### **Circle-Ess, Inc.**

214 East 2 St.  
Hastings, NE 68901-5217  
(402) 462-2737

Key Personnel: B.G. Sager, Pres.; H. Roger Grace, Sec'y./Treas.

Main products, Circle-Ess MB8202 key cutting machine. Operates from 12 volts AC or DC or 120 volts AC 50-60 cycles. May be re-wired for use on 220 volts to 250 volts.

#### **Clifford Electronics**

20750 Lassen St.  
Chatsworth, CA 91311

(818) 709-7551

Key Personnel: Keith Field

#### **CMW International Corp.**

2101 Midway Rd. Suite 250  
Carrollton, TX 75006  
(214) 960-2680

Key Personnel: Francis Choy, Exec. VP

"Solex 123" key duplicating machine, a unique 3-cutter machine that cuts cylinder, flat steel, Abloy and tubular keys. Most versatile with variable speed motor. "Vaultron" electronic home safe with alarm. "Solex" high security steering wheel lock.

#### **Code-Alarm Vehicle Security Systems, Inc.**

32021 Edward  
Madison Heights, MI 48071  
(313) 583-9620

FAX: (313) 585-4799

Key Personnel: Rand Mueller, Pres.; Geoff Dixon, VP Sales & Mktg.; Jay Smith, Nat'l. Sales Mgr.

#### **Code-Alarm Home Security Products**

32021 Edward  
Madison Heights, MI 48071  
(313) 583-9620  
FAX: (313) 585-4799



***ASP Covers the World of Auto Locks***

[Click here for more information](#)



Key Personnel: Rand Mueller, Pres.; Geoff Dixon, VP Sales & Mktg.; Jay Smith, Nat'l. Sales Mgr.

**Continental Instruments Corp.**

70 Hopper St.  
Westbury, NY 11590  
(516) 334-0900

Key Personnel: Michael Morgenstern, Pres.; John Banks, VP; Robert Weinstein, Product Mgr.

Access control systems that control from one to hundreds of doors and thousands of card holders and also monitors alarm inputs. Your choice of Hands-Free™ proximity, Wiegand effect, magnetic stripe or infrared reader technology. All systems are available with English language printout. Cypher® Lock, electronic combination lock.

**Continental Micro, Inc.**

P.O. Box 394  
Park Ridge, IL 60068  
(312) 692-3630

Key Personnel: Thomas Swiderek, Pres.; Lori Lane, V.P.

**"Controller Systems" Corporation**

21363 Gratiot Ave.  
East Detroit, MI 48021  
(313) 772-6100

Key Personnel: Henry J. Luks, Pres.

Manufacturers of wireless equipment since 1970. Stand-alone units for residential, condo, apartments and light commercial properties. Self-contained with siren, entry/exit delays, stand-by battery and AC outlet for turning lights on and off.

**Corbin Hardware Group**

225 Episcopal Rd.  
Berlin, CT 06037  
(203) 225-7411

**Corby Industries, Inc.**

1501 E. Pennsylvania St.  
Allentown, PA 18103  
(800) 652-6729

(215) 433-1413  
FAX: (215) 435-1963

Key Personnel: Jeffrey Anthony, Sharon Cain, Richard O'Donnell

Corby Industries, Inc., provides access control systems, accessories, supplies and digital electronic keypads for every

application. Corby systems are available for any size installation: From a single door with several hundred users to computer-based systems with hundreds of doors, multiple building locations and thousands of doors, multiple building locations and thousands of users.

**CorKey Control Systems, Inc.**

20705 S. Western Ave. #108  
Torrance, CA 90501  
(213) 533-1425

Key Personnel: Bruce Sedley, Pres.; Barry Meisels, GM

CorKey Control Systems can provide a magnetic key system that operates on mechanical magnetic door locks. This product and its quick change capabilities has been used in hotels, office and industrial buildings, parking systems, etc. The encoding the re-keying equipment will allow you to have complete control of the system.

**Crimestopper Security Products, Inc.**

1770 So. Tapo St.  
Simi Valley, CA 93063

(805) 526-9400, (800) 66-ALARM

Key Personnel: Howard Miller, Pres.; Sharon Miller, VP; Larry Peterson, GM.

*Continued on next page*



***Don't panic!  
We have Security  
Exit Devices.***

[Click here for more information](#)



**Crimestopper Security Products**  
*Continued from previous page*

Complete line of automotive security products and accessories including remote control devices, paging alarms, digital and keyless entry systems, key type systems to meet every requirement and vehicle.

**Curtis Industries, Inc.**

34999 Curtis Blvd.  
Eastlake, OH 44094  
(216) 951-2400

Key Personnel: F. Kuhar, Pres.; D. Tengel, VP Sales/Mktg.; T. Morse, Security Products Mgr.

Curtis is a leading manufacturer of key blanks; key duplicating machines, (including the #2, the Keymatic 2000, and the Keymatic 3000); the Number 15 Code Cutter; and the Number 16 Commercial and Residential Code Cutter. Curtis also distributes many additional locksmith items via its own salesforce covering the U.S., Canada and U.K.

**Custom Security Products Mfg. Inc.**

P.O. Box 4553  
Thousand Oaks, CA 91359  
(800) 522-7627 (Nat'l.),  
(805) 522-5580 (CA)

Key Personnel: Elizabeth Hughes, Pres.; John Lamel, Nat'l. Sales Rep.

Snap-A-Keys/tubular keys - no machine required. Tubular key blanks Nylon handle "A-bow" tubular keys. Greenwald, tubular key blanks. Pickmaster®. Tubular locks. Greenwald lock picks. Decoder keys. specialty tools for locksmiths.

**Dalme, Inc.**

7234 Eton Ave.  
Canoga Park, CA 91303  
(818) 712-0422

Key Personnel: Al Miller, Vincent Galliano

**DBD Enterprises**

P.O. Box 3463 CRS  
Johnson City, TN 37602  
(615) 928-6612

Key Personnel: Don Dennis, Owner

DBD Enterprises manufactures safe jigs and tools under the trademark of Stationmate. The Stationmate jigs are designed to hold safe doors while you perform the required work. The line of safe hand tools will reach the market early 1989.

**Del Norte Security Systems**

1100 Pamela Dr.  
Euless, TX 76039  
(817) 267-3541

Key Personnel: Jeff Wilson

**Detex Corp.**

302 Detex Dr.  
New Braunfels, TX 78130  
(800) 468-0112, (512) 629-2900

Key Personnel: Don N. Cameron, Pres.; Anthony L. Mudford, VP Mktg & Sales; Trice A. Kastein, Inside Sales Mgr.

Detex designs and manufactures security and safety equipment products for commercial, industrial and institutional buildings. We offer individual "off-the-shelf" units capable of stand-alone or interface into complete systems coordinated to suit a specific need. Equipment specified and installed today will be compatible to expand the security network of the future.

**Detroit Mini-Safe Co.**

9950 Freeland Ave.  
Detroit, MI 48227  
(313) 931-7720

Key Personnel: Sheldon Wiener, Owner.

All steel deposit safes for trucks, stores, theaters, gas stations.

**Dexter Lock**

300 Webster Rd.  
Auburn, AL 36830  
(205) 826-3300

**Don-Jo Mfg.**

P.O. Box 62  
Leominster, MA 01453  
(617) 534-1115

Key Personnel: Tim Roy, Comptroller; Joey Dalessio, Nat'l. Sales Mgr.

Don-Jo manufactures door filler plates, frame filler plates, latch protectors, A.S.A. strikes, security strikes, adjustable strikes and conversion plates. All products are made in the U.S.A. of quality materials and packaged with the locksmith in mind.

**Dorma Door Controls Inc.**

Dorma Drive  
Reamstown, PA 17567  
(215) 267-3881  
FAX: (215) 395-8027

Key Personnel: Steve Hildebrand

**Dynatec International**

3594 West 1820 South  
Salt Lake City, UT 84104  
(801) 973-9500

Key Personnel: Dale Gledhill

Manufacturers of: Sofstop™, the air cushioned doorstop; The Security Guard™, the simulated alarm; Cover-up Doorstop, the doorstop designed to cover damaged walls.

**Eagle Safe Corp.**

1204 Esl Drive, P.O. Box 11  
Springdale, AR 72765-0011  
(800) 225-7672, (501) 751-4251

Key Personnel: Hal S. Martin, President; Marilyn Crabtree, Cont.

**Eagle Security Systems**

641 Center Ave.  
Mamaroneck, NY 10543  
(914) 698-4811, (800) 645-7455

Key Personnel: Jack Murphy, Pres.; Ray Plunkett, Sales Mgr.

Removable core systems and products, cylindrical locks, padlocks, rim and mortise shells capping tools and parts. All your needs for 6 and 7 pin systems.

**E.O.W. Products, Inc.**

5635 Francis Lewis Blvd.  
Oakland Gardens, NY 11364  
(718) 229-4545

Key Personnel: Steve Shean, Pres.; S.K. Wu, VP; David Chen, VP.

Key cutting machines for professionals.

**ESP Corp.**

375 Harvard St.  
Leominster, MA 01453  
(617) 537-6121

Key Personnel: Vince Spadafora, V.P. Sales & Mktg.; Brian Baker, Nat'l Sales Mgr.

Manufacturer of key blanks, key duplicating machines, locksmith tools and equipment, cam locks, desk and pin tumbler, mailbox and file cabinet locks, consumer accessories including Hide-A-Key, Key Kool, Ident-A-Key, Design-A-Coil, Spiderclip and Key Klip. Other trade names: Omni Speed Bore and Proline.

**Essex Technologies Corp.**

1130 Mark Ave.  
Carpinteria, CA 93013  
(805) 684-7601  
FAX: 805-684-0232

Key Personnel: Bruce Hickox, Pres. and Chief Executive Officer; Valerie V. Diaz, Cus. Svc. Mgr.

Essex Technologies Corporation is a manufacturer of Keyless Entry® Coded Access systems for residential, commercial, elevator and automotive applica-

*Continued on page 42*



**Essex Technologies Corp.**  
*Continued from page 38*

tions. All systems include weather and vandal resistant touchpads. The residential and commercial Keyless Entry® Systems provide years of reliability and are simple to install.

**Henry A. Evers Corp.**

72 Oxford St.  
Providence, RI 02905  
(401) 781-4767  
(800) 55-EVERS  
Key Personnel: Anthony J. D'Orlo, Pres.

**Facilitrac**

325 East Southern, Ste. 11  
Tempe, AZ 85282  
(800) 843-8722  
Key Personnel: Michael Marinello, Mktg. Dir.

Grandmaster™-PC-based computerized key control software. Tracks thousands of locks, keys, personnel and all other related information. Prints 14 informative reports for locksmiths as well as the office administrator. Easy to operate, simple to set-up, with multi-level password security and on-line help. \$295 from Facilitrac™.

**Falcon Lock**

5555 McFadden Ave.  
Huntington Beach, CA 92649  
(714) 891-0384

**Ferma-Lok Inc.**

243-22 Merrick Blvd.  
Rosedale, NY 11422  
(718) 525-0568  
Key Personnel: Bruno Interrante, Pres.; Elizabeth Rollo, VP.

We are manufacturers and distributors of an effective anti-theft device for the trunk of General Motors cars.

**Fort Knox Security Products**

1051 No. Industrial Park Rd.  
Orem, UT 84057  
(800) 821-5216  
Key Personnel: Tom James, Pres.

Fort Knox is the only home security safe company using rack and pinion gear mechanisms to secure their doors. Banks have been using this system for over 100 years.

**Fort Lock Corp.**

3000 River Rd.  
River Grove, IL 60171  
(800) 323-1587. (312) 456-1100  
Key Personnel: Lloyd Falk, Pres.; John Hutzenlaub, VP Mktg./Sales

Manufacturer of round and flat key switch, cam and specialty locks. A complete series of these locks are manufactured as multi-function locks® exclusively for the locksmith. All come packaged to create many different locks all from one set of parts and are rekeyable. Contact factory to become an authorized dealer.

**Framon Mfg. Co., Inc.**

909 Washington Ave.  
Alpena, MI 49707  
(517) 354-5623  
Key Personnel: Frank Agius, Pres.

**Fulton Lock Co.**

Div. Cleidotech Systems Ltd.  
88 Fulton Street  
New York, NY 10038  
(212) 732-1314  
FAX: (212) 962-0232  
Products: Quality key machines and key blanks.

**Gardall Safe Corp.**

P.O. Box 30 Eastwood Sta.  
Syracuse, NY 13206  
(315) 455-5886 (NY),  
(800) 722-7233 (Nat'l.)  
Key Personnel: Edward Baroody, Pres.; James E. Walsh, VP Mktg.



***To be a World Leader You Need Quality Products,  
Innovative Technology and Strong Partners.***

[Click here for more information](#)



Safe manufacturer, fire resistant 1310-4820, Z series safe within a fire safe, rotary and front loading depository steel safes, cash drawer safes, custom made record safes or steel safes.

**Gil-Ray Tools Inc.**

1306 McGraw St.  
P.O. Box 801  
Bay City, MI 48707  
(517) 892-6870

Key Personnel: David J. Deuel,  
Pres.; Laurie Bedell, Cus. Svc. Mgr.

Gil-Ray Tools Inc. has manufactured premium high speed steel key machine cutter wheels since 1945. New cutters are available direct to the locksmith through their free catalog and are also available through selected distributors. Gil-Ray tools offers a dependable mail-in cutter sharpening service.

**GNI**

P.O. Box 1675  
Santa Rosa, CA 95402  
(707) 528-8083  
FAX: (707) 528-8085

Key Personnel: David A. Kesselman,  
Pres.; Shirlee Turnipseed, Mktg. Coor-  
dinator; Jack Thatcher, Production  
Mgr.

GNI designs, manufactures and markets proprietary high security fasteners, seals, locking devices and specialized security hardware for OEM accounts.

**Hampton Lock Co.**

1570 S. Acoma  
Denver CO 80223  
(303) 778-7333

Key Personnel: Jeannine  
Hampton, Pres.; Tracy Hampton, VP.

Hampton Lock Company, features weather-proof, rustproof, and waterproof padlocks. Hampton has introduced their "designer locks" for an exciting new look in padlocks for today's color-conscious marketplace. Other new and innovative products from Hampton include Lok-Box and Mini Lok-Box portable security vaults.

**Hager Hinge Co.**

139 Victor St.  
P.O. Box 12300 Souldard Station  
St. Louis, MO 63104  
(800) 325-9995

FAX: (800) 782-0149  
Key Personnel: A.W. Hager III, Pres.;  
John Wotawa, VP Sales; Frank  
Bloecher, VP Architectural Sales

Hager Hinge has been in the business of manufacturing contract grade hinges, spring hinges, electric hinges and consumer hardware for over 135 years.

**Hanchett Entry Systems,  
Inc./h.e.s., Inc.**

4112 N. 20th St.  
Phoenix, AZ 85024  
(602) 957-2472, (800) 626-7590  
Key Personnel: Leland J. Hanchett, Jr.,  
Pres.; Michael A. Webb, V.P.

H.E.S., Inc. manufactures a complete line of electric strikes, many of which are UL-listed, for burglary protection or fire door accessories. Models are available for releasing most every type of lockset on the market including those with 1" throw deadbolts. Product lines include high security, rotary, and concealed electric strikes.

**Harrison Electronic Systems**

51 Gravel St., Box 1758  
Wilkes-Barre, PA 18705  
(717) 825-0540  
Key Personnel: Karen Keefer



**HPC HAS IT ALL:  
KEY MACHINES, SOFTWARE, BOOKS, CAR  
OPENERS, PICK SETS, TOOLS, DOOR GUARDS,  
AND KEY CABINETS**

[Click here for more information](#)



**HEWI Inc.**

7 Pearl Ct.  
Allendale, NJ 07401  
(201) 327-7202  
Key Personnel: Eleanor Rinis, Mgr.  
Cust. Svc.

Manufacturer of nylon hardware in 13 colors with contemporary design and consistent styling. Product range includes door hardware, cabinet pulls, bathroom accessories, railings and handicapped support systems. Introducing new products: furniture, seating systems, lever handles and latch.

**Hiawatha Inc., J.L. Industries**

4450 W. 78th St., Circle  
Bloomington, MN 55435  
(612) 835-4944  
FAX: (612) 835-2218  
Key Personnel: Bob Dunn, Pres.; Kirby Bayerle, Nat'l. Sales/Mktg. Mgr.; Robert Dunn, Jr., Customer Service

For over 25 years Hiawatha Inc. has manufactured specialty products, including fire extinguishers and cabinets, access panels, roof hatches, floor grates, and mats, detention specialties, flat goods, tubular pulls, nylon pulls and lites, and louvers.

**High Tech Tools**

2811 S.W. 27 Ave.  
Miami, FL 33133  
(800) 323-8324  
(305) 444-6656  
Key Personnel: Tony Vigil, Pres.

Manufacturer of automotive lock-out tools. Tools are designed to unlock all GM cars, most Fords and foreign cars. Customers are notified by computer of future updates.

**Hill Specialty Products**

E. 711-17 Walton Ave.  
Spokane, WA 99207-3099  
(800) 722-1142  
Key Personnel: Ruth R. Bower, Owner/Mgr.; Ilean M. Nelson, Exec. Asst.; Toki E. Miller, Admin. Asst.

For men we manufacture the 39-N Okay's Key Safe, 37-C Okay's Key Safes (for beltless trousers), 79-N Okay's Kee Pal to wear on belt for carrying keys. For ladies we make the 52-P and 62-P Okay's Handl Keys for their keys. Clipped in purse they are easily available.

**Hirsch Electronics Inc.**

1751 Langley Ave.  
Irvine, CA 92714  
(714) 250-8888  
Key Personnel: Larry Midland, Pres.; Rick Foster, Exec. VP.

**HPC, Inc.**

3999 N. 25th Ave.  
Schiller Park, IL 60176  
(312) 671-6280  
Telex: 72-1444 (HPC SRPK)  
FAX: (312) 671-6343  
HPC Services: (800) 323-3295  
Key Personnel: Jerry Hoffman, Pres.; Alan Blitstein, VP of Sales.  
For over thirty years, manufacturer, publisher, and educator to the lock and security industry.

**Ilco Unican**

U.S.: P.O. Box 2627  
Rocky Mount, NC 27802-2627  
(919) 446-3321  
Canada: 7301 Decarie Blvd.  
Montreal, Quebec H4P 2G7  
(514) 735-5411

Key blanks: automotive, house, bit, safe deposit, flat steel, etc. Key machines: manual, automotive, semi-automatic, code and special application. Locksmith supplies, security hardware, cylinders.

**Illinois Lock Co.**

301 Hintz Rd.  
Wheeling, IL 60090  
(312) 537-1800  
Key Personnel: S.G. Sanelli, Managing Dir.

Manufacturer of locks directed toward the O.E.M. market place including cam, cabinet and switch locks. Available in a variety of mechanisms covering a wide spectrum of security levels.

**Indiana Cash Drawer Co.**

1315 S. Miller St.  
P.O. Box 236  
Shelbyville, IN 46176  
(317) 398-6643  
Key Personnel: Joseph R. Showers, Jr., Pres.; J.R. Showers, III, VP; Bruce L. Mann, GM

Indiana Cash Drawer Company makes a broad line of wooden or steel cash drawers, for over or undercounter installation, with manual or electronic controls (for use with business or personal computer). Manual model TD-1 has finderpull locking assembly with alarm that sounds if locking mechanism is improperly manipulated.

**International Door Closers, Inc.**

East: 1920 Air Lane Dr.  
Nashville, TN 37210  
(615) 885-7060  
(800) 225-6737  
FAX: (615) 885-0903  
West: 1140 North Kraemer Pl.  
Anaheim, CA 92806

(714) 666-0390  
(800) 544-4422  
FAX: (714) 666-2215  
Key Personnel: Kenneth T. Yamato, Pres.; Paul R. Linder, Sales/Mktg. Dir.

International Door Closers, Inc. has been manufacturing and distributing hydraulic Surface Mounted and Overhead Concealed door closers to the trade for nearly a quarter of a century from its distribution facilities in Anaheim, CA and Nashville, TN.

**Iseo Locks**

2121 W. 60th St.  
Hialeah, FL 33016  
(800) 421-ISEO (FL)  
(800) 443-ISEA (U.S.)

Iseo's manufacturing facilities in Italy produce some of the finest products in the world. We are proud of our Perfecta Bar that has 3" locking bolts that go into both sides of the door frame. Also a full line of brass padlocks with hardened steel shackle and all brass shackles.

**H.B. Ives**

62 Barnes Park North  
Wallingford, CT 06492  
(203) 294-4837  
Key Personnel: Sharon Berry, Jim Salonia

**Jackie's Junction**

P.O. Box 1368  
Sugarland, TX 77487  
(713) 568-0800  
Key Personnel: Walter Mendlovitz

**J & B Key-Rite Mfg.**

RD #1, Box 217  
Rockwood, PA 15557  
(814) 926-2176  
Key Personnel: William W. Gindlesperger, Pres.; Jean Gindlesperger, Sales

Key-Rite a portable electronic device powered by two AA batteries that enables you to adjust your key machine in seconds. Comes complete with two depth plates and easy to follow operating instructions, and a two year warranty. For under \$50.

**Jensen Tools Inc.**

7815 S. 46th St.  
Phoenix, AZ 85044  
(602) 968-6231  
Key Personnel: Sherman Jensen, Dev. Mgr.; Jean Hogg, Sales.

Jensen Tools Inc. is a manufacturer/distributor of tools and tool kits for the elec-

*Continued on page 46*



**Jensen Tools**  
*Continued from page 44*

tronics industry. Jensen products are used for installation and maintenance of computer, telecom and security systems (fiber optics and wire cable systems included). Write or call for a free catalog.

**Jet Hardware Mfg. Corp.**  
800 Hinsdale St.  
Brooklyn, NY 11207  
(718) 257-9600  
Key Personnel: Alfred Schonberger, Pres.; Fred Lang, VP; George Buchinger, Sec'y./Treas.

Manufacturer of high precision key blanks, tubular keys, Personaline, engraved key blanks, Squarousel key rack display, Keyboard display, key cutting machines.

**Glynn Johnson**  
4422 N. Ravenswood  
Chicago, IL 60640  
(312) 878-5500  
Key Personnel: Mike Riesen, GM/Pres.; Bob Brokamp, Sales Mgr.

Manufacturer of the finest quality builders hardware including overhead stops and holders; manual, automatic and constant latching flush bolts; coordinators; hospital push/pull and roller latches; pivot hinges; locking and non-locking surface bolts; floor and wall stops and holders; cabinet hardware and specialty items.

**JT Security Products**  
P.O. Box 368  
Temple City, CA 91780  
(818) 289-2559  
Key Personnel: James B. Thorp, Pres.

Products include builder hardware, business and technical aides, lock devices, locksmith supplies and tools and computer masterkey systems.

**Ke-Master**  
300 S. Pennell Rd.  
Media, PA 19063  
(215) 459-1129  
Key Personnel: T.L. Millar, Pres.; Peter Lindley, Nat'l Sales Mgr.

Ke-Master manufactures single tag and dual tag key cabinets and key control systems for organizing and securing from 20 to 800 keys. Also available are key tags, file drawer key racks and wall key boards.

**Keedex Manufacturing**  
12931 Shackelford Ln.  
Garden Grove, CA 92644  
(714) 636-5657  
Key Personnel: George Hill, Partner; Mike Hill, Partner; Julie McCluney, General Manager

Keedex Manufacturing produces a comprehensive line of locksmith tools and products. Keedex products include reinforcement plates for aluminum frame doors, safe lubricants, 12-volt motors, clip removal tools, followers and key control tags.

**The Kett Tool Co.**  
5055 Madison Rd.  
Cincinnati, OH 45227  
(513) 271-0333  
Key Personnel: H. Rowe Hoffman, Pres.; WM. A. Berlier, VP

Specialty cutting portable power saws, shears and nibblers for sheet metal, wood and plastics.

**Key Control Systems, Inc.**  
Box 96A, Weil Rd.  
Bechtelsville, PA 19505  
(215) 845-7585  
Key Personnel: S. Schwartz, Mgr.; Kate Bathurst, Nat'l Sales Mgr.; Nancy Brown, Adv. Coord.

*Continued on page 50*



**LOCKMASTERS  
SECURITY  
MANAGEMENT**

TM

*Click here  
for more  
information*

**Providing quality  
tools, parts, and  
service for  
the security  
professional.**



## Key Control Systems

*Continued from page 46*

Computerized key control system offers a simple, effective technique to maintain key identification, issue and return of data on a computer. Key cabinets, doorshields, keying charts, a controlled method for a master key system.

### Keymak Co.

430-B N. Lakeview Ave.  
Anaheim, CA 92807  
(714) 524-3350

Key Personnel: Devra Staneart, Office Mgr.; Linda Bedinger, General Mgr.

Keymak Code Key Cutters are portable, fast and require no electricity, making them the perfect tool for master-key systems, mobile trucks, and on-the-job keying. Two types available. The Keymak original serving two models: Schlage and Falcon I.C. (Best A2 and Arrow also) and the Keymaster, an interchangeable machine serving seven models with one base machine: Schlage, Falcon, I.C., Kwikset, Corbin, Weiser, Weslock, and Dexter.

### Keysure

P.O. Box 439, Prince Station  
New York, NY 10012-0008  
(212) 219-0015

Key Personnel: Len Siderl, CEO

Keysure, a plastic key control container, that protects keys individually. Signatures are required to make it work. Access to the key is not possible without breaking the container, indicating its use. Keysure is not reuseable. Keysure is available as a system for 100's of keys, and is available in blue and clear. Other uses: computer access codes/safe combinations etc.

### Kinduell Screen Products, Inc.

110 Center St. - Wilder  
Newport, KY 41071  
(606) 581-5444

Key Personnel: James R. Kinduell, Pres.; Bob Bramell, Sales Mgr.; Carole S. Kinduell, Comptroller.

Truck decals, vinyl pressure-sensitive pre-spaced lettering and standard in-stock logo's. Decals are durable, weather-resistant and easy-to-apply. Kinduell Screen Products, Inc. has been in the fleet marking business for over 30 years. Call or write for your free catalog today!

### Knight Safe Mfg. Corp.

13361 E. Molette  
Santa Fe Springs, CA 90670

(800) USA-BILT, (213) 921-9956

Key Personnel: Don Moore, GM; Bob Hogan, Nat'l. Sales Mgr.

Manufacturers of "B" and "C" rate, TL-15, TL 30 and TL-30 insulated money chests; Knight Watchmen floor safes; mercantile vault doors; bank equipment; two manufacturing plants, Santa Fe Springs, CA and Allentown, PA. Dealer sales only.

### Kustom Key

1010 Aviation Dr.  
Lake Havasu City, AZ 86403  
(602) 453-8338  
(800) 537-KEYS (5397)

Key Personnel: David Vedder, Pres.; Michael D. Vedder, Sales Mgr.

Kustom Key, Inc. has moved from Southern California to Arizona effective July 1st, 1987. From this new location we plan to continue our excellent service in supplying neuter bow key blanks, personalized blanks, and large bow hotel blanks. Look for new products to be available soon.

### Kwik Find Ltd.

25 Tiburon St.  
San Rafael, CA 94901  
(415) 459-2800

Key Personnel: Tony Orgell, Nat'l Sales Mgr.

Awake Alert, never fall asleep while driving again. Countdown Keychain, never get a parking ticket again. Beep 'n Keep Keyfinder, never lose your keys again.

### Kwikset Corp.

516 E. Santa Ana St.  
Anaheim, CA 92803  
(714) 535-8111

Key Personnel: John Lang, Pres.; Don Caldane, VP Sales; Wm. Tell Thomas, VP Mktg.

Manufacturer of locksets, leversets, handlesets, deadlocks and other home security products.

### Lab

P.O. Box 54  
Terryville, CT 06786  
(800) 243-8242

Key Personnel: R.A. Labbe, CEO; G.G. Roraback, VP; C.J. Kelly, Exec. VP Mktg.

Manufacture color coded replacement pins and original manufacturers pins, universal pin kits and original pin kits, locksmith picking instruments and professional tools.

### La Gard Inc.

3330 Kashiwa St.  
Torrance, CA 90505  
(213) 325-5670

Key Personnel: Nick Gartner, Pres.

### Latch-Gard Co.

P.O. Box 1285  
Elkhart, IN 46515  
(219) 293-9581

Key Personnel: Randall Moyer, Pres.; David Gelger, V.P.

Latch-Gard's new 3/8" cut out model is available for easy installation. Zinc or Duronodic finishes are available in both our standard or cut out models. Latch-Gard models come with special jamb pin to prevent prying of door. Latch-Gard covers the complete latch area to prevent latch tampering.

### LCN Closers

121 W. Railroad Ave.  
Princeton, IL 61356  
(815) 875-3311

Key Personnel: W.W. Martin, Mktg. Dir.; P.J. McCormick, Sales Mgr.

### LDM Enterprises

P.O. Box 191  
Van Nuys, CA 91408  
(818) 989-4100

### Learning Unlimited

P.O. Box 99038  
San Diego, CA 92109  
(619) 270-2371

Key Personnel: Carl Cloud, Owner

"Drill Points" are a set of scale size drill templates for seven of the most popular safe locks. Each template is double sided to show normal and an X-ray view for exact drilling locations. Included booklet, "How & Where," selects drill locations and opening procedures for each type of lockout.

### Lindustries Inc.

21 Shady Hill Rd.  
Weston, MA 02193  
(617) 237-8177

Key Personnel: Willard H. Lind, Pres.; Louise T. Lind, VP

Lindustries Inc. was founded in 1980 to consult with the hardware industry in the development, manufacture and marketing of new fasteners, lock mechanisms and security devices. Among these devices is Leveron, which changes all standard door knobs to lever handle action without removing in-place hardware.



#### Lock Technology Corp.

685 Main St.  
New Rochelle, NY 10801  
(914) 632-4373  
Key Personnel: Jack Morris, Plant Mgr.

High security (Medeco) Ignition locks for American cars, KM-3 code key machine, KMV-1 key machine (Kaba, Mercedes, etc.), locksmith tools, research and development.

#### Locknetics Security Engineering

560 Birch St., P.O. Box 9337  
Forestville, CT 06010  
(203) 584-9158  
Key Personnel: Steve Kamen; Joel Fastow

With over 33 years experience, Locknetics Security Engineering has become the best—by doing more. Not only do our products conform to the most demanding codes, they're all tested and inspected—to meet our stringent quality standards. Manufacturers of the Intel, electromagnetic locks, electric deadbolt locks, and power supplies and station controls.

#### Lori Lock

Old Tumpike Rd.  
Southington, CT 06489  
(203) 621-3601  
Key Personnel: Dave Florian, Pres.; George N. Nortonen, VP Bus. Development; Andrew J. Meade, VP Sales

Manufacturers of solid brass mortise and insert cylinder solid brass decorative door hardware, mortise cylinder deadlocks, jimmy proof deadlocks, super blocker and cylinder guards, mailbox locks, rim cylinders, and Kaba high security locks.

#### The Lost Key Co., Inc.

5543 E. Lake Rd.  
Sheffield Lake, OH 44054  
(800) 826-5541 (OH),  
(800) 826-5458  
Key Personnel: William M. Lewis, Pres.

\$50.00 reward tags for returning briefcases to computer disc pacs. \$5.00 reward tags for keys and lower priced items. Key and message center - a key and message organizer for promotions, Secur-A-Center - a storage device for storing file keys passively.

#### Lucky Line Products, Inc.

7890 Dunbrook Rd.  
San Diego, CA 92126  
(619) 549-6699 (CA), (800) 654-6409 (Natl.)  
Key Personnel: Ray Howard, Pres.; Greg Howard, VP; Diane Cross, Cust. Svc.

Lucky Line Products, Inc. is a leading supplier of popular key rings and key accessories. Included in their product line are the Twisty, Fix-O-Loc Secure-A-Key and I.D. key tags.

#### Lund Equipment

P.O. Box 213  
Bath, OH 44210  
(216) 659-4800  
(216) 659-4128  
Key Personnel: E. Howard Lund

#### M.A.G. Eng. & Mfg. Co. Inc.

15261 Transistor Ln.  
Huntington Beach, CA 92649  
(714) 891-5100  
FAX: (714) 892-6845  
Key Personnel: Howard M. Allenbaugh, Pres.; Fred F. Pannebaker, Sales Mgr.; Diane E. Stevens, Sales Coord.; Barry Coffman

MAG security products enable you to repair and reinforce doors instead of replacing them. You'll save money and time, while improving door strength and appearance. The Install-A-Lock mounts the lockset and latch into one solid unit which makes the door as strong as the lock.

#### Magnum Mfg. Co.

HC-75, Box 2482 Rustler Trail  
P.O. Box 2082  
Camp Verde, AZ 86322  
(602) 567-6222  
Key Personnel: William Nowman, Owner; Esther Nowman, Owner  
Magnum Mfg. Co. manufactures the 357 Magnum Safe Drill and accessories. Magnum serrated carbide tip drill bits, the Diamond Carbide Cutter drill bit (Diamatip) and other tools for the safe and vault trade.

#### Major Manufacturing

1825 Via Burton  
Anaheim, CA 93806  
(714) 991-4666, (213) 979-3402  
Key Personnel: W.E. DeForrest, Sr., Pres.; Bill DeForrest, Jr., VP/GM; Linda DeForrest, Controller.

#### Major MetalFab Co.

370 Alice St.  
Wheeling, IL 60090  
(312) 537-7890  
(800) 323-8181  
Key Personnel: Jon Swirsley, Prod. Mgr.; Rob Fosness, Dir. of Mktg.  
MMF Industries manufactures a full line of key control products. Single tag and two tag systems are available in cabinet, drawer, key rack and key board styles. Key capacities range from

10 to 715 keys. In addition, MMF manufactures coin and cash handling supplies, signs and writing instruments.

#### Markar Products, Inc.

12715 Lewis Rd.  
Akron, NY 14001  
(716) 542-3001  
Key Personnel: Ladonna Bennett, Pres./Owner; Stanley R. Tatara, VP

Markar Products, Inc., manufacturers of the patented reinforcing pivot, aluminum continuous hinges and fire-rated steel and stainless steel continuous hinges. Both pivots and continuous hinges are used in contract, retrofit, hospital, school and security applications.

#### Marks Hardware, Inc.

10 Commercial St.  
Hicksville, NY 11801  
(516) 938-5800  
Key Personnel: George Marks, Pres.; Sheila Rosenberg, Natl. Sales Mgr.

Manufacturer of designer series decorative mortise and tubular locksets, cylindrical locksets, commercial and residential mortise and tubular locksets, deadlocks, gate locks, mortise locks for ornamental iron doors.

#### The Martin Company

P.O. Box 813, Postal Station A  
Hamilton Ontario  
Canada L8N 3M8  
(416) 523-7246

#### Martin, Starchuk & Szostak

P.O. Box 3278, Postal Station C  
Hamilton, Ontario, Canada  
L8H 7L8  
(416) 523-6722  
Key Personnel: Wm. Starchuk, Co-owner

We produce and distribute Impressioning tools which use replaceable adhesive falls.

#### Master Lock Co.

2600 N. 32 St.  
Milwaukee, WI 53210  
(414) 444-2800  
Key Personnel: George Villwock, Pres.; Peter Jung, VP Sales/Mktg.

Master-keyed padlock systems. Rekeyable lock systems. Reserved keyway option. Wide selection of steel and brass laminated locks, solid body locks, combination locks, locker locks Locksmith padlock replinning and serving kits. Specialty locks for sports and recreation equipment.



**Lloyd Matheson,  
Inc./Lockwood**

P.O. Box "L"  
Charlestown, NH 03603  
(603) 826-5777

Key Personnel: Lloyd J. Matheson, Sr.,  
Pres.; Alex Matheson, VP; David B.  
Colburn, GM.

Lloyd Matheson, Inc./Lockwood is a  
manufacturer of mortise locksets, lever  
handle cylindrical locksets, removable  
cores, Lockwood master key systems,  
exit devices, tubular and mortise dead-  
bolts, asylum locks and knob mortise  
latch. The Lockwood tradition of fine

architectural hardware for over 100  
years continues at Lloyd Matheson Inc.

**McGunn Safe Co.**

6401 W. 65th St.  
Chicago, IL 60638  
(312) 458-8883

Key Personnel: Edward T. McGunn,  
Edward J. McGunn, Donna M.  
Costello

McGunn Safe Co. with manufacturing  
plants based in Korea is now wholesal-  
ing over 62 different models including  
floor safes, fire safe, depository safes,  
and high security units for cash or  
valuables.

**MDS, Inc.**

P.O. Box 17326/Airport Station  
Clearwater, FL 33622  
(813) 577-6339

Key Personnel: F. Paul Butler, Pres.

Medical Diagnostic Services, Inc. is now  
celebrating its tenth year in the security  
industry as manufacturers of the Focu-  
scope™ modular borescope system,  
Probe Lite™ flexible inspection light,  
Magnascope™, otoscope/ophthalmo-  
scope system and other inexpensive  
diagnostic tools for the locksmith/  
safeman.

**Medeco Security Locks, Inc.**

P.O. Box 3075  
Salem, VA 24153  
(703) 380-5000

Key Personnel: Tim Layton, Pres.:

Medeco Security Locks, Inc. manufac-  
tures high security locks and lock  
cylinders. The Blaxial lock design offers  
key control, masterkeying, pick and drill  
resistance, and is UL listed and pat-  
ented. Medeco offers locks to a wide  
variety of industries, including institu-  
tions, residential, business, and OEM  
applications.

**Mellink Safe Co.**

6245 Industrial Pkwy.  
Whitehouse, OH 43571  
(419) 877-5352

Key Personnel: James Akers, Pres.

Supplier of complete line of home safes,  
record safes, data safes, money chests,  
insulated files and insulated vault doors.  
Prompt quotation and delivery on cus-  
tom money chests.

**Meister Atlanta Corp.**

3673 Clairmont Rd.  
Atlanta, GA 30341  
(404) 451-9700

Key Personnel: Harry Detlefs, Pres.;  
Renate Detlefs, Sec'y.

Heavy duty strike plates H1280 and  
2000.

**Merit Metal Products Corp.**

242 Valley Rd.  
Warrington, PA 18976  
(215) 343-2500

Key Personnel: Len Wolberg,  
Chmn. of Bd.

We are manufacturers of brass re-  
placement cylinders, mortise and rim.  
We also manufacture specialty locks  
such as gate locks and sliding or pocket  
door locks. Finally, we make a full line of  
solid brass decorative hardware for  
windows and doors including hinges,  
door stops, etc.



**Major**  
MANUFACTURING, INC.

**Every Installation  
Is a Self-Portrait  
Of the Person Who Did It.  
Autograph Your Work  
with Excellence.**

[Click here for more information](#)



**Metal Building Technologies**

P.O. Box 10952, #108  
Houston, TX 77292  
(713) 683-6859

Key Personnel: Steve Ruiz, General  
Mgr.; Irene Ruiz, Bookkeeping;  
Deneen Harrison, Sales

MBT is the inventor of the Lockguard  
plate for aluminum store door fronts. It is  
easy to install and all hardware is  
included. Please call 713-683-6859 for  
brochure and price or order forms.  
Quantity price discounts are available  
for suppliers. Our plates come in black  
and gray color.

**Metal Products Engineering, Inc.**

3864 Santa Fe Ave.  
Los Angeles, CA 90058  
(800) 824-0222, (213) 581-8121 (CA)  
Key Personnel: L.R. Luppen, Pres.

Manufacturer of MP Key Chests (Key  
storage cabinets.) Item 3450-030, 30  
key capacity; Item 3450-040, 40 key  
capacity; item 3450-060, 60 key capac-  
ity; item 3450-080, 80 key capacity.

**H.E. Mitchell**

118 S.E. 8th Ave.  
Portland, OR 97214  
(503) 236-9444

Key Personnel: R.L. Messing

**MIWA**

1415 N.E. 123rd St.  
Seattle, WA 98125  
(206) 367-4100

**M.L. Lock & Safe Co.**

21 N. Beverwyck Rd.  
Lake Hiawatha, NJ 07034  
(201) 263-3953

Key Personnel: Jeff Hale, Pres.; Larry  
Hale, VP; Joe Allen, Sec./Treas.

Manufacturers of affordable cash han-  
dling containers for the temporary stor-  
age of cash. Three models currently  
manufactured, along with two new  
models of "Econovault" designed to be  
used as a lockable container, secured  
in any location, where temporary stor-  
age of small valuables, or weapons is  
required.

**Monarch Hardware & Mfg. Co.**

P.O. Box 548  
Shepherdsville, KY 40165  
(502) 543-2281

**Moore Technology**

656 Chapelgate Dr.  
Odeton, MD 21113  
(301) 787-7211

**Moose Products Inc.**

P.O. Box 2904, 1510 Tate Blvd., S.E.  
Hickory, NC 28603  
(704) 322-2333

Key Personnel: John Setzler, Scott  
Becker

**Mosler**

1561 Grand Blvd.  
Hamilton, OH 45012  
(513) 870-1136

Key Personnel: R.F. Murphy,  
President; N. Pearce, Mktg. Comm.,  
A.M. Marzano, Sr. V.P., Inst./Svc.

**MRL, Inc.**

7644 Fullerton Rd.  
Springfield, VA 22153  
(703) 569-0195

Key Personnel: C.S. Moorefield,  
Chairman of the Board; Carlton Moore-  
field, Jr., Pres.; John Aguinado, Prod.  
Mgr.

Manufacturer of quality electronic  
security and access control systems  
since 1969. Products include: Crypto  
Code/MAC systems stand-alone digital  
and card access control systems; Entro-  
dyne DIAM 50-3 line supervising equip-

*Continued on next page*

**medeco**<sup>®</sup>  
HIGH SECURITY LOCKS

*Integrity.  
Ingenuity....  
security solutions.*

[Click here for more information](#)



**MRL, Inc.**

*Continued from previous page*

ment; Yard Light PIR light controls; SoundAlert audio discriminatorsystems; R.F. transmitters and receivers; simulated cameras.

**Mul-T-Bolt Corp.**

54-45 44th St.  
Maspeth, NY 11378  
(800) 622-5625, (718) 392-9000  
Key Personnel: Mark Berger, Nat'l. Sales Mgr.

A Division of Securitech Group, Inc., Mul-T-Bolt Corp. manufactures 100% American made 4-point doorlocking systems. Recently introduced the lock industry's first security exit device, the Series 8000 panic exit deadlock system, all bolt, no latch. Listed by UL.

**Multi-Lock, Inc.**

2027 Harpers Way  
Torrance, CA 90501  
(213) 320-6400

**Mul-T-Lock Corp.**

54-45 44th St.  
Maspeth, NY 11378  
(800) 622-LOCK, (718) 392-9000  
Key Personnel: Mark Berger, Nat'l. Sales Mgr.

Manufacturer of multiple-point locking systems with standard keyways or Medeco cylinders, 100% made in U.S.A. UL listed. New model 4100 requires no special tools for 2 3/4" backset installation in hollow metal doors. Security locks for security professionals.

**Murphy Hinge Co.**

641 Center Ave.  
Mamaroneck, NY 10543  
(800) 645-7455, (914) 698-4811  
Key Personnel: Ray Plunkett, Sales Mgr.

The original replacement hinge for aluminum store doors. Easy and fast installations, high profits.

**Mutual Screw & Supply**

68 W. Passaic St.  
Rochelle Park, NJ 07662  
(201) 845-5700, (800) 222-0324  
Key Personnel: Herb Migdal, Pres.; Mark Warner, VP; Robert Garfinkel, Nat'l. Sales Mgr.

We are a full line distributor of packaged and bulk fasteners, nuts, bolts, screws, washers, etc. with particular emphasis on security screws, in steel and stainless steel.

**National Cabinet Lock**

200 Old Mill Rd.  
P.O. Box 200  
Mauldin, SC 29662  
(803) 297-6655  
Key Personnel: Dave Bowers, VP/GM; Don Bjork, Dir. Sales/Mktg.; Larry Roddy, Prod. Mgr.

Under the Stock Locks trade name, National Cabinet Lock offers from its product line a selection of over 600 packaged stocking units for retail sales through locksmiths.

**National Control Systems**

15725 West Ryerson Rd.  
New Berlin, WI 53151  
(414) 784-5151  
Key Personnel: Dale S. Duda, VP Sales & Mktg.; Robert V. Demson, Nat'l. Sales Mgr.

The NCS Mini AT System is a stand alone, intelligent access control and alarm monitoring system. Intelligent Reader stores up to 4000 cardholders and contains 8 binary input and 4 outputs. One to 99 intelligent readers can be supported on one communication loop. UL listed reader supports four card technologies.

**The National Locksmith**

1533 Burgundy Pkwy.  
Streamwood, IL 60107  
(312) 837-2044  
FAX: (312) 837-1210  
Key Personnel: Marc Goldberg, Editor/Publisher; Tom Miodoch, Ad Sales Manager; Barbara Coulam, Circulation Manager.

Publishers of the locksmith's favorite magazine, code book, and technical manuals.

**National Security Safe Co.**

P.O. Box 1431  
Orem, UT 84059  
(801) 226-0245  
Key Personnel: Glen Nilson, Walt Crosby

**Nel-Tech, Inc.**

10831 SW Cascade Blvd.  
Portland, OR 97223  
(503) 620-8540,  
(800) 547-6954 (Nat'l.)

Nel-Tech manufactures a line of durable control panels for residential and commercial sites. In addition, they provide interfacing programmable remote keypads, decoders, shunt switches and assorted accessories. Nel-Tech also designs custom keypads with various finishes and button colors.

**NKL Safe Co.**

1111 Cavalier Blvd.  
Chesapeake, VA 23323  
(804) 485-0200 (VA),  
(800) 528-9900  
Key Personnel: Wanda Lee Smith, GM; Mike Smith, VP Sales

Manufacturer of commercial and residential burglar resistant safes and drive-thru window security bars. Providing a full line of money, wall, vehicle, in-floor and roll depository safes carefully designed to meet the needs of both a wide variety of businesses and the homeowner. Specialists in custom designed security products.

**Noblit Industries, Inc.**

2055 Richmond St.  
Philadelphia, PA 19125-4382  
(215) 634-7700, (800) 458-7873  
FAX: (215) 634-7700  
Key Personnel: Mo Meidar, Pres.; Alex Ebel, VP/General Mgr.; David Dear-dorff, VP/Sales & Mktg.

Since 1849, Noblit has held a niche in the standard hardware market. In 1985, under new ownership, Noblit evolved into a manufacturer of premium door products for the retail, contract and OEM trade. Today, Noblit produces residential, commercial and architectural grades of security and builders' hardware.

**Normbau Inc.**

1040 Westgate Dr., P.O. Box 979  
Addison, IL 60101  
(312) 628-8373  
Key Personnel: Rik Lecot

**Ohio Traveling Bag Mfg. Co.**

811 Prospect Ave.  
Cleveland, OH 44115  
(216) 621-5963

**Omni Concepts**

1150 N. First St., Suite 220  
San Jose, CA 95112  
(408) 246-OMNI  
Key Personnel: Robin Liston, Nat'l. Mktg. Dir.; Gregg Allington, No. Calif. Master Distributor; C. Jett Winter, C.E.O.

The Omni-Guard is a forced entry deterrent for in-swinging doors. Two interlocking steel plates tie door and jamb together to protect locking systems from burglars and trespassers. Prying tools, slide cards, and jamb spreading devices cannot penetrate the Omni-Guard barrier. Omni-Guard is UL listed and Wamock Hersey fire-rated.



**Omnia Industries, Inc.**  
P.O. Box 330  
Cedar Grove, NJ 07009-0330  
(201) 239-7272

Key Personnel: Alberto R. Comini,  
Pres.; Fred Marzullo, Prod. Mgr.; Bar-  
bara E. McGrath, Mktg. Mgr.

Omnia manufactures solid brass  
builders' hardware since 1964. The  
company offers entry sets, interior  
latch sets, narrow stile mortise locks with  
trim, cremone bolts, surface bolts,  
door stops, door knockers, switch-  
plates, house numbers, cabinet hard-  
ware and bath accessories.

#### **Pacific Security Products**

307 S. Raymond Ave.  
Alhambra, CA 91803  
(800) 331-0785 or  
(818) 570-4655

Key Personnel: Denise E. Ambrose,  
Pres.; John Stahl, VP; Dan Prestler,  
Manager

Manufacturer of fire safes, floor safes "C"  
and "B" rate chests, rotary hoppers and  
convenience store safes our specialty.  
Special quotes accepted.

**PDQ Industries Inc.**  
208 E. Main St.  
Brownstown, PA 17508

(717) 656-4281, (800) 441-9692  
Key Personnel: Edward B. Linaugh, VP  
Sales; Joseph Ghergo, Nat'l. Sales  
Mgr.

Offer complete line of cylindrical, mor-  
tise and residential tubular locks in most  
popular designs, finishes and keyways.  
Products are UL listed and comply with  
ANSI. Keyways available include:  
Arrow, Corbin, Russwin, Schlage, and  
Sargent. Masterkeyed jobs delivered  
within three weeks; most stock orders  
delivered within one week.

**Peerless Sales Co.**  
1950 Hawthorne Ave.  
Melrose Park, IL 60160  
(312) 865-8870

Key Personnel: Walter Griffing,  
Pres.; Walter Snodell, VP Sales; Art  
Mraz, Sales Mgr.

Peerless manufactures the world's  
largest and most complete line of tele-  
vision, audio visual, video recorder and  
closed circuit television accessory pro-  
ducts. The many products include  
security fasteners, security hardware,  
stands, mounts, carts and brackets for  
the desk, wall and ceiling.

**The Penetrator**  
7211 Windover Way  
Titusville, FL 32780  
(305) 267-0700

Key Personnel: Lew F. Noyes Jr. CPL,  
Eleanor M. Noyes, Owners.

The Penetrator is a safe drill-rig. Its fea-  
tures are light weight, controlled drilling  
and a thrust bearing which relieves all  
pressure from your drill motor which will  
prolong its life. A new Penetrator, PDR-4  
has just been introduced. With it, you  
pull instead of push your drill motor.

#### **Perma Vault/Bonafide Factory Prod.**

P.O. Box 473  
Huntingdon Valley, PA 19006  
(215) 364-0330

Key Personnel: Marvin Sabel, Pres.;  
Irving L. Plaksin, Exec. VP.

Perma Vault cash protection units, in  
room safe deposit boxes, in wall safes,  
hopper safes.

**The Peterzell Co.**  
P.O. Box 521357  
Longwood, FL 32752-1357  
(407) 830-1171

*Continued on next page*

# NATIONAL AUTO LOCK SERVICE, INC.

**National Auto Lock Service, Inc. offers a wide  
range of equipment and services for the  
Automotive Locksmith. From tools and hard to  
find key blanks to transponder  
programming, we can take the mystery out of car  
service. We accept credit card orders, and can ship  
COD. Contact us for the latest in  
automotive technology.**

[www.laserkey.com](http://www.laserkey.com)



**The Peterzell Co.**

*Continued from previous page*

Key Personnel: Victor Peterzell, Pres.; Betty Eichelberger, Office Mgr.; Abe Peterzell, Sec'y.

Personal protection devices, battery operated door and window alarms, key accessories, door viewers and door knockerviewers, doorannunciators, low cost home burglar alarm systems.

**Phoenix Industries Inc.**

P.O. Box 38  
Linwood, KS 66052  
(913) 723-3203  
Key Personnel: Jeff Coatney

**Preso-Matic Lock Co., Inc.**

3048 Industrial 33rd St.  
Fort Pierce, FL 34946-8694  
(305) 465-7400  
Key Personnel: Albert C. Sanowskis, Pres.; Mary Ann Sanowskis, Sec'y./Treas.

Preso-Matic pushbutton combination door locks are mechanically operated. Four digit combination locks have 10,000 possible combinations; seven digit locks have 10,000,000. PM locks can be mastered with six digit masters. Double combination locks operate by combination on both sides of lock. New narrow style lock for narrow style glass doors.

**Presto Lock, Inc.**

100 Outwater Lane  
Garfield, NJ 07026  
(201) 340-1000  
Key Personnel: J. Orabona, Pres.; Carl Mann, VP Sales.

Combination locks and deadbolts. All are resettable without the need for a coin or special tool. Changable cylinder padlock with interchangeable shackles.

**Pro-Lok**

2760 S. Harbor Suite H  
Santa Ana, CA 92704  
(714) 641-1249  
Key Personnel: Adam Weinraub

**Racal-Chubb/PGI**

P.O. Box 1505  
Palm Harbor, FL 34682  
(813) 785-0642  
Key Personnel: James R. Ringold, Pres.

Racal-Chubb is a full line supplier of UL listed products including class 2 Instavaults®, Class 1, 2, and 3 vault doors, TL-15, TL-30, TRTL-30 and TRTL-30X6 safes. Also available are night depositories, safe deposit boxes, and access control systems.

**R & D Tool Co.**

3107 Eubank N.E., Suite 11-B  
Albuquerque, NM 87111  
(505) 294-1820  
Key Personnel: Douglas W. Joosten, RL, Pres.; Ruth Joosten, Sec'y./Treas.

We have been in business over two years manufacturing and selling the GM pickset. It will pick and decode all GM side-bar locks. We now have a patent on the pickset.

**Reading Body Works**

P.O. Box 14  
Reading, PA 19603  
(215) 775-3301

**Redi-Line Generators**

4301 Kishwaukee St.  
Rockford, IL 61109  
(815) 226-3030  
Key Personnel: Michael B. Mungor, Product Mgr.

**Rixson-Firemark, Inc.**

9100 W. Belmont Ave.  
Franklin Park, IL 60131  
(312) 671-5670  
Key Personnel: Robert C. Spargo, AHC-VP Mktg.

**Rofu International Corp.**

3725 Old Conejo Rd.  
Newbury Park, CA 91320  
(805) 499-0316  
Key Personnel: Len Guyt, VP

Rofu International Corporation stocks for immediate delivery a wide selection of electric strikes, high security electric strikes, electromagnetic locks, switches, lockshields, keyless access control systems and installation hardware.

**Roton Corporation**

1115 N. Ellsworth  
Villa Park, IL 60181  
(312) 941-0900  
Key Personnel: Austin R. Baer, Pres.

Roton Corporation manufactures patented, continuous gear hinges which are applied to the full height of door and frame. Made of extruded aluminum alloy, Roton hinges are used in contract, retrofit, school, hospital and security applications for high-frequency doors with weights up to 1000 lbs. supported on shock absorbent, molded bearings.

**Rytan, Inc.**

2908 Oregon Ct., Bldg. 1-5  
Torrance, CA 90503  
(213) 775-8007, (213) 328-6553,  
(800) 841-3919 (CA),  
(800) 44RYTAN (Nat'l.)

Key Personnel: Mike Sopko, Pres.; Carol Silbaugh, Mktg.; Sam Sopko, Technical Support

Key manufacturing, lock picks and tools.

**Sabir Lock Inc.**

10241 Norris Ave.  
Pacifica, CA 91331  
(213) 875-0266  
Key Personnel: R.L. Day, Pres.; Haleema Sabir, Exec. VP; John Millan, Dir. of Mktg.

The Sabir Personal Security Apartment Deadbolt is built and tested to exceed the maximum requirements of the Uniform Building Security Code. The lock derives its strength from the main wall stud through six heavy-duty wood screws and a heat treated high carbon steel locking mechanism.

**Sandstrom Products Co.**

224 Main Street (Ship)  
P.O. Box 547 (Mail)  
Port Byron, IL 61275  
(309) 523-2121, (800) 747-1084  
FAX: (309) 523-3912  
Key Personnel: James P. Sandstrom, Pres.; Rick J. Hartscock, VP of Mktg.; Pat Morthland, Lubricant Division Mgr.

Sandstrom lubricants are low friction, lacquer-like products containing fluorocarbon, molybdenum disulfide and/or graphite pigments. They are designed to prevent corrosion, galling, seizing and fretting.

**Sargent & Greenleaf, Inc.**

One Security Drive  
Nicholasville, KY 40356-0569  
(606) 885-9411  
Key Personnel: Gary Kepler, Cus. Svc. Mgr.; Ned Urschel, Director of Sales; Gary Murphree, Dir. New Product Development.

Sargent & Greenleaf manufactures Group I and II UL listed combination locks, vault locks, high security key and combination padlocks which meet military and government specifications. Additional products: environmental padlocks, safe deposit locks, hinges and safe handles.

**Sargent Manufacturing Co.**

100 Sargent Dr.  
New Haven, CT 06511  
(203) 562-2151  
Sargent offers a variety of door hardware to the locksmith including mortise and bored locks, auxiliary locks, door closers and exit devices.



**Schlage Lock Co.**

2401 Bayshore Blvd.  
San Francisco, CA 94134  
(415) 467-1100

Key Personnel: Jerry Tuff, Pres., Lock Div.; John Gamble, Mgr. Mktg/Sales; Peter Arezzini, Commercial Mktg. Mgr.

The Schlage Lock Company is a leading manufacturer of security products. From mechanical to electronic security systems, Schlage products are backed by a 60 year reputation for quality. Through locksmith supply channels, Schlage products are distributed nationally.

**Schlage Electronics**

2401 Bayshore Blvd.  
San Francisco, CA 94134  
(415) 467-1100  
FAX: (415) 330-5530

Key Personnel: Patrick Murphy, Greg Markes

**Schwab Safe Co., Inc.**

3000 Main St.  
Lafayette, IN 47903-5085  
(317) 447-9470

Key Personnel: Peter Neisel, Pres.; Charles Marquardt, VP Sales/Mktg.

Schwab manufactures a complete line of UL rated fire resistant insulated safes, files and vault doors. These products are designed to protect paper, microforms, and magnetic media from loss during a fire. All Schwab products feature customized interiors designed to meet the user's special storage and protection requirements.

**Scotsman Security Products Inc.**

P.O. Box 1250  
Pine Grove, CA 95665  
(209) 296-7777, (800) 321-GARD  
Key Personnel: Robert R. Irmer, Pres./ Sales Mgr.; Elmagene Irmer, Sec-Treas/Mktg. Mgr.; William R. Irmer, VP/Mfg. Mgr.; Maria Irmer, VP/AP Mgr.

For 18 years, Scotsman has been developing and manufacturing with pride the highest quality products for the locksmith and builders hardware industries. Choice of tubular key machines: 747E, 747X and 747XU. Full line of narrow-stile aluminum store front high security protection: DorGard I, DorGard II, DorGard III, DorGard IV, DorGard V. New product: protective cylinder ring, Cylgard.

**Sealeze Corp.**

8013 Whitebark Terrace  
Richmond, VA 23237  
(800) 446-7325  
FAX: (804) 743-0051

Key Personnel: Jonathan Pelly-Fry, Executive VP; Deborah New Lowry, VP, Finance; Helen Lewis, VP, Sales

As the originator of brush steel technology, Sealeze Corp. carries a full line of gasketing and thresholds to complement any door package. Sealeze also manufactures high-quality seals for commercial and residential applications.

**Secur-A-Door Lock**

Door Lock Co., Inc.  
P.O. Box 881  
Smithtown, NY 11787  
(800) 233-5625

Key Personnel: Pete Narden

A permanently affixed locking device for steel buck doors.

**Securitech Group Inc.**

54-45 44th St.  
Maspeth, NY 11378  
(800) 622-LOCK, (718) 392-9000  
Key Personnel: Mark Berger, Nat'l. Sales Mgr.; Denise Vargas, Locksmith Sales Coord.

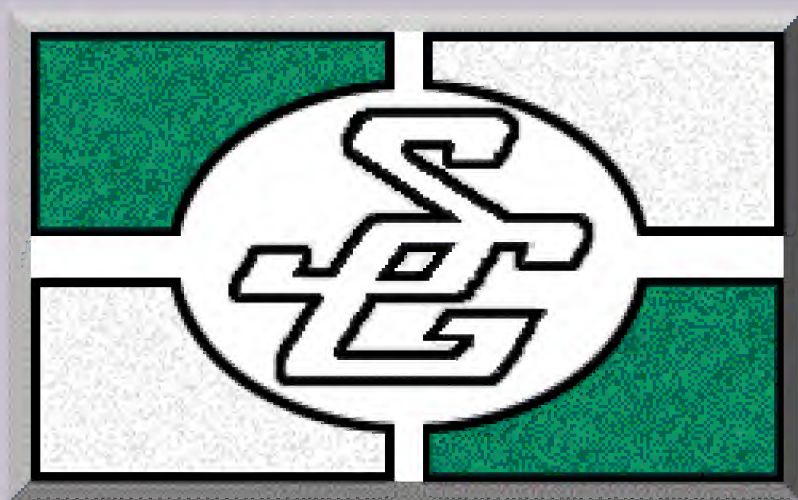

***Choose S&G Comptronic  
electronic safe locks for...security...  
technology...tradition.***

[Click here for more information](#)



100% American manufacturer of locksmith-only high security deadbolts, automatic and multiple point locking systems. Featuring Double-Throw 2-inch deadbolt top rated by consumer reports and the new 1derbolt, 1½" throw deadlock. New panic exit deadlock system is the first 4 deadbolt UL listed exit device. Security locks for security professionals.

#### Securitron

1815 W. 205th St. Ste. 103  
Torrance, CA 90501  
(213) 618-0204

Key Personnel: Bob Cook, Pres.; Vince Fratlicciardi, VP; Scott Baker Nat'l. Sales Mgr.; Fred Barton, Advertising and Public Relations

Manufacturers of the Magnalock, the rust proof magnetic lock with the stainless steel case; the DK-20 digital keypad, weatherproof with the versatility to interface with any electric lock; the revolutionary Touch-Sense Bar exit device; power supplies; electric key switch panels; timers; and custom control systems.

#### Security Door Controls

31280 La Baya Dr.  
Westlake Village, CA 91360  
(818) 889-1622

Key Personnel: Dave Geringer, VP Sales; Rick Geringer, VP Tech. Svc.; Gary Thornberg, Cust. Svc.

For 15 years SDC has been manufacturing electric locks for the locksmith industry. Included in the SDC product line are electromagnetic locks, electric bolt locks, electric strikes, power supplies with battery back-up capabilities and a full line of switch control accessories.

#### Security Latch

12229 M-89,  
Plainwell, MI 49080  
(616) 629-4981

Key Personnel: Robert Vanderboegh

#### The Security People

703 Market St.  
San Francisco, CA 94103  
(415) 777-2404

Key Personnel: Bill Gordon, Pres.; Bill Reagan, VP Prod. Dev.; Brigitte Peterson, Acctg.

The Security People have been specializing in masterkey and key control systems since 1981 and are now manufacturing computer software for the security industry. LOCKUP, a computer program for key control that keeps track of all lock and key inventory, is being used by hospitals, colleges, hotels and office buildings.

#### Sensalight Corp.

4750 Cromwell  
Memphis, TN 38118

(901) 363-1308

Key Personnel: Stephen G. Olita, Pres.

Sensalight Corporation manufactures "Sensalight" an ultrasonic light switch to help improve home security. The device takes the place of the existing on-off porch light switch and provides one minute of lighted entry when activated by the jingling of keys. No ambient sounds activate the device, only keys from 40 feet.

#### Sentrol Inc.

10831 SW Cascade Blvd.  
Portland, OR 97223  
(503) 620-8540 (800) 547-2556, (800) 253-5600 (Canada)

#### Sentry Group

900 Linden Ave.  
Rochester, NY 14625  
(716) 381-4900

Key Personnel: Jack Brush, Chmn.; Dick Brush, Pres.; Doug Brush, Exec. VP.

Sentry Group manufactures a complete line of Sentry Supreme security products and UL rated fire safes for office and home use. Sentry Supreme safes come in a variety of sizes for various protection needs. Sentry Supreme offers a 3-year warranty and a 10-year after fire replacement guarantee on all fire safe models.



# SCHWAB CORP.

*Fire protection for your vital records.*

**Free freight!!**  
**No middle man!!**

[Click here for more information](#)



**Serr-Edge Machine Co., Inc.**  
4471 W. 160th St.  
Cleveland, OH 44135  
(800) 443-8097, (216) 267-6333  
Key Personnel: Linda Ribar  
Oakley, Office Mgr.

Serr-Edge, the manufacturer of the East-sharp Scissor Sharpener since 1940, believes that locksmiths can earn additional profits and add customers by having a scissor sharpening service. Since it only takes a minute to sharpen a pair of shears, the shop operator can also earn a good profit.

**Sidro Security Products**

P.O. Box 9725  
New Haven, CT 06536  
(800) 233-0478  
Key Personnel: Jeffrey S. Addis, Nat'l. Sales Mgr.; Leslie J. Saunders, Cust. Svc. Coord.

In addition to alarmed exit hardware, Sidro offers both conventional and touch bar exit devices in rim, vertical rod and mortise types. Most products are available through Sidro's Fast Shipping Service.

**Sieveking Products Co.**

P.O. Box 4287  
Rockford, IL 61110  
(815) 874-4030  
Key Personnel: Bob Sieveking, Owner; Jane Sieveking, Mgr.

Manufacturers of Squeeze-Play™, Clamp-King™, Door Core™, E-Z Pull™. Locksmithing tools for the professional locksmith.

**Silca SPA**

Via Podgora, 20 (Z.I.)  
31029 Vittorio Veneto TV (Italy)  
(0438) 50 13 43  
50 00 46

**Simplex Security Systems**

Front & Main Sts.  
Collinsville, CT 06022  
(203) 693-8391  
Key Personnel: Dave Creedon, Pres.; Tom Nazziola, Sales Mgr.

Pushbutton combination locking devices with easily changeable codes and completely mechanical in operation for various door cabinet and access control applications.

**Slide Lock Tool Co.**

P.O. Box 386  
Louisville, TN 37777  
Key Personnel: Elaine Selby, Owner; Douglas Selby, Sales Mgr.; Lorraine Selby, Wholesale Mgr.

A lockout tool designed to unlock all "20" GM models equipped with the horizontal slide-lock systems.

**Southern State Technology**

P.O. Box 5739  
Hollywood, FL 33083-5739  
(305) 989-7735  
Key Personnel: Don Barraclough

**S. Parker Hardware Mfg. Corp.**

Parker Dr.  
P.O. Box 9882  
Englewood, NJ 07631  
(201) 569-1600

**Stanley Hardware**

195 Lake Street  
New Britain, CT 06050  
(203) 225-5111  
Key Personnel: David Loughran, Marketing; James A. Stevens, V.P. Sales  
The Nation's oldest hinge manufacturer.

**Star Key & Lock Mfg. Co., Inc.**

1274 Flushing Ave.  
Brooklyn, NY 11237  
(718) 821-8300  
Key Personnel: Herbert G. Stein, Pres.; Lorraine G. Stein, Exhibit Director; Harry Stein, Sec'y./Treas.

Star Key is proud to announce a new, revised edition of the company's popular Key Blank Comparative List, including all of the "Latest Star Additions" to date with the conversion numbers for Ilco, National/Curtis, Taylor and Make of Lock.

**Steck Manufacturing Co., Inc.**

1115 South Broadway  
Dayton, FL 45408  
(513) 222-0062  
Key Personnel: Ray Steck

**Strong Arm Security, Inc.**

2228 Kenry Way  
So. San Francisco, CA 94080  
(414) 952-7710  
Key Personnel: R. Volosing, Pres.; Z. Volosing, Rec. Sec.

Hardplate drilling equipment for opening safes. The razor sharp Strong Arm drill bits are custom ground on a diamond wheel, come in 7 sizes and are economically priced. The Strong Arm drill rig is a versatile and time proven unit utilizing the Bosch Hornet drillmotor. The rig is compact.

**Superior Lock, Inc.**

15308 Harper Avenue  
Detroit, MI 48224  
(313) 521-2727

Key Personnel: Robert A. Clevio, President

Manufacturers of mortise, rim, thumb turn and dummy cylinders machined from solid bar brass.

**Supra Products, Inc.**

P.O. Box 3167  
Salem, OR 97302  
(800) 547-0252  
Key Personnel: Jim Young, Area Mgr.; Phil Barrett, Mktg. Mgr.; Scott Westfall, Mktg. Rep.

Key safes, lock boxes, fire department rapid entry key safes, cam locks, cam. Supra Products, Inc. has developed many styles of key safes for one key access control. We also manufacture our own patented lock and key, the high security Titan cam lock. Products are available through wholesalers.

**Tamperproof Screw Co., Inc.**

30 Laurel St.  
Hicksville, NY 11801  
(516) 931-1616  
Key Personnel: Alaina Picitelli, Pres.; Lewis Friedman, VP; George Friedman, Sales Mgr.

Tamperproof offers a complete line of corrosion-resistant security screws designed to prevent vandalism and thefts, yet allows easy access to authorized personnel with the matching tools. These screws are virtually impossible to remove without the special matching screwdrivers.

**Tank Security Inc.**

P.O. Box 297  
Mt. Kisco, NY 10549  
(914) 241-1187  
Key Personnel: John S. Ransom, Pres.; Robert A. Ransom, VP

Tank Security Inc. is a manufacturer and distributor of specialty safes and other specialty security systems. Major emphasis is on the Tank time delay cash safe line. Markets worldwide through dealer and distributor network. Information on all products is available from the company and dealer inquiries are invited.

**Tech Manufacturing**

P.O. Box 88  
Rockford, MN 55373  
(612) 477-5270  
Key Personnel: Jerry Mattson, Pres.

Tech Manufacturing's combination cam lock can easily convert keyed cabinetry to combination security by directly replacing a standard 3/4"

*Continued on page 66*



## Tech Manufacturing

Continued from page 64

diameter eyed cam lock. It is available in a rack-mountable sealed plastic display bag. The locks are available in three lengths: 5/8" (K2001-5/8"), (K3001-5/8"), and 1-1/8" (K4001-1-1/8").

### Telkee Inc.

Route 452  
Glen Riddle, PA 19037  
(215) 459-1100  
Key Personnel: T.L. Millar, Pres.;  
P.M. Lindley, Nat'l. Sales Mgr.

Telkee is one of the oldest and largest manufacturers of dual tag key control systems. Telkee systems feature a three way visible cross index system to identify keys alphabetically, by hook number, or key number. Systems are available to hold 20 to 2200 keys.

### Thug Bug of Connecticut, Inc.

P.O. Box 1062  
205 Nutmeg Rd., South  
South Windsor, CT 06074  
(203) 282-9220, (800) 666-6106  
FAX: (203) 291-9548  
Key Personnel: David Zingle, Pres.;  
Susan Zingle, VP/Secretary; James  
Morrow, Technical Manager

Thug Bug Auto Security products include the Avenger series of passive alarms (1500, 1000, 1001) which may interface with any hood lock. All models have passive or current sense capability. The Auto Saver is a passive alarm with starter kill and keypad. The correct code must be entered before vehicle can be started.

### Tice Industries

2219 N. Vancouver Ave.  
Portland, OR 97227  
(503) 284-0122  
Key Personnel: John Tice, Nancy Tice

### Trans-Atlantic Co.

440 Fairmount Ave.  
Philadelphia, PA 19122  
(215) 629-0400  
(201) 316-9444  
Key Personnel: Alan Paul  
Romanowicz, N.A. Millman

### Treskat Supply Corp.

1694 Montauk Hwy.  
Mastic, NY 11950  
(800) 645-5657, (516) 399-5656  
Key Personnel: Ray Nazzaro, Pres.

Manufacturers and distributors of the Belcat, Popalak, Kwiky, Didgivat, Ajax and foot long master followers, Tri Pac, Master pinning kits, computer software for locksmith, video courses on safe lock service, impressioning, master keying, auto lock service, burglar alarms and more. Call for free catalog.

### Trine Products Corp.

1430 Ferris Pl.  
Bronx, NY 10461  
(212) 829-4796  
Key Personnel: Gary Paley, Mktg.  
Mgr.; Sam Potter, Nat'l. Sales Mgr.;  
Michael Cahill, Mktg. Media Mgr.

Electric strikes, pushbuttons, transformers, magnetic door holders, chimes, switching mats, bells, buzzers.

### Tru-Hone Corp.

1721 N.E. 19th Ave.  
Ocala, FL 32670  
(904) 622-1213  
Key Personnel: James H. Gongelhoff

### U.S. Lock Corp.

77 Rodeo Drive  
Edgewood, NY 11717  
(800) 525-5000  
Key Personnel: Lawrence M.  
Schneider, Pres.; Lowell Schneider,  
Sec'y./Treas.

U.S. Lock manufactures a complete line of security and architectural hardware



**SRi**  
**SECURITY**  
**RESOURCES INC.**

*SRi and Tech Train  
Productions are the  
automotive specialists -  
your best source for  
automotive tools,  
manuals, and videos.*

[Click here for more information](#)



especially for locksmiths. The line features everything from padlocks to panic devices and is distributed through U.S. Lock Security Centers, a nationwide network of U.S. Lock authorized dealers.

#### Ultra Hardware Products

9246 Commerce Hwy., Box 679  
Pennsauken, NJ 08110  
(609) 663-5050  
Key Personnel: Mike Seidelman

#### U.S. Security Safe Corp.

3015 Dolores St.  
Los Angeles, CA 90065  
(818) 242-3156  
Key Personnel: Phillip Alfeld, Pres.;  
Larry McCall, VP Mktg./Sales.

High quality, low cost, fast delivery, dealers only, no direct sales. Complete line of floor safes, TL-15, TL-30, C rate burglary. Custom safes. U.S. Security dealers sell safes.

#### Valentine Lock Products

175 Valentine Lane, Box 111  
Yonkers, NY 10705  
(914) 964-8877  
Key Personnel: James R. O'Gara Jr.,  
C.E.O.

This young and energetic company provides field-tested, patented security products and tools to the residential, automotive and commercial locksmith. In-plant facilities range from prototype design to finished packaged products in wire or strip metal. Products include: The Problem Solver™, Handle-It™, Security-Edge™, Pic-A-Dilly™, Security Blank-It™, and Cam Power™. Manufacturing, packaging, marketing, advertising, and sales through wholesale worldwide distributors.

#### Vehicle Security Electronics, Inc.

21540-F Prairie St.  
Chatsworth, CA 91311  
(800) 932-9999, (818) 700-7900

#### Video Visions

161 Del Vale Ave.  
San Francisco, CA 94127  
(415) 681-9795  
(415) 495-7217  
Key Personnel: Steve Hess

#### Von Duprin, Inc.

2720 Tobey Dr.  
Indianapolis, IN 46219  
(317) 897-9944

Von Duprin is a manufacturer of door exit hardware and electrical security products and systems for over 75 years.

#### Wall Vaults Inc.

23875 Ventura Blvd. #102  
Calabasas, CA 91302  
(818) 887-4871  
Key Personnel: D. Alan Clark, Pres.;  
Mike Pedersen, Exec. VP; Ed Cain, Dir.  
Mktg.

Wall Vaults Inc. manufactures an in wall and a wall suspended vault for homes, condos, apartments, and the lodging industry. The wall vault uses a Medeco cam lock and is easily installed for effective patterned security. It has been endorsed by numerous hotel chains.

#### Weiser Lock

5555 McFadden Ave.  
Huntington Beach, CA 92649  
(714) 898-0811, (714) 891-0384

#### Weslock

13344 So. Main St.  
Los Angeles, CA 90061  
(213) 327-2770  
Key Personnel: Jim Locke, Mktg. Dir.;  
Ray Fondran, Reg. Mgr.;  
Wayne Durham, Reg. Mgr.

Weslock full line of residential lock sets, deadbolts and entry handles.

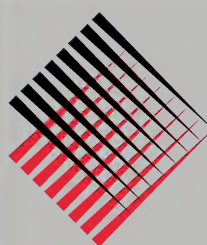

**STRATTEC™**

The world's largest  
producer of  
automotive locks  
and keys.

[Click here for more information](#)



**West Coast Chain Mfg. Co.**

P.O. Box 5050  
Pasadena, CA 91107  
(213) 681-6358  
FAX: (213) 681-6350  
Key Personnel: John J. Iacono, VP

Original manufacturer of Key-Bak and Mini-Bak, self-retracting key returns and other key security products. Both products have registered trademarks in most countries. Made in USA quality and are backed by a limited warranty policy.

**Winkhaus Corp.**

P.O. Box 2456  
Glenview, IL 60025  
(312) 998-1460

**Wilson Safe Co.**

3031 Island Ave.  
Philadelphia, PA 19153  
(215) 492-7100

**Windsor Industries, Inc.**

86 Ellnor Ave.  
Akron, OH 44305  
(216) 733-2266  
(800) 678-2552  
FAX: (216) 733-3103  
Key Personnel: E.L. Gibitz, Pres.; John

Beck, VP/General Mgr.; Carolyn Campbell, Office Mgr.

Windsor has exclusively designed a product for storing key blanks in mobile units. A 23½" x 25" lightweight steel Lock-Board has specific hooks that not only lock in place, but also prevent key blanks from falling off. Starter set available. Windsor's other fine storage products enable any handyman or mechanic to organize their work areas economically and efficiently.

**Winner International**

32 W. State St.  
Sharon, PA 16146  
(412) 981-1152  
Key Personnel: James Winner, Pres. and CEO; Bryn Dorricott, Senior Assoc.; Stan Winner, Senior Assoc.; Karren Winner, VP

"The Club" is an anti-theft device that comes in two versions, one for automobiles and one for trucks. It works as a slide and lock brace that locks onto and across your steering wheel. Once its locked in place, the extension end makes it impossible to turn the steering wheel. When attempting to turn the steering wheel, the end is stopped by anything immovable; the windshield, the door post, or the seat.

**Wolff Industries Inc.**

Route 5, Box 113  
Spartanburg, SC 29301  
(803) 583-8213 (SC)  
(800) 334-3832  
Key Personnel: Lee Wolff, Pres.; Mary Wolff, Sec'y.; Ken Hubbard, Eng.

Twice as Sharp is a professional quality, ball bearing grinder that can sharpen 25 to 30 scissors per hour. A unique polishing system doubles or triples the cutting ability. 30 day money back guarantee.

**Woodward Mfg. & Sales Inc.**

P.O. Box 56  
Sheboygan, WI 53082  
(414) 467-4057  
(800) 558-3536  
Key Personnel: Elmer Hazen, Pres.; Larry Market, VP; Sue Bosch, Office

Lectro-Truck, a battery powered hand truck. One man moves loads up to 600 lbs and more. Maneuvers load with pushbutton ease up and down steps, on and off trucks, semis, vans, loading docks, around corners, over landings, bulkheads. Strong steel construction moves with greater safety 1500 lb. loads.



***ASP - Your Auto Service  
Center for the World***

[Click here for more information](#)



Yale Security Division Scovill, Inc.  
P.O. Box 25288  
Charlotte, NC 28229-8010  
(704) 283-2101

**Young Bros. Stamp Works**

P.O. Box 75  
Muscatine, IA 52761  
(800) 553-8248

Key Personnel: Jim Young, Pres.

Young Bros. Stamp Works has manufactured steel letter and figure hand stamps since 1904. Young Bros. also has brass stencils and steel type and holders in stock.

**Z-Lock Co.**

1201 N. Catalina Ave., Box 949  
Redondo Beach, CA 90277  
(213) 372-4842

Key Personnel: M. Curran, Operations;  
C. O'Brien, Mktg.;

L. Johansen, Sales.

T-top locks for 280/300zx, Corvette 84-87, spare fire locks, locking gas caps, cassette radio locks, video home recorder locks, diesel fuel cap locks, tubular/cylinder cam locks, tailgate locks, king pin locks mostly locks not sold by larger companies.

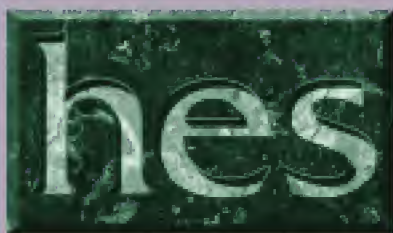

**The Innovation  
You Expect,  
with the  
Flexibility  
You Need!**

[Click here for more information](#)

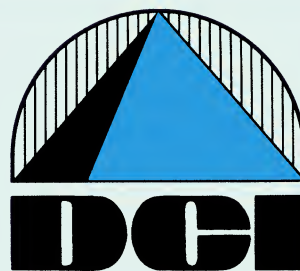

**We have it all.**

**Quality, Value,  
& Service.**

[Click here for more information](#)



# Distributors

**A-1 Auto Lock Distributors, Inc.**  
453 E. Girard Ave.  
Philadelphia, PA 19125  
(800) ALL-LOCK (Nat'l.)  
(800) 3-BRIGGS (PA)  
(215) 739-2808 (Local)

**A.A. Security Supply Dist.**  
210 Alpha Park Drive  
Cleveland, OH 44143  
(216) 442-0560  
Key Personnel: Sander Davis, Pres.

A.A. Security is a distributor of the finest, high security lock equipment including Falcon, Star, Lori, Wilson, Dominion, and proud to be a distributor of the new, high security Mul-T-Lock. A.A. Security gives the security you need.

**Accredited Lock Supply Co.**  
1161 Paterson Plank Rd.  
Secaucus, NJ 07094  
(201) 865-5015,  
(800) 652-2835 (NJ),  
(800) 772-3692 (Nat'l.)  
Key Personnel: Ronald Weaver,  
Pres.; Richard Chakov, Nat'l. Sales  
Mgr.

**Ace Lock & Key Inc.**  
5964 Baum Square  
Pittsburgh, PA 15206  
(412) 363-3328  
Key Personnel: Sandra Hunter,  
Pres.; Jim Matthews, VP; Jim Jewell,  
Sec'y./Treas.

Distributors of Folger Adam, Medeco, Adams Rite, Arrow, Rusco and others. Sales and service for commercial, industrial, prison facilities. Specializing in high security and card access.

**Ace Locksmith Co.**  
53 Brown Ave.  
Springfield, NJ 07081  
(201) 467-3820  
Key Personnel: Morris Goldstein,  
Pres.; Dan Goldstein, VP; Robin  
Cherkes, Sales Mgr.

Full line of locks, locksmith supplies, electronic locking devices, card access systems, electric openers, panic devices.

**Acme Security Systems**  
1922 Republic Ave.  
San Leandro, CA 94577  
(415) 483-6584  
(800) 343-2263

**Acme Wholesale Distributors, Inc.**  
P.O. Drawer 13748  
New Orleans, LA 70185  
(An LSDA Company)  
Local: (504) 837-7315  
Mid South: (800) 535-8793

**Acme-Southwest Lock Supplies, Inc.**  
8958 Kirby Dr.  
Houston, TX 77054  
(An LSDA Company)  
Local: (713) 668-0022  
Mid South: (800) 323-4470  
Key Personnel: Mike Groover, Pres.;  
Jay Denniss, Sales Mgr.; Eric Folse,  
General Mgr./Houston.

Locksmith distributor of all major lock manufacturers including Russwin, Sargent, S & G, Kwikset, Weiser, Dexter, Securitron, etc. Star, Gardall, Major, LSDA safes, key machines, exit devices, door closers, and all LSDA products.

**Aero Lock**  
P.O. Box 16434  
Memphis, TN 38186-0434  
(800) 423-0276  
Key Personnel: Jim Clark, Owner

Aero Lock produces key sets designed to aid the locksmith in opening and fitting keys quickly and easily to many types of locks. "Tryout" sets, cut key sets, and depth key sets are available for domestic and foreign cars, motorcycles, boats, luggage, and office furniture. Free catalog by request.

**Aetna Hardware**  
5909 W. Lisbon Ave.  
Milwaukee, WI 53210  
(414) 445-1800,  
(800) 242-5577 (WI),  
(800) 321-2011 (Nat'l.)  
Key Personnel: Earl Olson, Pres.; Tom  
Olson, VP; Jim Olson, VP

Adams Rite, Alarm Lock, All Lock, American Padlock, Amerock, Baldwin, Bommer, Corbin Cabinet Lock, Folger Adams, HPC, Ilco, Kwikset, Lab, LCN Closers, Master Lock, Medeco, National, Norton, Schlage, Stanley, Trine, Von Duprin, Weiser, and Yale.

**Akron Hardware Consultants**  
2579 S. Arlington Rd.  
Akron, OH 44319

(800) 321-9602 (Nat'l.),  
(800) 321-6459 (OH)  
Key Personnel: Joseph E. Orihel, Pres.;  
Charles Roger Judy, Sec'y/ Treas.;  
Herb Crute, GM.

Akron Hardware Consultants is a specialized wholesale distributor for Corbin architectural hardware, Russwin architectural hardware, Adams Rite glass door hardware, CCL cabinet hardware, Lori decorative hardware, and Akro Mils storage bins and cabinets.

**Alarm Supply Co.**  
10 Old Bloomfield Ave.  
Pine Brook, NJ 07058  
1-800-631-8054  
Key Personnel: Alex Jameson, VP  
Sales; Norm Carlo, Nat'l. Sales Mgr.;  
Stan Gabay, Director of Mktg.

Alarm Supply is a major distributor of security products. The company carries competitively priced door alarm products for manufacturers including Alarm Lock, Detex, etc.

**Allegheny Lock Co. Inc.**  
1006-08 Cottman Ave.  
Philadelphia, PA 19111  
(215) 745-1217  
Key Personnel: Bob Mastrangelo,  
Fred Pfeil, Eddie Pfeil, Sales Dept.

Medeco Security Locks and keys - all levels. Same day service: shipping - keying and masterkey systems. Medeco keys cut. Fast service on large quantity our specialty.

**Wm. B. Allen Supply Co., Inc.**  
Allen Square  
The 300 Block, North Rampart St.  
New Orleans, LA 70112-3106  
(504) 525-8222,  
(800) 462-9520 (LA),  
(800) 535-9593 (Nat'l.)  
Key Personnel: Frank Soehnlein, GM;  
Richard Harris, Mktg. Mgr.; Joe Labadie, CCTV.

Wm. B. Allen carries, in stock, complete lines of fire systems, burglary systems, CCTV/professional video, business telephone systems, professional sound systems, card access systems, intercom systems, nurse call systems and vacuum systems from over 400 manufacturers.



**All-Ware Distributing, Inc.**

135 W. 2950 South  
Salt Lake City, UT 84115  
(801) 487-3227,  
(800) 662-6529 (UT),  
(800) 453-6430 (Nat'l)

Key Personnel: Jarry Zaharias,  
Pres.; Rolf Aase, VP; Larry Clark, Mgr.

We are a complete line distributor of locksmith supplies. We also carry over 150 major lines of locks and supplies. We also rebuild key machines. Minimum order \$25.00. We ship same day if called before noon.

**Alpha Door Controls, Inc.**

207 Sunset Blvd.  
Sherman, TX 75090  
(214) 868-0099

Key Personnel: Al Gilman, Pres.; Tracy Gilman, VP.

Selling to locksmiths only. Safe drills, electrical components, card readers, electric strikes, Dexter locks, American padlocks, exit devices, kit type burglary alarms, etc.

**American Lock & Supply, Inc.**

4411 E. La Palma Ave.  
Anaheim, CA 92807

(714) 996-8882, (213) 585-0224,  
(800) 854-8775 (Nat'l.)

Key Personnel: Jim DeForrest, Chairman of the Board; Sean DeForrest, Pres.; Bill Power, VP Sales

American Lock & Supply, Inc. is one of the nation's largest lock and locksmith supplies distributor. With six branches, total warehouse space reaches over 110,000 square feet, featuring 20,000 different line items from nearly 200 manufacturers. The Anaheim based firm provides many marketing programs to aid customers in increasing their businesses.

**Andrew's Wholesale Lock Supply**

921 Chestnut St.  
Lebanon, PA 17042  
(800) 544-0519  
(717) 274-8733

Key Personnel: Richard A. Rudy (Andy), Owner

A full line distributor for Briggs & Stratton. A full line distributor for Auto-Security products. An E.S.P. product distributor.

**Apex Security Hardware Corp.**

1201 36th Street  
Brooklyn, NY 11218

(718) 438-2115 (NY)  
(800) 232-1117 (Nat'l.)  
FAX: (718) 438-3327

Key Personnel: Eli Guth, Pres.

Apex Security, a distributor of most major lock lines since 1976, offers same day shipment at competitive prices. Apex features a full line of Arrow locks including Arrow locksets in Schlage "C" and "E" keyways. Some of the other lines stocked by Apex are: Medeco, Folger Adams, Simplex, Detox, Master, Monarch, Rofu, Ilco, Marks, American, All Lock, and Precision Hardware. They have recently added the Norton door closer line.

**Aristo Sales Co., Inc.**

27-24 Jackson Ave.  
Long Island City, NY 11101  
(718) 361-1040,  
(800) 221-1322

Key Personnel: Leonard Rosenblatt, VP Mktg.; Jules Rosenblatt, VP Sales.

Specializing in auto locks and alarms, locksmith supplies and all major brands: Briggs & Stratton, All-Lock, Auto Security, Arrow, Segal, American & Master, Detox, Precision, electric door openers, Loxl, Corbin, HPC, Star, Taylor, Ilco and many more.



**HPC, Inc.**  
**Designing Excellence and Manufacturing**  
**Quality since 1956**

[Click here for more information](#)



**Aritech Corp.**  
25 Newbury St.  
Framingham, MA 01701  
(800) 432-3232

Aritech Distribution Centers in 29 cities stock burglar and fire alarm systems and equipment, CCTV, accessories and tools. We provide a large selection, technical assistance, quick delivery and low competitive prices.

**Armstrong's Lock & Supply Inc.**  
1440 Dutch Valley Place, NE  
Atlanta, GA 30324

(An LSDA Company)  
(404) 875-0136, Local  
(800) 241-3682, SE WATS  
(800) 282-4533, GA WATS  
Key Personnel: D. Viri Mullins, Pres.;  
Robert L. Beglin, VP; Charlie Pendleton,  
Outside Sales Mgr.

Full line distributors of locksmith supplies, electrical devices, safes, locks, and various other security products. Miami Branch: 1766 N.E., 205th Terrace, North Miami Beach, FL 33179. Tampa Branch: 601 W. Hillsborough Ave., Tampa, FL 33603. Excellent service at competitive prices.

**Baxter Systems Inc.**

1934-D John Towers  
El Cajon, CA 92020  
(619) 449-8000  
Key Personnel: Dennis R. Baxter, Pres.;  
Gertrude E. Baxter, Sec'y.; Jean Barber,  
Treas.

Manufacturer of tryout keys, guide keys, code books. Distributor of key blanks, Continental Micro cards, Auto Security foreign car locks, All Lock products, and others. Serving locksmiths throughout the world since 1962.

**Baylis Locksmith Supplier**

7 Pamaron Way  
Novato, CA 94947  
(800) 772-3965 (CA),  
(800) 227-0503 (Nat'l.),  
(415) 883-0505.  
Key Personnel: Buzz Baylis, Pres.

A large distributor of automotive locks and keys in the country with more than 2000 foreign and domestic part numbers in stock. Featured is a complete line of Briggs & Stratton and Auto Security Products locks and parts along with rubber headed key blanks to fit most foreign and domestic cars.

**Bell's Security Sales Inc.**

411 Bloomfield Ave.  
Bloomfield, NJ 07003  
(201) 743-3709  
Key Personnel: Richard Middleton

**Berg Wholesale**

P.O. Box 29169  
Portland, OR 97229  
(800) 243-8887 (Nat'l.),  
(503) 220-0000 (OR)  
Key Personnel: Catherine, GM;  
Ken Pederson, Nat'l. Sales Rep.

Offering same day shipment. Factory discount pricing. Cylindrical locks, mortise locks, closers, panic devices, deadbolts, cylinders, key blanks, pins, key kits, exit devices, holders and more. Restricted keyways available. Master keying, construction keying done quickly.

**Blaydes Lock Co., Inc.**

2335 18th St., N.E.  
Washington, DC 20018  
(202) 832-7100  
(800) 424-2650  
Key Personnel: Edward J.  
Hildebrand, Pres.; Tom Rakes, VP.; Bob  
Chanin, Sales Mgr.

Mid-Atlantic area's professional security hardware supplier since 1954.

**Boston Lock & Safe Co., Inc.**

30 Lincoln St.  
Boston, MA 02135  
(617) 787-3400  
(800) 252-5757  
Key Personnel: Harry J. Stoia, Pres.;  
James C. Condit, VP.; J. Norbert Bartho-  
lomew, VP.

We stock for immediate shipment one of the largest selections of Falcon and Medeco locks. We also stock the largest selection of S & G safe locks, SLS, Fichet-Bauche, Steelage, and New England safes for immediate shipment. Our service department maintains parts availability for domestic and foreign made high-security safes.

**Boyle & Chase**

86 Finnell Dr.  
Weymouth, MA 02188  
(617) 337-3904  
Key Personnel: Mike Rotondi

**Canada Lock Products**

70 Floral Parkway  
Toronto, Ont. M6L 2C1  
(An LSDA Company)  
(416) 248-LOCK (5625), 248-6268  
(800) 268-1306 (Ontario)  
(800) 387-7755 (Canada only)  
Key Personnel: Jack Laufer, Pres.;  
Steve Dyson, Gen. Mgr.; Steve Witten-  
berg, Sales Mgr.

Wholesale distributors for major security hardware manufacturers for over 50 years. Specializing in safes, electrical devices, exit hardware, auto locks, high security hardware, key blanks, door closers, locksmith tools and supplies and door hardware. Offering prompt service throughout Canada.

**Capitol Lock & Hardware Co., Inc.**

3730 Georgia Ave. NW  
Washington, DC 20010  
(202) 882-9502  
(800) 323-5625  
Key Personnel: W. Schlegel, Pres.; B.  
Dillon, Mgr.; M. Bernard, Sales.

Full line distributor of locks, keys, key machines, high security padlocks, combination locks, electronic access controls. One of the largest stocks of locks and key blanks on the east coast. Ship most orders from stock. Specialize in high security devices of all kinds. Ship worldwide; give us a call.

**Classic Fixtures, Inc.**

641 County Road 39/A  
P.O. Box 2174  
Southampton, NY 11968  
(516) 283-7791  
(800) 626-2262  
Distributors of architectural hardware including Baldwin, Stapley, Omnia, Schlage, and others.

**Commonwealth Lock Co.**

1853 Mass. Ave.  
Cambridge, MA 02140  
(617) 876-3301  
Key Personnel: Edward A. Mayer,  
Pres./Treas.

We specialize in lock hardware.

**Cook's Supply, Inc.**

4770 Fox St., Unit #13  
Denver, CO 80216  
(An LSDA Company)  
(303) 294-0567 (Local)  
(800) 624-4018 (CO Wats)  
(800) 445-4008 (Surrounding States)  
Key Personnel: Jack Dunn,  
Operations Mgr.

Wholesale distributor of locksmith supplies and related security hardware. Stocking distributor for ASSA and Medeco cylinders and deadbolts, Aanon, Major, and LSDA safes as well as various other major manufacturers. No minimum orders, great service and competitive pricing. Same day shipping on orders called in by one p.m.



**Craftmaster Hardware Co. Inc.**

176 Kansas St.  
Hackensack, NJ 07601  
(800) 221-3212,  
(201) 646-9355

Key Personnel: Michael Spingeld,  
Pres.; Lawrence Kraut, VP Acctg.

All standard brands including Arrow, Iico/Unican, Kwikset, Schlage, Star, All-Lock are available from this 35 year old, third generation family run stocking distributor. Metropolitan location enables them to locate non-stock items quickly.

**Deering Engraving**

19 S. Franklin Ave.  
Lynbrook, NY 11563  
(516) 593-4740

**DI Mark International**

3233 Skyway Dr.  
Corp. Hgr. 3D  
Santa Maria, CA 93455  
(800) 235-2435  
(800) 225-7994 (In CA)

Key Personnel: Mark Pirman/Diane Pirman, Owners

Good assortment of key machines, security boxes, locksmith tools of the finest quality. Factory representatives for Borkey key machines, and several other European manufacturers.

**Direct Safety Co.**

7815 S. 46th St.  
Phoenix, AZ 85044  
(602) 968-7009

Key Personnel: Richard Gilbert,  
Mktg. Mgr.; Tom Reine, Prod Dev. Mgr.;  
Barb Patrow, Sales.

Direct Safety Co. is a national catalog distributor of safety and security devices to business and industry. Catalogs feature alarms, barricades, communication systems, lighting, mirrors, security systems, signs, monitors, and vehicle safety products. Write or call for a free catalog.

**Dixie Lock Supply, Inc.**

2025 NW 167th St.  
Miami, FL 33056  
(305) 625-5525

Key Personnel: Syd Friedman,  
Pres.; R. Friedman, Sec'y./Treas.;  
Fred Cohen, Controller.

Wholesale distributors of major American lines: key blanks, locks, locksmith supplies, door hardware, safes, and electronic security.

**Doyle Lock Supply**

2211 West River Road North  
Minneapolis, MN 55411

(612) 521-6226

(800) 33-DOYLE, (800) 333-6953

Key Personnel: Robert Hromadko,  
Pres.; Paul Justen, Operations Mgr.;  
John Wolter, Purchasing Mgr.

Adams Rite, Master, Yale, Von Duprin, SDC, Locknetics, Major Safe, S & G, Simplex, HHM, Norton, LCN, Medeco, Schlage, and Weiser. Complete line of original key blanks as well as Iico. 180 other manufacturers products in stock. In 1987 joined USCAN Lock Distribution group which offers the opportunity to buy at advantageous pricing and pass on to our customers. Also complete line of private label products including fire safes. Our sixty-eighth year in business.

**DRK Specialties**

38087 Young Dr.  
Fremont, CA 94536  
(415) 790-2619

Key Personnel: Don Kuhn,  
Owner/Pres.; Gloria Kuhn,  
Sec'y./Treas.

DRK Specialties is the complete key ring accessory source for locksmiths seeking the latest key ring styles and innovations. Current best sellers include sound activated key finders, colorful coils, brass snaps and key lites. Our large inventory includes popular standard key rings at competitive prices.

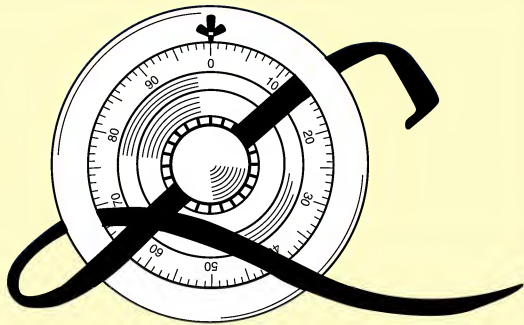

**Lockmasters has a  
44 year history of  
training security  
professionals.**

[Click here for more information](#)



**Installation Tools  
The Professionals Choice**

[Click here for more information](#)



**Dugmore & Duncan Inc.**

30 Pond Park Rd.  
Hingham, MA 02043  
(800) 225-1595

Key Personnel: Chuck Cullum,  
Pres.

Sargent Lock distributor. Extensive inventory on hand for immediate delivery. Also distributors for Medeco locks, featuring the new Biaxial key systems.

**C.H. Edwards, Inc.**

P.O. Box 775 — Hwy. 11 South  
Greenville, NC 27834  
(800) 334-3642 (Outside NC)  
(919) 756-8500 (In NC)

**Electric Lock Supply**

1043 W. Manchester Ave.  
Inglewood, CA 90301  
(213) 568-9885

Key Personnel: Dennis Crabtree, Ken Strait

Complete access controls distributor. Adams Rite, Aiphone, Alarm Controls, Alarm Lock, Edwards, EPC, Folger Adam, Frontier, Galaxy Controls, GRI, Hirsch, Intermatic Linear, Marlee, Master Electronics, Microwave Sensors, Micro State, Monthard, Nutone, Preferred Technology, Rofu, Securitron, SDC, Trine, Von Duprin, Yuasa.

**Empire Security Supplies**

4600 B Nesconset Hwy.  
Fort Jefferson Station, NY 11776  
(516) 928-0559  
(800) 432-2345

Key Personnel: Ira Levine, Pres.; Arnold Rabinowitz, VP; Arthur Dean, Sales Mgr.

Empire Security Supplies is a young and rapidly growing distributor of locksmith and hardware supplies. We have been in business for six years, and are constantly expanding our line of manufacturers products. We are one of the largest wholesale distributors on Long Island, New York. We believe in personalized service and quality merchandise.

**Ewert Wholesale Hardware Inc.**

4709 W. 120th St.  
Alsip, IL 60658  
(312) 597-0059,  
(312) 597-0825

Key Personnel: Wes McKenney,  
Purchasing Agent/Sales; Brian King, Sales; Ciella King, Accts. Receivable/Payable.

**Express Hardware**

1203 S. Northwest Hwy.  
Barrington, IL 60010  
(800) 323-7447  
(800) 851-1897 (In IL)

Express Hardware is a full line supplier of both Schlage locks and Von Duprin exit devices.

**Foley-Belsaw Machinery Co.  
Locksmith Division**

6301 Equitable Rd.  
Kansas City, MO 64120  
(800) 468-4449 (orders only)  
(800) 328-7140 (customer service)

**Fortress Safe & Lock**

340 Northland Blvd.  
Cincinnati, OH 45246  
(513) 772-4392

**Fradon Lock Co., Inc.**

467 Burnet Ave.  
Syracuse, NY 13203  
(315) 472-6988

**Fried Bros. Inc.**

467 N. 7th St.  
Philadelphia, PA 19123  
(800) 523-2924 (Nat'l.),  
(800) 356-5050 (PA)  
Key Personnel: Alex  
Ebrahimzadeh, Pres.

Fried Bros. Inc. was established in 1922 in Philadelphia. Presently we supply the locksmiths from two warehouses located in Philadelphia and Phoenix, Arizona. We stock locks, padlocks, key machines, door closers, exit devices, decorative hardware, safes, vaults, mail boxes and intercoms.

**Grace's Wholesale & Supply Div.**

214 East 2 St.  
Hastings, NE 68901-5217  
(402) 462-2737

Key Personnel: H. Roger Grace, Prop.

Corbin Cabinet Lock Div., Schlage Lock Co., Taylor Lock Co., Circle-Ess key machines. Stocking locks, parts and key blanks, as well as some tools. New and re-sharpened key machine cutters, the latter on an exchange basis as well as outright sale.

**Grandview Hardware Co.**

525 W. Seneca St.  
Ithaca, NY 14850  
(607) 273-0526

Distributors of Baldwin mortise locks and decorative hardware.

**Great Lakes Supply**

2301 Sassafras St.  
Erie, PA 16502  
(814) 453-4746

**H & H Lock & Security**

9140 Gaither Rd.  
Gaithersburg, MD 20877

(301) 948-1996, (800) 772-9811

Key Personnel: Paul E. Jacobson,  
Pres.; Gregory A. Jacobson, VP.

Master distributor for Weslock products, stocking full line, entry handles, levers and locksets. Distributor for Alarm Lock, Baldwin, Omnia, S. Parker Hardware, Schlage.

**Halsco Wholesale**

1995 Bronxdale Ave.  
Bronx, NY 10462  
(212) 828-7239

Key Personnel: Joe Bender

**Hardware Agencies Ltd.**

1220 Dundas St. East  
Toronto, Ontario Canada M4M 1S3  
(416) 462-1919, (800) 268-6741

Key Personnel: Paul Halberstadt,  
Pres.; James Roberts, Mktg. Mgr.

Full line locksmith supplier. Lock and door hardware, key blanks, key machines, locksmith tools and equipment, high security lock lines, padlocks.

**Hardware Sales & Supply**

35950 Industrial Rd.  
Livonia, MI 48150  
(An LSDA Company)  
(313) 591-1150 (Local)  
FAX: (313) 591-7289

(800) 521-0955 (Midwest)  
(800) 482-8605 (MI)  
Key Personnel: Milt Goldman, Pres.; Arnie Goldman, Marketing Mgr.; Ken Heeren, Operations Mgr.

Hardware Sales & Supply Co. is a full-line stocking distributor of locksmith supplies since 1925, specializing in LSDA products, access control hardware, high security locks and key blanks, stocking a wide variety of product lines such as Medeco, Arrow, and Securitron.

**Hardware Specialties**

R.D. 2, Box 28A  
Dubois, PA 15801  
(814) 371-8694

**Hardware Suppliers of  
America, Inc.**

213 Mill St.  
Winterville, NC 28590  
(800) 682-9625 (NC),  
(800) 334-5625 (Nat'l.)

Schlage, Dexter, Baldwin, Von Duprin, Simplex, Rixson-Firemark, Norton, Hager and McKinney in stock for immediate delivery. Complete lines of above manufacturers stocked at all times. Manufacturer's wholesale prices.

**Harper Lockpac, Inc.**

7414 Big Cypress Dr.  
Miami Lakes, FL 33014  
(305) 557-4449

Key Personnel: Leslie H. Utman, Pres.

*Continued on page 82*



**Harper LocPac, Inc.**  
*Continued from page 80*

"Trailer Jailer" is the only lock system to offer trailer owners the security provided by an indestructible locking mechanism. Unlike other trailer locks, the Trailer/Jailer covers the entire hitch handle. 16-gauge steel housing protects the entire locking system in the hooked or unhooked position.

**H. Hoffman Co.**  
7330 W. Montrose Ave.  
Chicago, IL 60634

(An LSDA Company)  
(312) 456-9600 (Local)  
(800) 942-0217 (Illinois)  
(800) 323-1918 (Midwest)  
H. Hoffman Co. Distribution Centers:  
(800) 382-9449 (Indianapolis, IN).  
(800) 392-1303 (St. Louis, MO).  
(800) 472-9191 (Milwaukee, WI).  
(800) 247-8217 (Cleveland, OH)  
Key Personnel: Al Hoffman, Pres.; Jeff Adams, Operations Mgr.; John Bosworth, Sales Mgr.; Karen Hoffman Kahl, Mkt. Mgr.

H. Hoffman, the "House of Locks" has over 50 years experience as a distributor of a full line of security hardware and related products, i.e., locksmith supplies, safes, electronic controls, novelty items, etc., enjoying a reputation built on quality services. Same day delivery, selling catalog, monthly flyers, competitively priced serving mid-America.

**H.S.S.**  
12915 W. 8 Mile  
Detroit, MI  
(800) 521-2202  
(800) 482-3000 (MI)

**Independent Hardware Inc.**  
14 S. Front St.  
Philadelphia, PA 19106  
(215) 925-5306, (800) 346-9464  
Key Personnel: Frank Stanco, Pres.; Vincent Campagna, VP

Stocking wholesale distributor of Schlage, Kwikset, Dexter, Corbin, Norton, Master, Yale, Von Duprin, Adams Rite, Arrow, Ilco, National, Folger Adams, Sargent, Simplex, Chicago, Dorma, Bommer, Alarm Lock, Lab, Lori, Rixon, Quincy, Seidle, Russwin, Hinges. Centrally located in Philadelphia. We offer same day shipping.

**Independent Hardware West Inc.**  
293 East Redondo Beach Blvd.  
Gardena, CA 90248  
(213) 515-2224  
(800) 346-9464  
Key Personnel: Frank Stanco, Pres.; Vince Campagna, VP

Stocking wholesale distributor of Kwikset, Schlage, Master, Ilco, Simplex, Yale, Corbin, Norton, Arrow, Dexter, Alarm Lock, National, Folger Adams, Lab, American Device, Bommer, Von Duprin and many more! Centrally located in Los Angeles county. We offer same day shipping.

**Instant Hardware Delivery**  
12321-B Wilkins Ave.  
Rockville, MD 20852  
(800) 437-5837 (Nat'l.),  
(800) 492-6805 (MD),  
(301) 231-5020  
Key Personnel: Beverly Vigue, VP;  
Jayme Wilburn, Sales Rep.; Kenneth Domurot, Sales

I.H.D. is an established wholesale distributor center located in Rockville, MD supplying exclusively to contract houses, suppliers and locksmiths. We represent three manufactured lines of commercial/residential hardware, namely Schlage, Von Duprin and Valli and Colombo.

**medeco**<sup>®</sup>  
HIGH SECURITY LOCKS

***The market leader  
in locking systems  
for security, safety,  
and control.***

[Click here for more information](#)



**Intermountain Lock & Supply**

3106 S. Main  
P.O. Box 15271  
Salt Lake City, UT 84115  
(801) 486-0079 (UT),  
(800) 453-5386 (U.S.)

Key Personnel: Jay Hickenlooper,  
Pres.; Bob Steinman, Mgr.

A successful locksmith needs a successful distributor. At Intermountain Lock & Supply, we have made a commitment to the locksmith with everyday low prices, same day delivery, thirteen member professional sales staff, over 16,000 inventory items, and a computerized catalog. Toll free west of Mississippi.

**Hans Johnsen Co.**

8901 Chancellor Row  
Dallas, TX 75247  
(214) 631-1566

Key Personnel: Howard H.  
Johnsen, Pres.; Saul Espinoza, VP Lock  
Supplies; Bob Fowler, Sr. VP Mktg.

**JLM Wholesale, Inc.**

2469 West Predmore  
Lake Orion, MI 48035  
(800) 522-2940

Key Personnel: Ray Baldwin, Ken  
Andridge, Jan Mirku

We have in stock for immediate delivery Folger Adams, LCN Closers, Locknetics Security Engineering, Roton and Von Duprin products. Help with applications is available from our engineers. Most orders are shipped same day as received. For further information call 1-800-522-2940.

**A.T. Jones & Son**

1456 Broadway  
Detroit, MI 48226  
(313) 965-1455

**Jo-Van Distributors**

96 Crockford Blvd.  
Scarborough, Ontario  
Canada M1R 3C3  
(416) 752-7210  
(800) 268-5731  
FAX: 416-752-3845

Key Personnel: Leonard J. Passarello  
C.P.L., Pres.; John G. Passarello, Buyer

Your one-stop distributor. Fast, reliable  
service. Usacan distribution.

**K-D-L Hardware Supply Inc.**

1621 8th Ave.  
Seattle, WA 98101  
(206) 682-7383

KDL Hardware Supply Inc. has been in  
the security hardware business since  
1919. We distribute products from over

200 manufacturers. In 1985 we joined  
the "USCAN" distribution network which  
provides the opportunity to purchase at  
most competitive pricing. Competitive  
pricing and great service have been  
KDL trade marks.

**Kenco Supply Co.**

2531 North 85th St.  
Omaha, NE 68134  
(800) 228-2266, (402) 397-8291

Key Personnel: Charles Kent, Pres.;  
Robert Kent, VP; Steve Thillander,  
Warehouse Mgr.

At Kenco, we offer a free catalog just a  
phone call away. We also have no min-

imum order and we are a full line dis-  
tributor offering 12,000 different  
items. At Kenco your satisfaction is our  
most important goal. Kenco, where we  
haven't forgotten that service is  
important.

**Kenton Locksmith Supplies, Inc.**

10 Lincoln St.  
Kansas City, KS 66103  
(913) 432-2739 (Local)

(800) 255-5280 (KS)  
(800) 255-4130 (Mid-America)  
Key Personnel: Dorthy I. Kenton,  
Owner; Scott D. Thomson, Purchasing  
Agent

*Continued on next page*

**NATIONAL  
AUTO LOCK SERVICE, INC.**

***National Auto Lock Service, Inc.  
offers a wide range of equipment  
and services for the Automotive  
Locksmith. From tools and hard to  
find key blanks to transponder  
programming, we can take the  
mystery out of car service. We  
accept credit card orders, and  
can ship COD. Contact us for the  
latest in automotive technology.***

[www.laserkey.com](http://www.laserkey.com)



**Kenton Locksmith Supplies**  
*Continued from previous page*

Distributor for all major manufacturers. All types of locksets, key blanks, key machines and padlocks, automotive, cam mortise, rim cylinders. Locksmith tools and security hardware.

**The Key Connection**  
1932 NE 151st St.  
Miami, FL 33162  
(800) 237-8446

**Key Hardware Co.**  
2400 San Fernando Rd.  
Los Angeles, CA 90065  
(213) 225-4255  
Key Personnel: Jim Curr, VP/GM

The "new" Key Hardware Co., specializing in the wholesale distribution of security hardware and related products for over 60 years. From high security locks to key blanks, hand tools to key machines, door hardware to drill bits, Key Hardware represents over 150 manufacturers and stocks thousands of line items.

**Key Sales & Supply Co.**  
9950 Freeland Ave.  
Detroit, MI 48227  
(313) 931-7720  
Key Personnel: Sheldon Wiener, Owner

Full line stocking distributors of key blanks, key machines, locks, locksmiths supplies and hardware.

**Key Supply**  
362 - 7th St.  
San Francisco, CA 94103  
(415) 626-2526

**Keystone Safe & Equipment Wholesalers**  
625 South Eighth St.  
Philadelphia, PA 19147  
(215) 627-7736  
Key Personnel: Edward C. Domisch, Pres.; Patricia Krause

Keystone Safe & Equipment Wholesalers are exclusive distributors of the Keystone "Protector," one and two hour fire safes and computer safes and the "Keystone Viking" burglary resistive fire safe. Distributors of other selected safe manufacturers.

**M.D. Kramer Locksmith Supplies**  
535 Liberty Ave.  
Brooklyn, NY 11207  
(718) 647-7800, (800) 221-9674

Key Personnel: Joel Kramer, Pres.; Anthony Cani, Sales Mktg. Mgr.

One of the largest distributors of popular and hard-to-find products.

**T.L. Kupferman & Co., Inc.**  
243 07 131 Ave.  
Rosedale, NY 11422  
(718) 527-6363  
The Auto Lock Co.™

**Locks Co.**  
2050 NE 151 St.  
N. Miami, FL 33162  
949-0700 (Local)  
(800) 327-5187 (Nat'l.)  
(800) 432-4981 (FL)  
Key Personnel: Milton Dorn, Pres.; Mark Dorn, VP; Liz Searle, Sales.

Full line distributor with all major lines in stock. High security lines such as Medeco, ASSA, and Abloy are no problem. We also cover electronic security and access systems. We specialize in product knowledge and delivery time.

**The Locksmith Store Inc.**  
1229 E. Algonquin Rd., Unit E  
Arlington Heights, IL 60005  
(312) 364-5111  
Key Personnel: Tom Swiderek, Pres.; Jack Swiderek, Rico Chavez  
Wholesale locksmith supplies.

**The Lockware Co. Inc.**  
1613 West Pratt St.  
Baltimore, MD 21223-2493  
(301) 233-4022  
Key Personnel: James D. Bolfar, Pres.; Julius E. Eierman, Sec'y./Treas.; P. Edward Nowlin, Buyer.

We are distributors of builders security hardware, locksmith supplies and tools. Established 1932. Wholesale and retail. Distributors of locks and key blanks of leading manufacturers.

**Major Lock Supply, Inc.**  
1825 Via Burton  
Anahelm, CA 93806  
(714) 991-4666, (213) 979-3402  
Key Personnel: W.E. DeForrest, Sr., Pres.; Bill DeForrest, Jr., VP/GM; Linda DeForrest, Controller.

Distributor for all "Major" brands of security hardware. Representing over 200 manufacturers of KeeBlok, Cylinder Guard, Sho-N-Tel, and narrow stile double and single door bolt.

**Mayflower Sales Co., Inc.**  
614 Bergen St.  
Brooklyn, NY 11238  
(718) 622-8785, (800) 221-2052  
Key Personnel: Bill Swetow, Pres.; Harris Goldstein, Sales Mgr.; Brian O'Dowd, Mgr. Lock Div.

Adams-Rite, All Lock, American Lock, Arrow, Auto Security, Briggs & Stratton, Chicago Lock, Corbin, Detex, Folger Adam, Gardall Safes, HPC, Ilco, Lori/Kaba, Marks, Master, Medeco, National Lock, Parker, Rofu, Sargent, Securitron, Security Engineering, Simplex, Star Safes, Yale. Full line distributors of locksmith supplies and builders hardware. Since 1917.

**Maziuk & Co. Inc.**  
1251 W. Genessee St.  
Syracuse, NY 13204  
(315) 474-3959  
Key Personnel: Stanley Maziuk Sr., Pres.; Stanley Maziuk Jr., VP.

**McDonald Dash Locksmith Supply Inc.**  
1584 Two Place  
P.O. Box 16907  
Memphis, TN 38186-0907  
(901) 346-8111, (800) 238-7541  
Key Personnel: E.R. Ferguson, Pres.; Jim Thomas, GM; Burma Hanson, Office Mgr.

Wholesale distributors of 15,000 inventory items of 100 plus manufacturers to locksmiths, hospitals, schools and other institutions since 1945. Locks, locksmith tools, closers, exit devices, key machines, lock parts, key blanks, and technical books. Same day shipment of orders in by 12:00 CT.

**McManus Locksmith Supply**  
1208 Central Ave.  
Charlotte, NY 28299  
(704) 333-9112

**Midland Hardware Dist.**  
P.O. Box 7043  
13 Raritan Rd.  
Oakland, NJ 07436  
(800) 526-9000 (Nat'l.),  
(800) 562-2059 (NJ)  
Key Personnel: John Warren, Dir. of Operations & Sales; Frank Begnoche, Dir. of Purchasing & Mktg.

We are a stocking distributor of door hardware for the following manufacturers: Baldwin, Dexter, Kwikset, Marks, Norton, Omnia, Precision, Schlage, Simplex/Unican and Von Duprin. Orders shipped same day if placed by 2:00 est. Call about our catalog.



**Mid-South Locksmith Supply, Inc.**  
New Getwell Rd.  
Memphis, TN 38118  
(901) 795-6987

**Mid-States Security Corp.**  
247 Woodwork Ln.  
Palatine, IL 60067  
(312) 358-0760

Key Personnel: Bob Gullett, Pres.; K.C. Gullett, VP

We carry Adams Rite, American Lock, Continental Micro, Detex, Fort Lock, Medeco, Norton Closers, Sidro, Simplex, Trine, and Yale. We are authorized service center for Medeco, Fort Lock and American Lock. We cut keys, set up masterkey systems, key to number. We have a restricted key section from Medeco.

**Midwest Wholesale Hardware**

5121 Front St.  
Kansas City, MO 64120  
(800) 821-8527 (Natl.),  
(816) 241-5663 (MO)

Stocking wholesale distributor for Russwin, Schlage, Falcon and Norton. Many other manufacturers' lines available. Next day shipment on stock items. Call toll free for information and price catalog.

**The Jim Miller Co.**  
100 Harbor Cr.  
New Orleans, LA 70126  
(800) 423-6068, (504) 244-1995

Locksmith supplies and tools, lock devices, safes, builders hardware. "A knowledgeable sales department."

**J. Nathan Hardware Specialties, Inc.**

161 Comfort St.  
Rochester, NY 14620  
(716) 325-3330  
(800) 634-2580  
FAX: (800) 537-1940

Key Personnel: James Nanthan Bono, Pres.; Toni Caiola Bono, Sec./Treasurer; Mark Putman, Customer Svc.

Our business obligation is meeting customers needs by offering service, knowledge and quality products. We maintain a large inventory of locks, locksmith supplies and builder's hardware, such as Adams Rite, HPC, Iico, Kwikset and Schlage. "Try us...We can help."

**The National Locksmith**  
1533 Burgundy Pkwy.  
Streamwood, IL 60107

(312) 837-2044  
Fax: (312) 837-1210

Key Personnel: Marc Goldberg, Editor/Publisher; Tom Miodoch, Ad Sales Manager; Barbara Coulam, Circulation Manager.

*The National Locksmith* magazine informs you monthly about all news and technical information you need. We publish a series of technical books and code books to educate locksmiths.

**New England Door Closer Inc.**

694 Union St. P.O. Box 28  
West Springfield, MA 01090  
(413) 733-7889

Key Personnel: Ronald Longley, Pres.

Stocking distributor for most American makes of door closers. Door closer repair. Sale of obsolete door closer springs and parts.

**Ohio Travel Bag Co.**

811 Prospect Ave.  
Cleveland, OH 44115  
(216) 621-5963

Key Personnel: Austin Oppenheim, Pres.; Paul Gallin, VP;

*Continued on next page*

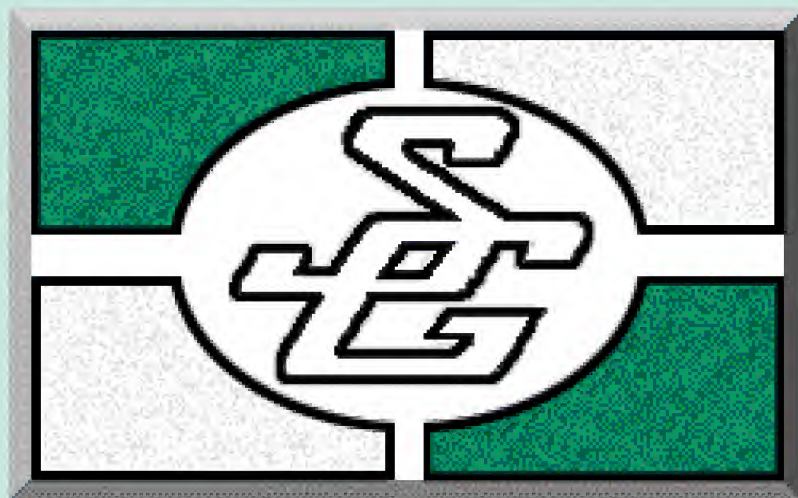

*Make Sargent & Greenleaf's  
Comptronic locks your choice for  
electronic safe locking solutions.*

[Click here for more information](#)



### Ohio Travel Bag

*Continued from previous page*

Complete line luggage keys domestic and imports. Luggage and "case" hardware—locks, catches, fasteners, hinges, stays bottom feet, handles, etc. Over 8100 items, call catalogued. Manufacturers leather key cases and key rings of all types. All catalogued.

### Omaha Wholesale Hardware

P.O. Box 3628  
Omaha, NE 68103  
(402) 444-1672  
Key Personnel: Jack Maun

### Orchard Lock Distributors, Inc.

30 Edmond St.  
Hamden, CT 06517  
(800) 233-2146 (Nat'l. WATS)  
(800) 547-5128 (CT WATS)  
(203) 865-8106 (Local)  
Key Personnel: Larry Federico, Dir. of Operations; Bill Simmons, Nat'l. Sales Mgr.; Norma D. Maslar, Reg'l. Account Executive

Orchard Lock Distributors is a full line, nationwide distributorship serving the locksmith trade. The many major brands in stock include Arrow, Schlage, Yale, Dexter, Weiser, Abloy, Medeco, American, Master and many others. Our new larger facilities allow us to serve our customers better with more variety, faster delivery and competitive prices. Call us toll-free for expert personalized service.

### Pasek Corp.

9 W. Third St.  
South Boston, MA 02127  
(617) 269-7110

### Agences W. Pelletier (1980) Inc.

651 Notre-Dame Ouest, Ste. 375  
Montreal, Quebec  
Canada H3C 1H9  
(514) 842-4661  
Key Personnel: Gilles Bourdage, PDG

Ilco, Dominion Lock, HPC, Webster, Sargent & Greenleaf. We are a distributor of security hardware for locksmiths and industries.

### Pimlico Key Service Inc.

5254 Reisterstown Rd.  
Baltimore, MD 21215-5082  
(800) 367-7400 (MD),  
(800) 638-3815 (Nationwide)  
Key Personnel: John Trouland, Pres.

Locksmith supplies: Yale, Schlage, Kwikset, Sargent, Falcon, Arrow,

Medeco, Lorr, Unican, Ilco, HPC, Folger Adams, Corbin Cabinet, National, Marks, Adams Rite, Briggs & Stratton, Auto-Security, Valley Forge.

### Pro-Lok

2760 S. Harbor Blvd. #H  
Santa Ana, CA 92704  
(714) 641-1249, (800) 826-9888  
Key Personnel: Adam Weinraub, Pres.; David Weinraub, VP

Complete set of auto lock out tools including the GM slide lock tool. The set includes six tools and an illustrated manual for under \$30.00. We also carry: scope lights, 4 in 1 key decoders, no-spill pegboard key hooks, custom invoices and 3 copy NCR telephone service call books.

### E.L. Reinhardt Co.

3250 Fanum Rd.  
Vadnais Heights, MN 55110  
MN (800) 792-1025  
Out of State (800) 328-1311

### Safeman Supply Co.

1104 NE 126th Ave.  
Vancouver, WA 98684  
Key Personnel: Dave McOrmie, Pres.

### Safemasters Co. Inc.

10 Smithfield St.  
Pittsburgh, PA 15222  
(800) 633-9977, (412) 261-5770  
Key Personnel: Steve Goldberg,  
Operations Mgr.; Lou Mazza, Ind. Sales

### Edward Saucedo & Son Co., Inc.

709-711 N. Copia  
El Paso, TX 79903  
(915) 566-8605  
Key Personnel: Edward Saucedo,  
Pres.; David E. Saucedo, VP;  
Bernadette Saucedo, Treas.

Single source service for high security hardware. Stocking distributors of Detex, Dorma, Schlage, Master Padlock, Miwa, Abloy, Lorr-Kaba.

### Secure Industries

263 Hendrix St.  
Brooklyn, NY 11207  
(718) 647-7722  
Key Personnel: Anthony Carl,  
Sales Mktg. Mgr.

### Security Hardware Co.

3427 Waiialae Ave.  
Honolulu, Hawaii 96816  
(808) 732-5369  
Key Personnel: Herm Salz, Pres.  
M.A.G. Engineering, Falcon, DOM, Zeiss-Ikon, Lab, Hori Lock and Builders Hardware, Olympic.

### Security Lock Distributors

P.O. Box 196, 21 Albany St.  
Newtonville, MA 02160-9998  
(617) 332-5000 (Local)  
(800) 843-5625 (MA WATS)  
(800) 847-5625 (US WATS)  
FAX: (617) 964-7376  
Key Personnel: Sid Schwartz, Pres.; David Schwartz, VP; Jeff Schwartz, VP; Martin D. Wiener, Controller

Security Lock Distributors is a wholesaler distributor of locks and security products. We are the nation's largest distributor of Arrow locks carrying their complete product line. We also carry the complete inventories of Adams-Rite, Folger Adams, Simplex, Bommer Mailboxes and Locknetics-Security Engineering. Our strengths are the depth of our lines as well as our knowledgeable sales staff.

### Septon Incorporated

194 Daniel Street  
Hackensack, NJ 07601  
(201) 343-8822  
(800) 537-8752  
Key Personnel: Richard Septon

### Serrubec Inc.

2069 Chartier Ave.  
Montreal (Dorval), Quebec  
Canada H9P 1H3  
(514) 631-6791, (800) 361-0243  
Key Personnel: Joseph Mastro, VP  
Wholesale locksmith supplies.

### M. Shepse Co./Div. Amsco Bionics

21st and East Carson Sts.  
Pittsburgh, PA 15203  
(412) 381-4900  
Key Personnel: Gilbert Shepse,  
Pres.; Sandy Zaremberg, VP

Kwikset, Weiser, Arrow, Schlage, Sargent, Medeco, S&G, Master, National, Corbin Cabinet, Ilco, American, Stanley.

### Shield Supply & Services Ltd.

Unit 17 - 1391 St. James St.  
Winnipeg, Manitoba,  
Canada R3H 0Z1  
(204) 774-1921  
Key Personnel: C.M. "Coley"  
Kaufman, Pres./GM; Shawn McIntosh  
Sales Mgr.

### D. Silver Hardware Co. Inc.

145 Lafayette Ave.  
North White Plains, NY 10603  
(212) 674-0227, (914) 761-0224,  
(800) 431-1570 (Nat'l.)

*Continued on page 90*



**D. Silver Hardware**

*Continued from page 88*

Key Personnel: Charles Schwarcz,  
Pres.; David West, GM

Since 1906. In stock Medeco, Master,  
Arrow, Kwikset, HPC, Trine, Rofu, Adams  
Rite, Folger Adams, Simplex, Iico, Star,  
Segal, Schlage, Marks, Ideal, Wright,  
ESP, All Lock, Guard and many more.  
Call toll free outside New York.

**William Silver & Co. Inc.**

42 Ludlow St.  
New York, NY 10002  
(212) 982-8720  
(800) 543-LOCK (Outside NY only)  
Key Personnel: Frank "Barry"  
Korenge, Pres.; Jerome "Jerry" S. Gold-  
stein, Sec'y./Treas.

We are full line distributors, primarily car-  
rying locksmith supplies, key blanks and  
key machines. We carry limited supplies  
of alarm products.

**Silver Sales**

2701-C W. 15th St., Ste. 291  
Plano, TX 75075  
(214) 867-4545. (800) 258-LOCK  
Key Personnel: Bill Silver, Judee  
Brummette-Silver, Owners

Carry a complete line of Sargent &  
Greenleaf products. Since 1982, supply-  
ing S & G products to customers through-  
out the U.S.

**S. Simons Inc.**

33 Brighton St.  
Belmont, MA 02178  
(An LSDA Company)  
(617) 489-5140

S. Simons, Inc. operating since 1884, is  
one of this country's oldest distributors of  
locksmith supplies and related hard-  
ware. Supplying a full line of tools, locks,  
equipment, keyblanks, key machines,  
and all LSDA products to the trade.  
Located just outside of Boston, S. Simons  
Inc. services the Northeast.

**Space Age Alarm Dist., Inc.**

1001 East 167 Street  
Bronx, NY 10459  
(212) 378-6280  
(800) 247-7942 (Outside NY)  
Key Personnel: Mr. John Millan, Pres.;  
Mrs. Myriam Valderrama, V.P.

We at Space Age Alarm Dist., carry a full  
line of Valley Forge foreign car locks,  
Lock Technology key machines with  
biaxial Medeco adapter, Star key  
blanks, American padlocks, Anes auto  
alarm systems, auto air horns, security  
screws and more.

**Southern Lock & Supply Co.**

10910 Endeavor Way,  
P.O. Box 1980  
Pinellas Park, FL 34290-1980  
(813) 541-5536, (800) 282-2837  
(FL), (800) 237-2875 (Nat'l.)  
Key Personnel: Marvin Cutson,  
Pres.; Charlie Armstrong, VP  
Sales/Mktg.; David Matthies, VP Op.

Southern Lock and Supply Co. has been  
a supplier to the security and building  
industries for nearly half-a-century. In all,  
we stock more than 200 manufacturers  
representing more than 7500 inventory  
items, ranging from strikes to key  
machines. Join the growing number of  
security professionals enjoying our  
service.

**Standard Wholesale  
Hardware Inc.**

45 Ludlow St.  
New York, NY 10002  
(212) 925-9041, (212) 925-9042

Distributors of locksmith supplies, tools  
and hardware.

**Jack Stearman Ltd.**

420 West 6th Ave.  
Vancouver, B.C. Canada V5Y 1L2  
(604) 872-8415  
Key Personnel: John Stearman,  
Pres.;



**SCHWAB CORP.**

*Fire protection for your vital records.*

**It's not safe unless  
it's Schwab Safe.**

[Click here for more information](#)



**Stone and Berg**

99 Stafford St.  
Worcester, MA 01601  
(617) 753-3551  
Key Personnel: Jack Berg, Peter Berg

**Strauss Safe & Lock Co., Inc.**

1220 High St.  
Des Moines, IA 50309  
(515) 288-9571  
(800) 532-4107 (IA Watts)  
Key Personnel: Jim Blanco, President;  
Andy Gay, Marketing Mgr.; William P.  
Cunningham, Purchasing Agent

**M. Taylor Inc.**

5635-45 Tulp St.  
Philadelphia, PA 19124  
(An LSDA Company)  
(215) 288-5588, (800) 222-2277  
(PA), (800) 233-3355 (Mid-Eastern)  
FAX: (215) 288-5511  
Key Personnel: Jules DeLuca,  
Pres.; Don Amole, Sales Mgr./  
Computer Coord.; Peggy Blake, Tele-  
Mktg. Mgr.

We are distributors of most of the lead-  
ing lines in our industry. M. Taylor Inc. has  
been in business for more than 80 years.  
We give service which is "Tailored" to  
your needs.

**Top Notch Distributors**

P.O. Box 189, 413 Erie St.  
Honesdale, PA 18431  
(800) 233-4210  
3688 Research Way  
Carson City, NV 89701  
(800) 722-4210

**Trans Atlantic**

420 Fairmount Ave.  
Philadelphia, PA 19123  
(800) 523-9956  
Key Personnel: Alan Paul  
Romanowicz, Nat'l. Sales Mgr.

Supplying the locksmith trade since  
1954, door closers, cylinders,  
key-in-knob sets, mortise hinges, UL  
spring hinges, door stops, mortise locks  
and 3000 other security related items.

**Tungsmann & Co., Inc.**

4415 W. Estes Ave.  
Chicago, IL 60646  
(312) 679-3940

**Tweeds Locksmith Inc.**

Wholesale Supply Div.  
601 Elm Ave.  
Portsmouth, VA 23704  
(804) 399-2180

Key Personnel: Gary Waterman, Sales  
Mgr.; Don Kuebler, Sales; Larry Forres-  
ter, Stock/Sales.

Distributors for all leading manufac-  
turers; Schlage, Ilco, Sargent & Green-  
leaf, Kwikset, Yale, Weslock, American  
and Master Lock, Simplex, electronic  
cyper locks, etc. Over 40 years in  
business.

**United Safes of America**

1316 Bruce Rd.  
P.O. Box 227  
Oreland, PA 19075-0227  
(800) 345-SAFE (PA), (800) ALL-SAFE  
(Nat'l.)  
Key Personnel: Richard J. Weaver,  
Pres.; JoAnn Di Pasquale, Sec'y.; Vicki  
Carliles, Mktg. Coordinator

Distributing Adesco, Amadillo, Crown  
Safe, Detroit Mini-Safe, Fire-King,  
General Metal Craft, Mellink and NKL  
Safe Co.

**Veehoff Supply Co.**

1515 Lake Ave.  
P.O. Box 361  
Storm Lake, IA 50588  
(712) 732-1836  
Key Personnel: B.H. "Ben" Veehoff,  
Owner

Nationwide distributors of automobile  
master key sets, car unlocking tools, and  
Star key blanks. We ship to all 50 states  
and Canada.

**Vern Rose Tool Processing**

8605 Commerce  
San Diego, CA 92111  
(619) 560-9769

**Wadsworth White Inc.**

5873 New Peachtree Rd., Suite 100  
Atlanta, GA 30340  
(404) 458-9449

**Ray Ware Hardware**

4048 Herschel St.  
Jacksonville, FL 32205  
(904) 389-6659  
Key Personnel: Tom Jones, Ken Kuder

**West Coast Hardware Dist.**

9412 Irondale Ave.  
Chatsworth, CA 91311  
(818) 341-8944, (818) 341-8945

Locksmith and builders supplies and  
hardware. Electronic systems and  
devices.

**Wharco**

305 North First St.  
P.O. Box 549  
Martins Ferry, OH 43935

(800) 848-5440 (Nat'l.)  
(800) 628-1133 (OH)  
FAX: (614) 633-5779

Key Personnel: Paul Parnell, Manager  
Russwin and Von Duprin products in  
stock for quick shipment. Also stocking  
Norton, LCN, P. & F. Corbin, Hager, and  
Schlage. Experienced personnel, very  
knowledgeable of hardware products  
and applications. Call for price list.

**Wilco Supply**

5960 Telegraph Ave.  
Oakland, CA 94609  
(415) 652-8522  
Key Personnel: H.D. Williams, Pres.;  
Roy J. Griffin, VP; VI Fountain,  
Sec'y./Treas.

Over 28,000 inventory items: hardware,  
builders hardware, tools, adhesives, and  
locksmith supplies. Serving California,  
Oregon and Nevada.

**Williams Key Co., Inc.**

2206 Locust St.  
St. Louis, MO 63103  
(314) 231-2411, (800) 392-4224  
(MO), (800) 325-1779 (Nat'l.)  
Key Personnel: Erma L. Williams, Pres.;  
George Koester, Op. Mgr.; Mike  
Rachock, Sales Mgr.

Stocking distributor of all major lines of  
locksmith tools/supplies. Visit our Bald-  
win showroom or call about this beauti-  
ful lock line. We welcome your inquires.

**Woodshed Locksmith**

108 Woodland Dr.  
Cumming, GA 30130  
(404) 889-9663  
Key Personnel: Cecil Merritt

**Samuel Zeldin Inc.**

1700 North 5th St.  
Philadelphia, PA 19125  
(215) 236-8600  
Key Personnel: Claire Zeldin, VP.  
Automotive locks is our business. Serving  
the entire United States.

**Zipf Lock Co.**

P.O. Box 987  
Columbus, OH 43216  
(614) 228-3507, (800) 848-1577  
(Nat'l.), (800) 282-1597 (OH)  
Key Personnel: William Zipf Jr., Pres.;  
Richard Zipf, VP; Steve Zipf, VP

Zipf Lock Co. was established in 1905.  
We specialize not only in the popular  
locks but also the hard to find lock func-  
tions and designs in Arrow, Kwikset,  
Schlage, Weiser, Weslock and many  
more. We are constantly adding to our  
inventory of over 10,000 items. Give us a  
try.



# Schools

## Acme School

Locksmithing Div.  
11350 S. Harlem  
Worth, IL 60482  
(312) 361-3750

Acme's Locksmithing Course was developed for the individual with no experience or prior training, but who wishes to learn the craft and begin a locksmithing career, or for the individual with previous experience who wants to expand and further his abilities and techniques. This course is an in-house, hands-on, training program where you will learn by doing.

## Foley Belsaw Institute

6301 Equitable Rd.  
Kansas City, MO 64120  
(800) 468-4449 (orders only).  
(800) 328-7140 (customer service)

## California Institute of Locksmithing

14721 Oxnard St.  
Van Nuys, CA 91411  
(818) 994-7426  
Key Personnel: Joe Bergen, Vice Pres.; David Williams, Assoc. Director; C.H. Hasekian, Director.  
Resident school established in 1972.

## HPC Learning Center

P.O. Box 2093  
Schiller Park, IL 60176

(312) 671-6445

Key Personnel: Jerry Hoffman, Pres.; Steven Spiwak, Dir.

The HPC Learning Center offers three intensive, hands-on courses of instruction which include Basic Locksmithing (12 weeks), Advanced Locksmithing (12 weeks), and Safe Manipulation (1 week). Students will work in an actual locksmith shop as part of the course.

## Lockmasters

5085 Danville Rd.  
Nicholasville, KY 40356  
(606) 885-6041  
Key Personnel: Clayton Miller, April Truitt

## Locksmithing Institute

1500 Cardinal Dr.  
Little Falls, NJ 07424  
(201) 256-4512

## NRI Schools

3939 Wisconsin Ave.  
Washington, DC 20016  
(202) 244-1600  
Key Personnel: Jim Valentine, Media Director.

Locksmithing and electronic security training is now available from NRI Schools. NRI gives you training in both locksmithing and electronic security systems in one complete new course.

You train at home, according to your

schedule. Write to us today for your free catalog.

## NY School of Locksmithing

1466 Broadway  
New York, NY 10036  
(800) 223-6466  
Key Personnel: Bert Michaels, Pres.; Thurman Harrison, Dir.; Paul Viertels, Asst. Dir.

Nationally accredited resident school. Home study masterkeying course. Tool and equipment discount sales to graduates and locksmiths nationally.

## Security Education Plus

P.O. Box 497  
Nicholasville, KY 40356  
(606) 887-6027  
Key Personnel: Rex E. Parmelee, Pres.; Paul V. DeMichele, VP

Formed in 1985, we provide the security industry with on-site training programs relating to safes, vaults and other types of security containers that incorporate combination lock, time locks, and key locking mechanisms.

## Universal School of Master Locksmithing

3201 Fulton Ave.  
Sacramento, CA 95821  
(916) 482-4216  
Key Personnel: Rick Vanina, Pres.  
Correspondence and shop training. Working shop environment.

# Miscellaneous

## Armco Sales, Inc.

P.O. Box 952  
Westminster, CA 92684  
(714) 821-4403  
Key Personnel: Mike Ghorso, Pres.; Dick Ugland, Vice Pres.; Allan Oblath, Sec./Treas.

Manufacturers' representatives to the locksmith and security wholesaler; contract and builders hardware wholesaler, and the full-line hardware wholesaler. Covering the states of Calif., Ariz., and Nevada.

## National Alarm Computer Center, Inc.

P.O. Box 12520  
Santa Ana, CA 92712  
(714) 834-1208,  
Outside CA (800) 854-3392,  
(213) 687-3917  
Key Personnel: Mark Schubert, Marketing; Kenneth R. Gresty, VP Customer Relations

N.A.C.C., Inc. is a complete all service, U/L monitoring central station for licensed alarm companies, offering a wide variety of state-of-the-art monitoring techniques for all makes of digital dialers and alarm panels. N.A.C.C., Inc. is equipped with a fully redundant computer system.

## Robert W. Fischer

5217 W. Flight Ave.  
Santa Ana, CA 92704  
(714) 892-1133, (714) 839-6272  
We sharpen all types key duplicating machine cutters.

## Programmed Marketing

260 Mill St.  
Greenwich, CT 06830  
(203) 531-5424  
Key Personnel: Nick Ohnell, Ted Grejciak  
Hudson Lock.



# Year End Index

## Alarms

- The Keepsafer Plus Pro . . . . . Feb., 29
- Crimestopper Security Products . . May, 23
- Auto Alarm Installation Tip . . . . . Aug., 11

## Automotive (domestic)

- Using the GM Plug Puller . . . . . Jan., 11
- Ford 10 Cut Key Generation . . . . . Feb., 9
- '85 Mercury Cougar Face Cap Replacement . . . . . Feb., 11
- Removing Ford Ignition Locks . . . . Feb., 11
- '88 Pontiac Grand Prix Trunks . . . . Mar., 9
- Tapping GM Sidebar Trunk Locks . . . . . Mar., 78
- Ford Truck and Bronco Locking Problem . . . . . Apr., 10
- '87 Buick Limited Trunk Lockout . . Apr., 10
- Cutting Ford 10 Wafer Keys by Code . . . . . June, 10
- Opening GM Trunks with Sidebar Locks . . . . . June 14
- '86 Oldsmobile Ciera Service . . . . June, 101
- '84+ Ford 10 Wafer Door Locks . . . July, 16
- Servicing the Ford Probe . . . . . July, 34
- New Chrysler Locks . . . . . July, 60
- Ford Broken Key Removal . . . . . Sept., 11
- Installing Ford Spring Retainers . . Sept., 14
- Ford Taurus/Sable Trunk Opening . . . . . Sept., 15
- Ford Taurus Trunk Lock Tip . . . . . Oct., 13
- '77 Ford Mercury Ignition Removal . . . . . Oct., 62
- Opening Chevrolet Astro Vans . . . Nov., 12
- The 1989 Mercury Scorpio . . . . . Nov., 28
- GM Reference Chart . . . . . Dec., 14
- Removing Spear Head Clips . . . . Dec., 20
- GM Side Bar Glove Box . . . . . Dec., 126
- '78 Chevy Wheel Pulling . . . . . Dec., 130

## Automotive (foreign)

- Servicing Volvo Trunk Locks . . . . Jan., 12
- Servicing the New BMW . . . . . Jan., 34
- Open a Jaguar Push-up Trunk . . . . Feb., 10
- A New Mercedes Lock . . . . . Feb., 42
- Keying a 1980 Mazda . . . . . Mar., 13
- Servicing the Datsun . . . . . Mar., 40
- Volvo Ignition Techniques . . . . . Apr., 59
- The Mitsubishi Precis . . . . . May, 38
- The New Ford Festiva Import . . . . May, 83
- '88 Honda Civic and CRX . . . . . June, 43
- 230 Suzuki 4-Wheel Facts . . . . . June, 103

- Getting a Honda Prelude Code . . . . July, 114
- '88 Toyota Calica Trunk Work . . . . July, 150
- Servicing Pundra Locks . . . . . Oct., 58
- '86-'88 Hyundai and Mitsubishi Ignitions . . . . . Nov., 16
- The MGB Ignition Caper . . . . . Nov., 50

## Automotive (general)

- Gas Cap Lock Alternatives . . . . . Feb., 11
- Pulling Custom Steering Wheels . . Feb., 11
- Installing an Auto Alarm . . . . . Aug., 11
- Telescoping Steering Columns . . . Nov., 12

## Business

- Do-It-Yourself Lawsuits . . . . . Jan., 57
- Building Your Profits . . . . . Mar., 20
- Don't Get Ripped-Off! . . . . . Apr., 89
- Change and the Locksmith . . . . . June, 24
- Locksmith Price Survey . . . . . July, 59
- Management for More Business . . July, 62
- 25 Ways to Improve Business . . . July, 128
- Management for More Business . . Aug., 55
- Managing for More Profit . . . . . Sept., 87

## Car Opening (domestic)

- '88 GMC Pickup Entry . . . . . Feb., 10
- Chrysler Round Door Locks . . . . Mar., 12
- '86 Dodge Electric Lock Vans . . . . Mar., 12
- Open the Ford Bronco II . . . . . Mar., 13
- '88 Ford Taurus Opening . . . . . Apr., 99
- Open the Grip Handle Corvette With a Twist . . . . . July, 113

## Car Opening (foreign)

- '86 & '87 Supra Opening . . . . . May, 77
- Tool for '87-'88 Nissan Hardbody Truck . . . . . Aug., 11

## Car Opening (general)

- Pro-Lok Locksmith Tools . . . . . Mar., 32
- High Tech Tools . . . . . Mar., 36
- Opening Vertical Lock Rods . . . . . July, 11
- Handling Loose Cams & Rods . . . July, 151
- Fixing Lock Rod Tools . . . . . Dec., 14
- A Car Opening Trick . . . . . Dec., 120

## Codes

- Codes for Toyota Corolla (G001-G2000) . . . . . Apr., 78
- Chicago Codes (2001X-3000X) . . . . May, 71
- Hudson Small Pin Codes (7000-8000) . . . . . June, 91
- Honda Civic Codes, 1987+ (5001-8442) . . . . . July, 130
- 1989 Chrysler Codes (F0000-0659) . . . . . Aug., 68

- 1989 Chrysler Codes (F0660-1394) . . . . . Sept., 89
- Hudson Mail Box Lock Code . . . . . Oct., 69
- Master Padlock Codes (3001-3200) . . . . . Nov., 80

## Combination Locks

- Finding Presto Combinations . . . . Jan., 9
- Combination Changing Procedures . . . . . Jan., 42
- Working on La Gard Boltworks . . . Mar., 48
- A New Lock for a Hall Safe . . . . . June, 102

## Door Hardware

- Don-Jo Door Products . . . . . Apr., 46
- Inter-Lockit from Aable . . . . . Apr., 48
- The DorGard from Scotsman . . . . Apr., 52
- Lori Door Hardware . . . . . July, 26

## Electronic Locks

- Schlage's New Key N' Keyless Lock . . . . . Jan., 19
- Install Electromagnetic Locks . . . . Feb., 21
- Security Engineering's 3940 . . . . Feb., 26
- Airport Uses Magnalocks . . . . . Feb., 31
- Electronic Deadbolts . . . . . Apr., 20
- Von Duprin Exit Devices . . . . . Apr., 27
- Electromagnetic Locking . . . . . Apr., 28
- Vingard Hotel Lock System . . . . Apr., 101
- Locking with Electricity . . . . . July, 54

## Humor

- 'Smithing on a Computer . . . . . Mar., 58
- One More Night Call . . . . . May, 68
- A Locksmith Buys a Lincoln . . . . Sept., 70
- A Locksmith's Tale . . . . . Nov., 54

## Impressioning

- Getting Marks on Master Padlocks . . Mar., 13
- Making a Good Impression . . . . . May, 54

## Installation

- Install Mag Strikes in Concrete . . . Jan., 11
- Lining Up a Weiser X Deadbolt . . . Jan., 12
- Von Duprin Exit Devices . . . . . Feb., 50
- Eliminate Deadbolt Sagging . . . . Mar., 9
- Interchangeable Cores on Glass Doors . . . . . Mar., 13
- Retrofitting Adams-Rite . . . . . Mar., 60
- Door Closer Installation . . . . . Mar., 66
- Install a Door Reinforcer Plate . . . . Apr., 12

*Continued on page 100*





**SRI and  
Steve Young  
are working  
together to  
bring you  
the best in  
locksmith  
tools and  
supplies.**

[Click here for more information](#)

### Installation

*Continued from page 98*

Mortise Template for Plastic Latch Box Shield.....	May, 14
Installing a Peep Hole .....	June, 10
Maintaining Adams Rite .....	July, 50
Trailer Deadbolt Installation .....	Dec., 14

### Key Machines

Attachment Organizer .....	Feb., 12
Modification of the Exacta .....	May, 9
Get a Close Throat Cut on a Belsaw 200 .....	May, 14
Make a Belsaw 200 Portable .....	July, 17
Modifying a Belsaw 200 .....	Sept., 15
The HPC/Silca Club.....	Oct., 26
Unidentified Antique Key Cutter ..	Oct., 66

### Keys & Blanks

Garage Rim Cylinder Blanks .....	Feb., 10
Stamping Blanks Quietly.....	Feb., 12
Garage Rim Cylinder Blanks .....	Feb., 71
Key Blank Corner .....	Mar., 72
Key Blank Corner .....	Apr., 92
LeFebure Model PL-80 Depths & Spacings .....	May, 79
Modifying Blanks to Shim Locks ..	July, 16
Key Blank Corner .....	Aug., 84
Tip for Generating First Keys .....	Sept., 11
Blank for Long Lock Co. Lock .....	Oct., 67

### Locks

Falcon Interchangeable Cores .....	Jan., 62
Antique Locks in France .....	Feb., 56
Yale Removable Cores.....	Mar., 54
A New Magnetic Lock .....	Apr., 30
Old Schroder Lock Specifics.....	May, 81
A Rare 4-Way Lock .....	Aug., 78
The Preso-Matic Lock .....	Sept., 58
Sliding Glass Door Lock I.D. ....	Oct., 61
Illinois Double Sided Locks .....	Nov., 56
Antique Independent Lock Key ...	Nov., 79
The BiLock System.....	Dec., 103
Garcy Lock Identified .....	Dec., 131

### Locksmithing

Masterkeying By Computer .....	May, 63
Format & Rules for Progression ..	June, 14
Masterkeying for the Pro.....	June, 76
Masterkeying Corbin Locks .....	July, 116
Pinning the Corbin Core .....	Aug., 48
Advice to Novice Manipulators ...	Aug., 52
Key Manipulation .....	Sept., 98
Current Masterkeying Trends .....	Oct., 69
Reading Impression Marks .....	Nov., 14

### Miscellaneous

Locksmith Distributor Profiles .....	Jan., 22
Locksmith Manufacturer Profiles ...	June, 26
American Lock Plans Future .....	July, 30
NLSA Celebrates 40th Anniversary .....	Aug., 64
Locksmith Liability .....	Dec., 128

### Padlocks

Working with a Yale 7313 .....	Jan., 65
The Sterling Rotary Shackle.....	Feb., 71
Custom Lock with Yale Keyway... ..	Feb., 73
Impressioning Master .....	Mar., 12
Opening the S&G 8088 .....	Mar., 76
Master 2001 Combination Template .....	Apr., 11
Yale Mogul Identified .....	Apr., 99
Eagle Lock & Jack Knife Key ...	Apr., 100
Recombining American's 747 ..	May, 60
Master Adds New Products .....	June, 49
The Padlock the Ate West Virginia .....	June, 84
Yale 803 Padlock Particulars ...	June, 102
Removing an American Lock 747 Cylinder .....	July, 16
Decoding the Corbin Padlock.....	July, 48
Seoul Lock Key Blank Problem ..	July, 151
Repairing Hurd Padlocks .....	Aug., 34
Keying Fort's Tubular Padlock ...	Aug., 60
Opening S&G's 8077AB Combination Padlock.....	Aug., 78
Blanks for a Common Push-key ..	Aug., 80
Decoding the "Guard" or "Prestolock" .....	Oct., 13
Open Master Combination Locks ..	Nov., 14
Telephone Co.-Type Padlock for I.D. ....	Nov., 79

### Safe Deposit Locks

Diebold's 175-70 Lock .....	Jan., 62
Opening Diebold's 175-70 .....	Apr., 62
Making a First Key .....	May, 9
Opening Diebold's 175-70 Tip ...	Oct., 13

### Safes

Safe Work can be Deadly .....	Jan., 46
Guardsmen Fire Safe Facts .....	Jan., 64
Manipulating Group 2 Locks .....	Jan., 66
Servicing a Jammed Adesco .....	Jan., 67
Manipulating with Mr. Breeze ...	Feb., 32

### Manipulating a Murphy Wall Safe

Safe .....	Apr., 101
------------	-----------

Opening a Trumbull Safe .....	May, 78
Opening a Meilink Box.....	June, 10
Floor Safe Installer .....	June, 12

Manipulating a Mosler.....	June, 70
Fiberoptics by Olympus .....	July, 67

A 30 Second Safe Opening .....	Aug., 11
--------------------------------	----------

Combination Change on a Mosler Fire File .....	Sept., 10
--	-----------

Opening a Mosler Lug Door .....	Sept., 36
---------------------------------	-----------



Manipulating a Push Down Lock .....	Sept., 50
Safe Drilling Techniques .....	Oct., 47
Opening a Floor Safe .....	Oct., 54
Herring Hall Marvin Opening Procedures .....	Oct., 67
Installing Floor Safes .....	Nov., 14
Opening a Diebold Vault Door ...	Nov., 46
An Evening with Intersec .....	Nov., 61
"Thomas Skidmore" Safe Photos .....	Nov., 75
Old Mosler OB Opening .....	Nov., 78
The Cochran A-B-C Method .....	Dec., 11
Armor 8" Square Door .....	Dec., 11
Aligning The Dial Ring .....	Dec., 12
Fighting A Mosler TRTL-30 .....	Dec., 107
<b>Service &amp; Repairs</b>	
Creating a One-Directional Lock Cylinder .....	Jan., 10
Dealing with Stripped Screws ...	Feb., 11
Disassembling Uniloc Lever Handles .....	Feb., 72
Weiser "A" Cylinder and Plug Removal .....	Mar., 10
Disassembling Schlage Knob Locks .....	Mar., 10
Servicing a Jammed Russwin Mortise Cylinder .....	Apr., 9
The Weiser D9470L Deadbolt ...	Apr., 11
Making Long Desk Lock Tailpiece .....	Apr., 11
Rekeying Kwikset and Taiwan Locks .....	Apr., 12
Servicing an Antique .....	Apr., 42
Make a Dummy Lock Cylinder ...	May, 12
Bypassing File Cabinet Locks ...	May, 15
Removing Weiser "A" Series Cylinders .....	May, 78
Falcon Interchangeable Core Locks .....	May, 80
Two Security Tool Cabinet Manufacturers .....	June, 9
Emergency Exit Lock Service .....	June, 11
Security at the Mall .....	June, 38
Decoding Simplex Combinations .....	June, 82
Retrieving Parts Lost in a Hollow Metal Door .....	July, 13
Servicing Deadbolt Lockouts .....	July, 13
Opening a Broken Lock .....	July, 16
Servicing Fox Police Locks .....	July, 17
Generating Chicago Double-Sided Keys .....	July, 42
Repairing a Stripped Plastic Safe Handle .....	July, 111
Non-Destructive Yale Retainer Removal .....	July, 149
Making a Trap Cylinder .....	Aug., 10
Recombining Profile-Type Cylinders .....	Aug., 12
Electric Gate Lock Service .....	Aug., 22
Staking B&S Retainers into Sidebar Locks .....	Sept., 11
Kwikset Double Cylinder Deadbolt Lockout .....	Sept., 14

Master Ring Cylinder Service...	Sept., 66
Opening Simplex Locks .....	Sept., 74
Bypass the Police Lock .....	Oct., 10
Broken Key Removal Tip .....	Oct., 12
Bommer Letterbox Service .....	Oct., 64
Simplex 3000 Key Bypass Lock .....	Nov., 13
Old Yale Removable Cores .....	Nov., 13
Servicing the Sargent 8-Line ...	Nov., 73
Trap Cylinder Explanation .....	Nov., 78
Pulling a File Cabinet Plug .....	Nov., 80
Modifying A Pinning Kit .....	Dec., 12
Tightening Corbin Rose Thimbles .....	Dec., 20
Rekeying Armalocks .....	Dec., 129
<b>Special Product Reviews</b>	
Electronic & Access Control Products .....	Feb., 64
New & Profitable Ideas .....	Mar., 27
Door Hardware .....	Apr., 32
Auto Security .....	May, 29
Show Stoppers .....	July, 71
Padlock Review .....	Aug., 28
Safe Information .....	Sept., 42
Key Machines on Parade .....	Oct., 38
Tool Review .....	Nov., 36
<b>Tips</b>	
Exhaust Provides Winter Heat Source .....	Feb., 12
Super Glue Dissolver .....	Mar., 13
A Spare Key Penknife .....	Apr., 12
Protecting Outdoor Locks .....	May, 12
Using Post-It-Notes .....	June, 14
Radiator Fan for Service Vehicles .....	Oct., 16
<b>Tools</b>	
Auto Plug Holding Vise .....	Jan., 12
GM Ignition Extractor .....	Feb., 10
Make A Drill Bit Gauge .....	Mar., 13
Pro-Lok Locksmith Tools .....	Mar., 32
High Tech Tools .....	Mar., 36
Credit Card Size Jimmy Tool ...	May, 12
Drill Sharpening Gauge .....	May, 15
Kwikset Cylinder Removal Tool .....	May, 15
Door Holding Wedge .....	June, 12
Floor Safe Installer .....	June, 12
Making a Piloting Pin Punch ...	July, 15
Fiberoptics by Olympus .....	July, 67
A New Digital Caliper .....	July, 105
Opening Tool for 87-88 Nissan Hardbody Trucks .....	Aug., 11
Custom Vise Jaw Adaptors ...	Aug., 14
Modify an Inexpensive Otoscope .....	Aug., 14
Lock Cylinder Shimming Jig ...	Oct., 10
MDS Safe Tools .....	Oct., 53
Making a Universal Plug Follower .....	Nov., 16
Lock Shim Holder .....	Dec., 10

It's your  
reputation.



Trust the  
original.

[Click here for more information](#)



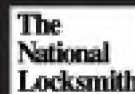
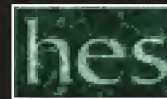

## The BiLock From Australia

“The BiLock cylinder is unusual in that there are no top pins, no master pins, and there is no shear line! The mechanism is enclosed in a half plug.”



Send your lock and key questions to Jack Roberts, The National Locksmith, 698 Bonded Parkway, Streamwood, IL 60107.

by Jack Roberts

Not long ago, the only *foreign* locks we encountered were those on foreign automobiles or motorcycles. Educational classes began to focus on foreign automotive lock service and the trend was to learn everything that we could about foreign cars. Key blank manufacturers were quick to jump on this bandwagon and a catalog from the

early 1960's shows 183 different blanks for 91 foreign-made automobiles with locks manufactured by Huf, Nieman, Bosch and many others.

Of particular interest, is that this catalog listed only five blanks for Japanese automobiles and showed no blanks for foreign locks other than automotive locks. The foreign automobile, however, was not the only type of foreign lock that was making the scene.

By comparison, a catalog from the late 70's shows more than 200 blanks for foreign-made locks and over 1300 blanks for foreign made vehicles. Locks and lock cylinders from around

the world started to appear and the challenges of service became more complex with each new arrival. We suddenly saw names like Fichet, Abloy, and a host of others and our duties started to become "international" in scope as we began to encounter locks and cylinders from just about every country in the world.

The latest key blank catalog, March 1988, shows more than 1500 blanks for over 200 different foreign brand names, not including foreign vehicles. Many of these locks and cylinders are of high security design and require special equipment for the origination or duplication of keys.



### ASP Covers the World of Auto Locks

[Click here for more information](#)



*Don't panic!  
We have  
Security Exit  
Devices.*

[Click here for more information](#)



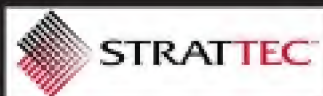
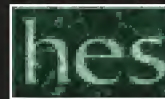

Now, from the continent of Australia, comes yet another cylinder of high security and unique design: the BiLock, "designed by locksmiths for locksmiths."

My first encounter with the BiLock was in 1986 at the ALOA Convention in Washington D.C. where \$1000 was offered to anyone who could pick a BiLock cylinder. The lines were long as some of the best "pickers" from around the world waited for a chance to have a go at the BiLock. After three days of effort, no one walked off with the money. I was intrigued with the design of the BiLock and at the Las Vegas Convention this year, I made a special effort to learn what I could about this unusual cylinder.

The key (see photograph 1), is the

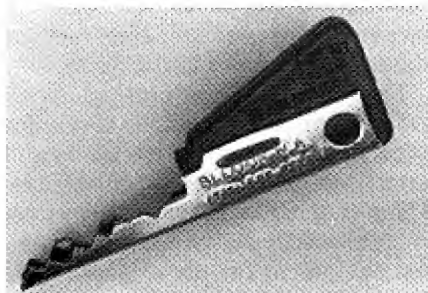

1. The BiLock key.

first thing that really catches the eye, and this is a blank that probably won't ever show up in the key blank catalogs. It might not be hard to produce, but the cutting and forming of the finished product requires some special equipment.

All BiLock systems are registered and the flow runs from the factory, in Torrance, CA, to a BiLock service center, to an authorized dealer, to a dealer. Key blanks are available from the factory only when an authorized dealer ID number is stamped into the blank before it is shipped. Keys may be cut only at the factory or at a BiLock service center. An *authorized dealer* may purchase unassembled cylinders and keys from the factory or a service center, may determine combinations, pin and assemble cylinders, but may not cut keys. A *dealer* may purchase assembled cylinders and cut keys from a service center or from the factory, but may not determine combinations, pin cylinders or cut keys.

The design and registration of a system for a dealer is controlled by a service center or by the factory. With this four level control it would seem that any system would be very well protected.

The key blank in its initial form before cutting has a 90 degree shape. (See illustration 2.) Each blade of the

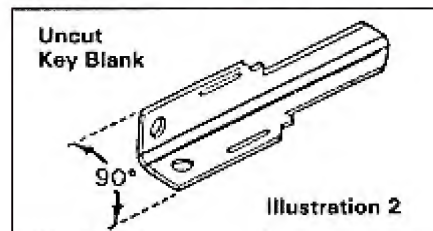

blank is cut separately, with a different combination, by a bench mounted clipper which automatically determines the correct spacing for each cut. (See illustration 3.) When both blades have

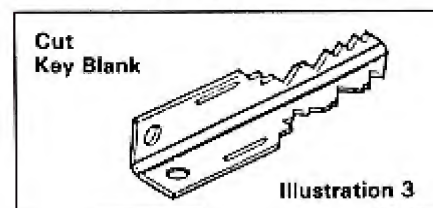

been cut with the proper combinations, the key is placed into a special forming press and bent into its unique "U" shape. The plastic head is then inserted into its groove and crimped firmly into place. (See illustration 4.) A DND notice appears on the head but I



**THE INNOVATION YOU EXPECT, WITH THE FLEXIBILITY YOU NEED!**

[Click here for more information](#)



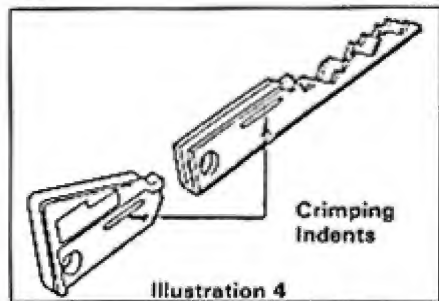
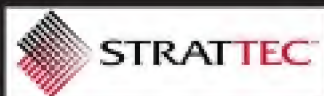

wonder about the need for this since duplication would be close to impossible without the proper equipment.

The BiLock cylinder is unusual in that there are *no* top pins, *no* master pins, and there is *no* shear line! The entire operating mechanism, pins, springs, spring cover (they call it a cap) and side bars are contained within a 1/2 plug, (see illustration 5) which, when the proper key is inserted, will turn freely within the cylinder. There are

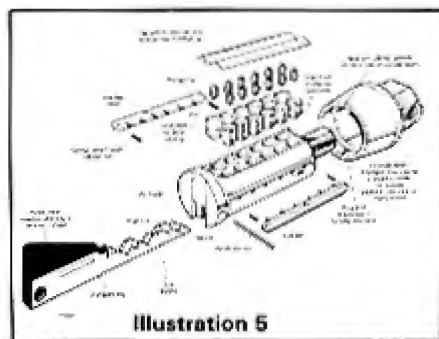

two rows of pins, six in a row, and two side bars. (See photographs 6 & 7.)

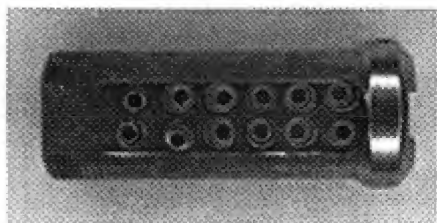

6. The two rows of pins...

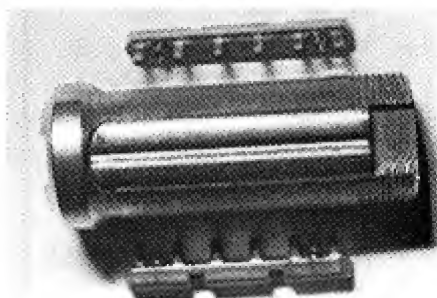

7...and two side bars found on the BiLock.

The pin tumblers and side bars are similar to Medeco in that there are holes in the pins to accept the shafts of the side bars and the pins are chisel pointed. The similarity to Medeco stops here, however, since there are



*HPC has it all:  
Key Machines, Software,  
Books, Car Openers, Pick  
Sets, Tools, Door Guards,  
and Key Cabinets*

[Click here for more information](#)





only 15 pin tumblers used in the BiLock System; four common pins, Numbers 1-4, and 11 master pins, Numbers 5-15. All pins are the same size (see photograph 8).

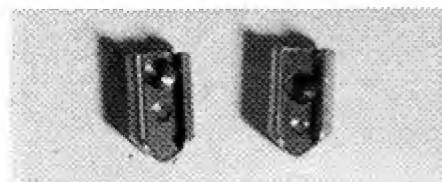

8. BiLock pins—all the same size.

The number of the pin is determined by the location and shape of the side bar shaft hole. The four common pins have a "dummy" hole, similar to Medeco, as an additional deterrent to picking. Each pin has a slot milled into the hole side in which the side bar shaft travels to keep the pin from rotating. With four depths of cut and twelve pin locations in each plug, the fifteen pins will yield about 16 million combinations. A fair batch for any system!

Resistance to drilling of the side bars is accomplished by the addition of hardened steel pins in the face of the plug. (See photograph 9.) The dual keyway (see photograph 10), and the construction of the key would seem virtually to

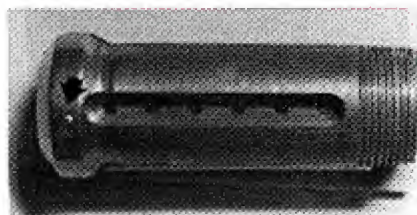

9. Steel pin found in plug face.

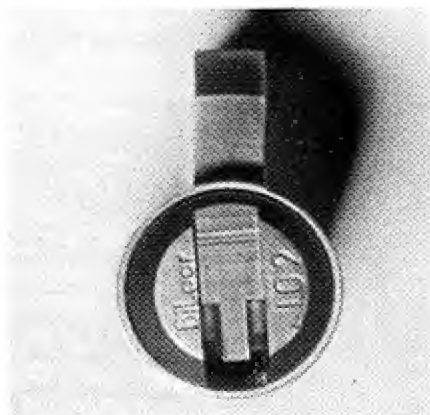

10. Dual keyway—protects against twisting.

eliminate the problem of keys breaking or twisting. Using a tensiometer we applied up to 45 pounds of torque to the head of the key several times with no apparent indication of twist.

It would appear that the BiLock design incorporates several ideas from other types of cylinders, (i.e., two rows of pins, side bars, side bar shaft holes, and hardened pins to deter drilling of the side bars), into a compact and easy to assemble package.

Advertising literature states that assembly can be accomplished in less than five minutes by a person with minimal experience. We were able to achieve this time frame easily after becoming familiar with the process and a half dozen attempts.

BiLock can furnish replacement cylinders for most any application or special design and offers two types of padlocks which are rekeyable and can be master keyed to any BiLock system.

Changes and challenges are inherent in our profession and constant education and updating of skills is a necessity if we are to stay a step ahead of the criminal element. Total system control appears to be possible with the BiLock design and factory to dealer arrangement.

Complete dealer information can be obtained from BiLock, 2420 Carson St., Suite 125, Torrance, CA, 90501, (213) 328-7030. ■



LOCKMASTERS  
SECURITY  
MANAGEMENT  
TM

Click here  
for more  
information

Providing  
quality tools,  
parts, and  
service for  
the security  
professional.



Every Installation  
Is a Self-Portrait  
Of the Person Who Did It.  
Autograph Your Work  
with Excellence.

Click here for more information



**medeco**<sup>®</sup>  
HIGH SECURITY LOCKS

**Integrity.  
Ingenuity...  
security  
solutions.**

[Click here for more information](#)

outlet, and didn't have Uncle Fester to plug into, but one of the guys did have a dandy little gas-powered Honda generator.

One good yank on the pull-starter was answered with a VROOOM! We were in business, and in photograph four, Downie is a-goin-for-it. In case it looks confusing, I should point out that this is a top-view photograph, taken by some nut standing on top of the safe, shouting encouragement to those brave souls on the front line. (Hey, once in a while it's fun being an armchair quarterback.) Anyway, I would be dragged into the game soon enough.

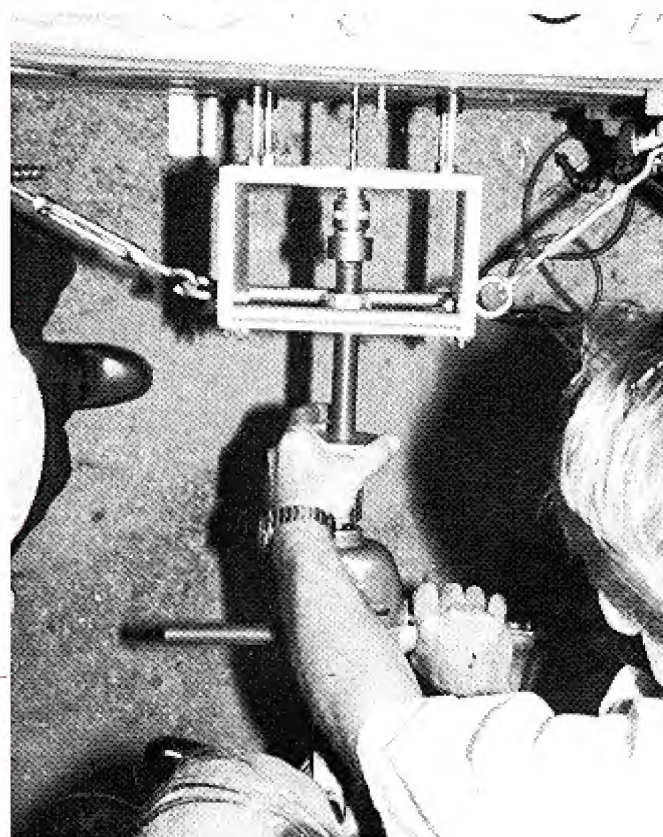

4. Drilling attempt, overhead view.

Penetration started off great. Mild steel for about an inch; copper for half an inch; and then the tough stuff. Everyone peeked in the hole and got a good look at the king of hardplates—Grade I Relsom. This is the most talked about and widely feared hardplate of all time, and for good reason. It tears up bit after bit.

We happened to be using B & A carbide tipped bits, which are of very good quality. Photograph five very clearly shows the consequences of climbing into the ring with Mr. Relsom. The bit on top is brand new; the bit on the bottom went one round and was KO'd. Understand however, that the brand does not matter. *Any* carbide bit, whether it be B & A, Z & Y,

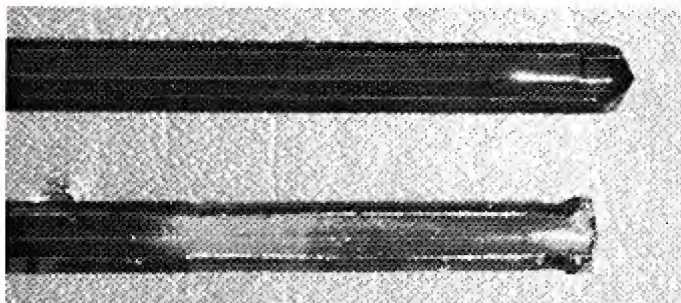

5. A normal carbide bit (top) and one used on Relsom (bottom).



## A Car Opening Trick

"This article will deal with general comments on car opening with a focus on one special tool and how I modified it to work on many different cars."



by Dale Libby

As strange as it may seem, I am a locksmith as well as a safecracker. I have been in both for about 30 years now, and my family was in the locksmithing and mail order key business since 1900.

An early emphasis of my locksmithing career was in automobile servicing,

foreign car key making, and lock repairs. This was at a time when foreign car work was a specialty and most information had to be gained from actual experience and from working in junkyards, pulling locks out of wrecked cars. I remember especially taking locks off Opel Kadettes (made in Germany) and being happy just to be able to get the lock off the steering column.

This article will deal with general comments on car opening with a focus on one special tool and how I modified it to work on many cars that it was not really made for. Perhaps these comments and ideas will be of benefit to

others also.

Nowadays, it seems that car opening is like the early days of safe opening. Before you can open a car, one must go to a car opening book to look up the year, model, number of doors, and possibly the color of the vehicle. Next, the book will tell you the color of the tool to use, where to put it, how to turn it, whether to push up or pull down or move to the side, or even to move it forward or backward in the door. Most of the time for modern car opening is spent in researching the many books and systems available to open specific cars. The actual opening takes only seconds.

**NATIONAL**  
AUTO LOCK SERVICE, INC.

**National Auto Lock Service, Inc. offers a wide range of equipment and services for the Automotive Locksmith. From tools and hard to find key blanks to transponder programming, we can take the mystery out of car service. We accept credit card orders, and can ship COD. Contact us for the latest in automotive technology.**

[www.laserkey.com](http://www.laserkey.com)



One of my favorite pastimes when called on to open cars is to try to be innovative, and try different methods, tools, and combinations of procedures. This, in the 1980's (soon to be the '90's) is quite necessary. For many years, the Slim Jim was the tool of need. Almost any car of the 1950's, 1960's, and the first part of the 1970's was able to be opened with this simple tool. In contrast now, except for some of the Chrysler line, the Slim Jim is used less because the movable pawl tailpiece is a thing of the past. There have been innovations to the Slim Jim, making it wider, longer, slotted, and hooked. All in all, it is a Slim Jim type tool, second or third generation. It is still useful, but it has fewer applications than it used to have in today's car opening arsenal of highly technological weapons.

There are several procedures that I use when I go out to open a car. The basic procedure I use is to look for the unlocking button or slide lever. If it is near the front of the car door, I will use the "J" tool as I call it, for it is shaped somewhat like a "J" if you use some imagination.

The first set of tools that I bought were HPC's Beretta-Tool and Caddy-

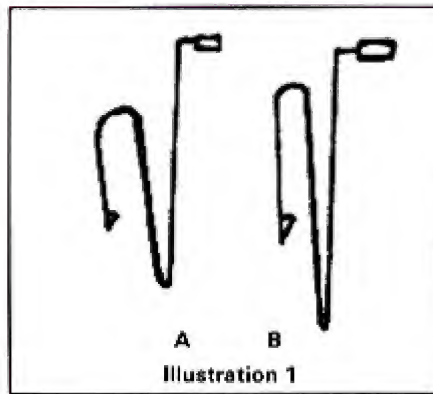

Killer. There are a couple of differences between these tools. Tool "A" as shown in illustration one is the Beretta-Tool, and "B," is the Caddy-Killer Tool "A" is wider and shorter than "B." The only thing that I look for when choosing either of these tools is if the door is wide with lots of padding, or thin and narrow. This is what determines what tool to use; not the name of the car that it is being used on. The wide tool cannot be used on thin doors, because the end of the tool will not contact the unlocking button. On the other hand, if you try to use the thin tool on a wide door, it cannot be pushed down without making the tool move away from the end of

the tool.

When I first got these tools, the theory for their use was new to me. The way in which these tools are used is very unique and different from most other car opening tools and methods. The door is wedged away from the window near the front of the car. The bottom is then inserted into the door between the window and glass. Once the top of the tool (the upper curved portion) is below the window, it is then turned so that the top of the tool goes under the window and up on the other side of the glass, actually inside of the car. To facilitate this, sometimes it is necessary to remove the outside wedge to take off pressure on the inside window against the inside of the door. The tool can then be raised up to allow the end of the tool to go over the inside trim of the door.

The tool is then lowered to the area of the contact button, slide, or in the case of Ford products, the opening handle. The tool is maneuvered into position and either the button is pressed, pulled, slid, or depressed, and the door is unlocked. When I first used these tools, they worked quite well. I had no problems, and I got a little



*Choose S&G Comptronic  
electronic safe locks for...security...  
technology...tradition.*

[Click here for more information](#)



**Free  
freight!!**

**No middle  
man!!**

[Click here for more information](#)



overconfident.

A dealership called me to open a 1988 Buick Regal with the new type pull door handles. Since I had done a couple doors of this type before, I approached the car with confidence. Unfortunately after inserting the wide tool into the door, and locating the unlocking flipper, I found to my surprise that the tool was too short, by at least  $\frac{1}{4}$ ". No matter how I tried, I could not get that tool down enough to reach anything important. What is worse, I could not get the tool out of the door. The rubber edge molding on the inside of the window prevented me from taking the tool out of the door.

I then proceeded to insert the Caddy Killer into the door enough to push back the inner strip, and get the original tool out of the door. I did not pull the Caddy Killer all the way into the door above the weather stripping, so it was easy to remove.

There were several salesmen watching me while I was extracting my first tool from the door with the second tool. They were having a good laugh at this; the locksmith that was stumped and could not get a car open.

Now in illustration two, on the left is

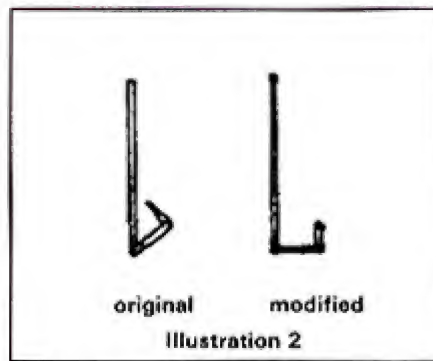

the original end of the tool as it came from the factory. The tool was curved back into the shape of a triangle. This allowed the end of the tool to slip over the edge of the door cover plate that is around all the unlocking and sliding buttons mounted on the edge of the door. This works quite well, and I could use the extra length in the tool curvature if I straightened it out.

I heated the tool with a small propane torch and when the metal was hot enough, I bent it into the shape on the right; that of a short "L" with an upward small end. While I was at it, I heated up the Caddy-Killer and made similar bends in it also. The purpose of the bend was so that if possible, I could

hook door handles too if need be.

I went back to the car with my modified rebent tool that was now long enough to activate the unlocking button with about  $\frac{1}{4}$ " to spare. Since that time, I have not met a car or truck that I have not been able to open when I deemed it necessary to use these tools. In the modified state, they are always long enough on all the openings that I use them on.

At first, I started using these tools when all of the proper tools for the job were not working. These were my last ditch effort when-all-else-fails tools. And they always worked. Suddenly, the concept of using these tools as a first line of offensive attack started to make more and more sense to me.

Now I use these tools before I use others. I use these tools on all cars with flipper (flapper) type locks, including the S-10 and the larger Chevy Blazers. I can use these tools on Ford Ranger pick-up trucks. The inside handle can be lifted enough from the inside edge of the door outwards to raise the inside button.

Although special tools are made for slide lock cars which work quite well, sometimes I like to see exactly what I

*Continued on page 132*

**SRI**  
SECURITY  
RESOURCES INC.

**SRI AND TECH TRAIN PRODUCTIONS ARE  
THE AUTOMOTIVE SPECIALISTS - YOUR BEST  
SOURCE FOR AUTOMOTIVE TOOLS,  
MANUALS, AND VIDEOS.**

[Click here for more information](#)



# Shop Talk

Helpful Questions and Answers

Written by *all* of the following authors: Don O'Shall, Dale Libby, Shirl Schamp, Robert Sieveking, Jack Roberts, Steve Spiwak, and Dave McOmie.

Send your locksmith questions, along with a self-addressed stamped envelope to: Shop Talk, *The National Locksmith*, 698 Bonded Pkwy., Streamwood, IL 60107.

*Q: I need a suggestion or solution for making a key for a GM trunk, when the glove box is locked and it has a side bar, other than removing the door lock which is time consuming.*

A: The type of glove compartment lock which you describe is most commonly found in the General Motors luxury cars such as Cadillacs. This type of slide lock features a standard complement of six disc tumblers in the familiar side bar arrangement.

Attacking this lock can be done in one of two ways. The first method would be most desirable for those locksmiths who are adept at picking. General Motors picking tools are available and when properly utilized will open this type of glove compartment without damage. The second procedure is the one which I favor. Generally I have great success in drilling these locks.

The drilling procedure is easy.

Simply drill a 9/64" hole just above the point where the side bar can be accessed by a sharp ice pick or awl. After drilling the hole, carefully insert the ice pick in order to depress the side bar. Once pressure can be applied to the side bar the General Motors side bar disc tumbler can be easily picked and the glove compartment opened. *Note:* Any standard filler which hardens on contact with air can be used to fill the hole which you just drilled.

Once the cylinder is removed, the lock can be serviced in two ways. First, pick the lock to the open position while holding the side bar. Then simply use any standard decoder to decode the cuts in order to make a key. Your second option is to disassemble the

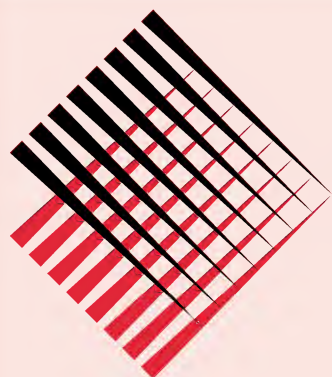

## STRATTEC™

***The world's largest producer of  
automotive locks and keys.***

[Click here for more information](#)





## ASP - Your Auto Service Center for the World

[Click here for more information](#)

cylinder, read the tumblers, make a key and reassemble. 01

\*\*\*\*\*

*Q: We operate a busy shop and road service business. Twice in the past month we've run into complications after letting someone into "their" house. They have current ID with that address. We later find that we have let an old girlfriend, ex-roommate, ex-spouse etc. into the property.*

*As a general rule, we check the name and address on the driver's license to see if it corresponds. These have proven many times to be bogus in cases such as a previous owner, tenant, divorce, and in the case of new home owners who have not yet changed address on their ID but invariably lock themselves out. In some cases we trust that gut feeling, ask the neighbor for verification, ask for them to locate keys in the house...but what are our legal responsibilities? Are forms like an authorization form enough? Any discussion would be appreciated.*

*James Tinder  
Indiana*

*A: The question that you have posed is the one that keeps most locksmiths up nights who do service calls. The best advice that I can give you will be based on my own experience and advice from my attorney. However, before you attempt to do any service calls where the identity and motives of the customer are suspect, consult your own attorney.*

*Probably the most important concept to be considered in such cases is the idea of "due care." Generally speaking, this term refers to the sincere attempts on the part of the locksmith to do everything reasonable to verify the identity of the person asking for a key to his home or car. In fact, less due care is required in emergency situations where the customer is asking the locksmith to free a child from a closed auto on a hot day or from a refrigerator. If due care is taken and the locksmith is satisfied as to the valid identity of the customer and his right to have a key made for his auto or home, then the locksmith should proceed. Remember, that in the final analysis anyone can be sued. The person doing the suing doesn't have to be right and the one being sued doesn't have to be wrong. The experience of going through the law suit can be unnerving enough even if you win.*

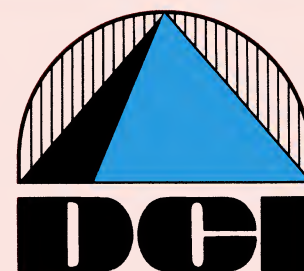

## We have it all.

## Quality, Value, & Service.

[Click here for more information](#)





## The Innovation You Expect, with the Flexibility You Need!

[Click here for more information](#)

We also use an authorization form on service calls where we face similar uncertainties. This form alone, however, cannot protect the locksmith from potential liability resulting from his actions. We ourselves have never experienced any legal fall out from these service calls because of one hard and fast rule which we always follow. If the serviceman has any doubt about this situation and the prospective customer's identity, then the locksmith has only two choices. First, require a police officer to be present at the scene or second, walk away from the service call.

Being in the state of Illinois we have a greater problem dealing with automotive work than those locksmiths in such states as California for example, where all drivers are required to carry registration, etc. In Illinois such papers beyond a driver's license alone does not identify the owner of a particular car. Even if the locksmith had the ability to run the license plates through the department of motor vehicles, this would still be inadequate information, such as in cases of a leased car where the dealer's name and not the leasee's is on the registration as owner.

The question you have posed is often impossible to answer, difficult at best! Just remember to exercise good judgment in these sticky situations at all times, request a law enforcement official whenever possible, and if worst comes to worst, don't be afraid to walk away from a service call of this nature if it makes you that uncomfortable. 01

\*\*\*\*\*

*Q: I have a job to rekey the locks in a shopping center. The doors look like the kind that have Adams-Rite locks but these locks are Armalock. The bolt is in two parts, like a telescope; one part extends out of the other part. I have taken the retainer screws out but the cylinders will not unscrew. It looks like there is a wire or something that could be holding them in. How can I get the cylinders out? Where can I get new cylinders? I messed one of them up with a pipe wrench trying to get it out. This is a big job for me. There are six doors with two cylinders on each door. Any help you can give me will be helpful.*

*A: Well, the first thing you need to do is get rid of the pipe wrench. This is not the type of tool that is normally found in a locksmith's tool box.*

You locate the secret of cylinder



## HPC, Inc. Designing Excellence and Manufacturing Quality since 1956

[Click here for more information](#)



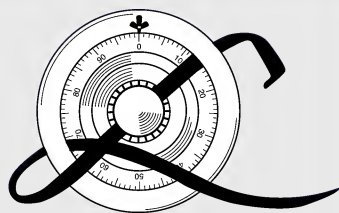

Lockmasters  
has a  
44 year  
history of  
training  
security  
professionals.

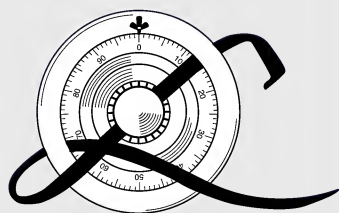

[Click here for more information](#)

removal from Armalock locks when you saw the wires—you just didn't explore far enough. Those wires are spring clips, sort of like an auto lock retainer clip. Just pull them out and the cylinders will slip right out of the lock.

These locks will also accommodate a screw type mortise cylinder. You will be able to see the threads when you remove the cylinders. If you have to replace the damaged cylinder you can use a one inch mortise cylinder with a Yale type of cam. You will have to file the end of the cam about 1/16" in order for it to operate the Armalock mechanism. Be careful with your filing. If you take too much off it won't throw the bolt. Just file and try until you get it operating smoothly.

Thanks for writing to Shop Talk and do get rid of the pipe wrench. 03

\*\*\*\*\*

*Q: Help! I have to take the lock out of a 1978 Chevy steering wheel. My puller won't work on this one like it always has; it slips off the lock. I tried a slam hammer but it won't work either. I read where there is a retainer that you can push after you take the wheel off but I can't find it. Please send an answer quick—the fellow needs to use his car.*

**A:** The puller you have is only effective on GM automobiles up to 1976. The design of the lock was changed for the 1977 and later models although there may be a few '77 cars with the older locks. If you will examine a pre '77 lock and a post '77 lock you will see that there is a difference in the way the "ears" are attached. On the older locks you could remove the ears, pull the lock, service it, and replace the ears. There is a puller designed for the newer type, but it is hardly worth the time and effort to use.

You really should get rid of your puller since this is the type of tool used by a thief or a repo man—not by a professional locksmith. And, also get rid of the slam hammer. You could do some real damage to the column housing which could cost a bundle to replace. Attend a class on steering column lock removal or purchase a book and study the procedures. You almost have this one whipped and I will try to tell you how to proceed.

I'll have to assume that you have removed the wheel and the turn signal mechanism. If this is correct, look

**Major**  
ANUFACTURING, INC.

Installation

Tools

The

Professionals

Choice

**Major**  
ANUFACTURING, INC.

[Click here for more information](#)



**medeco**<sup>®</sup>  
HIGH SECURITY LOCKS

**The market  
leader in  
locking systems  
for security,  
safety, and  
control.**

[Click here for more information](#)

**NATIONAL**  
AUTO LOCK SERVICE, INC.

**National Auto Lock Service, Inc. offers a wide range of equipment and services for the Automotive Locksmith. From tools and hard to find key blanks to transponder programming, we can take the mystery out of car service. We accept credit card orders, and can ship COD. Contact us for the latest in automotive technology.**

[www.laserkey.com](http://www.laserkey.com)

closely at the casting of the wheel housing about one inch from the steering shaft in about the one o'clock position. There is a slot in the casting which normally would reveal the black retainer on the rear of the lock body. Sometimes this slot is not all the way through the casting and you will have to break through it with the tip of a small screwdriver.

When you have broken through this thin casting membrane you will see the retainer and can feel it's spring action when you push on it. Push on the retainer and pull the lock out of the housing. If you have trouble locating this slot, take a new lock and hold it in an approximate position in relation to the assembly and you will be able to see about where the slot is located. Insert a new lock and check for proper operation before you reassemble the turn signal mechanism and replace the wheel.

When you get the fellow up and running take the money he gives you and apply it towards the purchase of a good book. Or, if you have a VCR I would recommend the GM Steering Column Video from *The National Locksmith*. It covers all GM columns to date including tilt-wheel, telescoping and the beretta.

Thanks for writing to Shop Talk and I hope we have been able to help. 03

\*\*\*\*\*

In the October *Shop Talk* Delphina Borley wrote in with a photo of a sliding glass door lock she was unable to identify. (See photograph 1.) A

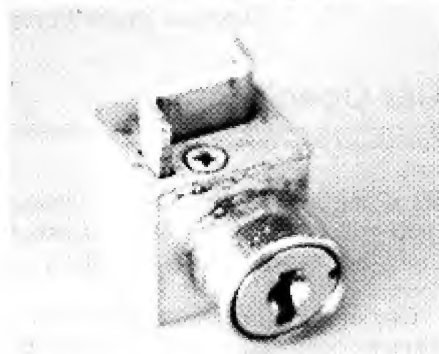

1. Sliding glass door lock submitted for identification.

number of people have contacted us to identify the lock. Art Tessin of Grayling, MI was the first person to call *Shop Talk* with the answer.

Most of the votes were for the following company as the manufacturer: Garcy Corp., 1000 Garcy Blvd., Nance Creek Industrial Park, Pied-



**Make Sargent &  
Greenleaf's  
Comptronic locks  
your choice for  
electronic safe  
locking solutions.**

[Click here for more information](#)

**SCHWAB CORP.**  
*Fire protection for your vital records.*

***It's not safe  
unless it's  
Schwab Safe.***

[Click here for more information](#)





SRI and  
Tech Train  
Productions  
are the  
automotive  
specialists -  
your best  
source for  
automotive  
tools,  
manuals,  
and videos.

[Click here for more information](#)

mont, AL 36272. Their phone is (205) 447-9016. Art says the lock uses a Chicago blank. Garcy's part number for the key is #2456. Thanks for all the help, guys! ■

### Letters

*Continued from page 6*

opened locked doors for people as a public service. This practice interferes with my business and I object to it. They are no more locksmiths than I am a policeman. I do not attempt to do their job and I would appreciate it if they would not attempt to do mine.

I certainly have no objections to officers using whatever means are necessary in an emergency, but when an officer does my job, he is not available for his proper duties. I would also like to point out that because the officers are not trained, they risk causing damage for which the department may be liable. I am a fully licensed locksmith who is qualified, trained and insured and I would appreciate being treated as such.

Please instruct your police officers not to perform my job.

Gilbert Fletcher  
Ontario

**Reply:** You will be pleased to know that effective this date, officers will only open locked cars under emergency situations (e.i.: child locked in car).

In the past, this service was provided to reinforce good public relations, but in this age of electronic door locks and other complicated systems, I find it no longer practical to do so.

Lewis Lawson  
Chief of Police  
Stratford Police Force

### Car Opening

*Continued from page 124*

am doing while I am doing it. These tools will not take the place of other tools, but can be used in addition to them.

One of the other challenges we face when we open cars is having to work on cars that other well-meaning good Samaritans have tried to open. The Slim Jim attack on cars that cannot be "Jimmied" is an ever popular event, with the resulting disconnected linkages and lost clips.

Now whenever I go out on a job, I always *assume* that some person has tried to pry and scratch up the door with almost anything imaginable that can be found around a locked car. ■



The world's  
largest  
producer of  
automotive  
locks and keys.

[Click here for more information](#)