

December 1991

# The National Locksmith®

1992

LOCKSMITH

DIRECTORY

Inside This Issue

*Industry Directory Listings \* The Lighter Side  
Technitips \* Safe Lock Service \* And More!*



# Contents

## Features

**22** Manufacturers

**82** Distributors

**120** Schools

**122** Alarm Monitoring

**124** Miscellaneous

**125** Representatives

**130** Associations

**138** Corbin Russwin  
Uniloc

Jack Roberts gives us his methods of servicing these new heavy duty locks. Read on!

**142** U.S.  
Security Safe

Here's Dale Libby's article on how to service safes made by this company, both old and new style.

**158** The Lighter  
Side

Take a few minutes to laugh along with Sara Probasco as she writes about the locksmith dress code.

*Click on the article  
you wish to read*

The  
National  
Locksmith

December 1991

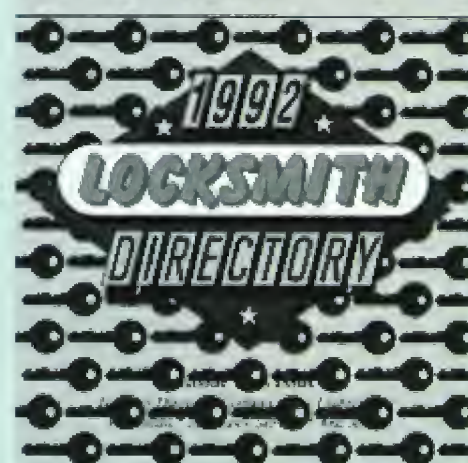

### On The Cover

This month's issue brings a comprehensive guide to the companies in the locksmith industry. This is certainly an issue you will want to save for reference all during 1992.

## Departments

5 Commentary 6 Letters 9 Technitips 16 Newsmakers

**Editor/Publisher** Marc Goldberg  
**Managing Editor** Sandy Kucharski  
**Circulation Manager** Tracey Brady  
**Technical Editor** Robert Sieveking  
**Technical Writers** Carl Cloud, Eugene Gentry, E. Lee Griggs, Ed Hill, Dale Libby, Joseph Locke, Regis McCafferty, Dave McOmie, Rick Ohmit, Don O'Shall, Sara Probasco, Jack Roberts, Shiril Schamp  
**Advertising Sales Mgr.** Thomas Miodoch  
**Advertising Sales Asst.** Debbie Schertzing  
**Advisory Board** Keith Levine, Mike Elsberry, Steve Dyson, Buddy Logan, Sean DeForrest

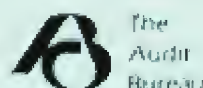

### The National Publishing Company

**The National Locksmith®** ISSN #0364-3719 is published monthly by the National Publishing Company, 1533 Burgundy Pkwy., Streamwood, IL 60107. Phone: 708-837-2044. FAX 708-837-1210. Second class postage paid at Bartlett, IL 60107 and additional mailing offices USPS 040110. Subscriptions \$32.00 per year in the USA; \$34.00 per year in Canada, \$37.00 in all other countries. Single copies \$4.00 each. Postmaster, please send change of address to National Publishing Co., 1533 Burgundy Pkwy., Streamwood, IL 60107.

©1991 by The National Publishing Company. All rights Reserved.

Printed in the U.S.A.

The National Locksmith does not necessarily endorse products or services advertised.

# Commentary

Happy Holidays!

Here we are with the holiday season close upon us. Times have been tough for many people during the last year or so. When I first started reading about the recession, the media kept repeating over and over that our economy was slipping. Now that recession has certainly walked among us, the media constantly reports that the recession may not soon be lifting.

I am beginning to wonder about the media. Oh, I do not deny that there is an economic slowdown. I just wonder what effect the reporting has on the confidence of the American people. If all we read about is rough times, then when will people develop the confidence they need to begin buying again?

I think there is reason to be optimistic despite the current difficulties. Right now, interest rates are at the lowest they have been for many, many years. Today you can purchase a house and receive a mortgage rate much lower than you could have gotten twelve to fifteen years ago. The same holds true for car loans.

Well, people have slowed down their purchases of automobiles, houses and other big ticket items. But as time marches on, their cars continue to grow older. And people still are making babies, increasing the need to move into larger homes.

I don't know when it is going to happen, but I believe we will eventually spring forward out of this recession. As the housing and automotive markets rebound, so will the rest of the economy. I believe that the locksmithing industry is closely tied to the housing industry. When more homes and buildings are built and sold, your own economy will also improve. Remember, there is a lot of pent up demand for products and services out there.

What does all this mean to the average locksmith? It means hard work during the coming months. There is still money out there on the street. But trust me, the money is not simply going to waltz into your shop or van and plop itself down on your counter. You must aggressively get out on the street and look for the business. There is an old saying that goes, "Good things come to those who wait." We should revise that saying to read, "Good things come to those who ask for them."

I have a number of friends who operate small businesses. Some are locksmiths, others are printers, others are sign makers. One of the big similarities I am noticing among them

is that those business people who leave the office and call on potential customers are doing more business than those who stand behind the counter waiting for the phone to ring. You *can* help your business grow, even during slow times. All you have to do is work harder and smarter than the competition.

Some of your competitors might try to obtain more business by cutting their rates. Those are the people who will find it hard to remain in business over the long haul. Do a good job at fair rates and treat the customer right. These are the secrets to enjoying a long, healthy career.

Get out there and visit your commercial accounts. If you desire to build more such accounts, go call on companies, leaving them an informative brochure on the services and products you offer. Many of my locksmith friends who have employed this strategy report to me that they are increasing their workload, and their profits as well.

At this time of the year I want to wish each of you a happy, safe and healthy holiday season. As we look back over the past year, we must all realize that there is, indeed, much to give thanks for!



*Marc Goldberg*  
Editor/Publisher

December 5



# Letters

## Comments, Suggestions and Criticisms

*The National Locksmith is interested in your view. We do reserve the right to edit for clarity and length. Please address your comments, praise, or criticism to Editor, The National Locksmith, 1533 Burgundy Parkway, Streamwood, IL 60107. All letters to the editor must be signed.*

### There Still Are Some Honest People Left

Dear Marc:

I was called out on a car lockout yesterday. The car, which was a Ford Taurus, was out of the little town of Sierraville, about 40 miles from my shop in Truckee, CA. I told my son to take his motorcycle and pick set and go open the car. My son has the new look hairdo, long in the back. The man was standing by his car when this young kid with long hair, shorts and helmet, pulled up by his car, way out in the boondocks, and said to the gentleman, is this your car. The man looked puzzled and afraid to say yes. My son said I am here to open it up for you. After some hesitation and stuttering, he said are you the locksmith from Truckee? He said yes, and took out his pick set and was in the car in 30 seconds.

Now after driving all that way the man only had \$43.00 of the \$65.00 quoted. To my amazement the man just walked in my shop and paid the balance of his bill. Who said there were no honest people left?

He also remarked, how strange it was to have a locksmith pull up on a motorcycle.

Jim Alford  
California

*Editor's Note: Speaking of motorcycles, Stewart Johnson from Locksmith Supply Co. of Australia once told me about one of his locksmith*

*customer's in that country. The locksmith uses a motorcycle as his service vehicle, and has mounted a portable key machine on the rear fender!*

*If any other locksmith's use an unusual vehicle for locksmith service, how about sending me a photograph and a description so we can show everyone else.*

### Illinois Locksmiths Assn. Alive and Well

Dear Marc:

This is to advise your reader's that the Illinois Locksmith's Association meets the first Sunday of each month at the Holiday Inn in Carlinville, Illinois. We would appreciate it if you could publish this information for a few months in *The National Locksmith* magazine and give us a hand with informing your readers that we are alive and well. We are trying to rebuild our membership and could use a little help in getting the word out.

Also, this letter will serve to advise you that as of January 1, 1992, the newly elected president of the Illinois Locksmith's Association is Joseph W. Stevens, of Joe's Key and Lock Service, Marissa, Illinois. Phone number is (618) 295-3415. Please list as Joe as the contact for our Association. Joe is an ALOA and SAVTA member, belongs to the Guild, Tru Center and Keysquares. Joe is also a long time subscriber to *The National Locksmith*.

Joseph Stevens  
Recording Secretary

### A Few of My Favorite Comments

Dear Marc:

Last week my uncle's brother from out of town stopped by my store. He

said he was looking for something to invest in, and wanted to know if I would teach his son the locksmith business. He figured two or three days out to be enough to get started. I told him, it might be long enough to learn how to install deadbolts.

"What about one of those locksmith courses I've read about?" he asked. I told him that a few months of hard studying may give you the basics, and is a good way to start, but there is always more to learn. Apprenticeship is helpful.

He felt I was being hard nosed and really didn't want to be bothered. After 20 years in business, I believe the general public's impression of a locksmith is someone who can drill a hole and turn a screw. Granted there are those who see our talent and respect our knowledge, but the average person who uses our services for the first time comes out with these statements:

"What a racket. How much?"

"I'll break the window first."

"There's a guy in the Pen (or down the street) that can do that in 5 seconds."

"That much for a 5¢ key?"

"The whole car's not worth that much."

"No one has played with it before you got here."

"I've been using locks for years and never had this problem before."

"It worked fine yesterday. Why did it break now?"

"It's been acting funny for a while, why doesn't it work now?"

"If you just hit it, it works fine. Now it's broke. Why?"

"I've been driving cars for years, don't tell me it cost that much or that I didn't take care of it."

Here are more favorites in order, I arrive on the job site and they say: 1) "I called the other locksmiths and the one

*Continued on page 160*



# Technitips

Helpful Hints from Fellow Locksmiths



Send me your Technitips. Who knows, you may be our next winner! c/o The National Locksmith, 1533 Burgundy Parkway, Streamwood, IL 60107.

by Robert Sieveking

*Congratulations to all those that find their Technitips printed here this month. Thank you for sharing your best ideas and newest discoveries. The Tips you see this month are the last that will be eligible for the 1991 Technitips Contest. This year's winners will be announced next month. Will your name be found among the winners? Awards for excellence will always go to those individuals that are willing to "do just a little bit more than others expect," or "hold themselves to a higher standard than others are willing to acknowledge." It is the quality of their work that makes them winners, whether they are writing a Technitip, pinning a lock, or making a key with a hand file. Their commitment to quality makes*

### Win a VATS Decoder From All-Lock!

Each month, All-Lock will award one of their A-7000 VATS Decoders and an A-7001 Adaptor to the best automotive Technitip submitted this month. If you would like a chance to win a free decoder and adaptor from All-Lock, simply submit your automotive tip exclusively to *The National Locksmith*. Tips submitted to other publications cannot be considered.

All-Lock's A-7000 makes it easy to diagnose system failures, service the column and select the correct key blank. This sophisticated tool is easy to use and is completely portable. Long wire leads are easy to use in cramped automotive situations.

Submit your tip, and win today!



*them winners. That is why they will succeed in business, always have work, and even win an occasional Technitips contest.*

*As we enter this holiday season, let us reflect on the freedoms we enjoy and give thanks for the blessings we have received. Let us renew our commitment to excellence and resolve to give our*

*customers just a little bit more than they expect, by holding our standard of quality just a little higher than the competition.*

*Yes Sir, No Ma'am, and Thank you very much for your business. Fortunes have been made with good manners, and lost through a careless word.*

### How To Enter

All you need to do to enter is submit a tip, covering any aspect of locksmithing to *The National Locksmith*. Certainly, you have a favorite way of doing things that you'd like to share with other locksmiths. Why not write it down and submit it to: Robert Sieveking, Technitips' Editor, *The National Locksmith*, 1533 Burgundy Parkway, Streamwood, IL 60107.

Tips submitted to other industry publications will **not be eligible!** So get busy and send in your tips today. You may win cash, merchandise, or even one of many key machines or code book sets! At the end of the year, we choose the winners of the listed prizes.

Last year dozens of people walked off with money and prizes. Wouldn't you like to be one of the prize winners for 1991? Enter today! It's a lot easier than you think!

### Every Tip Wins 'Locksmith Bucks!'

Yes, every tip published wins a prize. But remember, you must submit your tip to *The National Locksmith* exclusively. Each and every tip published in Technitips wins you \$25.00 in Locksmith Bucks! Use this spendable cash toward the purchase of any books or merchandise from *The National Locksmith*. You also receive a Bonded Locksmith bumper sticker and decal. Plus you are now eligible for the really big prizes!

### Best Tip of the month prizes!

If your tip is chosen as the best tip of the month, you will win \$50.00 in cash as well as \$35.00 in Locksmith Bucks! Plus you will receive a quartz Locksmith watch, a Bonded Locksmith bumper sticker, decal and a Locksmith Cap. Plus, you may win one of the annual prizes.



### December's Best Tip

The Vanguard VS-70 fire safe is sold by Sears, and is manufactured by Center Manufacturing Company, Inc. of Belvue, Ohio. This safe has a three wheel combination lock that is made of a plastic material that wears out very easily. The worn lock parts wear and slip, causing a lockout. Solving the lockout is the subject of

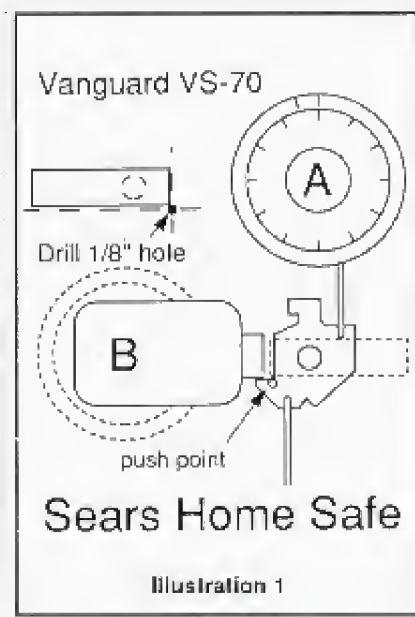

this Technitip.

To open this safe, use a standard 1/8" drill to penetrate the safe at the bottom right corner of the opening handle. There is at least 1/4" of play, either side of this point, which allow this Tip to work if you are slightly off in your drilling. It is however important that your hole be straight into the door, and not angled, as you will be using the hole to punch back the bolt cam. Drill straight in as you see in illustration one-A.

You will be drilling through the outside skin, some insulation material, and the inside skin of the door. As the drill passes through the inside skin, you will feel a "flexible restriction." This will be the handle cam. Do not drill through it. You should be able to feel the vibration of the drill through the opening handle, as the drill touches the handle cam. The drill should contact the handle cam as you see in illustration one-B. Push on the drill (without rotation) or use a solid 1/8" rod to apply pressure, as you apply turning tension to the opening handle. The idea is to push the cam plate back far

enough to bypass the lock bolt. Rotating the handle will retract the door bolts and allow the safe to be opened.

There is no need to use a hammer, as the cam plate can be distorted far enough with hand pressure, to bypass the lock bolt. Repair the hole with a machine screw from the inside of the safe. Cut and grind the tip of the screw flush with the face of the door to complete the repair. Replace the lock mechanism with a quality replacement, as it is not economically repairable.

These safes are advertised in the new Sears catalog. I have serviced a number of them since June. The above method makes opening and repair a very simple procedure.

H.L. Whiteford  
California

\*\*\*\*\*

### Automotive Tip of the Month

This tip is the winner of the All-Lock A-7000 VATS Decoder and the A7001 Adapter. All-Lock will award this package to the best automotive

*Continued on page 12*

# Major

## MANUFACTURING, INC.

### *Installation Tools*

### *The Professionals Choice*

[Click here for more information](#)



Continued from page 10  
tip each month of the year.

Here is a Technitip for an easy and "almost" damage-proof way to remove the tailpiece from the new Pontiac LeMans trunk and door lock cylinders.

Place a small screwdriver between the plastic tailpiece and the metal retaining cap, more as a wedge than a pry. *Do not pry the tailpiece.* As the screwdriver is inserted, it will wedge the plastic tailpiece away from the metal cap slightly, placing a strain on the retainer. At this point, use a pointed tool to press in and compress the retainer. Compress the retainer at intervals around the shaft, while retaining the pressure with the "wedge" screwdriver. The retainer will be forced into the groove in the shaft, and held captive by the cap, as it is wedged up the shaft. Once or twice around the retainer will usually find the tailpiece free to be removed without damage.

Use a little more patience and a little less force on these unusually difficult locks. They will come apart without damage if you're careful.

William E. Knuckles  
Kentucky

\*\*\*\*\*

With the recent interest in "self recombining" pin tumbler cylinders, I have enclosed a copy of my grandfather's trick, which he patented back in 1959. The patent, and therefore patentability of the idea has expired, bringing it into the Public Domain, so anyone who wants to can use it. I'm sure you will find the concept interesting. I use it on jobs for master keying clients who ask for multiple rekeyings, such as franchise operations that change managers a lot and apartment complexes that change tenants frequently.

The primary advantage of this method, over most others is in that the master wafer, after it has been removed from the pin stack, is "ejected" from the cylinder by the change key. This eliminates the need to modify the spine or back side of all subsequent keys to the cylinder. This also completely eliminates the possibility of the master wafer becoming jammed between the plug and shell of the cylinder.

Illustration two shows how this idea works. Key #1 is shown in the working position. The master wafers are carried in the plug. Key #2 is a changing key. Note that the first master wafer is elevated above the shear line, and into the upper pin chamber. A notch, at the

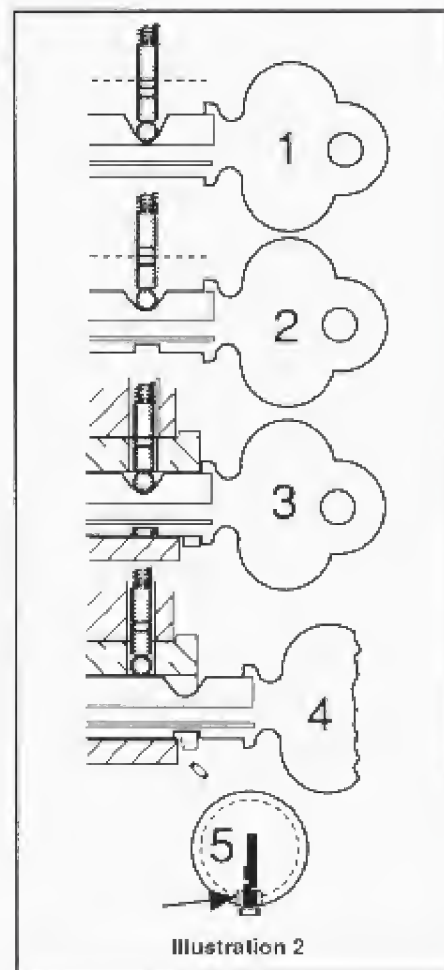

Illustration 2

Continued on page 14

## MORE IMPROVEMENTS

**on the Remote Starter Systems that all others are compared to.**

### GUARANTEED SATISFACTION

If you are not 100% satisfied, return our product within 60 days for a full refund of purchase price.

The benefit of new technology means big savings to you. **DIRECT TO DEALERS. NO REPS.**

**CALL 1-800-346-0999**



SINCE 1983, THE LEADER AND PIONEER IN REMOTE AUTO STARTING.

# C&A Control Systems, Inc.

7117 Commercial Park Drive, Knoxville, TN 37918, (615) 922-2148

Made in U.S.A. Patents Issued and Pending.



proper position on the back of the changing key will when the key is rotated accept and trap the master wafer at the bottom of the keyway. So far, this is basically the same as most self change cylinders. Where this Technitip is different is in the bottom of the keyway.

The bottom of the plug has been modified, over its length, to allow the wafer to be slid forward and out of the keyway as you see at #4. The master wafer is ejected from the cylinder as the key is removed. Because the plug of the cylinder has been "slotted" over its length, as you see in #5, it is possible to remove a master wafer from any pin

chamber. This allows for more flexibility where the keying is being changed. Multiple key changes are possible, even to the possibility of removing more than one master wafer at a time.

By keeping simple records of the cylinder keying, you will be able to make a changing key in the shop, for use in an after hours emergency situation. The notched changing or work key is *never* given to a customer.

This Tip will work on most keyways, with very few exceptions. As with all "master keying," you must remember that as you add master wafers you decrease the security of the

cylinder. More master wafers will mean less pick resistance and more possibility of phantom keys operating the cylinder. This tip is a convenience method, as a master system is a system of "convenience." You, as a locksmith must weigh the "convenience" against the "security," when suggesting or installing this cylinder. Never master all positions of a cylinder.

Robert Morrison  
Pennsylvania

\*\*\*\*\*

We recently purchased a locksmith shop and we have been trying to think of new ways to build our repeat business. We found that most people go to other places in town to have keys made, and only come to the locksmith as a last resort. For this reason, we decided to start a key club for our walk in customers. This Technitip is a way to increase your key trade and keep those repeat customers.

Customers that have keys made in the shop receive a business card with our special "key club" stamp on the back. A simple and inexpensive rubber stamp is used to print the "key club" information on the back of the business card. There are nine empty boxes on the key card. Each time a customer buys a key, a "key" stamp is used to "validate" the key card. When the card is full, the customer is entitled to a free key. His card is then placed in a jar, prominently displayed in the shop, for a drawing. Every so often, we draw a card and award a prize to a lucky customer.

We do the same for regular business customers, those that have keys made by impression or reading. After their cards get nine "special" stamps, the tenth is free. Most car dealers are happy to participate.

Glenn Schock  
Kentucky

\*\*\*\*\*

This Technitip concerns the Sentry Survivor series fire safe, model SV-1. A customer brought in this safe after losing the keys and asked me to open it. Since I never throw away any old spec sheets, I found a parts list for the safe among my files and found that the key was standard for all models. I called the company, to order a key, and was told that the model had been discontinued and that no parts were available.

After studying the lock, I determined that a Schlage wafer style key, Star SH2 (Ilico 1302A, Curtis SC6) key could be used to operate the lock if the shoulders

**medeco**<sup>®</sup>  
HIGH SECURITY LOCKS

***The market leader  
in locking systems  
for security, safety,  
and control.***

[Click here for more information](#)



**Key for a Sentry Survivor  
SV-1**

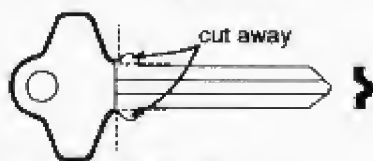

Illustration 3

were cut back as you see in illustration three. This modification allows the key to enter the lock far enough to operate the latch. No cuts are required in the key, to operate the latch mechanism.

Larry Kanzer  
Pennsylvania

\*\*\*\*\*

The following is an answer to **Technitip Challenge** calling for a method for removing both soft and hardened drive pins from blind holes.

List of recommended tools: 1) Dremel die grinder, drill motor or shop drill press, 2) Counterbores (interchangeable pilot, less pilot): 3/26" dia. for 1/16" pins, 3/8" dia. for 1/8" pins. 3) 1/2" abrasive cut-off disk for grinder. 1/32" thick. 4) Flush cutting diagonal pliers. (See illustration 4.)

**Diagonal cutting pliers  
end view**



standard flush cutting  
Illustration 4

Using the proper counterbore, place over the pin so that the pin will enter the center hole of the counterbore. The pin will act as a pilot, to keep the counterbore milling cutter from walking. A drill press and solid clamping of the part, is essential for the pilotless counterbore to work effectively. Cut away the material surrounding the pin, to leave the flush pin exposed.

Use the abrasive cut-off wheel and die grinder to "notch" the pin as close to the surface of the part as possible. Notch the pin on two sides, to make a place for the flush cutting diagonal pliers to grip. The notches do not have to be very deep, only about .010" into the pin.

Grip the pin with the flush cutting diagonal pliers, and rock the pliers back, to lift the pin from the part. Slip a shim under the plier, to gain more travel, as you pry the pin free.

I have been using this method, or portions of it for years. Removing drive pins can be a real challenge to your ingenuity sometimes. Every one is a little different.

Bob Murely  
Tennessee

\*\*\*\*\*

We have all run into installation jobs on doors that do not have an outlet nearby for our drills. The most common are those 2nd floor apartments with a door at the bottom of a flight of stairs.

For those jobs, I carry a little adaptor that threads into a light socket. Most entry doors will have some type of light fixture close by. Unscrew the lamp, and screw in the adaptor to provide yourself with power close to the door. Emergency exit lights are always handy when you're working in a large apartment complex or factory environment. The adaptor is a very handy addition to your installation kit.

Ted Swirsky  
New Jersey

\*\*\*\*\*

**NATIONAL**

**AUTO LOCK SERVICE, INC.**

***National Auto Lock Service, Inc. offers a wide range of equipment and services for the Automotive Locksmith. From tools and hard to find key blanks to transponder programming, we can take the mystery out of car service. We accept credit card orders, and can ship COD. Contact us for the latest in automotive technology.***

[www.laserkey.com](http://www.laserkey.com)

# Newsmakers

## New Products and Industry News

### Corby's 1992 Calendar Is Twice As Good!

For the fourth consecutive year Corby Industries, Inc. is offering security dealers and installers a new, 1992 limited edition, 17" x 11" glamour calendar. The Allentown based Access Control manufacturer is currently providing over 50,000 copies to their alarm distributors worldwide.

Both sides of the calendar were utilized to provide collectors a choice between two distinct vertical poses of Midi Miller, Corby's 1992 glamour calendar model.

The 16 month glossy calendar is available at all Corby's authorized distributor branch locations.



Circle 305 on Rapid Reply

### Valli & Colombo Designer Door Levers

This full color broadside folder highlights the premiere line of Italian door lever sets, cabinet hardware, knobs, hooks and door accessories offered by Valli & Colombo, a name respected in the finest homes worldwide for over half a century.

Over one hundred products are shown in this new folder representing the company's Valli & Colombo, Forges and Fusital lines. All three lines include a broad selection of door handles and coordinated accessories. Designs include traditional, contemporary and trend-setting styling in brass, chrome, 24K gold and colored finishes.

Functions include: passage, privacy, dummy and entry functions.

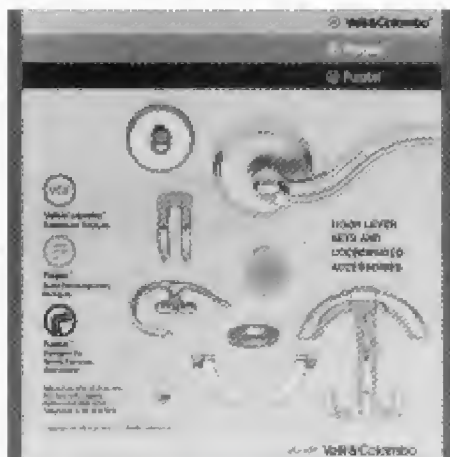

Circle 306 on Rapid Reply

### Security 777 USA, Inc. Offers High Security

Dr. Alois Crepinsek is the president of the company and the inventor of a revolutionary new product. The ER-1 deadbolt is the only one in the international market featuring a 3" stainless steel bolt.

For narrow stile aluminum doors the CO-7 is the only lock in the market which needs no protection plates to prevent removal of the cylinder. The cylinder is flush with the door frame and is protected by the heavy duty lock body. The bolt can resist 25,000 pounds of force versus only 1,000 pounds for some other manufacturers. Dr. Crepinsek holds U.S. and foreign patents on these locks as well as padlocks, automotive cylinders, desk locks and more.

The products are priced very competitively so you can offer a high security product to the customer at attractive prices. Dr. Crepinsek notes that he is grateful to the over 3000 locksmiths who have requested information on the products. Because new management has now been formed, the company will be able to respond to all inquiries.

Locksmiths may become factory authorized and will qualify for free training, and high profit opportunities.

Circle 307 on Rapid Reply

Continued on page 18



**Make Sargent & Greenleaf's  
Comptronic locks your  
choice for electronic safe  
locking solutions.**

[Click here for more information](#)



Continued from page 16

## New Tailgate Lock For Pickup Truck Owners

Pickup truck owners look around the back before driving off these days because tailgate theft has suddenly become big business. Steadfast Auto Security first heard of the problem through their distributor in Texas. His dealers were asking for a good looking, effective tailgate security device that didn't require drilling holes. So, Steadfast developed POP & LOCK, a tailgate lock that needs no tools or holes for installation.

Currently POP & LOCK fits full size Chevrolet and G.M.C. pickup trucks (1988 and up) with Ford models scheduled for late fall.



Circle 308 on Rapid Reply

## American Lock Co.'s Interchangeable Cores

American Lock Company is pleased to announce an addition to its safety lock out system: interchangeable core padlocks (Model #3105, #3106, and #3107). These padlocks provide the ability for American Lock Company's color coded padlocks to accept Best Lock™, Arrow, Falcon®, Eagle and Lockwood cylinders.

Available in six colors (red, blue, green, gold, duranodic, and black), these 1-1/2" wide aluminum body padlocks provide the versatility to adapt to all your Safety Lock Out needs. These padlocks are also available in three shackle lengths.

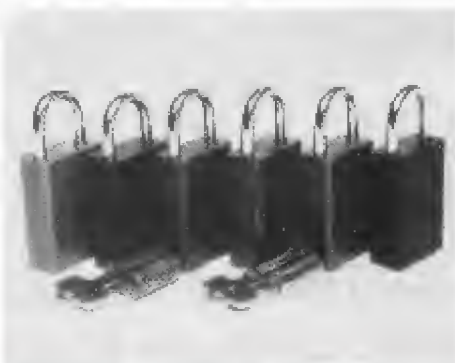

Circle 309 on Rapid Reply

## Photonic's High Tech Hialeah Alarm

The LiteChain from Photonic Alarm Products of Hialeah offers the latest in fiber optic technology. The LiteChain is a fiber optic cable which cannot be broken without sounding an alarm. The thin, flexible loop makes it easy to protect a wide variety of valuable, large or small. It is safe and easy to install.

Each fiber is light activated by a special low-power electro-optic module with built-in alarm lights and buzzer. The cable is looped through valuables and any time the light path is broken, an alarm sounds. The system is tamper-proof and weather-proof. Another important benefit is that LiteChain will not create any electric current or sparks.



Circle 310 on Rapid Reply



# STRATTEC™

***The world's largest producer of  
automotive locks and keys.***

[Click here for more information](#)

## Turn 10 Wholesale Offers Free Freight/Free Banner

Turn 10 Wholesale now offers a free Safe Banner with your next 500 lbs. of Gardall safes. It's a top quality banner (\$40.00 value) that helps you sell more safes. Participating locksmiths love the banner but really love the "Free Freight" on all safe orders.

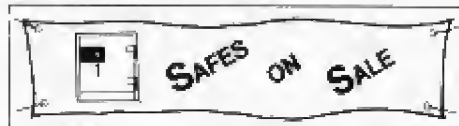

Circle 311 on Rapid Reply

## Detex Presents Thriftlock™ Relatching Exit Locks

Detex Corporation announces the introduction of new Thriftlock™ relatching exit control locks to protect doors from unauthorized entry while allowing emergency exit from the inside. Unauthorized use sounds a high-decibel, directional alarm which is audible even in high noise level industrial and commercial environments.

Compactly designed with exclusive microprocessor-based circuitry, the new Thriftlock™ or ECL-8000 series brings economy as well as solid state reliability and instantaneous response to exit control.

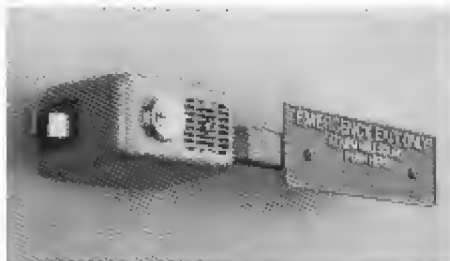

Four models in the new exit control lock series include both battery and AC powered models in cross bar and push pad configurations. All feature compact, aesthetically pleasing die cast cases which are designed for durability and ease of installation.

Circle 312 on Rapid Reply

## Master Adds 'Susanna™' Leverset

Master Lock has expanded its stunning Designer Series collection of door hardware with the new Susanna leverset. The Master Lock Designer Series is the first door hardware marketed under the Master Lock name.

Sturdy, yet stylish, the Susanna lever embellishes and accentuates the unique



elements in any room. A polished face stands in contrast to the black nickel detailing. The Susanna comes with bright brass, antique brass and bright

chrome finishes.

Levers are only part of the Designer Series line; choose from knobsets, deadbolts and entrance handles. The Designer Series is a collection of solid brass door hardware that adds sophistication, grace and elegance to homes. Forged from seamless solid brass, the collection pieces are hand-buffed to a brilliant luster. The collection covers a broad range of traditional American and classical European style to enrich the look and feel of any home.

Circle 313 on Rapid Reply

**SRI**  
**SECURITY**  
**RESOURCES INC.**

**SRI and Steve Young are  
working together to bring  
you the best in locksmith  
tools and supplies.**

[Click here for more information](#)



# 1992 Locksmith Directory

This Directory contains the names and addresses, and phone numbers for the hundreds of manufacturers and distributors serving the locksmith industry. Each company has been given the opportunity to write a short paragraph about themselves. This gives you a chance to learn more about the various companies in the industry.

Save this issue for reference throughout the year of 1992. If you ever have a question, problem, order or a comment to make, you can use this

Locksmith Directory to help you get results. Remember, these companies exist to help you, the locksmith. But they cannot become more responsive to you if you do not keep in contact.

We have tried very hard to make this Locksmith Directory complete with all the information you might need during the upcoming year. However, it is possible that some information might have inadvertently been omitted. If this is the case, then a future issue will contain an addendum to this list.

## Manufacturers

### A-1 SECURITY MFG. CORP.

3528 Maryland Ct.  
Richmond, VA 23233  
(804) 747-0095  
FAX: (804) 747-0534

Key Personnel: Frank McCarthy, GM; Ricky King, Prod. Mgr.  
In business for 230 years, A-1 is a manufacturer of unique locksmith tools. With over 60 items offered, A-1 is best known for its line of I/C tools (The Block, Capping Press, Dumping Block); tubular cutters and picks; car opening tools and numerous other hand tools. Products are handled through qualified distributors.

See ad on page 63

### AAA PRODUCTS INT'L.

2012 Shea Rd.  
Dallas, TX 75235  
(214) 357-3851  
FAX: (214) 357-7222

Key Personnel: August Schulz, Exec. VP; Harry Womack, VP-R&D; Irby Bennett, Sales Supv.  
AAA Products International-Jiffy ML-7 Locksmith Vice; Jiffy QS-12, C.E-12, FG-12 high speed attachments, factory recommended for the HPC-1200 CM. Jiffy MA-1 centerline, no slip impressioning tool, Jiffy GM-1 Cap Clincher, Jiffy MT-1 Tubular Impressioning Tool.

See ad on page 111

### A.D.D.M. International Inc.

3091 Trinity St.  
P.O. Box 572  
Oceanside, NY 11572  
(516) 766-5997  
FAX: (516) 678-0259

Key Personnel: A. Cesser, Pres.  
A.D.D.M. International Inc. markets

gas alarms for various gases. The two most popular models are: GHD 2000 for propane, butane and natural gas and GHD 2001 for carbon monoxide. Those units are manufactured for residential use and come with six foot plug in cord for a simple installation.

### A-J Mfg. Co. Inc.

3601 E. 18 St.  
Kansas City, MO 64127  
(816) 231-5522  
FAX (816) 231-8437

Key Personnel: Robert Haake  
A-J Mfg. Co. specializes in the manufacture of standard and custom made-to-order door louvers, glass lite frames and kick-armor plates.

### Able Locksmiths

91-10 Liberty Ave.  
Ozone Park, NY 11417  
(718) 847-1377

Key Personnel: Frank Markisello, RL, Owner; Elizabeth Markisello,  
We design and sell several tool kits for working on auto locks: The "Side-Kick," Ford "Disc-Out," Ford side bar block. Also Ace Breaker for tubular lock, inter-lockit universal cylinder guard. We are locksmiths trying to make all our jobs a little easier.

### A&B Safe Corp.

2300 Bloomingdale  
Chicago, IL 60647  
(312) 342-0068  
FAX: (312) 342-6694

Key Personnel: F. Bernath, Pres.; N.A. Bernath, Sec'y./Treas.; Keith Adkins, GM/Plt. Supt.

### ABC Lock Co.

P.O. Box 6033

Omaha, NE 68106  
(402) 346-8338

Key Personnel: Don Parkins, Owner; Jan Parkins, Pres.

Keybox: metal key storage boxes for service trucks and shops. Rod Biter, Button Biter and Door Jack tools, Dog Tooth, Vampire, Zoro, car and truck opening tools with teeth.

### Abloy Security, Inc.

6200 Denton Drive  
Dallas, TX 75235  
(214) 358-4762  
FAX: (214) 353-0273

Key Personnel: Charlie Armstrong, GM; Rock Bodenschatz, NE Reg. Mgr.; Jerry Stuart, OEM Sales Mgr.; Mark Imhof, Prod. Mgr.

Abloy Security manufactures and distributes a complete line of maximum security locks and replacement cylinders. Products offer superior physical strength, patented keyways, and extensive master keying capabilities. Several dealer programs are available.

### Abus Lock Co.

218 W. Cummings Park  
P.O. Box 2367  
Woburn, MA 01801  
(617) 935-8370 (800) 225-5348  
FAX: (617) 938-7009

Key Personnel: S.S. Crissman, Pres.; A.J. Steffenberg, VP; Len Stoia, Sales Mgr.

A worldwide manufacturer of padlocks and security locks, makers of the original Diskus, now made in six models. Four original lines of brass padlocks are also made by Abus.

*Continued from page 22*

**Accurate Lock & Hardware Co.**  
Annie Pl.

Stamford, CT 06902  
(203) 348-8865

FAX: (203) 348-5234

Key Personnel: Ronald M. Salvatore,  
Pres.

Manufacturers of Accurate. Accurate  
custom manufactures locks,  
architectural hardware for restoration  
projects and to designers  
specifications.

**Adams Rite Manufacturing Co.**

4040 So. Capitol Ave.  
City of Industry, CA 91749

(213) 699-0511

FAX: (213) 699-5094

Key Personnel: J. Mark Kelly, GM.;  
David Orban, Sales Mgr.

Architectural hardware: locks, latches,  
handles, exit devices, electric strikes,  
etc.

**Adapt-A-Bore**

318 North Milwaukee St.  
Milwaukee, WI 53202

(414) 291-5684

FAX: (414) 291-5685

Key Personnel: James P. Holzer, Nat'l.  
Sales; Andrew S. Pokrass, Mng.  
Partner

Adapt-A-Bore's lock installation device  
is designed to allow the use of  
conventional lock installation tools for  
a variety of manufacturers' specific  
lock boring requirements without the  
use of paper templates. Adapt-A-Bore  
is available as a kit for your existing  
Kwikset installation set. The Kwikset

installation kit is also available with  
the Adapt-A-Bore unit.

**Adcor Electronics**

4130 Shirley Drive, S.W.

Atlanta, GA 30336

(800) 229-ADCOR, (404) 691-8920

FAX: (404) 691-5569

Key Personnel: Robert C.  
Montgomery, Pres.; Gordon Venkins,  
VP Finance; Sylvia Mallison, Nat'l.  
Sales Mgr.;

Manufacturer of proprietary digital  
receivers and printers; receiving and  
reporting system for openings and  
closings; telephone line monitors;  
cellular back-up systems for alarm  
transmission; digital communicators;  
voice tape dialers; power supplies.

**ADESCO SAFE MFG. CO.**

16720 S. Garfield Ave.

Paramount, CA 90723

(800) 821-6803 CA (800) 554-8118 GA

FAX: (714) 761-2846 CA

FAX: (404) 493-8809 GA

Key Personnel: Gene S. Halls,  
Owner/Pres.; David Halls, Sales/Mfg.-  
CA; Steve Mitchell, Sales -GA

Adesco is a manufacturer of quality  
high burglary safes. The line includes  
floor safes, depository safes, and free  
standing safes, "B" rated through UL  
TL30. Custom units designed and built  
upon request. Adesco imports a full  
line of insulated fire safes. Large stock  
of inventory available.

**See ad on page 30**

**ADRIAN STEEL CO.**

**906 James St.**

Adrian, MI 49221

(800) 677-2726

FAX: (517) 265-5834

Key Personnel: Karen Poe, Sales  
Coordinator

Service van interior equipment (i.e.,  
drawer units, cabinets, shelving, bins),  
safety partitions and ladder racks for  
full size and mini vans.

**See ad on page 66**

**Advance Car Mover Co.**

112 N. Outagamie St.

P.O. Box 1181

Appleton, WI 54912-1181

(414) 734-1878

Porter spring winder makes extension  
and compression springs up to 1-1/4"  
I.D. from wire up to 3/16" diameter.  
Hook on spring looping tool forms  
perfect loops and hooks on springs to  
1/2" OD. Other accessories include  
cut-off nipper for hard wire and  
packaged music wire to 3/16"  
diameter.

**Aero Lock**

P.O. Box 16434

Memphis, TN 38186-0434

(800) 627-9433

Key Personnel: Jim Clark, Owner;  
David Parrott, Owner, Monika Parrott,  
Owner

Aero Lock produces key sets designed  
to aid the locksmith in opening and  
fitting keys quickly and easily to many  
types of locks. "Tryout" sets, cut key

*Continued on page 26*



**SCHWAB CORP.**

*Fire protection for your vital records.*

**Free freight!!**  
**No middle man!!**

[Click here for more information](#)



**Aero Lock**

*Continued from page 24*

sets, and depth key sets are available for domestic and foreign cars, motorcycles, boats, luggage, and office furniture. Free catalog by request.

**Aiphone Intercom System**

1700 130th Ave., N.E.  
Bellevue, WA 98005  
(206) 455-0510

Key Personnel: Jim Morrison, Nat'l Sales Mgr.

Aiphone offers intercom systems for home, business and industry. From simple two-station to complex commercial and industrial systems, Aiphone intercoms emphasize design simplicity, technical excellence, and reliable performance.

**Ajax Wire Specialty Co. Inc.**

119 Bloomingdale Rd.  
Hicksville, NY 11801  
(800) 966-AJAX

Key Personnel: Joseph Elowsky, Pres.

**Alarm Electronics Mfg. Co.**

Rt. 2, Box 99-1  
Taylorsville, NC 28681  
(704) 632-3365

Key Personnel: Ed Bosner  
Manufacturer of miniature wireless transmitters styled as wristwatch, pendent, or key ring used for holdup, medical, auto alarm, door strikes and many other applications.

**Alarm Products International**

375 Rabro Dr.  
Hauppauge, NY 11788  
(516) 582-1581

FAX: (516) 582-6711

Key Personnel: Manny Lopez, Pres.;  
Specializing in apartment or condominium alarms, all self-contained. Ideally suited to the locksmith trade. We also manufacture tape and digital dialers and micro-processor controls.

**Alarm Lock Systems, Inc.**

333 Bayview Ave.  
Amityville, NY 11701  
(516) 789-4871

FAX: (516) 789-3383

Key Personnel: Richard Paladino, VP; Bruce E. Stewart, Sales Mgr.  
Pioneering the integration of fire safety hardware with the advantages of access control, Alarm Lock Systems, Inc. continues to move forward offering advanced solutions to the safety/security dilemma. Their new line of delayed egress panic hardware provides maximum security while allowing unobstructed exit in emergency situations.

**Alarm-Saf**

12 Henshaw St.  
Woburn, MA 01801  
(617) 935-5354

FAX: (617) 938-6437

Key Personnel: Gordon Pendleton, Mktg. Mgr.; Joel Labbe, Sales Mgr.  
Alarm-Saf manufactures a complete line of power supply and battery chargers UL listed for fire, burglar, and access control. Commercial versions available up to 16 amps capable of charging 200 AH battery systems.

Other product include 7 day multi-event programmable timers, sensitive trip relay modules, and high powered siren drivers.

**All-Lock Co., Inc.**

900 S. Ravenwood Dr.  
Selma, AL 36701  
(205) 874-9001

FAX: (205) 874-9011

Key Personnel: Ronald B. Hermann, Pres.; James J. Gibbard, VP/GM; Russell Alsbrook, Nat'l Sales Mgr.  
All original equipment manufacturer of domestic and foreign automotive locks, key blanks, service kits, cam locks and automotive service tools.

**All-Lock Co., Inc.**

P.O. Box 3042, U.S. Rts. 1 and 130  
No. Brunswick, NJ 08902  
(201) 545-7000

Key Personnel: Ronald B. Hermann, Pres.; Stan Fine, VP Sales/Mktg.; Rusty Alsbrook, Nat'l Sales Mgr.  
Domestic and foreign automotive locks and service kits, key blanks, cam locks and service kits, and training seminars.

**Allied-Gary International**

P.O. Box 947 Gary Way  
Waynesboro, GA 30830  
(404) 544-1918 (800) 456-4279

FAX: (404) 554-3319

Key Personnel: Robin Hunt, Pres.; Bill Rimmer, GM  
Manufacturers of quality "made to order," money chests, UL safes, bank equipment, mercantile vault doors and

*Continued on page 28*



***ASP Covers the World of Auto Locks***

[Click here for more information](#)

*Allied Gary International*

*Continued from page 26*

autobank cash handling systems.

**Allied Products**

1816 Settlers Oval  
Cleveland, OH 44145  
(216) 871-8909

Key Personnel: Tim Mc Nicholas,  
Pres.; Tim Howard, VP-Mktg.  
Manufacturer of security system  
components, relays, switches.

**Almet Hardware Ltd.**

8205 Montreal-Toronto Blvd.  
Montreal, Quebec H4X 1N1  
(800) 363-2114, (514) 364-4211  
FAX: (514) 364-4912

Key Personnel: David Klein, Pres.;  
Aubrey Sievert, Sales Mgr.  
Manufacturers of decorative lock  
hardware for both commercial and  
residential markets. Almet is now  
featuring new designs in solid brass  
and colored levers in their new Encore  
line.

**ALMONT LOCK CO., INC.**

113 School St.  
Almont, MI 48003  
(313) 798-8950

Key Personnel: Arcardia Popovici,  
Pres.; David Popovici, VP; W.L. Pluck,  
Mktg. Mgr.  
Manufacturer of padlocks and cylinder  
locks.

**See ad on page 16**

**The Allen Corporation**

105 Jefferson Centre, Ste. 220  
South Bend, IN 46601  
(219) 232-9030

Key Personnel: Larry M. Blad, Pres.;  
Fred Severns, VP  
Allen Corporation's CargoLock™,  
LockMaster™, and OverGuard™ are  
lock protection devices (LPD)  
engineered to be used on swing-out,  
roll-up, and storage area doors to  
provide solid defense against bolt  
cutters, hacksaws, prybars, hammering  
or tampering. These three easy-to-use  
LPDs are designed for use with  
standard 2" padlocks.

**American Device Mfg. Co.**

1003 W. Broadway  
P.O. Box 8  
Steeleville, IL 62288  
(618) 965-3491

FAX: (618) 965-9022

Key Personnel: Tom Walls, VP-Mktg.  
American Device has been in the  
manufacturing business over 65 years,  
producing quality products for the  
construction industry. These products  
currently include a complete line of  
panic and fire exit devices and postal  
specialties.

**American Eagle Lock Company Inc.**

P.O. Box 232  
Akron, PA 17501  
(800) 645-7455

FAX (914) 698-7932

Key Personnel: Jack Murphy, Pres.  
Full line of removable core systems  
and products. Full line of cylindrical  
locks and mortise locks.

**AMERICAN LOCK CO.**

3400 W. Exchange Rd.  
Crete, IL 60417  
(708) 534-2000

FAX: (708) 534-0531

Key Personnel: George Junkunc, Pres.;  
Jim Miller, Sales Mgr.; Bob Wilkosz, VP  
Sales/Mktg.

Manufacturer of solid steel and solid  
brass padlocks, hasps, cam locks, inner  
cylinder locks, replacement rim and  
mortise cylinders, and combination  
padlocks.

**See ads on pages 31, 84, 85, 102, 103**

**AMERICAN SECURITY PROD. CO.**

11925 Pacific Ave.  
Fontana, CA 92335  
(800) 421-6142, (714) 685-9680

FAX: (714) 685-9685

Key Personnel: Frank Cademartori,  
Pres.; Robert Sallee, Nat'l. Sales Mgr.  
Manufacturers of Amsec, Star and  
Major brand safes. Offering burglary  
resistant safes, fire resistant safes and  
custom safes. Manufacturing quality  
safes for over 40 years.

**See ad on page 51**

**Amerock Corp.**

4000 Auburn St.  
Rockford, IL 61125  
(815) 963-9631

FAX: (815) 962-0153

Key Personnel: Rich Dell, Pres.; Tom  
Martenson, VP Sales

Manufacturer and marketer of quality  
cabinet, bath and door hardware.

**Amsco • Valley Forge**

101 Corporate Drive  
Hauppauge, NY 11788  
(516) 435-1400

NY: (800) 832-8898

USA: (800) 645-5604

Key Personnel: Mel Minoff, Pres.; Sal  
Saccullo, VP

Automotive Manufacturing and  
Supply Co. purchased Valley Forge  
Products Co. Inc. from Avnet on April  
1, 1988. Amsco • Valley Forge will be  
updating and increasing their coverage  
of foreign and domestic automotive  
ignition, door and trunk locks in the  
near future.

**Architectural Control Systems, Inc.**

10666 Gateway Blvd.  
St. Louis, MO 63132



**DEI**

**We have it all.  
Quality, Value,  
& Service**

[Click here for more information](#)



(314) 432-5588, (800) 753-5558

FAX: (314) 432-2090

Key Personnel: Dave Senften, Pres.;  
S.A. Caponi, VP; Mark LeGrand, Sales  
Mgr.

Manufacturers of the patented Gemini  
Locking System and the Gemini High  
Security Keypad. Electric hinges,  
electric mortise and cylindrical locks  
are our specialty. Included in the ACSI  
product line are electric bolts, electric  
strikes, power suppliers and a full line  
of door controls.

**Argus Security International**

94-28 Northern Blvd.

Jackson Heights, NY 11372

(800) 88-ARGUS, (718) 458-6707

FAX: (718) 899-1623

Key Personnel: Dennis Shields, Pres.;  
Bill Festa, VP

Specializing in auto security for over  
10 years. Designing and manufacturing  
security systems that save time of  
installations, are full featured and are  
so flexible that you can meet any  
customers needs with it. convenience  
features, high security and low costs  
are Argus' outstanding features.

**Aritech Corp.**

1510 Tate Blvd., SE

Hickory, NC 28601

(800) 800-2626

FAX: (704) 324-8028

Key Personnel: Jim Synk, CEO; David  
Miller, VP-CM; David Ledgerwood,  
VP-Sales

Aritech Corp. manufactures Moose  
brand controls, power supplies,  
audibles and accessories, as well as  
Aritech brand motion sensors and  
related products. Noted for their  
dependability and ease of installation,  
these products are available from all  
major distributors of security products  
worldwide.

**Armadillo Safes**

P.O. Box 1719

San Marcos, CA 92079-1719

(619) 744-4992 (800) 835-6011

FAX: (619) 471-0974 (805) 239-5713

Key Personnel: Mike Walsh, Sales, No.  
Office; Sunny Gilbert, Sales Factory;  
Jerry Outlaw, Plant Mgr.

We're "The Safe Burglars Hate" floor  
safe and chest safes. Both standard and  
custom. We use only high quality  
materials, no secondary steel.

**ARMITE LABORATORIES**

1845 Randolph

Los Angeles, CA 90001

(213) 587-7744

FAX: (213) 587-5075

Key Personnel: J.H. Armington, Pres.;  
Howard Hansen, VP-Sales; Mary  
Wilcox, Controller

Manufacturer of moisture remover,  
antiseize, rust buster, synthetic instru-  
ment oiler. Manufacturing since 1928.

See ad on page 68

**ARMOR SAFE CORP.**

1435 Grand Ave.

P.O. Box 1719

San Marcos, CA 92079-1719

(619) 744-4992 (factory)

(800) 835-6011 (No. Office)

FAX: (619) 471-0974 (factory)

FAX: (805) 239-5712 (No. office)

Key Personnel: Mike Walsh, Sales, No.  
Office; Sunny Gilbert, Sales Factory;  
Jerry Outlaw, Plant Mgr.

All materials are completely new  
interchangeable boltwork. Complete  
line of UL labeled TL-15, TL-30 burglar  
resistive money safes for supermarkets  
and drug chains. Special designs for  
clients' individual requirements.

See ad on page 82

**Armored Manufacturing Co.**

3004 N. 23rd Street

La Porte, TX 77571

(713) 471-3156, (713) 471-3157

Key Personnel: Don Appelgren, Pres.;  
Steve Foster, VP-Sales/Mktg.

Armored Manufacturing Company  
manufactures patented padlock  
protectors. We also build special  
padlock protectors on order.

**Armstrong Security Lock Corp.**

54-45 44th St.

Maspeth, NY 11378

(800) 622-LOCK, (718) 392-9000

Key Personnel: Mark Berger, Nat'l.  
Sales Mgr.

A Division of Securitech Group, Inc.,  
Armstrong created the 2-inch deadbolt,  
top rated by Consumer Reports.  
DoubleThrow projects a full two inches  
while leaving 5/8" of solid steel inside  
the door. New 1-1/2" throw model also  
available for special applications  
(narrow jambs, sidelights, etc.).

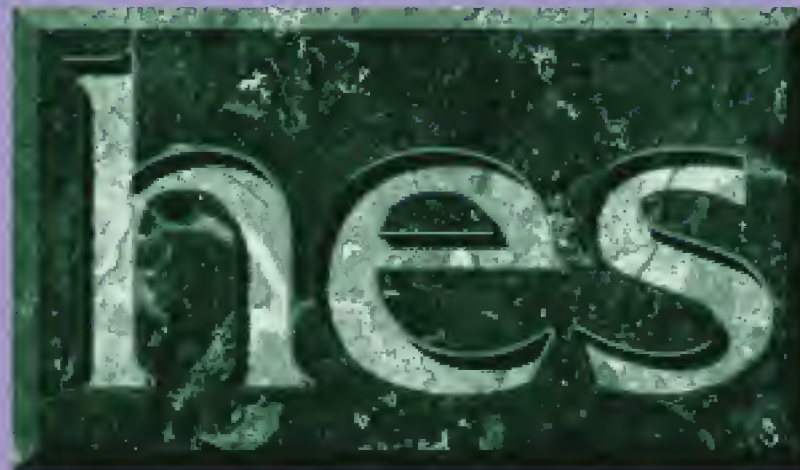

**To be a World Leader  
You Need Quality  
Products, Innovative  
Technology and  
Strong Partners.**

[Click here for more information](#)

**ARROW MFG. CO.**  
103-00 Foster Ave.  
Brooklyn, NY 11236  
(718) 257-4700  
FAX: (718) 649-9097

Key Personnel: E. Pugatch, Pres.; P.R. Garofano, VP-Mktg.; T.G. Louglin, Mktg. Mgr.

We distribute through locksmith wholesalers a full line of cylindrical, mortise and deadlocks. A full line of exit devices and alarms plus door closers. For the best alternative to interchangeable cores, Arrow has the full line.

See ad on page 17

**ASSA High Security Locks**  
1235 Naperville Drive  
Romeoville, IL 60441  
(708) 759-3222  
FAX: (708) 759-1060

Key Personnel: Wayne Wilkerson, Pres.; Mike Crowder, Sales Mgr.; Tom Kijowski, Controller

ASSA High Security Locks manufactures a full range of high security retrofit cylinders, deadbolts and padlocks. Patented, geographically protected keyways are available to distributors, locksmiths and end-users. Also offering the HALT line of narrow-stile locks.

**ATEK Locksmith Products**  
2510 N. Ashland  
Chicago, IL 60614  
(312) 348-5106

Key Personnel: Jim Gruber, Mtg.; Joe Gruber, Pres.; Paul Killion, Sales

Manufacturer of locksmith tools specializing in tubular lock picking and custom made tools. Founders of Atek have been manufacturing locksmith products since 1959.

**Audio Alert Systems**  
4208 Dover Rd.

Louisville, KY 40216  
(502) 448-6699

Key Personnel: Glenn Isaacs

**AUTH CHIMES**  
561 Acorn St.

Deer Park, NY 11729  
(516) 242-2493

FAX: (516) 242-7742

Key Personnel: Jonathan Ingham, Pres.; Donna Miller, VP, Gen. Mgr.; Dorothy Wagner, Prod. Supv.

Auth Chimes, one of the country's oldest door chime manufacturers, has been the choice of architects, contractors and builders for 100 years. The company stands behind its products with a free replacement policy for parts worn through normal use. We now feature U.L. fire rated viewers.

See ad on page 3

**AUTH/FLORENCE CO.**  
2139 N. Elston Ave.  
Chicago, IL 60614

(312) 384-3310

FAX: (312) 384-3460

Key Personnel: Michael Gioseff, Pres.; Mike Gioseff Sr., VP; Frank Vecchione, Nat'l. Sales Mgr.

Suppliers of high quality USPS and

private distribution postal specialties products and accessories.

See ad on page 39

**AutoPage, Inc.**

1815 West 205th St., Ste. 101  
Torrance, CA 90501-1525

(213) 618-2002

FAX: (213) 533-0258

Key Personnel: Mike Northup

**Auto-Security Products**

P.O. Box 2937

Kirkland, WA 98083-2937

Key Personnel: Buddy Logan, Pres.;

Dick Brandon, Mktg. Mgr.

Replacement locks, lock parts, keying kits, etc. For over 30 makes of Asian and European vehicles.

**BALDWIN HARDWARE CORP.**

841 E. Wyomissing Blvd.

Reading, PA 19612

(215) 777-7811

FAX: (215) 777-7256

Key Personnel: Anthony Sturris, Pres.; Wayne Baker, VP-Sales; Joel Fastow, Sales Mgr. (East).

Baldwin manufactures forged brass residential and commercial locks, trims and other architectural hardware and offers a full range of lock functions and trim designs. Locks are available with various backsets. Products are specially designed for use on high-end custom residential and commercial projects.

See ad on page 101

Continued on page 32



**HPC, Inc.**

**Designing Excellence and Manufacturing  
Quality since 1956**

[Click here for more information](#)



Continued from page 30

**Baton Lock Co.**  
11521 Salinaz Drive  
Garden Grove, CA 92643  
(800) 395-8880

FAX: (714) 530-9813

Key Personnel: Peace Hsu, Pres.;  
Sharron C. Hsu, VP; Kris Newman,  
Sales Mgr.

On September 1, 1982, Baton Lock Co.  
was founded and on September 1,  
1989, it was incorporated. Products:  
stainless steel padlocks, brass padlocks,  
laminated steel padlocks, space locks, 6  
pin rekeyable padlocks components  
with the most popular keyways, A1-  
Security cam locks, tubular key cam  
locks, switch locks, economy cam locks  
and accessories, ID key rings/tags.

**Bax Technologies**

1816 Johns Drive  
Glenview, IL 60025  
(708) 729-8339

FAX: (708) 729-7886

Key Personnel: Frank P. Baxpehler,  
Pres.

Bax Technologies is a division of F.P.  
Baxpehler & Associates, Ltd. supplying  
a unique line of 'Integrated Cable  
Locks' to manufacturers and  
importers/master distributors.

**Bell Detection Mirrors**

Division of Bell Glass and Mirror Co.  
894 Coney Island Ave.

Brooklyn, NY 11218  
(718) 633-4000

FAX: (718) 854-8909

Key Personnel: Art Brenner, GM  
Manufacturers of U.S. and foreign-  
patented Bell Detection Mirrors, Bell  
Security Mirrors, Bell Surveillance  
Mirrors, Bell Safety Mirrors, Bell Traffic  
Mirrors, Bell Inspection Mirrors, Bell  
Mira-Domes, and Bell Convex Mirrors,  
for safety, security and accident  
prevention.

**Belwith International, Ltd.**

995 Godfrey S.W.  
P.O. Box 0335  
Grand Rapids, MI 49501-0335  
(616) 247-4250 (800) 648-4321  
FAX: (616) 247-4090

Key Personnel: Richard Krud, Pres.;  
Mark Polley, VP Sales /Mktg., Donald  
K. Pegel, Dir. of Mktg.

Belwith offers a complete line of  
auxiliary security devices. Full line of  
padlocks, window locks, keyed  
window locks, keyed door lock, night  
latches, deadbolts, keyed specialty  
locks. Locksmith in store display  
merchandisers also available.

**Best Lock Corp.**

P.O. Box 50444  
6165 E. 75th St.  
Indianapolis, IN 46250  
(317) 849-7829

**Best Power Technology, Inc.**

P.O. Box 280  
Necedah, WI 54646  
(608) 565-7200, (800) 356-5794  
FAX: (608) 565-2221

Key Personnel: Steve Paul, VP-Eng.;  
Wayne Toenjes, Mktg. Dir.; Ken Urban,  
Mfr. of Mktg. Com.

On-line, advanced technology,  
uninterruptible power systems from  
360VA to 18 KVA protect micros, minis,  
workstations, LANs,  
telecommunications equipment and  
anything else that needs continuous,  
computer-grade power. All models are  
made in the USA, and all 60 hertz  
models are UL listed. CSA certification  
is available as an option.

**Blackhawk Products**

201 North Harvey  
Oak Park, IL 60302  
(708) 383-9632

Key Personnel: Roger Weitzenkamp  
Software products for IBM include  
COD: Codes on Disk; KBX: Key Blank  
Cross-References; FILL Fill the  
Combination; CBI: Code Book Index,  
and RDA: Reverse Domestic Auto. We  
also have reverse code books for  
General Motors (including Saturn) and  
Chrysler.

**Arthur Blank & Co., Inc.**

225 Rivermoor St.  
Boston, MA 02132  
(617) 325-9600  
FAX: (617) 327-1235

Eric Blank, VP Mktg.; Jerry Sumner,  
Sales, Mgr.

Arthur Blank & Co. is a major  
manufacturer of printed plastic  
products for the security and lock  
industries. The product line includes  
high security access entry cards, credit  
cards, I.D. cards and systems plus  
parking tags and visitor badges.

**Bommer Industries, Inc.**

P.O. Box 187  
19810 Asheville Hwy.  
Landrum, SC 29356  
(803) 457-3301  
FAX: (803) 457-2487

Bommer Industries has been  
established for over 116 years,  
manufacturing "specialty hardware"  
including spring hinges and lavatory  
hardware for the contract, commercial  
and residential markets. For the past 45  
years, Bommer has been a major  
manufacturer of postal specialties,  
including USPS approved mailboxes,  
collection boxes and parcel lockers.

**BORROUGHS TOOLS**

2429 N. Burdick  
Kalamazoo, MI 49007  
(616) 345-2700  
FAX: (616) 345-9121

Key Personnel: Joyce Pierce,  
Purchasing  
Service tools for GM automotive lock  
systems.

See ad on page 63

**Bridgeman**

1511 E. Edinger Ave.  
Santa Ana, CA 92705  
(714) 543-2691  
FAX: (714) 543-7450

UL vault doors and modular panels;  
TL 15 and TL 30 safes; safe deposit  
boxes and lockers; pneumatic point to  
point systems; X4 safe deposit box  
locks, etc.

**BRIGGS & STRATTON TECH.**

P.O. Box 702  
Milwaukee, WI 53209  
(414) 259-5333

Key Personnel: Harry Stratton, VP-  
Corporate Mgr.; Curt Larson, VP-  
Sales/Mktg.; Scot Hooper, Mgr.-Svc.  
and Aftermarket Sales

Briggs and Stratton has been a  
supplier of quality automotive locks  
since 1907. Briggs has been the choice  
of General Motors, Chrysler, Ford and  
all major over the road truck  
manufacturers. These OEM quality  
locks are available to the locksmith  
through 73 authorized wholesale  
distributors.

See ad on page 45

**R.R. Brink Locking Systems Inc.**

500 Earl Road  
Shorewood, IL 60436  
(815) 744-7000  
FAX: (815) 744-7020

Key Personnel: Robert R. Brink, Pres.;  
Diane M. Ganster, VP-Operations;  
Charles R. Brink,  
Sales/Mktg./Estimates Mgr.

R.R. Brink Locking Systems  
manufactures electromechanical locks  
and control systems with emphasis on  
detention hardware. Included in the  
product line are: Heavy-duty swinging  
door electric locks; sliding door locking  
and operating devices; access panel  
latches and deadbolts; door position  
switches; security door pulls, and high-  
security six pin cylinders.

**Brookfield Industries**

99 West Hillside Ave.,  
P.O. Box 548  
Thomaston, CT 06787  
(203) 283-6211  
FAX: (203) 283-6123

Key Personnel: Karl Kinzer

**Brown Safe Mfg.**

439 W. San Marcos Blvd.  
San Marcos, CA 92069  
(800) 641-7233, (619) 744-4888  
FAX: (619) 744-4055

Key Personnel: Frederick L. Brown,  
Pres.

Manufacturers of burglary safes and  
vaults, including floor safes, burglary  
chests, gun and wall safes for the home  
and office. Jewelers safes offered in TL-  
15, TL-30, and TRTL-30x6 ratings and a  
complete line of B, C, and TL-15, TL-30  
rated depositories. Custom safes for  
individual and contract quantities are  
also available.

**Buddy Security Systems**

1350 S. Leavitt  
Chicago, IL 60608  
(800) 443-5133

Key Personnel: Sam DiFiglio Sr., Pres.;  
Rich Matula, Sales Mgr.

Buddy Security Systems manufactures  
all their products in the USA. They  
have a complete line of high quality  
cash boxes, key cabinets and an ever-  
expanding line of safes.

**C&A CONTROL SYSTEMS INC.**

7117 Commercial Park Drive  
Knoxville, TN 37918



LOCKMASTERS  
SECURITY  
MANAGEMENT

TM



LOCKMASTERS  
SECURITY  
MANAGEMENT

TM

**Providing quality  
tools, parts,  
and service for  
the security  
professional.**



LOCKMASTERS  
SECURITY  
MANAGEMENT

TM



LOCKMASTERS  
SECURITY  
MANAGEMENT

TM

[Click here for more information](#)

*C & A Control Systems Inc.*

*Continued from page 32*

(615) 922-2148

FAX: (615) 922-2148

Key Personnel: Alex Cantrell, Pres.;  
Rick Cantrell, Mgr.

C&A Control Systems, Inc. has been recognized as the pioneer and leader in remote auto starting since 1983. We are committed to continue setting the pace. Our SmartGuard™ and LA-Z Start™ products are made in the USA. Call us for a brochure and information package.

**See ad on page 12**

**Calibro Corporation**

511 East 127th St.

Lemont, IL 60439-4402

(708) 257-8008

FAX: (708) 257-7235

Key Personnel: Darius A. Povilaitis,  
GM

Car stereo anti-theft locks. Lasso lock has cable that lassos around steering wheel, and lock that slips into cassette slot. Deter stereo and vehicle theft. Once locked in place, it forcibly removed, car stereo would be rendered inoperable. Highly visible, foolproof, and simple to use. High profit, self-selling accessory item, retails at \$29.

**California Security Cans**

530 Cypress Ave.

Hermosa Beach, CA 90254

(800) 848-0067

FAX: (213) 372-2160

Key Personnel: Margaret Meenahan

We specialize in the manufacture of can safes made from the actual product container.

**CANNON SAFE INC.**

9358 Stephens St.

Pico Rivera, CA 90660

(213) 692-0636,

(800) 222-1055 (CA),

(800) 242-1055 (Nat'l.)

FAX: (213) 692-7252

Key Personnel: Steve Baker, Pres.;

Richard J. Rundell, GM

Manufacturer of various size steel commercial safes, plus gun and home security safes.

**See ad on page 43**

**Cansec Systems Ltd.**

2 Robert Speck Pkwy., Suite 570

Mississauga, Ontario, Canada L4T 1H8

(416) 897-1762

FAX: (416) 897-5588

Key Personnel: Fred Dawber, Pres.; Jim Brion, VP Op; Joseph Caranci, Mgr. Dealer Svc.

**Capricorn Electronics Inc.**

48 Capricorn Dr.

P.O. Box 66

Maiden, NC 28650

(704) 428-3451, (NC),

(800) 438-3750 (Nat'l)

Key Personnel: Keith Long, Pres.; Bill Gronning, VP-Eng.; Robbie Roberson, VP-Op.

Complete burglary and emergency wireless/hardwire systems. Identification of up to 48 individual keypad, smoke, handheld, window/door, miniaturized pendant,



**Capricorn Electronics Inc.**

*Continued from page 34*

glassbreak, transmitters, etc. Hardwire zones identified also.

**Cardkey Systems Inc.**

101 West Cochran St.  
Simi Valley, CA 93065  
(805) 522-5555  
FAX: (805) 526-0064

Key Personnel: Joseph A. Vona, Pres.  
Cardkey is the oldest access control company and the largest supplier of access control systems in the world. Cardkey addresses a broad spectrum of facility management needs. In addition to access control, we offer alarm monitoring, T/A, CCTV, vehicle management, elevator and parking control and more.

**CCL SECURITY PRODUCTS**

199 Whiting St.  
New Britain, CT 06051-4360  
(203) 229-6199  
FAX: (203) 223-7601

Key Personnel: James T. Salonia, Dir.-Sales/Mktg.; Joseph Pihiel, Nat'l. Sales Mgr.

CCL Security Products is a quality manufacturer of padlocks and cabinet hardware. Product line includes the Sesamec "keyless" padlock line, keyed padlocks, cabinet, drawer, enclosure, sliding door, cam, and special purpose locks along with handles and drawer pull catches. A member of the Eastern Company.

See ad on page 55

**Centurion Deposit Corp.**  
237 Highland Pkwy.

Roselle, NJ 07203  
(908) 241-9277  
FAX: (908) 241-5259

Key Personnel: E.L. Bianco, Pres.  
Money safes and depository chests. Built to order. Contract quantities, small lots, individual pieces. One of the few remaining safe manufacturers that actually produce our own products in the U.S.A.

**Chicago Lock Co.**

4311 W. Belmont Ave.  
Chicago, IL 60641  
(312) 282-7177

Key Personnel: Dale N. Padjen, Sales Mgr.

Over 70 years experience in the design and manufacture of locking cylinders. The original designers of the Ace tubular lock. Products available through local distributors are original replacement keyblanks, single bit, double bit, Ace and pin tumbler locks.

**Circle-Ess, Inc.**

214 East 2 St.  
Hastings, NE 68901-5217  
(402) 462-2737 (1-9 p.m.CT)

Key Personnel: B.G. Sager, Pres.; H. Roger Grace, Sec'y./Treas.

Circle-Ess key machines. Principally the MB8202. Operates on 12 volts AC or DC and 120 volts AC 50-60 cycle, or can be re-wired to operate on 208 to 250 volts, 50-60 cycles AC.

**CKA Group**

3000 Wilshire Blvd., Suite 1732  
Los Angeles, CA 90010

(213) 386-7995  
FAX: (213) 386-8198

Key Personnel: Ralph Wolf, Sales Manager  
Manufacturing residential door locks. Serves U.S., Canada and Mexico

**Clifford Electronics**

20750 Lassen St.  
Chatsworth, CA 91311  
(818) 709-7551

Key Personnel: Keith Field

**Cobralinks/J.J. Tourek Div.**

1800 Touhy Ave.  
Elk Grove Village, IL 60007  
(708) 640-1700

FAX: (708) 640-0158  
Key Personnel: Peter J. Hoag, Div. Mgr.; Patricia Wolff, Prod. Mgr.

**Cole Consumer Products**

31100 Solon Rd.  
Solon, OH 44139  
(216) 248-7000  
(800) 321-1630

FAX: (216) 248-8051  
Key Personnel: S. Cole

**Cole Key Corp.**

9055 Freeway Drive  
Macedonia, OH 44056  
(216) 473-2000, (800) 332-6530  
FAX: (216) 467-7599

Key Personnel: William E. Shepard, Pres.

*Continued on page 38*

**Major**  
MANUFACTURING, INC.

**Every Installation  
Is a Self-Portrait  
Of the Person Who Did It.  
Autograph Your Work with Excellence.**

[Click here for more information](#)

Continued from page 36

**Colorado Car • Safe Company**  
1944 S. Kearney Way  
Denver, CO 80224  
(303) 692-8044

Key Personnel: William Carmichael, Pres.; Tina Carmichael, Nat'l. Sales  
Car•Safe is a low profile safe designed to bolt under the seat of a vehicle or in the trunk. Reinforced removable lid, for ease of use in tight spots. Two sizes, three models: 9.5" x 11.5" - 2.87" and 12" x 12" x 3.5", two metal thicknesses - 11 gauge and 14 gauge.

**COMMERCIAL VAN INTERIORS**  
8840 St. Charles Rock Rd.

St. Louis, MO 63114  
HQ: (800) 759-7477 (St. Louis, MO)  
(213) 695-7477 (Los Angeles, CA)  
(619) 278-7477 (San Diego, CA)

Key Personnel: HQ: Mark Stegen; Steven Kloessner; LA: Paul Daiber; S.D.: Steve Kloessner  
Commercial Van Interiors distributes nationally complete lines of service vehicle equipment including shelving, bins, drawer units and safety partitions. Manufactures workbench tops, key machine mounting bases and miscellaneous locksmith specialty equipment. Prearranged packages available. Large inventories for immediate shipment. Installation available through branch locations. MasterCard and Visa accepted.

See ad on page 10

**CONTINENTAL INSTS. CORP.**  
70 Hopper St.  
Westbury, NY 11590

(516) 334-0900  
FAX: (516) 334-0235

Key Personnel: Michael Morgenstern, Pres.; John Banks, VP; Robert Weinstein, Mfg. Mgr.  
Access control systems that control from one to hundreds of doors and thousands of card holders and also monitors alarm inputs. A choice of Proximity, Wiegand, Magnetic stripe or Infrared reader technology. All systems are available with English language printout. Also Cypher™ Lock, electronic combination lock.

See ad on page 74

**Continental Micro, Inc.**  
P.O. Box 394  
Park Ridge, IL 60068  
(708) 692-3630

Key Personnel: Thomas Swiderak, Pres.; Lori Lane, V.P.  
Manufacturer of code cards of all types for HPC 1200 CM Code-A-Key Code Machine. High grade cutters for 1200 CM Code Machine.

**Corbin Architectural Hardware**  
**A Black & Decker Co.**  
225 Episcopal Rd.  
Berlin, CT 06037  
(203) 225-7411

FAX: (203) 828-7266  
Key Personnel: John R. Gamble, Pres.; Charles H. Murray, Nat'l. Sales Mgr.; Marilyn A. Burke, VP-Mktg.  
Corbin Hardware has been providing quality hardware since 1849. Complete line includes locksets, closers, exit devices, key systems, and related

locksmith supplies and parts.

**Corby Industries, Inc.**  
1501 E. Pennsylvania St.  
Allentown, PA 18103  
(800) 652-6729, (215) 433-1413  
FAX: (215) 435-1963

Key Personnel: Jeffrey Anthony, Sharon Cain, Richard O'Donnell  
Corby Industries, Inc. provides access control systems, accessories, supplies and digital electronic keypads for every application. Corby systems are available for any size installation: From a single door with several hundred users to computer-based systems with hundreds of doors, multiple building locations and thousands of doors, multiple building locations and thousands of users.

**CorKey Control Systems, Inc.**  
20705 S. Western Ave. #108  
Torrance, CA 90501  
(213) 533-1425

Key Personnel: Lin Depore, Mark Hetzel  
CorKey Control Systems can provide a magnetic key system that operates on mechanical magnetic door locks. This product and its quick change capabilities has been used in hotels, office and industrial buildings, parking systems, etc. The encoding of the re-keying equipment will allow you to have complete control of the system.

**Cosmo Electronics, Inc.**  
250 N. Robertson Blvd. Ste. 600  
Beverly Hills, CA 90211

**medeco**®  
HIGH SECURITY LOCKS

**Integrity. Ingenuity....  
security solutions.**

[Click here for more information](#)



(213) 858-0433

FAX: (213) 858-8873

FAX: (800) 553-5773 (outside CA)

Key Personnel: K. Takahashi, VP; R. Laforteza, Mgr. Sales/Mktg.; S. Lee, Sales Assoc.

Cosmo Electronics Inc., is a manufacturer of digital safes widely known among hotels with over 150 hotel clients worldwide. Carries distinctive patented electronic safes that offer the highest Japanese standard of quality at an affordable price. Models are designed for burglar, pick and fire-resistance.

#### **Costello Security Products**

1045 NW Bond St.

Bend, OR 97701

(800) 441-6773

FAX: (503) 389-8392

Key Personnel: Stephen Costellos,

Pres.; Peter Speech, VP Mktg.

Manufacturer of handgun/shotgun security storage lockers with electronic, instant access and unique pat. pend. quick holstering and retrieval. Features personal easy-to-program code, interior lighting and self contained power source.

#### **Crimestopper Security Products, Inc.**

1770 So. Tapo St.

Simi Valley, CA 93063

(805) 526-9400, (800) 66-ALARM

FAX: (805) 581-9500

Key Personnel: Howard Miller, Pres.; Sharon Miller, VP; Larry Peterson, GM  
Complete line of automotive security products and accessories including

remote control devices, paging alarms, digital and keyless entry systems, key type systems to meet every requirement and vehicle.

#### **Curtis Industries, Inc.**

34999 Curtis Blvd.

Eastlake, OH 44094

(216) 951-2400

FAX: (216) 951-2400 Ext: 398

Key Personnel: F. Kuhar, Pres.; D.

Tengel, VP-Sales/Mktg.; T. Morse,

Security Products Mgr.

Curtis is a leading manufacturer of key blanks; key duplicating machines, (including the #2, the Keymatic 2000, and the Keymatic 3000); the Number 15 Code Cutter. Curtis also distributes many additional locksmith items via its own sales force covering the U.S., Canada and U.K.

#### **CUSTOMLINE, INC.**

950 W. Cienega Ave.

San Dimas, CA 91773

(714) 592-6200

FAX: (714) 599-5776

Key Personnel: Michael Whiting, Sales; Dee Gilbert, Sec.

Customline Gate Operators have been manufactured since 1905. We provide a complete line of gate equipment from three foot, pedestrian gate releases to operating equipment for 200 foot, long commercial gates. Custom equipment is available to meet your specific requirements. Assistance in design, specification writing and engineering is available.

See ad on page 39

#### **Cutter Mfg. Corp.**

P.O. Drawer M

Eaton Park, FL 33840

(800) 237-2312

FAX: (813) 646-4517

Key Personnel: Lori Ladouceur, Nat'l Sales Mgr.; Kathie Guthrie, Sales Super.  
Cutter manufacturing corporation has supplied the building industry with quality postal specialty items since 1883. During the past twenty-five years, Cutter has diversified its product line to include trash and linen chutes, tenant storage lockers, pneumatic air tub systems and newspaper vending racks.

#### **CWECO**

P.O. Box 2456

Gardena, CA 90247

(800) 292-9326

FAX: (800) 232-9326

Key Personnel: David Gursky, Pres.;

Chuck Magnuson, VP

CWECO manufactures stainless steel grab bars and has a complete line a Zamak bathroom accessories, soap dispensers, hotel, motel and commercial washroom accessories.

#### **Dalme, Inc.**

7234 Eton Ave.

Canoga Park, CA 91303

(818) 712-0422

Key Personnel: Vincent Gagliano

# NATIONAL AUTO LOCK SERVICE, INC.

**National Auto Lock Service, Inc. offers a wide range of equipment and services for the Automotive Locksmith. From tools and hard to find key blanks to transponder programming, we can take the mystery out of car service. We accept credit card orders, and can ship COD. Contact us for the latest in automotive technology.**

[www.laserkey.com](http://www.laserkey.com)

**Dayton Safe Company**

605 Springfield St.  
Dayton, OH 45403  
(513) 253-6668

Key Personnel: Sara Nagler, Pres.;  
Elliot Nagler, Sec'y.

Dayton Safe Company has a standard line of money chest models, these units can be modified to satisfy your requirements. We also custom design and build, from drive-up depositories to under counter "bleed boxes." Our solid steel safes are available in "B," "C," and "E" rate, with deposit slots, time locks, etc.

**Deck Slider of Florida**

771 110th Ave. N.  
Naples, FL 33963  
(813) 566-3415 (800) 782-1474

Key Personnel: Robert Gaynor, Pres.  
Manufactures and sells Deck Slider II, a state-of-the-art cargo access and storage system for pickups, vans and suburbans. Deck Slider II mounts to the vehicle bed and slides out like a drawer, providing quick and easy access to cargo.

**Decorators Accessories, Ltd.**

12970 Branford St., Unit J  
Pacoima, CA 91331  
(818) 504-0888  
FAX: (818) 504-9456

Importers of decorative door and cabinet hardware and bathroom accessories. Also do refinishing and plating of any hardware item. Complete stripping, polishing and plating facility.

**Deronde Products, Inc.**

200 Cornwall Ave.  
P.O. Box 243  
Buffalo, NY 14215-0243  
(716) 895-8888, (800) 346-8926  
FAX: (716) 895-9987

Key Personnel: Alexander Catalano, Pres.; Calvert Maurer, Exec. VP;  
Charles N. Long, Jr., Contract Admin.  
Deronde Products, manufacturers of custom steel, stainless steel and textured stainless steel doors and frames for the commercial market as well as the institutional market. Deronde stocks galvanized sheet steel and stainless steel in gauges ranging from 18 to 12 gauge.

**Detec Security Systems, Inc.**

927 Calle Negocio, Suite A  
San Clemente, CA 92672  
(714) 366-9391  
FAX: (714) 366-9436

Key Personnel: Mike A. Sansky, Pres.  
Designers and manufacturers of innovative security equipment for home, business, motorhome, boat and door announcers. Our entire product line is designed for the do-it-yourself project.

**Detex Corp.**

302 Detex Dr.  
New Braunfels, TX 78130  
(512) 629-2900, (800) 729-3839  
FAX: (512) 620-6711

Key Personnel: Philip Haselton, Pres.;  
Anthony Mudford, VP; Robert, Mac Donald, Dir. Mktg./Sales  
Designs, manufactures and distributes exit locks, alarms, remote panels,

access control devices and associated commercial industrial door security products. Off-the-shelf units capable of stand-alone or interface into complete systems capable of meeting the specific need.

**DETROIT MINI-SAFE CO.**

9950 Freeland Ave.  
Detroit, MI 48227  
(313) 931-7720

FAX: (313) 931-7758  
Key Personnel: Sheldon Wiener,  
Owner

All steel deposit safes for trucks, stores, theaters, gas stations.

See ad on page 121

**Dom Security Locks**

A Black & Decker Co.  
225 Episcopal Rd.  
Berlin, CT 06037  
(203) 828-7263

FAX: (203) 828-0808  
Key Personnel: Grace Bulluss  
Dom Security Locks is a major manufacturer of high security cylinders, locksets, commercial and industrial grade disc tumbler locks, key systems and related locksmith supplies.

**Don-Jo Manufacturing**

36 Pratt's Junction Rd.  
Sterlin, MA 01564  
(508) 422-3377, (800) 628-8389  
FAX: (508) 422-3467

Continued on page 42



**Choose S&G Comptronic  
electronic safe locks for...security...  
technology...tradition.**

[Click here for more information](#)



**Don Jo Manufacturing**

*Continued from page 40*

**Key Personnel:** Tim Roy, VP  
Don-Jo Manufacturing manufactures wrap-around plates, remodels plates, push & pull plates, kick-plates, latch protectors, strike plates and filler plates, combining all accessories for door and frame into one complete product line, packaged and cataloged with locksmiths in mind.

**DOOR CONTROLS INT'L.**

**2362 E. Bishop  
Dexter, MI 48130  
(313) 426-0400  
(800) 742-3634 (WATTS)  
FAX: (313) 426-0405**

**Key Personnel:** Ralph D. Maynard Jr., Pres.; John C. Maynard, VP; Joseph A. Ghergo, VP-Sales  
Door Controls International manufactures life safety hardware. The line features UL listed door coordinators, automatic and constant self latching flush bolts and accessories. The Pannex is a security fire-rated rim exit device. Capabilities include alarming, audible or silent, remote monitoring and a lock/unlock module. Also available are wall, dome and floor stops, holders, kick downs and roller latches.

**See ad on page 136**

**Door King, Inc.**  
120 Glasgow Ave.  
Inglewood, CA 90301  
(800) 826-7493 (213) 645-0023  
FAX: (213) 645-7431

**Key Personnel:** Scott Holmes, Mktg. Dir.; Tom Richmond, VP; Dusty Beeding, Sales Dir.  
Door King is a manufacturer of access control products including telephone entry systems, digital locks, card readers, gate operators, and the popular "no phone line" phone. Door King has been a leading manufacturer since 1948.

**DOOR SYSTEMS, INC.**

**333 Byberry Rd.  
P.O. Box 576  
Hatboro, PA 19040-0576  
(215) 672-8087  
FAX: (215) 672-8298**

**Key Personnel:** David C. Deardorff, Pres.; Tanya Kunevich, VP; Alan Scotkin, VP  
DSI is the exclusive supplier of the Digital Door Lock®, a keyless, push-button, mechanical access control for all types of residential and commercial doors and cabinets. DSI offers seven models and 10 finishes for both new and replacement installations.

**See ad on page 139**

**Dor-O-Matic  
Div. of Republic Ind. Inc.**  
7350 W. Wilson Ave.  
Harwood Heights, IL 60656  
(708) 867-7400

**FAX: (708) 867-0310  
Key Personnel:** F.J. Chubbuck, Nat'l Sales Mgr.  
Manufacturers of aluminum door hardware as well as handicap operators to comply with current laws as established by the "Handicap Bill of

Rights, American Disabilities Act."

**Dorma Door Controls Inc.**

Dorma Drive  
Reamstown, PA 17567  
(800) 523-8483  
FAX: (800) 274-9724  
**Key Personnel:** Stephen Hildebrand, Mktg. Mgr.  
Dorma Door Controls manufactures a complete line of surface applied, concealed, and fire/life safety door controls.

**Dortronics Systems, Inc.**

Sag Harbor Turnpike  
Sag Harbor, NY 11963  
(516) 725-0505  
FAX: (516) 725-4234  
National Sales Office:  
16 East Maxwell Dr.  
West Hartford, CT 06107  
(203) 561-0665  
FAX: (203) 561-5977  
**Key Personnel:** Irving Saphirstein, Exc. VP Sales/Mktg. & Devel.; Mary Scheerer, Cust. Svc. Mgr.  
Designers and manufacturers of electro-magnetic locking and door control equipment and special application components and systems, including direct hold surface and mortised magnetic locking devices, power supplies and systems controllers and general and special purpose controls and monitoring assemblies.

**DYNALOCK CORPORATION**

**280 Redstone Hill Rd.  
Forestville, CT 06010  
(203) 582-4761  
FAX: (203) 585-0338**  
**Key Personnel:** Ralph Sittnick, Pres.; Gary Gibson, VP; Mark Gibson, Treas.  
DynaLock Corporation is a manufacturer of advanced design electromagnetic and electric deadbolt locks for high security and access control installations, plus supportive equipment such as power supplies, station controls, keyswitches, control consoles and mounting accessories.

**See ad on page 113**

**ECCO Industries, Inc.**

130 Centre St.  
Danvers, MA 01923  
(508) 777-7750  
FAX: (508) 777-7753  
**Key Personnel:** Michael A. Backler

**Eclipse Industries**

1250 Industrial Ave.  
Escondido, CA 92029  
(619) 746-1016  
FAX: (619) 739-0072  
**Key Personnel:** Martin Stinson, Pres.; Robert Peddicord, Mgr.  
Manufacturer of above and below ground burglary safes for home, commercial, and gun use.

**EG & G Astrophysics Research Corp.**

4031 Via Oro Ave. (90810)  
P.O. Box 22709  
Long Beach, CA 90801-5709  
(310) 513-1411  
FAX (310) 512-6593  
**Key Personnel:** Ray Yates, Pres.; Dan

Vontobel, VP Sales & Mktg.; Dave deMoulied, Dir. Mktg.  
EG&G Astrophysics Research Corporation is the worldwide leader in the design, manufacture and placement of X-ray security screening equipment and walk-through metal detectors. Over 70% of the world's busiest airports, nuclear power plants, correctional institutions, governmental and commercial buildings and courthouses have chosen our equipment.

**Electronic Locking Specialists, Inc.**

2043 Wellwood Ave.  
East Farmingdale, NY 11735-1283  
(516) 753-6100 (800) 825-LOCK  
FAX: (516) 753-6004  
**Key Personnel:** John Fitzpatrick  
Manufacturers of various electronic locking devices and accessories for the access control and electronic locking industry. Also distributes for most major electronic lock manufacturers.

**ESL (Electro Signal Lab, Inc.)**

75 Terry Drive  
Hingham, MA 02043  
(617) 740-3800 (MA),  
(800) 225-8632  
FAX: (617) 740-4391  
**Key Personnel:** William P. Adams, VP-Sales; Marc Koczwarra, Dir.-Mktg.; Kevin Araujo, Product Mgr.  
ESL is a leading manufacturer of photoelectronic and ionization system smoke detectors, heat detectors, fire alarm control panels, air duct smoke detectors, and a range of other fire protection accessories.

**Esmet, Inc.**

1406 5th St. SW  
Canton, OH 44702  
(800) 321-0870  
FAX: (216) 452-2557  
**Key Personnel:** Dorothy Pullin, Sales; Lynn Poje, Sales; Joseph Trombetta, Mktg. Mgr.  
Esmet, Inc. is a manufacturer specializing in the design and production of high security mechanical locks, storage containers and weapon rack systems under the brand, Tufloc™. Tufloc products have applications in many commercial, industrial, law enforcement and military buildings and vehicles.

**ESP CORP.**

**(Engineered Security Products)**

**375 Harvard St.  
Leominster, MA 01453  
(508) 537-6121  
FAX: (508) 537-1699**

**Key Personnel:** Vince Spadafora, VP-Sales & Mktg.; Patrick Baker, Nat'l Sales Mgr.  
Manufacturer of key blanks, key duplicating machines, locksmith tools and equipment, cam locks, desk and pin tumbler, mailbox and file cabinet locks, consumer accessories including Hide-A-Key, Key Koil, Ident-A-Key, Design-A-Coil, Spiderclip and Key Klip. Other trade names: Hide-A-Key Plus.

**See ad on page 27**



Continued from page 42

**ESSEX**  
1130 Mark Ave.  
Carpinteria, CA 93013-2987  
(805) 684-7601, (800) 628-9673  
FAX: (805) 684-0232

Key Personnel: K.F. Zimmerman, Pres.; Kathleen Morgan, Mktg. Coord. Essex Technologies Corporation is a manufacturer of Keyless Entry® Coded Access systems for residential, commercial, elevator and automotive applications. All systems include weather and vandal resistant touchpads. The residential and commercial Keyless Entry® Systems provide years of reliability and are simple to install.

See ad on page 158

**Henry A. Evers Corp.**  
72 Oxford St.  
Providence, RI 02905  
(401) 781-4767

FAX: (401) 781-9581

Key Personnel: Rosemarie Naismith, Sales Mgr.; Anthony DiOrto, Pres. Manufactured steel marking devices such as hub forcers, die (embossing) key stamps, tang stamps. You create it, we make it.

**Facilitrac®**

64 E. Broadway Ste. 230  
Tempe, AZ 85282  
(602) 967-8617, (800) 843-8722

Key Personnel: Mike Marinello, Mktg. Dir.

Grandmaster @ PC-based computerized key control software. Tracks thousands of locks, keys, personnel and all other related information. Prints 14 informative reports for locksmiths as well as the office administrator. Easy to operate, simple to set-up, with multi-level password security and on-line help.

**Falcon Lock**

7345 Orangewood Ave.  
Garden Grove, CA 92641  
(714) 373-2880, (800) 226-41569  
FAX: (714) 373-1377  
(800) 777-8229

Key Personnel: E.F. Johnson, Pres.; Ed Poole, VP Sales & Mktg.; Don Johnson, Regional Sales Mgr.; Patti Kreff, Cust. Svc. Supv.

Falcon is a full line commercial lockset manufacturer able to supply standard keyways and interchangeable core systems within eight weeks of order in all architectural finishes.

**Ferma-Lok Inc.**

243-22 Merrick Blvd.  
Rosedale, NY 11422  
(718) 525-0568

Key Personnel: Bruno Interrante, Pres.; Elizabeth Rallo, VP.

We are manufacturers and distributors of an effective anti-theft device for the trunk of General Motors cars.

**Fireking International, Inc.**

900 Park Pl.  
New Albany, IN 47150  
(812) 948-8400

Key Personnel: Van G. Carlisle, Pres. Manufacturers of Fire King,

**Folger Adam Co.**

16300 W. 103rd St.  
Lemont, IL 60439  
(708) 739-3900

FAX: (708) 739-6138

Key Personnel: Donald C. Stading, Pres.; Robert J. Carter, VP-Sales; A.A. Nobile, Sales Mgr., Architectural Security Products

Folger Adam Company manufactures a complete line of door security products including electric strikes, electric locks, electric deadbolts, institutional and high-security hinges. Desktop control consoles, and a variety of remote actuation/control devices such as pushbuttons and keyswitches are also offered.

**FORT KNOX SECURITY PROD.**

1051 No. Industrial Park Rd.  
Urem, UT 84057  
(800) 821-5216

Key Personnel: Tom James, Pres.

Fort Knox is the only home security safe company using rack and pinion gear mechanisms to secure their doors. Banks have been using this system for over 100 years.

See ad on page 8

**FORT LOCK CORP.**

3000 River Rd.  
River Grove, IL 60171  
(800) 323-1587, (708) 456-1100

Key Personnel: Lloyd Falk, Pres.; John Hutzenlaub, VP-Mktg./Sales  
Manufacturer of round and flat key switch, cam and specialty locks. A complete series of these locks are manufactured as multi-function locks® exclusively for the locksmith. All come packaged to create many different locks all from one set of parts and are rekeyable. Contact factory to become an authorized dealer.

See ad on page 53

**Framon Mfg. Co. Inc.**

909 Washington Ave.  
Alpena, MI 49707  
(517) 354-5623

FAX: (517) 354-4238

Key Personnel: Frank Agius, Pres.; Mike Agius, VP

Framon Mfg. produces a full line of quality key machines including the Framon #2 code machine, the Sidewinder high security automotive duplicating machine, the DC-300 code and duplicating machine for automotive, the DBM-1 flat steel duplicator, the TKM-100 tubular key machine and other small tools for the locksmith profession.

**Franklin Mfg., Div. of Embassy Ind.**

300 Smith Street  
Farmingdale, NY 11735  
(516) 694-1800

FAX: (516) 694-1836

Key Personnel: Lawrence Franklin, Pres.; Pat Rosen, Administrative Asst. Passage, private and entry locksets. Manufacturer and importer of quality security products since 1925. Line includes: deadlocks, jimmy proof locks, night latches, garage door locks, rim and mortise cylinders, chain door

guards, door viewers, police locks, showcase locks, letter box and drawer locks, patio doors and all types of window locks.

**GARDALL SAFE CORP.**

219 Lamson St.  
Syracuse, NY 13206  
(315) 432-9115, (800) 722-7233  
FAX: (315) 434-9422

Key Personnel: Edward W. Baroody, Pres.; Caroline Barnicott, Customer Service Mgr.; Andrew Ash, Dir. of Training & Mktg.

Safe manufacturer, 350 degree, 1 hour fire resistant safes, models 1310-3018, 2 hour models 3620-4820, steel depository safes, rotary, front and back load all "B" rated. Dual purpose "Z" safes feature "B" rated chest welded inside the fire resistant safe. Additional products, wall, utility, floor and gun safes. Custom safes built to your specification.

See ad on page 7

**General Tool & Die Co., Inc.**

1420 9th St.  
Racine, WI 53403  
(414) 632-0286  
FAX: (414) 632-9763

Key Personnel: Frank Holding, Prod. Mgr.

The Panic Bar Retainer allows you to hold panic bars in the unlocked position, simply depress the bar and place the hook over it. Models available to fit most styles of panic hardware, can be installed on wood, metal and glass doors. Available in anodized aluminum, brass and bronze finishes.

**GIL-RAY TOOLS**

1306 McGraw St.  
P.O. Box 801  
Bay City, MI 48707  
(517) 892-6870

Key Personnel: David J. Deuel, Pres.; Laurie Bedell, Cust. Svc. Mgr. Gil-Ray Tools Inc. has manufactured premium high speed steel key machine cutter wheels since 1945. New cutters are available direct to the locksmith through their free catalog and are also available through selected distributors. Gil-Ray Tools offers a dependable mail-in cutter sharpening service.

See ad on page 122

**Glynn Johnson**

2720 Tobey Dr.  
P.O. Box 6135  
Indianapolis, IN 46206  
(317) 899-9440  
FAX: (317) 899-9432

Key Personnel: Robert M. Brokamp, Sales Mgr.

**GNI**

P.O. Box 1675  
Santa Rosa, CA 95402  
(707) 528-8083  
FAX: (707) 528-8085

Key Personnel: David A. Kesselman, Pres.; Shirlee Turnipseed, Mktg. Coordinator; Jack Thatcher, Production Mgr.

GNI designs, manufactures and

Continued on page 46



GNI

Continued from page 44

markets proprietary high security fasteners, seals, locking devices and specialized security hardware for OEM accounts.

**G.R.I. Telemark Corp.**

802 South Elm  
Kimball, NE 69145  
(800) 445-5218  
FAX: (308) 235-3561

Key Personnel: Mary Ann Brothers, Pres.

G.R.I. manufactures magnetic contact switches for the security industry. Recently introduced the unigard window security bars, which have an alarm device for 24-hour protection. Gives the classic look of French windows. Removes easily for fire safety or cleaning. Windows can be opened or closed with alarm on. Lifetime warranty.

**Guard Security Hardware**

808 Georgia Ave.  
Brooklyn, NY 11207  
(718) 272-1540  
FAX: (718) 272-8335

Key Personnel: Bobby Winterstein, Pres.; Howard Berger, VP  
Manufacturer of Guard, Encoda, Magnum II, Diamond, Lion.

**Hager Hinge Co.**

139 Victor St.  
P.O. Box 12300 Soulard Station  
St. Louis, MO 63104  
(800) 325-9995

FAX: (800) 782-0149  
Key Personnel: A.W. Hager III, Pres.; John Wotawa, VP-Sales; Frank

Bloecher, VP-Architectural Sales  
Hager Hinge has been in the business of manufacturing contract grade hinges, spring hinges, electric hinges and consumer hardware for over 135 years.

**Hampton Products International**

11 Marconi  
Irvine, CA 92718  
(714) 472-4256  
FAX: (714) 472-9657

Kim Kelley, Pres.; Tracy Hampton, VP, Sales; Jeannine Hampton, VP Mktg.  
Hampton Products International features weatherproof, rustproof and waterproof padlocks. Hampton has introduced their "designer locks" for an exciting new look in today's color-conscious marketplace. Other new and innovative products from Hampton include Lok-Box and Mini Lok-Box portable security vaults.

**Hanchett Entry Systems, Inc./h.e.s., Inc.**

216122 N. 7th Ave.  
Phoenix, AZ 85027  
(602) 957-2472, (800) 626-7590  
FAX: (800) 626-7590

Key Personnel: Leland J. Hanchett, Jr. Pres.; Michael A. Webb, VP-Mktg.  
H.E.S. manufactures a complete line of heavy duty UL fire door and burglary resistant listed electric strikes able to accommodate virtually every type of lockset, including the ability to release a 1" deadbolt. H.E.S. also manufactures a new line of adjustable electromagnetic door holders used with fire and smoke barrier doors.

**Handykey**

1800 Abbott St.  
Salinas, CA 93901  
(800) 626-4448  
FAX: (408) 757-3270

Key Personnel: Graham Powell, CM  
Affordable proximity access control for two doors and 99 users. Handykey readers are weatherproof and easy to install. The vandal-resistant reader will withstand abuse. The mullion reader fits on a door frame. Each electronic key has a lifetime warranty, cannot be copied and is easily added/deleted from any Handykey system.

**Harloc Inc.**

P.O. Box 429  
501 Railroad St.  
Taylorsville, KY 40071  
(800) 542-7562  
FAX: (502) 477-8831

Key Personnel: Tom Jennings, Pres.; Gary T. Jouvelakas, VP-Sales  
Harloc Products is now a member of the Newman Tonks group. Harloc offers value-oriented retail hardware programs to sturdy, heavy-duty lock and lever sets designed to withstand even the most punishing of commercial applications.

**Harrison Electronic Systems**

51 Gravel St., Box 1758  
Wilkes-Barre, PA 18705  
(717) 825-0540, (800) 422-5050  
FAX: (717) 823-6343

Key Personnel: Peter Uzups, Nat'l Sales Mgr.; Karen Keefer, Pres.; Bob Justice, Reg. Sales Mgr.  
Harrison Electronics, vehicle security



**STRATTEC™**

**The world's largest producer of  
automotive locks and keys.**

[Click here for more information](#)

manufacturer since 1971, offers a full line of remote control and passive vehicle alarms, starter kills, sensors and installation hardware. Harrison's pager-alarm is used for vehicle, home and business protection. Harrison is a full-service company, providing toll-free technical support, installation training, and consumer displays and brochures.

**Hartwell Commercial Division**

620-A South Jefferson St.  
Placentia, CA 92670

(714) 993-2752

FAX: (714) 993-4783

Key Personnel: Edward Wendeln, Mgr. Cons. Prod.; Marvel Phillips, Sales Coord.

Hartwell manufactures Shack'L Shield reinforced padlock protectors that prevent the use of bolt cutters. Horizontal and vertical models offer combinations of full surface, full mortise and surface/mortise mounting to fit padlocks from 1-1/2" to 2-1/2".

**Hayman Safe Co., Inc.**

1295 N. S.R. 426

Oviedo, FL 32765

(407) 365-5434

FAX: (407) 365-8958

Key Personnel: Gary Hayman, Don Jensen

**Hercules Industries, Inc.**

S. Main St. Box 197

Prospect, OH 43342

(800) 345-2590, (614) 494-2628

FAX: (614) 494-2274

Key Personnel: Paul D. Yates, Pres.; Ray W. Miller, VP; Dave Hook, Dir. Op. Hercules Industries Inc. was established in 1969, basically as a padlock component manufacturer. We now supply a complete line of solid brass tumbler pin padlocks with a wide selection of brass or steel shackles or special made to order.

**HEWI Inc.**

2851 Old Tree Drive

Lancaster, PA 17603

(717) 293-1313

Manufacturer of nylon hardware in 13 colors with contemporary design and consistent styling. Product range includes door hardware, cabinet pulls, bathroom accessories, railings and handicapped support systems.

**Hiawatha Inc., J.L. Industries**

4450 W. 78th St., Circle

Bloomington, MN 55435

(612) 835-4944

FAX: (612) 835-2218

Key Personnel: Robert Dunn, Pres.;

Kirby Bayerle, VP-Sales/Mktg.; Lloyd

Ferrin, Cust. Svc. Rep.

For over 30 years, Hiawatha Inc. has been manufacturing architectural door hardware including pulls, pushes and plates. In the last three years, Hiawatha has added products such as vision lites and louvers, heavy duty tubular custom pulls and nylon color pulls, and our latest addition of shower door pulls.

**HIGH TECH TOOLS**

1400 S.W. 1st St.

Miami, FL 33135

(305) 649-7014, (800) 323-8324

FAX: (305) 541-0074

Key Personnel: Tony Vigil, Pres.

Manufacturer of automotive lock-out tools for all makes and models of cars. Yearly updates of tools for new models.

See ad on page 143

**HILL SPECIALTY PRODUCTS**

E. 711-17 Walton Ave.

Spokane, WA 99207-3099

(800) 722-1142, (509) 487-1142

Key Personnel: Ruth E. Bower,

Owner/Mgr.; Toki E. Miller, Exec.

Asst.; Ilean M. Nelson, Admin. Asst.

Since 1959, we have manufactured the 39-N Okay's Key Safe for men's belts now available in black 39-NXB. For belt-less trousers, the 37-C, 79-G and 79-NB in grey and black is longer for wide (Sam Browne) belts. Also chains in 8" and 18" lengths, 49-NX, 49-NSX and (65-N 18"). (800) 722-1142 is now available to our Canadian customers.

See ad on page 136

**Hirsch Electronics Inc.**

1751 Langley Ave.

Irvine, CA 92714

(714) 250-8888

Key Personnel: Larry Midland, Pres.;

Rich Foster, Exec. VP

**Hollyman Wood Products Ltd.**

1275 Hubrey Rd.

London, Ontario, Canada N6A 4C2

(519) 686-0717

**SRI**  
**SECURITY**  
**RESOURCES INC.**

**SRI and Tech Train Productions are  
the automotive specialists - your best  
source for automotive tools,  
manuals, and videos.**

[Click here for more information](#)



**Hollyman Wood Products Ltd.**

*Continued from page 47*

FAX: (519) 680-1496  
Key Personnel: Max Hollyman, Pres.  
Hollyman frame is a split jamb system pre-mitered, pre-machined for hinge and strike with steel reinforcement plates behind the preps. Available in any wood species or laminate. Fire rated for 20, 45 and 90 minute codes.

**Horizon Safe Manufacturing**  
7034 S. Elmer Ave.  
Whittier, CA 90602  
(310) 698-0789  
Key Personnel: Corey Edwards, Sales Mgr.  
Horizon Safe manufactures quality square door floor safes, including B, C/B, and C rates. Both hinged door and lift-out doors are available. Horizon is also a full line, stocking distributor for Gardall Safe Corporation. Also available are TL15 and TL30 units custom made to order.

**HPC, INC.**  
3999 N. 25th Ave.  
Schiller Park, IL 60176  
(708) 671-6280  
FAX: (708) 671-6343  
Key Personnel: Jerry Hoffman, Pres.; Alan Blitstein, VP-Sales; Francine Hoffman, VP-Mktg.; Laurie Bachleda, Comptroller; Alan Goeke, Dir. of Op.  
The leading designer and manufacturer of key machines, key control cabinets, locksmithing equipment and publishers of code and technical books since 1956.

See ads on pages 2, 13, 94-97

**Hurd Lock & Mfg. Co., Inc.**  
Div. of Avis Industrial  
603 Bohannon Ave.  
Greeneville, TN 37743  
(615) 639-4101  
FAX: (615) 639-0266  
Key Personnel: R. Reid, Pres.; B. Wallace, Purch. Agt.; W. Socha, Dir.-Mktg.

**Hydrosorbent Co.**  
Clayton Rd.  
Ashley Falls, MA 01222  
(800) 448-7903  
FAX: (413) 229-8743  
Key Personnel: Brady Brown, Pres.  
Distributors of Silica Gel Units. Chemical dehumidifier prevents condensation within enclosed areas. Stops rust, mildew, corrosion, spoilage.

**Ileo Unican**  
U.S.: P.O. Box 2627  
Rocky Mount, NC 27802-2627  
(919) 446-3321  
Canada: 7301 Decarie Blvd.  
Montreal, Quebec H4P 2G7  
(514) 735-5411

**Illinois Lock Co.**  
301 Hintz Rd.  
Wheeling, IL 60090  
(708) 537-1800  
FAX: (708) 537-1881  
Key Personnel: R.H. Schulz, Mng. Dir.; Brian Reed, Sales-Mgr.  
Manufacturer of locks directed toward the O.E.M. market place including cam, cabinet and switch locks. Available in a

variety of mechanisms covering a wide spectrum of security levels.

**In-A-Floor Safe Co.**  
1416-18 S. Los Angeles St.  
Los Angeles, CA 90015  
(213) 749-2448  
FAX: (213) 749-2802  
Key Personnel: Carl L. Belknap, Flora W. Belknap.  
Inventors of in-floor type safe. Manufacturers of In-A-Floor Safe. Established 1925.

**Indiana Cash Drawer Co.**  
1315 S. Miller St.  
P.O. Box 236  
Shelbyville, IN 46176  
(317) 398-6643  
Key Personnel: William Showers, Pres.; J.R. Showers III, Sec./Treas.; Bruce L. Mann, GM  
Indiana Cash Drawer Company makes a broad line of wooden or steel cash drawers, for over or undercounter installation, with manual or electronic controls (for use with business or personal computer). Manual model TD-1 has fingerpull locking assembly with alarm that sounds if locking mechanism is improperly manipulated.

**Intelock Corporation**  
7026 Koll Center Pkwy. Ste. 225  
Pleasanton, CA 94566  
(510) 462-2114  
Key Personnel: Tom Corder, Pres.; Debbie Murphy, Controller; Mark McKinzie, Prod. Mktg. Mgr.  
The Intelock Corporation is introducing the new Intelock 1000 and 3000 series of key optional entry locks. Intelock provides the ultimate solution to low cost electronic access while answering the never ending problem of lost, stolen or forgotten keys. Intelock offers advanced technology for security and convenience for you and your customers.

**International Door Closers, Inc.**  
East: 1920 Air Lane Dr.  
Nashville, TN 37210  
(615) 885-7060  
(800) 225-6737  
FAX: (615) 885-0903  
West: 1140 North Kraemer Pl.  
Anaheim, CA 92806  
(714) 666-0390  
(800) 544-4422  
FAX: (714) 666-2215  
Key Personnel: Kenneth T. Yamato, Pres.; Paul R. Linder, Sales/Mktg. Dir.  
International has been supplying the industry with hydraulic door controls and related hardware for nearly a quarter of a century. Surface applied door closers, overhead concealed door closers, and storefront door hardware are available from distribution facilities in Anaheim, California and Nashville, Tennessee.

**International Electronics**  
International Electronics  
427 Turnpike St.  
Canton, MA 02021  
(800) 343-9502  
FAX: (617) 821-4443

Key Personnel: John Mooradian, Sales Mgr.  
International Electronics, Inc. (IEI) manufactures a full line of both access control and command/control keypads offering 12 or 24 volt AC or DC operation, an 8 amp relay, face programming and the ability to interface the output to a computer printer, use these keypads to open or close electric strikes or control equipment.

**Iosso Marine Products**  
1485 Lively Blvd.  
Elk Grove Village, IL 60007  
(708) 437-8400  
FAX: (708) 437-8478  
Key Personnel: Richard Iosso, Pres.; Marianne Snow, VP  
Iosso Polishing Paste will recondition all metals including brass, stainless and aluminum. It removes oxidation, tarnish, surface rust, water spots, calcined deposits, tars and oils. It is excellent for use on brass hardware, locks, door knobs, hinges, kick plates and thresholds. It leaves a shiny brilliant protective coating that guards against future oxidation, fingerprinting and moisture.

**INTRALOCK TOOLS LTD.**  
105-12779 80th Ave.  
Surrey, B.C. Canada V3W 3A6  
(604) 596-8900  
Key Personnel: Gordon Parr, Pres.; Jim Brooks, VP  
We are the manufacturer of the ITL 9000 automated key cutting machine.  
See ad on page 118

**Italbrass Corporation**  
21 Lime St.  
Marblehead, MA 01945  
(617) 639-1992  
FAX: (617) 639-2458  
Key Personnel: Antonio Musso, Pres.  
Fine Italian brass door hardware in unique designs.

**H.B. Ives**  
62 Barnes Park North  
Wallingford, CT 06460  
(203) 294-4837  
FAX: (203) 284-1460  
Key Personnel: Roby Briggs, VP-Sales; Stacey Callahan, Contract Mktg Mgr.; Timothy O'Kane, Nat'l. Sales Mgr.  
Since 1876, H.B. Ives has been manufacturing fine builders and home hardware for the commercial, institutional and residential markets. The line includes flush bolts and coordinators, surface bolts, architectural door trim, door stops and holders, window hardware, hooks and brackets, cabinet hardware, latch sets and mortise bolts, exterior door hardware and bath accessories.

**J&B Key-Rite Mfg.**  
RD #1, Box 217  
Rockwood, PA 15557  
(814) 926-2176  
Key Personnel: Jean Gindlesperger, William Gindlesperger  
Key-Rite Collection: composed of high quality precision tools: JB100 electronic



**SCHWAB CORP.**

*Fire protection for your vital records.*

**It's not  
safe unless it's  
Schwab Safe.**

[Click here for more information](#)

**J & B Key-Kite Mfg.**

*Continued from page 48*

key machine adjuster comes with precision brass plates. Three types of micrometers, KDI-150, KDI-250, JB 350. JB 300 and JB 301 code shaft conversion kits for the Belsaw 200. JB 105 reversible steel cap key machine vise jaws for the Belsaw 200. Other precision tools available.

**JADO Bathroom & Hardware Mfg. Corp.**

4690 Calle Quetzal  
Camarillo, CA 93012  
(805) 482-2666  
(805) 484-4799

Key Personnel: Richard Wickham, Mktg. Mgr.; Carole Olivier, Office Mgr. JADO manufactures solid forged brass door and cabinet hardware including thumbblatch entrance sets, offering a full range of distinctive traditional, classic and modern creations. Each item is the symbol of JADO's commitment to high quality products made in Germany.

**Javelin Electronics**

19831 Magellan Dr.  
Torrance, CA 90502  
(213) 327-7440  
FAX: (213) 327-5405

Key Personnel: Graham Wallis, Pres.; Ray Payne, VP Eng. Manufacturer and distributor of closed circuit television equipment and systems.

**Jensen Tools Inc.**

7815 S. 46th St.  
Phoenix, AZ 85044  
(602) 968-6231

Key Personnel: Gary Treiber, Mktg. Mgr.; Sherman Jensen, Product Dev. Mgr.; Jean Hogg, Sales/Service Mgr. Jensen Tools Inc. is a manufacturer of tool kits for the electro-mechanical and electronics technician. The company sells tool kits, tools, tool cases, shipping containers, and test equipment through national catalog distribution.

**JET HARDWARE MFG. CORP.**

800 Hinsdale St.  
Brooklyn, NY 11207  
(718) 257-9600  
FAX: (718) 257-0973

Key Personnel: Alfred Schonberger, Pres.; Fred Lang, VP; George Buchinger, Sec'y./Treas.

Manufacturer of high precision key blanks, tubular keys, Personaline, engraved key blanks, Squarousel key rack display, keyboard display, key cutting machines, plastic-head keys.

**See ad on page 99**

**KABA HIGH SECURITY LOCKS**

Old Turnpike Rd.  
Southington, CT 06489  
(203) 621-3601  
FAX: (203) 621-9727

Key Personnel: Ed Murphy, Pres.; Dwight Boyer, VP

Kaba High Security Locks manufactures Kaba® Gemini™ UL listed high security cylinders, Peaks™ interchangeable core, mortise, rim and



key-in-knob cylinders with patented key control, Nova electronic access control system, and Brassworks solid brass door hardware.

See ad on page 81

**Kaddies, Inc.**

1601 N. Main St. #203  
Walnut Creek, CA 94596

(510) 934-4488 (800) KADDIES

FAX: (510) 934-4492

Key Personnel: Tom Shetterly, Nat'l. Sales Mgr.

Maker of the Tool Kaddie, a dolly-style tool and parts organizer on wheels.

**Karpen Steel Custom Doors & Frames**

181 Reems Creek Rd.

P.O. Box 67

Weaverville, NV 28787-0067

(704) 645-4821

FAX: (704) 645-3230

Key Personnel: Rachel Smith, Pres.; Joseph Karpen, VP

Karpen Steel Custom Doors and Frames is a quick-ship manufacturer of custom hollow metal doors and frames. All orders are manufactured to the customer's specifications and needs. Karpen guarantees shipment of most orders within 10 working days. Underwriters Laboratories labels are available.

**Ke-Master**

300 S. Pennell Rd.

Media, PA 19063

(215) 459-1129

Key Personnel: Anthony Salamone,

Pres.; Peter Lindley, VP-Sales/Mktg.

Ke-Master manufactures single tag and dual tag key cabinets and key control systems for organizing and securing from 20 to 800 keys. Also available are key tags, file drawer key racks and wall key boards.

**Keedex Manufacturing**

12931 Shackelford Lane

Garden Grove, CA 92644

(714) 636-5657

FAX: (714) 636-5680

Key Personnel: Cornac "Mac" Dorsey, Nat'l Sales Mgr.; Julie McCluney, Partner; George Hill, Partner

Keedex manufactures tools and supplies for the locksmith and safe industries. Locksmith products include reinforcement plates for aluminum frame doors, cylinder guards, weldable gate boxes, 12-volt motors, clip removal tools, followers and the Protect-A-Lok. Safe products include the Safe Buster, change key sets, safe repair kits and safe drill bits.

**Keefe Mfg. Co.**

23 Lexington Ave.

Trenton, NJ 08618

(609) 882-2290

Key Personnel: John Keefe, Rich Keefe  
Manufacturer of wood plugs and templates, security strikes and installation fixtures for installing mortise locks, Adams Rite, flush bolts, key-in-knob, deadbolts, etc.

**Kenstan Lock &**

**Hardware Co.**

166 West Hills Rd.

Huntington Station, NY 11746

(516) 271-2700

FAX: (516) 271-2759

Key Personnel: Frank Lofaro, Dir.-Sales

Kenstan manufactures a full line of showcase and cabinet locks. Its locks can be produced with economical flat key disc tumblers or high security pin tumblers. All locks can be made in six different platings.

**Kent-Moore Automotive Div.**

SPX Corp.

28635 Mound Rd.

Warren, MI 48092

(313) 574-2332, (800) 345-2233

Key Personnel: N. Robert Kindig,

Sales/Mktg. Mgr.; Cheryl A. Wilson,

Prod./Prom. Coordinator

Kent-Moore is an automotive special tool manufacturer for General Motors. We have designed and developed special automotive locksmith tools to make your job quick and easy. All of our tools are lifetime guaranteed and made in the USA.

**KETT TOOL CO.**

5055 Madison Rd.

Cincinnati, OH 45227

(513) 271-0333

FAX: (513) 271-5318

Key Personnel: H. Rowe Hoffman,

Chrm.; William A. Berlier, Pres.; Rick

Fowkes, Sales Mgr.

Trade names-Kett specialty cutting

saws, shears, drilling heads.

See ad on page 126



**ASP - Your Auto  
Service Center  
for the World**

[Click here for more information](#)



**Don't panic!  
We have Security  
Exit Devices.**

[Click here for more information](#)



**KEY BAK DIVISION  
WEST COAST CHAIN MFG. CO.**

1460 So. Balboa Ave.  
Ontario, CA 91761  
(714) 923-7800  
FAX: (714) 923-0024  
Key Personnel: Craig Paugh, Pres.;  
John Iacono, VP; Shirley Paugh, Office  
Mgr.  
Manufacturers of Key-Bak® key chain  
reels, Mini-Bak® key returns and  
quality key accessories. Key-Bak is the  
original key reel and the standard of  
the industry. It is made in the U.S.A.  
and backed by a lifetime service  
policy. The company also produces  
light industrial chain.

See ad on page 127

**Key Products Co.**  
525 W. Plata, Ste. 500  
Tucson, AZ 85705  
(602) 882-5307  
FAX: (602) 882-5375

Key Personnel: Mark Mitchell, Owner  
Key blank inventory control and  
organizational system.

**KEY SURE  
P.O. Box 439, Prince Station  
New York, NY 10012-0008  
(212) 219-0015**

Key Personnel: Len Sideri, CEO  
Keysure, a plastic key control  
container, that protects keys  
individually. Signatures are required to  
make it work. Access to the key is not  
possible without breaking the  
container, indicating its use. Keysure is  
not reusable. Keysure is available as a  
system for 100's of keys, and is  
available in blue and clear. Other uses:  
computer access codes/safe  
combinations, etc.

See ad on page 141

**Key Systems, Inc.**  
948 Culver Rd.  
Rochester, NY 14609  
(716) 654-9388  
FAX: (716) 654-7916

Key Personnel: George Eckerdt, Pres.;  
Bruce Fredericks, VP  
Manufacturers of Velcro-backed key  
storage devices consisting of portable  
key cases, file inserts holding up to  
1000 keys in a drawer, metal cabinets  
and electronic key control cabinets.

**Keydex International Inc.**  
P.O. Box 737  
Saddle River, NJ 07458  
(201) 930-9056  
FAX: (201) 930-8641

Key Personnel: Howard A. Osofsky,  
Pres.; Barbara J. Osofsky, Ex. VP  
Manufacturers of Keysaver®.

**Keystone Novelty Co. Inc.**  
137-17 71st Ave.  
Flushing, NY 11367  
(718) 544-1734  
FAX: (718) 544-1872

Key Personnel: Hy Korn  
High quality key rings and accessories.  
Product line includes the lowest prices  
on snap clips, wrist coils, cutters, key  
I.D. rings, key I.D. covers, key I.D. tags,  
bullitts, whistles, knives, tape

measures, lanyards, luggage locks,  
split rings, etc. Free catalog available  
on request.

**KILLEEN SECURITY PRODUCTS  
33 Hermon St.  
Worcester, MA 01610  
(508) 754-1714**

FAX: (508) 723-2183  
Key Personnel: Norman Doucet, Pres.;  
Doug Maston, VP  
Manufacturer of interchangeable core  
products. Interchangeable with Best,  
Falcon, Arrow, Eagle and Lockwood.  
See ad on page 116

**Kinduell Screen Products, Inc.**  
110 Center St.-Wilder  
Newport, KY 41701  
(606) 581-5444

Key Personnel: Carole S. Kinduell,  
Pres.; Rick Donaldson, VP; Scott  
Theissen, Sales Mgr.  
Truck decals, vinyl pressure-sensitive  
pre-spaced lettering and standard in  
stock logo's. Decals are durable,  
weather-resistant and easy-to-apply.  
Kinduell Screen Products, Inc. has been  
in the fleet marking business for over  
30 years. Call or write for your free  
catalog today.

**Knaack Mfg. Co.**  
420 E. Terra Cotta Ave.  
Crystal Lake, IL 60014  
(815) 459-6020, (800) 456-7865  
FAX: (815) 459-9097

Key Personnel: Steve Moore, VP-Sales;  
Rick Bielski, Nat'l Sales Mgr.  
Weather Guard storage boxes, drawer  
units and racks for pickups. Weather  
Guard storage shelves, lockable  
cabinets, parts cabinets, drawer units,  
bulkhead partitions and roof racks for  
vans. Knaack job site storage boxes,  
cabinets, workbenches and work  
stations.

**Knight Safe Mfg.**  
10626 E. Rush St.  
South El Monte, CA 91733  
(818) 350-6087, (800) USA-BILT  
FAX: (818) 350-6154

Key Personnel: Don Moore, Pres.; Dale  
Emmert, Cust. Svc. Mgr.; Art Corona,  
VP Mfg.  
Manufacturers of TL-15, TL-30, 'B' and  
'C' rated money chests. Custom  
designed chests for commercial and  
bank equipment dealers. Dealer sales  
only.

**KUSTOM KEY INC.**  
1010 Aviation Drive  
Lake Havasu City, AZ 86403  
(800) 637-5397, (602) 453-8338  
FAX: (602) 453-8733

Key Personnel: Dave Vedder, Pres.;  
Michael Vedder, GM  
The Kustom Key manufacturing  
facility located in Arizona, produces  
key blanks in a variety of head shapes.  
All are available in over 500 keyways.  
They may be purchased factory direct  
by locksmiths at reasonable prices. All  
blanks are available in first quality  
brass or nickel-silver and will meet or  
exceed original manufacturer  
specifications. Customer service is

excellent and all blanks are 100%  
guaranteed.

See ad on page 29

**Kwikset Corporation**  
516 E. Santa Ana St.  
Anaheim, CA 92803-4250  
(714) 535-8111

Key Personnel: John Lang, Pres.; Jack  
Wood, VP-Sales; Steve Price, VP-Mktg.  
Manufacturer of locksets, leversets,  
handlesets, deadlocks and other home  
security products.

**LAB Tools**  
P.O. Box 54

Napco Dr.  
Terryville, CT 06786  
(800) 243-8242, (203) 589-6037  
Key Personnel: Robert A. Labbe,  
Chmn./Pres.; Gerald G. Roraback, VP;  
Crosby J. Kelly, VP-Sales/Mktg.  
Manufacturer of color coded  
replacement pins and original  
manufacturers pins, universal pin kits  
and original pin kits, locksmith picking  
instruments and professional tools.

**LATCH-GARD CO., INC.**

P.O. Box 425  
110 South Elkhart  
Wakarusa, IN 46573  
(219) 862-2373  
FAX: (219) 862-2159

Key Personnel: Randall Moyer, Pres.;  
David Geiger, VP  
Latch-Gard's new products for  
complete latch protection. Seven new  
models have been added using special  
fasteners for a cleaner interior look.  
Different model sizes allow for varying  
door and latch application. Models  
available in zinc, duronite or bright  
brass finish. Special jamb pin on  
original models prevent prying of door.  
See ad on page 28

**La Gard Inc.**  
3330 Kashiwa St.  
Torrance, CA 90505  
(213) 325-5670  
FAX: (213) 325-5615

Key Personnel: Larry Cutter, Pres.;  
Susan Gartner, Sales Mgr.

**LCN CLOSERS**  
121 W. Railroad Ave.  
Princeton, IL 61356  
(815) 875-3311  
FAX: (815) 875-3222

Key Personnel: W.W. Martin, Mktg.  
Dir.; P.J. McCormick, General Sales  
Mgr.  
ANSI Grade One architectural door  
closers, Sentronic Series life safety  
closer/holders, concealed and surface  
mounted security closers, door controls  
that meet the newest accessibility codes  
for use by people who are  
handicapped.  
See ad on page 168

**LIBERTY SAFE AND  
SECURITY PRODUCTS INC.**  
316 W. 700 S.  
Provo, UT 84601  
(800) 247-5625  
FAX: (801) 373-9525  
Key Personnel: Jay Crosby, Pres.



**Liberty Safe & Security Products Inc.**

Continued from page 52

Liberty Safe and Security manufactures 11 distinctive models of the most technologically advanced home safes in the world...safes that are not only secure, but attractive, functional, and affordable as well. We offer the highest standard of quality at an affordable price.

See ad on page 59

**LIFETIME AUTO. PROD., INC.**

5000 Quorum Dr., Ste 600  
Dallas, TX 75240

(214) 392-2886  
FAX: (214) 392-2411

Lifetime Automotive Products markets the award-winning Spare Key Locking Gas Cap™. This ingenious gas cap has a secret compartment where motorists can store spare keys so they'll never lock themselves out of their car. The compartment is protected by a Presto® combination lock. Locksmiths have been selling it successfully nationwide.

See ad on page 144

**Lifetime Products**

Rt. 78 South  
Kewanee, IL 61443  
(309) 853-3387

FAX: (309) 853-3389

Key Personnel: Jean Kaine, GM; Jim Themanson, Mktg. Mgr.; Lanny Hulslander, Sales Mgr.

Lifetime's lift-a-load elevating platform trailer raises the load from the ground up to 54" high. Ideal for delivering safes, ATM's and vault doors. 4,000 lb. to 15,000 lb. capacities.

**Lindustries, Inc.**

21 Shady Hill Rd.  
Weston, MA 02193  
(617) 237-8177

Key Personnel: Willard H. Lind, Pres.; Louise T. Lind, VP

Lindustries, Inc. manufactures for distributors and locksmiths Leveron, a product that converts all standard doorknobs to lever action. Leveron is installed without removing in-place hardware and has no visible means of fastening. Code complaint, Leveron has Veterans Administration approval and was designed to address ADA requirements.

**Litton Poly-Scientific**

1213 N. Main St.  
Blacksburg, VA 24060  
(800) 336-5917 (Sales)  
(800) 336-8855 (Technical Services)

FAX: (703) 953-1841

Key Personnel: Robert C. Sterrett,  
Nat'l. Sales Mgr.

Manufacturer of Terminus® Perimeter Intrusion Detection System including our shock sensors for windows, walls, fences, safes, vaults, display cases and ATMs, available in standard or recessed models. New additions to the Terminus family are our lines of audio discriminators and piezo sensors. Also manufacture the SuperVision® access control and alarm monitoring system.

**Lock Corporation of America**

Hwy. 14 North  
P.O. Box 71

Viroqua, WI 54665

(608) 637-8428

FAX (608) 637-8427

Key Personnel: Thomas Rust, GM;

Karan Olson, Office Mgr./Inside Sales Mgr.

Lock Corporation of America manufactures torsion tumbler cylinder (double-sided key) and multi-lever (flat key) locks. The following styles are available: cam, drawer, cabinet, push and locker locks.

**Lock Supply Co., Inc.**

3615 N. 7th St.

Phoenix, AZ 85014

(602) 263-5286, (800) 525-3131 (W)

FAX: (602) 241-0249

Key Personnel: Alex Ebrahmzadeh,  
Pres.

Large selection of locks, parts, key machines and safes.

**LOCKNETICS SECURITY ENG.**

560 Birch St.

P.O. Box 9337

Forestville, CT 06010

(203) 584-9158

FAX: (203) 584-2136

Key Personnel: James Scott, Pres.;

George Nortonen, VP-Mktg./Sales;

Koleen McCauley, Cust. Svc. Mgr.

Locknetics Security Engineering designs, manufactures and markets a broad line of electromagnetic and electro-mechanical security and door control systems. Our new generation of electronic security systems sets a worldwide standard for strength, precision and performance and is used to produce a variety of security and life safety solutions in museums, hospitals, schools, airports, factories, office buildings, retail stores and government facilities.

See ad on page 19

**LORI LOCK, DIVISION OF INT'L SECURITY PROD.**

Old Turnpike Road

Southington, CT 06489

(203) 621-3605

FAX: (203) 621-5972

Key Personnel: Andy Meade, Pres.;

Den Theriault, VP Op.; AJ Meade,

Nat'l. Sales Mgr.

Manufacturers of solid brass mortise, rim and insert cylinders, mortise cylinder deadlocks, Jimmy-proof deadlock, super blocker, mailbox and cabinet locks.

See ad on page 36

**Lucky Line Products, Inc.**

7890 Dunbrook Rd.

San Diego, CA 92126

(619) 549-6699 (CA),

(800) 654-6409 (Nat'l)

FAX: (619) 549-0949

Key Personnel: Ray Howard, Pres.; Jan Howard, Mktg. Coord.; Dawny Alsop, Cust. Svc.

Lucky Line Products, Inc. is a leading supplier of popular key rings and key accessories. Included in their product line are the Twisty, Fix-O-Loc, Secure-A-Key and I.D. key rings.

**LUND EQUIPMENT**

P.O. Box 213

Bath, OH 44210

(216) 659-4800, (216) 659-4128

FAX: (216) 659-9347

Key Personnel: E. Howard Lund

Over 50 years of producing key control systems, offering more than 70 different styles. Also offering built-to-order key cabinets to your specifications.

See ad on page 51

**M.A.G. Eng. & Mfg. Inc.**

15261 Transistor Lane

Huntington Beach, CA 92649

(714) 891-5100, (800) 624-9942 (except CA)

FAX: (714) 892-6845

Key Personnel: Howard M.

Allenbaugh, Pres.; Fred F. Pannebaker,

VP-Sales/Mktg.; John Sobczak, Sales

Coord.

M.A.G. security products enable you to repair and reinforce doors instead of replacing them. You'll save money and time, while improving door strength and appearance. Also, a new line of sliding patio door locks, heavy duty sliding window locks, and miscellaneous security items for doors and windows.

**MAGNOKROM INC.**

171 nugget Ave.

Scarborough, Ont. M1S 3B1 Can.

(416) 299-0000

FAX: (416) 299-3728

Key Personnel: Edward Milic, Pres.

Manufacturers of panic exit devices, surface bolts, fire rated, available in aluminum.

See ad on page 83

**Major Metalfab Co.**

370 Alice St.

Wheeling, IL 60090

(708) 537-7890, (800) 323-8181

Key Personnel: Rob Fosness, Dir.-Sales  
MMF industries manufactures a full line of key control products. Single tag and two tag systems are available in cabinet, drawer, key rack and key board styles. Key capacities range from 10 to 715 keys. In addition, MMF manufactures coin and cash handling supplies, signs and writing instruments.

**MARKAR PRODUCTS, INC.**

12715 Lewis Rd.

Akron, NY 14001

(716) 542-3001

FAX: (716) 542-9336

Key Personnel: Stanley R. Tatara, Pres.;

Thomas J. Frys, VP; Kevin Hamilton,

Nat'l. Sales

Markar Products, Inc. manufactures of the patented reinforcing pivot, aluminum continuous hinges and fire-rated steel and stainless steel continuous hinges. Both pivots and continuous hinges are used in contract, retrofit, hospital, school and security applications.

See ad on page 110

**Marks USA**

5300 New Horizons Blvd.

Amityville, NY 11701

Continued on page 56



## The Innovation You Expect, with the Flexibility You Need!

[Click here for more information](#)

*Continued from page 54*

(516) 225-5400 (800) 526-0233

FAX: (516) 225-6136

Key Personnel: George Marks, Pres.;  
Sheila Rosenberg, VP Sales and Mktg.  
Manufacturer of mortise, cylindrical and  
tubular locksets for residential and  
commercial application; mortise dead-  
locks, tubular deadbolts, gate locks and  
mortise locks for ornamental iron doors.

### **Marlee Electronics, Corp.**

2501 S. Front St.

Philadelphia, PA 19148

(800) 874-8036

FAX: (215) 755-7877

Key Personnel: B. Scott Holloway,  
Pres.; Kelly Lyman, Sales Doord.; Chas.  
Tevis, Svc. Mgr.

Manufacturer of Entraguard products.  
Advantage, LCD, PM5, PM4 telephone  
access systems combined with or  
separate from card access systems.  
LCD and EntraKey are now available.

### **MARLOK COMPANY**

4200 W. Diversey

Chicago, IL 60639

(312) 283-2005

FAX: (312) 283-4861

Key Personnel: Jerry Welch, GM; Dale  
Reynolds, Technical Support

For over 10 years Marlok has been  
supplying access control products to be  
used in a wide variety of applications.  
Marlok offers hardwired as well as stand-  
alone type systems. The ML-9000 is  
known world wide as the premier locking  
system for hotel/motel security.

**See ad on page 106**

### **MAS HAMILTON GROUP**

805-D Newton Circle

Lexington, KY 40511

(606) 253-4744

FAX: (606) 253-4748

Key Personnel: G.L. Dawson, Pres.; J.D.  
Hamilton, Exec. VP-Sales/Mktg.; Tom  
Cassada, VP Eng.

The Mas-Hamilton X-07 electronic  
combination lock.

**See ads on pages 23, 25**

### **Master Lock Co.**

P.O. Box 10367

Milwaukee, WI 53210

(414) 444-2800

FAX: (414) 444-0322

James Beardsley, Pres.; Jim Dargan,  
VP Sales; Bob Weis, Dir. Mktg. Door  
Hdw. Div.

### **Lloyd Matheson Inc./Lockwood**

P.O. Box L

Charlestown, NH 03603

(603) 826-5777

FAX: (603) 826-4186

Key Personnel: Lloyd J. Matheson, Sr.,  
Pres.; Alex Matheson, VP; David  
Colburn, Mgr.

Lloyd Matheson Inc. produces high  
quality architectural hardware under  
the "Lockwood" trade name. The  
product line includes a non-corrosive  
mortise lock, heavy duty cylindrical  
lock, key 'n' lever lock, removable  
cores, tubular and mortise deadbolts,  
asylum lock and Lockwood master key  
systems. The Lockwood tradition dates  
back to 1878.

*Continued on page 58*



Continued from page 56

**MCDOWELL-CRAIG**  
13146 Firestone Blvd.  
Norwalk, CA 90650  
(213) 921-4441  
FAX: (213) 921-9648

Key Personnel: Steven Craig, Breng McDowell, VP

These Swing-A-Way Security Bars are specially designed and manufactured for the explicit purpose of preventing surreptitious entry in filing cabinets and desks. Simple to install and easy to operate, these bars permit the use of adjoining filing cabinets whether in the open or closed position.

See ad on page 140

**McGard Special Products Division**

3875 California Rd.  
Orchard Park, NY 14127  
(716) 662-8980 (800) 699-6887  
FAX: (716) 662-8985

Key Personnel: Peter Fleischer, Sales Mgr.; Mike Reilly

Manufacturers of specialized asset security products. Examples are fire hydrant locks, manhole cover locks, meter locks and other varied applications to fit individual needs.

**McGunn Safe Co.**

6401 W. 65th St.  
Chicago, IL 60638  
(708) 458-7233

FAX: (708) 458-3323

Key Personnel: Patricia S. Johnson-McGunn, Pres.; Edward T. McGunn, Chrmn.; Michael McGunn, Mgr.

McGunn Safe Company has been designing and building safes for over 51 years. We specialize in safes to handle cash for retail businesses. Our color-coded safes have helped many stores eliminate improper handling of cash during shafts. We also build cash till safes, firesafes, truck safes and home safes.

**MDM Prod. Hdw. & Auto Accessories.**

243 Londonderry Lane  
Getzville, NY 14068  
(716) 689-0324

(716) 688-7732

Key Personnel: Edith Mitchell, Office Mgr.; Greg Augustinkia, Mktg. Rep.; Wilma McCray, Sales Rep.

New door hinge repair kit for residential and commercial doors for 3 to 4-1/2" hinges. No need to replace doors. Strengthens the hinge area of the doors.

**Medeco Security Locks, Inc.**

P.O. Box 3075  
Salem, VA 24153  
(703) 380-5000

FAX: (703) 380-5010

Key Personnel: Tim Layton, Pres.; Mike Tetreau, VP-GM

Medeco Security Locks, Inc. manufactures high security locks and lock cylinders. The Biaxial lock design offers key control, masterkeying, pick and drill resistance, and is U.L. listed and patented. Medeco offers locks to a wide variety of industries, including institutions, residential, business and OEM applications.

**Meilink Industries, Inc.**

6245 Industrial Pkwy.  
Whitehouse, OH 43571  
(419) 877-5352

FAX: (419) 877-5223

Key Personnel: Edward Palisin, Chief Exec. Off.; Jerry Williams, Nat'l Sales Mgr.

Supplier of complete line of quality home safes, record safes, data safes and composite burglary/fire resistant safes. Also, complete line of fire resistant vertical and lateral files for home and office. Data Plus models available for EDP software protection. Complete line of accessories for files and safes.

**MEISTER ATLANTA CORP.**

3673 Clairmont Rd.  
Atlanta, GA 30341  
(404) 4511-9700

Key Personnel: Harry Detlefs, Pres.; Renate Detlefs, Sec'y.

Heavy duty strike plates H1280 and 2000.

See ad on page 15

**Merit Metal Products Corp.**

242 Valley Rd.  
Warrington, PA 18976  
(215) 343-2500

FAX: (215) 343-4839

Key Personnel: Adam Stefanowicz, Nat'l Sales/Mktg. Mgr.

We are manufacturers of brass replacement cylinders, mortise and rim. We also manufacture specialty locks such as gate locks and sliding or pocket door locks. Finally, we make a full line of solid brass decorative hardware for windows and doors including hinges, door stops, etc.

**Micro Timer & Controls Inc.**

2603 NE 17 Terrace  
Gainesville, FL 32609  
(904) 377-1946, (800) 438-1630

Key Personnel: Dan Hargrove, Sales Mgr.

Manufacture of time controllers. All timers work in the event of AC power failure. System Four timer used for access control, automatic arming of alarm systems, and control of door strikes or releases. Sav-A-Guard® is used to monitor security guards as their rounds are made. If a guard does not perform duties properly, a signal is sent to a central station.

**Miwa Lock, Canada**

Box 3708 Station 'D'  
Edmonton, Alberta T5L 4J7  
(403) 453-5226

FAX: (403) 452-7551

Key Personnel: Gary J. Mozak, Sales Mgr.

Miwa Lock's combined high technology cylinder with a full line of rugged hardware is a proven combination of restricted key security with old-fashioned virtues such as durability, reliability, and quality manufacturing. Miwa Lock products using advanced technology like the EC cylinder, utilizes coded magnetic fields while the EX cylinder is a unique hybrid that insures maximal security through the combination of both

magnetic and pin cylinder construction.

**MIWA LOCK, USA**

71 N. Peco's Suite 106  
Las Vegas, NV 89121  
(702) 882-9554

FAX: (702) 452-9330

Key Personnel: Will Schaff, Bob Schaff  
See ad on page 47

**MK Systems of Houston**

10914 Ashcroft Dr.  
Houston, TX 77096  
(713) 723-2995 (713) 723-4622  
FAX: (713) 723-4622

Key Personnel: Lloyd Howard White, CM; Winfield Scott White, Asst.

Professional locksmith software, ready-made charts, all types of masterkey products. Latest and up-to-date video and printing software including laser. Samples on request MSDOS. Fast service on disks and charts.

**Monarch Hardware & Mfg. Co.**

805 N. Buckman St.  
Shepardsville, KY 40165  
(800) 826-5792, (502) 543-2281  
FAX: (502) 543-3089

Key Personnel: W.G. Porter, Pres.; Bob McGehee

Monarch manufactures a complete line of dependable panic and fire exit hardware and accessories. All finishes available for quick shipment, one device or large stocking orders. Monarch also manufactures a complete line of door closers available immediately from stock.

**Monarch Tool & Mfg. Co.**

105 East 4th St.  
Covington, KY 41011  
(800)462-9460 (606) 261-7403

Key Personnel: Pete Bigner, VP Sales; Norman Martin, Corp. Admn.

We carry and manufacture a complete line of high security coin boxes, locks and extensions for all types of laundry equipment, including: Medeco, Duo and Ace. Family owned and operated since 1903, specializing in 100% American-made products.

**The M.K. Morse Company**

P.O. Box 8677  
Canton, OH 44711  
(216) 453-8187

FAX: (216) 453-1111

Key Personnel: M.K. Morse, Pres.; John F. Comune, Exec. VP; Cliff Williams, Sales Mgr.

Founded in 1962, The M.K. Morse Company manufactures a broad range of cutting tools, including band saw blades, hacksaw blades, hole saws, abrasive wheels, mounted points, and the patented Real McCoy hole saws with built-in arbors. Two of M.K. Morse's newer lines are depressed center wheels and reciprocating and sabre/jig saw blades.

**Mosler**

1561 Grand Blvd.  
Hamilton, OH 45012  
(513) 867-4000

Key Personnel: A.M. Marzano, Pres.;



J.J. Pilcher, VP/GM-Phy. Security Div.;  
R. Randolph, Prod. Mgr.  
Mosler Inc., founded in 1867 and  
headquartered in Hamilton, Ohio, is a  
leading supplier of physical and  
electronic security systems, products  
and services to the financial,  
commercial and government  
marketplaces. Among its products are  
UL listed vaults, vault doors, safe  
deposit boxes, record, money and data  
safes, and a complete line of electronic  
security monitoring, access control  
closed circuit television, and drive-in  
banking systems.

**MRL, Inc.**  
7640 Fullerton Rd.  
Springfield, VA 22153  
(800) 989-9891  
FAX: (703) 569-0196  
Key Personnel: Carlton Moorefield, Jr.,  
Pres.  
Manufacturer of quality electronic  
security and access control systems  
since 1969. Products include: Crypto  
Code stand-alone access control  
systems; Entrodyne DIAM 50-3 line  
monitoring equipment; Sound Alert  
audio discriminators.

**Mul-T-Bolt Corp.**  
54-45 44th St.  
Maspeth, NY 11378  
(800) 622-5625, (718) 392-9000  
Key Personnel: Mark Berger, Nat'l  
Sales Mgr.  
A Division of Securitech Group, Inc.,  
Mul-T-Bolt Corp. manufactures 100%  
American made four-point door

locking systems. Recently introduced  
the lock industry's first security exit  
device, the Series 8000 panic exit  
deadlock system, all bolt, no latch.  
Listed by UL.

**Multi Lock Inc.**  
P.O. Box 3148  
Marathon Shores, FL 33052  
(305) 743-2328  
FAX: (305) 742-2703  
Key Personnel: Jerold R. Ford, Pres.;  
M.E. DePalma, VP; Clarence Fulton,  
Plt. Mgr.  
Multi Lock Inc. was incorporated in  
1955 and began manufacturing the rust  
proof wire door gate lock in 1968. The  
lock is completely non-ferrous and  
may be used in ornamental iron gates  
as well as wire mesh door gates. Using  
only three moving parts the lock is  
totally flexible and can hinge or slide  
left or right.

**MULTI-LOCK CORPORATION**  
P.O. Box 2996  
2027 Harpers Way  
Torrance, CA 90501  
(213) 320-6400  
See ad on page 145

**Mul-T-Lock USA Inc.**  
300-1 Route 17 South, Ste. A  
Lodi, NJ 07644  
(201) 778-3222, (800) 562-3511  
FAX: (201) 778-4007  
Key Personnel: Offir Asher, Nat'l Sales  
Mgr.; Joe Levy, Door Mktg. Mgr.; Avi  
Efrati, Mkg't Dir.

**Mul-T-Lock Corp.**  
54-45 44th St.  
Maspeth, NY 11378  
(800) 622-LOCK, (718) 392-9000  
Key Personnel: Mark Berger, Nat'l  
Sales Mgr.  
Manufacturer of multiple-point locking  
systems with standard keyways or  
Medeco cylinders. 100% made in  
U.S.A. UL listed. New model 4100  
requires no special tools for 2-3/4"  
backset installation in hollow metal  
doors. Security locks for security  
professionals.

**NATIONAL CABINET LOCK**  
200 Old Mill Rd.  
P.O. Box 200  
Mauldin, SC 29662  
(803) 297-6655  
FAX: (803) 297-9987  
Key Personnel: Dave Bowers, VP/GM;  
Larry Roddy, Prod. Mgr.; Bob Phillips,  
Nat'l. Sales Mgr.  
Under the registered trade name of  
"Stock Locks," National Cabinet Lock  
offers over 675 packaged stocking units  
of pin tumbler, disc tumbler and lever  
tumbler products. They also provide  
original brass key blanks as well as  
other locksmith products.  
See ad on page 121

**THE NATIONAL LOCKSMITH**  
1533 Burgundy Pkwy.  
Streamwood, IL 60107  
(708) 837-2044  
FAX: (708) 837-1210

Continued on page 60



**HPC, Inc.**  
**Designing Excellence and Manufacturing  
Quality since 1956**

[Click here for more information](#)



**The National Locksmith**

Continued from page 59

**Key Personnel:** Marc Goldberg, Editor/Publisher; Tom Miodoch, Ad Sales Mgr.; Debbie Schertzing, Ad Sales Publishers of the locksmith's favorite magazine, code books, and technical manuals.

**National Security Safe Co.**

P.O. Box 39  
American Fork, UT  
(800) 544-3829 (801) 756-7706  
FAX: (801) 756-8043

**Key Personnel:** Walt Crosby, Pres.; Glen Nilson, VP

A well established Utah Corporation that originated the triple-wall insulated gun safe. We manufacture 11 different models and custom walk-in vault doors. Oven baked Dupont mirror finishes with real 24 Karat gold finished hardware for the discriminating buyer.

**THE NEW ENGLAND LOCK & HARDWARE COMPANY, INC.**

P.O. Box 544  
South Norwalk, CT 06856  
(203) 866-9283

**Key Personnel:** John S. Hines, Pres.; Jan Brown, Sales/Mktg.  
New England Lock & Hardware Company manufactures the SEGAL brand vertical deadbolt and offers a complete line of bronze or iron rim locks and latches, mortise deadbolts and a full complement of cylinders ranging from simple replacement cylinders to high-security, pick resistant cylinders. All products made in USA.

See ad on page 117

**New Standard Mfg. Co.**

2408 Western Ave.  
Las Vegas, NV 89102  
(702) 385-1132  
FAX: (702) 382-1920

**Key Personnel:** Randy L. Thwing, Pres.; Kathalynn F. Thwing, Sec'y./Treas.

New Standard manufactures highly adaptable brass bodied padlocks which accept original and aftermarket, standard and high security, knoblock cylinders of the Schlage, Arrow, Sargent & Falcon designs. Our interchangeable series accepts i.c. cylinders including Falcon, Arrow, KSP, Best, Russwin, Corbin, Medeco brands. Key retaining and non-key retaining models are available.

**NKL Safe Co.**

1111 Cavalier Blvd.  
Chesapeake, VA 23323  
(804) 485-0200, (800) 528-9900  
FAX: (804) 485-0271

**Key Personnel:** Mike Smith, Pres.; Wanda Smith, GM

Manufacturer of commercial and residential burglar resistant safes and drive-thru window security bars. Providing a full line of money, wall, vehicle, in-floor and roll depository safes carefully designed to meet the needs of both a wide variety of businesses and the homeowner. Specialists in custom designed security products.

**Norden Lock Co., Inc.**

36 J Carlough Rd.  
Bohemia, NY 11716  
(800) 233-LOCK  
FAX: (516) 563-1742

**Key Personnel:** Pete Norden, Pres.  
Norden Lock Co. products include the Norden Police Lock, Secur-A-Door Lock and the Norden Double Door Lock. Distribution is accomplished through major suppliers coast to coast. Recognition and use of our high security locks for commercial and residential applications increases daily.

**Normbau, Inc.**

186 Branham Way  
Mt. Washington, KY 40047  
(800) 356-2920, (502) 538-7386  
FAX: (502) 538-6400

**Key Personnel:** John R. Diedam, GM  
Normbau is a manufacturer and supplier of creative injection molded nylon hardware systems for the hardware trade and for specifications by architects and design engineers.

**Northern Computers, Inc.**

5007 Howell Ave.  
Milwaukee, WI 53207  
(414) 769-5980, (800) 323-4576  
FAX: (414) 769-5989

**Key Personnel:** Jim Vinson, Dir.-Sales/Mktg.  
Access control manufacturing from single door systems to PC based alarm monitoring-access control systems of over 30,000 cards and 700 doors. Products designed to meet the needs of the professional alarm dealer in the 90's and beyond-member ATAPCO Security and Communication Group.

**Norton®**

A Division of Yale Security Inc.  
P.O. Box 25288  
Charlotte, NC 28229-8010  
(704) 283-2101

Norton is the world's largest manufacturer of door controls and closers.

**NUMBERALL STAMP & TOOL CO. INC.**

P.O. Box 187  
High Street  
Sangerville, ME 04479  
(207) 876-3541

**FAX: (207) 876-3566**  
**Key Personnel:** Rick Pellerin, Sales Mgr.

Manufacturer of key marking equipment, and all types of metal indenting, numbering and lettering equipment.

See ad on page 38

**O-Mega Stun Guns**

3544 Overland Ave.  
Los Angeles, CA 90034  
(800) 553-0222 (USA)  
(800) 244-STAR (CA)

**Key Personnel:** Zane Rothschild, Kenny Rich (Owners)  
O-Mega manufactures the highest quality and power stun guns in the world, 45,000-150,000 volts, 5"-18" long. Great locksmith's secondary sales item. Currently sold by hundreds of

locksmiths nationwide. Immobilizes an attacker with a powerful shock. Legal, no license required.

**OEM Mfg. Inc.**

194 Daniel St.  
Hackensack, NJ 07601  
(201) 489-2184  
FAX: (201) 343-7315

**Key Personnel:** Wes Zion, Pres.; Jeff Zion, GM; Ralph Rofolo, Sales Mgr.  
Manufacturer of pins, pin sets, tools, cabinet bars, screw machine parts, springs.

**O'Keeffe's Inc.**

75 Williams Ave.  
San Francisco, CA 94124  
(800) 227-3305 (415) 822-4222  
FAX: (415) 822-5222

**Key Personnel:** Stacy Westhoff, Dir. of Mktg.

O'Keeffe's Inc. has over 52 years of experience manufacturing aluminum building products. O'Keeffe's GPX Glassprotex fire and safety rated door and wall systems offer unrestricted vision areas in fire rated applications. GPX framing systems are not subject to the area limitations of wire glass or ceramic glazing.

**Olympus Lock**

8512 20th Avenue N.E.  
Seattle, WA 98115  
(206) 525-5338  
FAX: (206) 523-9876

**Key Personnel:** E.P. "Marty" Martin, VP Sales/Mktg.

Olympus Lock manufactures pin tumbler commercial cabinet locks. Patented features allow easy rekeying. Olympus locks are available on National, CCL, Schlage, and Weiser keyways. Other keyways can be constructed using conversion plugs. Olympus also produces lock bodies for Best style IC core, Medeco high security and Assa high security cylinders.

**Omnia Industries, Inc.**

P.O. Box 330  
Cedar Grove, NJ 07009-0330  
(201) 239-7272

**Key Personnel:** Alberto R. Comini, Pres.; Fred Marzullo, Prod. Mgr.; John L. Barwick, Sales Mgr.; Denyse P. Comni, Director-Adv./Merch.

Omnia manufactures solid brass builders' hardware since 1964. The company offers entry sets, interior latch sets, narrow stile mortise locks with trim, cremone bolts, surface bolts, door stops, door knockers, switchplates, house numbers, cabinet hardware and bath accessories.

**Optex (USA) Inc.**

363 Van Ness Way, Unit 402  
Torrance, CA 90501  
(800) 966-7839  
FAX: (213) 212-7271

**Key Personnel:** Ned Morioka, Sales Mgr.

**OSI Security Devices**

505 W. Olive, Ste. 757  
Sunnyvale, CA 94086



**OSI Security Devices**

Continued from page 60

(408) 720-0909  
(408) 720-9034

Key Personnel: Keith Clark, VP Mktg.; Michelle Wilson, Sales/Cust. Svc.; Pat Duffy, Nat'l. Sales Mgr.

The OmniLock™ is a self-contained access control system in a rugged door lock. It works with the wireless printer to form a complete system that records the identity and time of entry of 250 individual users, plus provides time scheduling capabilities. Because of its versatile design, the OmniLock is installed in minutes and suits most applications.

**Pacific Security Products**

307 S. Raymond Ave.  
Alhambra, CA 91803  
(818) 570-4655

FAX: (818) 289-2326

Key Personnel: Denise Ambrose, Pres. Manufacturer of fire safes, floor safes, "C" and "B" rated chests, rotary hoppers, depositories. Convenience store safes our specialty. Special quotes available on cash handling systems.

**Pad-Pro Lock Products, Ltd.**

Site 26, Box 26  
RR#1, Windsor Jct.  
Halifax County, Nova Scotia B0N 2V0  
(902) 861-2683, (902) 860-0477

Key Personnel: Rolland Gaudet, Pres.

Pad-Pro, a patented weather protector for padlocks, prevents freezing in the winter months and rusting and corrosion year round. It is made of tough polypropylene and fits padlocks up to 2-1/2" in diameter. Once a padlock is installed in Pad-Pro, Pad-Pro cannot be removed without taking the padlock off.

**PARAGON SECURITY CORP.**

10 Taylor St.  
Freeport, NY 11520  
(516) 546-0855

(800) MR ALARM (outside NY)  
FAX: (516) 546-0873

Key Personnel: A. Harold Wallach, Pres.; Miriam S. Wallach, VP; Sidney Mandelberger, Nat'l. Sales Mgr.

Automotive vehicle security products: expandable 2-wire RF remote control alarm, full features RF remote control starter-interrupt systems. Automotive vehicle security accessories: shock, glass and anti-tow detectors, sirens and door lock modules. Marine alarms and marine accessories. Automatic headlight activators.

See ad on page 86

**S. Parker Hardware Mfg. Corp.**

Parker Drive  
P.O. Box 9882  
Englewood, NJ 07631  
(201) 569-1600  
FAX: (201) 569-1082

Key Personnel: Chas. Silberman, Pres.; Toby Bernstein, VP; Milton Keiser, VP-Op.

Established in 1899 and offering a broad line of quality builder's hardware projects as well as a full line of carded hardware. All goods shipped from inventory in New Jersey.

**PDQ Industries Inc.**

208 E. Main St.  
Brownstown, PA 17508  
(800) 441-9692, (717) 656-4281  
FAX: (717) 656-6892

Key Personnel: Bill Tell, Pres.; Patrick Tell, Exec. VP

Offer complete line of cylindrical, mortise and residential locks in most popular designs, finishes and 23 different keyways. Commercial products are UL listed and comply with ANSI. Keyways available include: Arrow, Corbin, Russwin, Schlage, Sargent, and Falcon. Masterkeyed jobs delivered within three weeks; most stock orders delivered within one week.

**Peerless Sales Co.**

1980 Hawthorne Ave.  
Melrose Park, IL 60160  
(708) 865-8870, (800) 729-0307  
FAX: (708) 865-2941

Key Personnel: Walter Snodell, Pres.; Wm. Brock, Dir. Sales; Frank Briggs, Mktg. Dir.

Peerless manufactures the world's largest and most complete line of television, audio visual, video recorder and closed circuit television accessory products. The many products include security fasteners, security hardware, stands, mounts, carts and brackets for the desk, wall and ceiling.

**Pelco**

300 W. Pontiac Way  
Clovis, CA 93612  
(800) 289-9100  
FAX: (800) 289-9150

Key Personnel: Tom Grogan, VP Sales & Mktg.; Bill Reece, Sales Mgr.

Manufacturer of closed-circuit television systems for security and surveillance. Products include cameras, lenses, remote positioning devices, switches, controllers, monitors, camera housings. Quick turnaround.

**The Penetrator**

7370 Turkey Point Dr.  
Titusville, FL 32780  
(407) 267-0700

Key Personnel: Lew F. Noyes, Jr. CML, Owner; Eleanor M. Noyes, Owner

The Penetrator is alive and well but has a new address. It is the finest safe drilling rig on the market. Its features are lightweight, controlled drilling and a thrust bearing which relieves all pressure from your drill motor. Price has remained the same since 1985. Made in the USA.

**PERMA VAULT/  
BONAFIDE FACTORY PROD.**

P.O. Box 473  
Huntingdon Valley, PA 19006  
(215) 364-0330

Key Personnel: Marvin Sobel, Pres.; Irving L. Plaksin, Exec. VP

Perma Vault cash protection units, in room safe deposit boxes, in wall safes, hopper safes.

See ad on page 106

**Perry Blackburne, Inc.**

354 Pine St.  
Pawtucket, RI 02860

(800)556-7474 (401) 725-1400  
FAX: (800) 447-3779 (401) 725-7611

Key Personnel: Perry Mermelstein, Pres.; Edward Paul, Exec. VP; Lisa Padgett, Dir. Cust. Svc.

Manufacturers and direct importers of key accessories, key rings and related products for the locksmith. Realistic pricing policies. Established almost 40 years under the same ownership. Our line will always make you money. Distributorships available, call today, toll-free or use our toll free fax line.

**PHOENIX INDUSTRIES INC.**

P.O. Box 38  
Linwood, KS 66052  
(913) 723-3203

FAX: (913) 723-3507

Key Personnel: Jeff Coatney  
Since 1979, Phoenix Industries has specialized in the manufacture of a constantly expanding line of high quality door bars.

See ad on page 79

**Photonic Alarm Products, Inc.**

8130 W. 26th Ave.  
Hialeah, FL 33016  
(800) 237-8277

Dade Co. FL: 556-4888  
FAX: (305)558-5092

Gordon Grossman, Pres.; Robert Putrind, GM

Photonic Alarm Products produces the LiteChain, a fiber optic cable which cannot be broken without sounding an alarm. The thin, flexible loop makes it safe and easy to install.

**Pliant Plastics Corporation**

6259 Norton Industrial Center  
Muskegon, MI 49441  
(616) 798-7935

FAX: (616) 798-7525

Key Personnel: Curtis Chambers, Pres.; Frank Breveglieri, Mktg. Mgr.; Tom Bishop, Sales, Spec. Prod.

Pliant Plastics Corporation is a custom injection molder of small engineering grade thermoplastic parts. A patented product named "keyglove" is available in a variety of colors, with space for a logo and/or other advertising. Easily assembled to a key, it customizes, identifies, and classifies.

**POWER ACCESS  
CORPORATION**

P.O. Box 235  
Collinsville, CT 06022  
(203) 693-0751 (800) 344-0088  
FAX: (203) 693-0641

Key Personnel: Nillis Sellman, Pres.; Mike Carlson, Sales Mgr.

See ad on page 24

**Preso-Matic Lock Co., Inc.**

3048 Industrial 33rd St.  
Fort Pierce, FL 34946-8694  
(407) 465-7400

FAX: (407) 461-1050

Key Personnel: Albert C. Sanowskis, Pres.; Mary Ann Sanowskis, Sec'y./Treas.

Preso-Matic pushbutton combination door locks are mechanically operated. Four digit combination locks have 10,000 possible combinations; seven



digit locks have 10,000,000. PM locks can be mastered with six digit masters. Double combination locks operate by combination on both sides of the lock. New narrow style lock for narrow style glass doors.

**Presto Lock Inc.**  
A Franzen Company  
100 Outwater Lane  
Garfield, NJ 07026  
(201) 340-1007  
FAX: (201) 340-2705  
Key Personnel: Eberhard Franzen, Pres.; Carmine Rossi, VP Sales; Tim Mann, Sales  
Combination padlocks for all types of cases and lockers as well as deadbolts for doors and windows. All are resettable without the need of special tools.

**Programmed Marketing, Inc.**  
260 West Ave.  
Stamford, CT 06902  
(203) 353-1200  
FAX: (203) 348-3473  
Key Personnel: Nick Ohnell; Ted Crejtak  
Hudson Lock.

**Quality Hardware Mfg.**  
P.O. Box 927  
12605 So. Daphne Ave.  
Hawthorne, CA 90250  
(800) 345-8819, (213) 757-2281  
FAX: (213) 757-0232  
Key Personnel: Gary Greener, Pres.; Michael Martinez, Sales

Quality Hardware manufactures door trim and architectural builders hardware for commercial buildings. The firm also offers fine residential hardware items.

**R&D Tool Co.**  
7705 R.C. Gorman Ave. N.E.  
Albuquerque, NM 87122-2738  
(505) 828-2664  
FAX: (505) 857-0642  
Key Personnel: Douglas Joosten, RL, Pres.; Ruth Joosten, Sec'y./Treas.  
We have been in business a number of years manufacturing and selling the GM pickset. It will pick and decode all GM side-bar locks. Also have a side-bar set for the Ford 10 cut design lock.

**Reading Body Works, Inc.**  
Hancock Blvd. & Gerry Street  
Reading, PA 19610  
(215) 775-3301, (800) 352-2206 (In PA),  
(800) 458-2226 (Outside PA)  
Key Personnel: Jack O'Donnell, VP-Sales  
Manufacturer of service bodies, stake and platform bodies, crane and aerial bodies, enclosed and walk-thru bodies, pickup caps, pickup and van accessories. Available in corrosion-resistant A-60 galvanized steel or weight-saving aluminum. Exclusive Lectoro Life priming system. Three and five year limited warranties. Distribution network throughout US.

**Redi-Line Generators**  
4301 Kishwaukee St.

Rockford, IL 61109  
(815) 226-3030  
FAX: (815) 226-3148  
Key Personnel: James C. Dunlea, Product Mgr.; Becky Miller, Cust. Svc.  
Redi-Line Electric Generators provide power whenever and wherever you need it. Lightweight rugged design and maintenance free operation insures reliable, plug-in and run performance. With nine models from 350-1600 watts, Redi-Line is the durable on-demand power source for the locksmith industry.

**Reed® Exit Hardware**  
A Division of Yale Security Inc.  
P.O. Box 25288  
Charlotte, NC 28229-8010  
(800) 438-1951, (704) 283-2101  
FAX: (800) 338-0965  
Key Personnel: Charles J. Strauss, Dir-Sales; Don Schuett, Cust. Svc. Rep.; Patricia Reavis, Cust. Svc. Rep.  
Reed® offers a full line of architectural-grade exit devices. The complete line includes the basic 2000 Series Exit Device, the 4000 Series Exit Device with CA405 trim and any of five major keyways, and the architectural-grade 9000 Series Exit Device. Reed is a division of Yale Security Inc.

**Reilor Inc.**  
417 Caredean Dr.  
Horsham, PA 19044  
(215) 956-0550  
FAX: (215) 956-0553  
Key Personnel: Richard Charney, GM; John Holt, VP

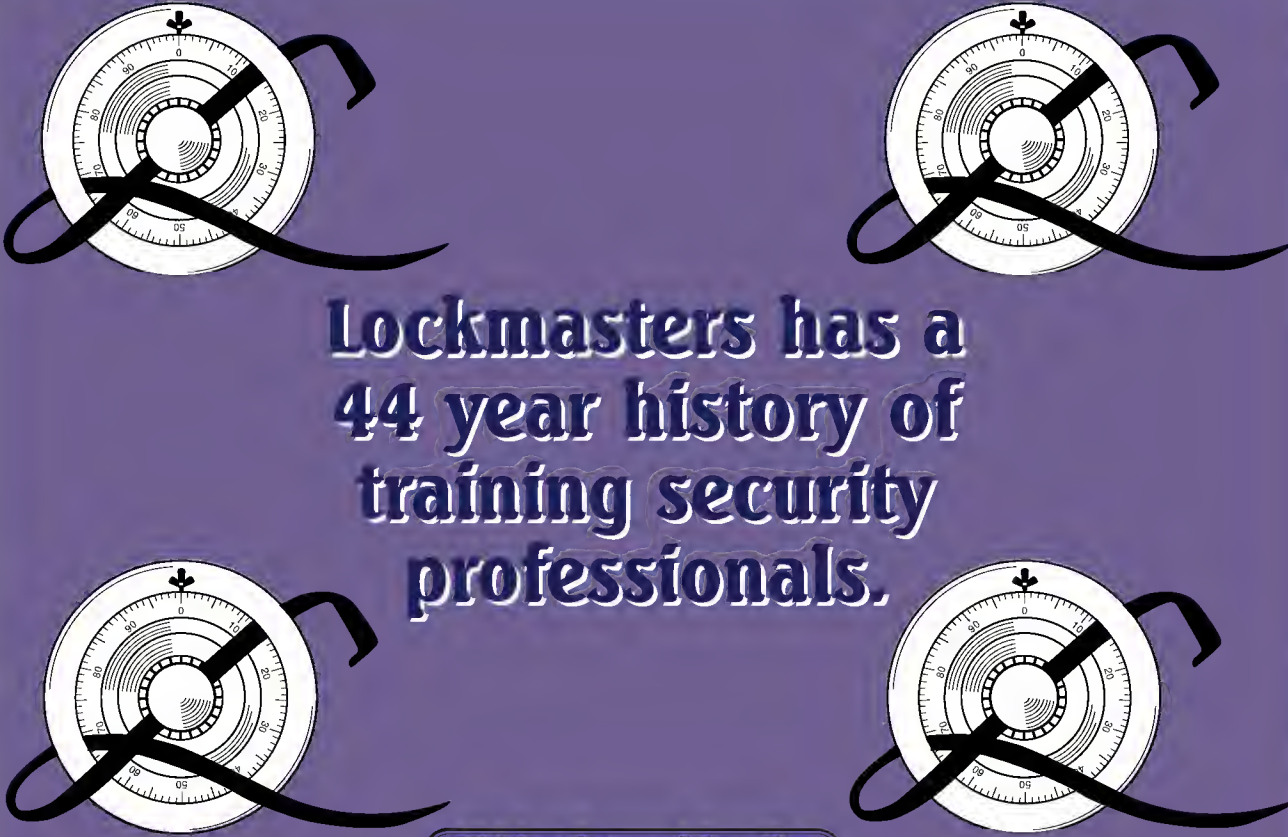

**Lockmasters has a  
44 year history of  
training security  
professionals.**

[Click here for more information](#)



**Reilor Inc.**

*Continued from page 63*

Manufacturer of door closing devices under the "Gibcloser" brand name. Closers for doors up to 150 pounds, UL listed. Easy installation. Manufactures concealed hydraulic closers for doors weighing up to 150 pounds.

**Re-Inforcer Locking Bar**

432 N. Tustin  
Orange, CA 92667  
(714) 633-6520

Key Personnel: Joe J. Adamo

For aluminum stile doors, the Re-Inforcer Lock-Bar System actually joins the door and jamb together as an inseparable unit, and in the case of double doors, joins the doors together.

**JIM RIPLEY'S SERVICES, INC.**

(Safe Monkey Wrench™)

304 S. Lynn Riggs Blvd.  
Claremore, OK 74017  
(918) 341-1077

Key Personnel: Jim Ripley, Pres.

The Safe Monkey Wrench™ is a tool designed to open many high security safes without drilling or manipulation, with minimum damage to the safe. The tool was designed by Jim Ripley, CML, a locksmith specializing in safe openings. Mr. Ripley has also taught safe opening classes.

**See ad on page 38**

**Rixson-Firemark**

A Subdivision of Yale Security Inc

9100 W. Belmont Ave.  
Franklin Park, IL 60131  
(708) 671-5670

FAX: (708) 671-5479

Key Personnel: Robert C. Johnson, Gen. Sales Mgr.; Debbie Crown, Sales Mgr.; Carol Houk, AHC, Mktg. Mgr. Rixson-Firemark offers a full line of industry-leading floor closers, pivots, overhead stops and holders, surface closers, flushbolts, and coordinators. Rixson is a subsidiary of Yale Security Inc.

**Rodann Electronics Mfg. Co.**

3100 Airway Ave. #128  
Costa Mesa, CA 92626  
(800) 366-7010

FAX: (714) 662-3171

Rodann manufactures low cost passive infrared motion detectors designed with state-of-the-art electronic components to insure reliable operation under the most demanding circumstances. Applications include: annunciators, automatic door operation, light controls, customer point of sale display and other special applications.

**ROFU INTERNATIONAL CORP.**

3725 Old Conejo Rd.  
Newbury Park, CA 91320  
(805) 499-0316

FAX: (805) 499-3154

Key Personnel: Len Guyt, VP

Rofu International Corporation stocks for immediate delivery a wide selection of electric strikes, high security electric strikes, electromagnetic locks, switches, lockshields, keyless access control systems and installation hardware.

**See ad on page 167**

**Rollson Industry, Inc.**

3600 Wilshire Blvd., Suite 1732  
Los Angeles, CA 90010  
(213) 386-9188

FAX: (213) 386-8198

Key Personnel: Ralph Wolf, Sales Mgr. Rollson markets a complete line of surface mounted door closers. Service is our Number 1 commitment. Consider Rollson door closers the next time you place an order.

**Rothley Brass**

P.O. Box 429  
501 Railroad St.  
Taylorsville, KY 40071  
(502) 477-8822 (800) 542-7562  
FAX: (502) 477-8831

Key Personnel: Tom Jennings, Pres.; Gary Jouvelakas, VP Sales

**Roton**

Division of Hager Hinge Co.

1115 N. Ellsworth  
Villa Park, IL 60181  
(708) 941-0900

FAX: (708) 941-0113

Key Personnel: Michael A. Overton, Sales Mgr.

Roton manufactures continuous gear hinges which are applied to the full height of door and frame. Made of extruded aluminum alloy, Roton hinges are used in contract, retrofit, school, hospital and security applications for high-frequency doors with weights up to 1000 lbs. supported by shock absorbent, molded bearings.

**Rudolph-Desco Company, Inc.**

580 Sylvan Ave.  
P.O. Box 1245  
Englewood Cliffs, NJ 07632  
(201) 568-4920

FAX: (201) 568-0971

Key Personnel: Hans Bauman, Sr. VP; Michael Simond, VP

"Door Spy," the only four-way door security viewing device letting you see left, right, forward and below your door 90% distortion free up to 20 feet or more. UL approved, patented, registered trademark.

**Russwin Architectural Hardware**

A Black & Decker Co.

225 Episcopal Rd.  
Berlin, CT 06037  
(203) 225-7411

FAX: (203) 828-7266

Key Personnel: John R. Gamble, Pres.; Charles H. Murray, VP Sales; Marilyn A. Burke, VP-Mktg.

Russwin is a full line manufacturer of exit devices, door controls, locksets and key systems.

**Rytan, Inc.**

2908 Oregon Ct., I-5  
Torrance, CA 90503  
(310) 328-6553, (800) 841-3919 (CA),  
(800) 447-9826 (Nat'l.)

FAX: (310) 212-6002

Key Personnel: Mike Sopko, Pres.; Carol Silbaugh, Mktg.; Marilyn Detloff, Cust. Relations

Key machine manufacturer, lock picks, hand tools.

**Safe Corporation**

1779 Valtec Ln.  
Boulder, CO 80301  
(303) 444-5023

FAX: (303) 440-0428

Key Personnel: Brian Hambleton, Pres.; Lorraine Hambleton, VP-Sales

Safe Corporation manufactures a complete line of Aanon burglary safes with the "Safetron" electronic lock, combination or dual key lock. Safe Corporation is a UL approved facility and builds Eagle TL-15 and TL-30 bank and jewelry safes. Customizing safes with teller lockers, depositories and various inner compartments is accomplished quickly through the "FasTrac" design and production system.

**Safe N' Ready**

1951 Plaza Real  
Oceanside, CA 92056  
(800) 321-7606

FAX: (619) 758-7659

Key Personnel: Joseph Kueneman, Pres.; Anthony Benites, Sales & Mktg. Mgr.

Manufacturers of the Port-A-Safe and other quick access firearm safes for handguns and rifles, all with the Simplex pushbutton locking system.

**Safe-O-Mat Coin Locks**

4408 Dunham Dr.  
Minneapolis, MN 55435  
(612) 927-6103

FAX: (612) 926-9502

Key Personnel: George Lundegard, Sales Mgr.

Quick and easy-to-install Safe-O-Mat Coin activated "deposit" locks come in two styles "coin return and coin collect." Designed for steel or wood lockers and installed in the same manner as built-in combination or key locks.

**SAFETY TECHNOLOGY**

2306 Airport Rd.  
Waterford, MI 48327  
(800) 888-4784

FAX: (313) 673-1246

Key Personnel: Margie Gobler, VP; John Taylor, Nat'l. Sales; Lori Lynn Taylor, Dir. of Mktg.

**See ad on page 126**

**SanBar Technologies, Inc.**

P.O. Box 41625  
Santa Barbara, CA 93140  
(805) 564-6931

Key Personnel: Fred A. Barbaria, Pres.

SanBar Technologies manufactures the ProxiKey™ System, a proximity single door access control system for up to 32 users. System user individually coded, individually controlled proximity keys.

**C.E. Sanders**

P.O. Box 2148  
Bunnell, FL 32110  
(904) 437-5222

Key Personnel: Calvin Sanders, Owner; Carol Sanders, Sec'y.

We manufacture our own patented products (established 1983), Hide-That-Key™, Portable Privacy Lock (travel lock), Thumb Square™, Keyholders

*Continued on page 66*



**Reilor Inc.**

*Continued from page 63*

Manufacturer of door closing devices under the "Gibcloser" brand name. Closers for doors up to 150 pounds, UL listed. Easy installation. Manufactures concealed hydraulic closers for doors weighing up to 150 pounds.

**Re-Inforcer Locking Bar**

432 N. Tustin  
Orange, CA 92667  
(714) 633-6520

Key Personnel: Joe J. Adamo  
For aluminum stile doors, the Re-Inforcer Lock-Bar System actually joins the door and jamb together as an inseparable unit, and in the case of double doors, joins the doors together.

**JIM RIPLEY'S SERVICES, INC.**

(Safe Monkey Wrench™)

304 S. Lynn Riggs Blvd.  
Claremore, OK 74017  
(918) 341-1077

Key Personnel: Jim Ripley, Pres.  
The Safe Monkey Wrench™ is a tool designed to open many high security safes without drilling or manipulation, with minimum damage to the safe. The tool was designed by Jim Ripley, CML, a locksmith specializing in safe openings. Mr. Ripley has also taught safe opening classes.

**See ad on page 38**

**Rixson-Firemark**

A Subdivision of Yale Security Inc  
9100 W. Belmont Ave.  
Franklin Park, IL 60131  
(708) 671-5670  
FAX: (708) 671-5479

Key Personnel: Robert C. Johnson, Gen. Sales Mgr.; Debbie Crown, Sales Mgr.; Carol Houk, AHC, Mktg. Mgr.  
Rixson-Firemark offers a full line of industry-leading floor closers, pivots, overhead stops and holders, surface closers, flushbolts, and coordinators. Rixson is a subsidiary of Yale Security Inc.

**Rodann Electronics Mfg. Co.**

3100 Airway Ave. #128  
Costa Mesa, CA 92626  
(800) 366-7010  
FAX: (714) 662-3171

Rodann manufactures low cost passive infrared motion detectors designed with state-of-the-art electronic components to insure reliable operation under the most demanding circumstances. Applications include: annunciators, automatic door operation, light controls, customer point of sale display and other special applications.

**ROFU INTERNATIONAL CORP.**

3725 Old Conejo Rd.  
Newbury Park, CA 91320  
(805) 499-0316  
FAX: (805) 499-3154

Key Personnel: Len Guyt, VP  
Rofu International Corporation stocks for immediate delivery a wide selection of electric strikes, high security electric strikes, electromagnetic locks, switches, lockshields, keyless access control systems and installation hardware.

**See ad on page 167**

**Rollson Industry, Inc.**

3600 Wilshire Blvd., Suite 1732  
Los Angeles, CA 90010  
(213) 386-9188  
FAX: (213) 386-8198

Key Personnel: Ralph Wolf, Sales Mgr.  
Rollson markets a complete line of surface mounted door closers. Service is our Number 1 commitment. Consider Rollson door closers the next time you place an order.

**Rothley Brass**

P.O. Box 429  
501 Railroad St.  
Taylorsville, KY 40071  
(502) 477-8822 (800) 542-7562  
FAX: (502) 477-8831

Key Personnel: Tom Jennings, Pres.; Gary Jouvelakas, VP Sales

**Roton**

Division of Hager Hinge Co.

1115 N. Ellsworth  
Villa Park, IL 60181  
(708) 941-0900  
FAX: (708) 941-0113

Key Personnel: Michael A. Overton, Sales Mgr.

Roton manufactures continuous gear hinges which are applied to the full height of door and frame. Made of extruded aluminum alloy, Roton hinges are used in contract, retrofit, school, hospital and security applications for high-frequency doors with weights up to 1000 lbs. supported by shock absorbent, molded bearings.

**Rudolph-Desco Company, Inc.**

580 Sylvan Ave.  
P.O. Box 1245  
Englewood Cliffs, NJ 07632  
(201) 568-4920  
FAX: (201) 568-0971

Key Personnel: Hans Bauman, Sr. VP; Michael Simond, VP

"Door Spy," the only four-way door security viewing device letting you see left, right, forward and below your door 90% distortion free up to 20 feet or more. UL approved, patented, registered trademark.

**Russwin Architectural Hardware**

**A Black & Decker Co.**

225 Episcopal Rd.  
Berlin, CT 06037  
(203) 225-7411  
FAX: (203) 828-7266

Key Personnel: John R. Gamble, Pres.; Charles H. Murray, VP Sales; Marilyn A. Burke, VP-Mktg.

Russwin is a full line manufacturer of exit devices, door controls, locksets and key systems.

**Rytan, Inc.**

2908 Oregon Ct., I-5  
Torrance, CA 90503  
(310) 328-6553, (800) 841-3919 (CA),  
(800) 447-9826 (Nat'l.)  
FAX: (310) 212-6002

Key Personnel: Mike Sopko, Pres.; Carol Silbaugh, Mktg.; Marilyn Detloff, Cust. Relations

Key machine manufacturer, lock picks, hand tools.

**Safe Corporation**

1779 Valtec Ln.  
Boulder, CO 80301  
(303) 444-5023  
FAX: (303) 440-0428

Key Personnel: Brian Hambleton, Pres.; Lorraine Hambleton, VP-Sales  
Safe Corporation manufactures a complete line of Aanon burglary safes with the "Safetron" electronic lock, combination or dual key lock. Safe Corporation is a UL approved facility and builds Eagle TL-15 and TL-30 bank and jewelry safes. Customizing safes with teller lockers, depositories and various inner compartments is accomplished quickly through the "FasTrac" design and production system.

**Safe N' Ready**

1951 Plaza Real  
Oceanside, CA 92056  
(800) 321-7606  
FAX: (619) 758-7659

Key Personnel: Joseph Kueneman, Pres.; Anthony Benites, Sales & Mktg. Mgr.

Manufacturers of the Port-A-Safe and other quick access firearm safes for handguns and rifles, all with the Simplex pushbutton locking system.

**Safe-O-Mat Coin Locks**

4408 Dunham Dr.  
Minneapolis, MN 55435  
(612) 927-6103  
FAX: (612) 926-9502

Key Personnel: George Lundegard, Sales Mgr.

Quick and easy-to-install Safe-O-Mat Coin activated "deposit" locks come in two styles "coin return and coin collect." Designed for steel or wood lockers and installed in the same manner as built-in combination or key locks.

**SAFETY TECHNOLOGY**

2306 Airport Rd.  
Waterford, MI 48327  
(800) 888-4784

FAX: (313) 673-1246

Key Personnel: Margie Gobler, VP; John Taylor, Nat'l. Sales; Lori Lynn Taylor, Dir. of Mktg.

**See ad on page 126**

**SanBar Technologies, Inc.**

P.O. Box 41625  
Santa Barbara, CA 93140  
(805) 564-6931

Key Personnel: Fred A. Barbaria, Pres.  
SanBar Technologies manufactures the ProxiKey™ System, a proximity single door access control system for up to 32 users. System user individually coded, individually controlled proximity keys.

**C.E. Sanders**

P.O. Box 2148  
Bunnell, FL 32110  
(904) 437-5222

Key Personnel: Calvin Sanders, Owner; Carol Sanders, Sec'y.

We manufacture our own patented products (established 1983), Hide-That-Key™, Portable Privacy Lock (travel lock), Thumb Square™, Keyholders

C. E. Sanders

Continued from page 64

(available in black, 24K gold plate and solid 14K gold). Assorted desk accessories.

**Sandstrom Products Co.**  
224 Main Street (Ship)  
P.O. Box 547 (Mail)  
Port Byron, IL, 61275  
(309) 523-2121, (800) 747-1084  
FAX: (309) 523-3912

Key Personnel: James P. Sandstrom, Pres.; Rick J. Hartscock, VP-Mktg.; Pat Morthland, Lubricant Div. Mgr.  
Sandstrom Poxylube® lubricants are low friction, lacquer-like products containing fluorocarbon, molybdenum disulfide and/or graphite pigments. They are designed to prevent corrosion, galling, seizing and fretting.

**Sargent & Greenleaf, Inc.**

One Security Drive  
Nicholasville, KY 40356  
(606) 885-9411  
FAX: (606) 885-3063

Key Personnel: Gary D. Kepler, Sales/Mktg. Svc.; Ned R. Urschel, VP-Sales; Gary R. Murphree, VP-Gov. Business Dev.

Sargent & Greenleaf manufactures Group I 6730 R-Locks and Group II manipulation proof combination locks, vault locks, high security key and combination padlocks which meet military and government specifications. Additional products: environmental padlocks, safe deposit locks, safe handles, dials and rings, access control, mechanical and electronic time locks, and time delay locks.

**Sargent Manufacturing Co.**

100 Sargent Dr.  
New Haven, CT 06511  
(203) 562-2151  
FAX: (203) 776-5992

Sargent offers a variety of door hardware to the locksmith including mortise and bored locks, auxiliary locks, door closers and exit devices.

**Schlage Electronics**

5452 Betsy Ross Dr., Santa Clara, CA 95054  
(408) 727-5170

**SCHLAGE LOCK CO.**

2401 Bayshore Blvd.  
San Francisco, CA 94134  
(415) 467-1100

FAX: (415) 330-5626

Key Personnel: John Swedeen, Peter Arezzini, Ernie Ware  
Schlage Lock offers a full line of affordable security products, including: deadbolts, door locks, Primus, our high security cylinder, and our new Mediterranean Collection.

See ad on page 33

**SCHWAB CORP.**

3000 Main St.  
Lafayette, IN 47903-5085  
(317) 447-9470

FAX: (317) 447-8278

Key Personnel: Peter Neisel, Pres.; Jeff McQueen, Mktg. Mgr.

Schwab manufactures a complete line of UL rated fire resistant insulated

safes and vault doors. These products are designed to protect paper, microforms, and magnetic media from loss during a fire. All Schwab products feature customized interiors designed to meet the user's special storage and protection requirements.

See ad on page 135

**SCOTSMAN SEC. PROD. INC.**

P.O. Box 1260  
Pine Grove, CA 95665  
(209) 296-7777, (800) 321-GARD  
FAX: (209) 296-2515

Key Personnel: Robert R. Irmer, Pres./GM; Elmagene Irmer, Sec'y-Treas./Office Mgr.; William R. Irmer, VP-Sales/Mktg. Mgr.; Maria Irmer, VP/AP Inventory Control Mgr.  
For 20 years, Scotsman has been developing and manufacturing with pride the highest quality products for the locksmith and builders hardware industries. Choice of tubular key machines: 747E, 747X and 747XU. Tubular key blanks. Full line of narrow-stile aluminum storefront high security protection: DorGard I; DorGard II, DorGard III, DorGard IV, DorGard V. New product: protective cylinder ring, CylGard.

See ad on page 87

**Sealeze Corp.**

8013 Whitebark Terrace  
Richmond, VA 23237  
(800) 446-7325

FAX: (804) 743-0051

Key Personnel: Olin V. Hyde, Pres.;

Continued on page 68

**Major**  
MANUFACTURING, INC.

**Installation Tools**

**The Professionals Choice**

[Click here for more information](#)



**Sealeze Corp.**

*Continued from page 68*

Dennis Klisz, Exec. VP  
As the originator of brush seal technology, Sealeze Corp. carries a full line of gasketing and thresholds to complement any door package. Sealeze also manufactures high-quality brush seals for commercial, industrial and residential applications.

**Seco-Larm**

17811 Sky Park, Circle Ste. D&E  
Irvine, CA 92714  
(714) 261-2999  
FAX: (714) 261-7326

Key Personnel: S.M. Hwang, Pres.;  
Michael Black, Gen. Sales Mgr.  
For over 20 years, Seco-Larm U.S.A., Inc. has provided the security industry with quality products for home, office and vehicle, including alarm systems and accessories, switches, RF equipment, AC-adaptors and strobe lights, to name a few. Many Seco-Larm products are backed with a lifetime limited warranty.

**Secura Key**

19749 Bahama St.  
Northridge, CA 91324  
(818) 882-0020  
FAX: (818) 882-7052

Key Personnel: Frank Simon, Eric Bernocco, Sales Mgr.; Gordon S. Morris, Mktg. Mgr.  
Secura Key is a manufacturer of card and keyboard access control systems. Products range from simple stand-alone units to PC-based card reader systems. The Entracomp series features the patented Touch Card slotless card

reader. Touch Card readers are weather and tamper resistant. Custom printed cards and badges, as well as other accessories, are available.

**Secure-It-Inc.**

18 Maple Court  
East Longmeadow, MA 01028  
(413) 525-7039, (800) 451-7592  
Manufacturer of the Kablit™ anti-theft security device for physical security of computers and other office machines. Usually attaches to your equipment without drilling or gluing. Sells for \$49.95. Catalog available.

**Securitech Group Inc.**

54-45 44th St.  
Maspeth, NY 11378  
(800) 622-LOCK, (718) 392-9000  
Key Personnel: Mark Berger, Nat'l Sales Mgr.; Christine Johannes, Customer Svc.  
100% American manufacturer of locksmith-only high security deadbolts, automatic and multiple point locking systems. Featuring Double-Throw 2" deadbolt top rated by consumer reports and the new 1derbolt, 1-1/2" throw deadlock. New panic exit deadlock system is the first four deadbolt UL listed exit device. security locks for security professionals.

**SECURITRON**

1815 W. 205th St. Ste. 103  
Torrance, CA 90501  
(213) 618-0204 (800) 624-5625  
FAX: (213) 618-0144

Key Personnel: Bob Cook, Pres.; Vince Frallicciardi, VP-Mktg.; Scott Baker, Nat'l Sales Mgr.  
Manufacturers of the Magnalock, the rust proof magnetic lock with the stainless steel case, the DK-20+ digital keypad, weatherproof with the versatility to interface with any electric lock; the revolutionary Touch-Sense Bar exit device; power supplies; electric key switch panels; times; and custom control systems.

**See ad on page 14**

**SECURITY 777**

100 S. Hamilton St.  
Chandler, AZ 85224  
(602) 899-7770

**See ad on page 91**

**Security Door Controls**

31280 La Baya Drive  
Westlake Village, CA 91360  
(818) 889-1622

FAX: (818) 889-0281  
Key Personnel: Dave Geringer, VP/Tech. Asst.; Rick Geringer, VP-Cust. Svc.; Gary Thornberg and Kelly Loe

For 16 years, SDC has been manufacturing electric locks for the locksmith industry. Included in the SDC product line are electromagnetic locks, electric bolt locks, electric strikes, digital keypads, power supplies with battery back-up capabilities and a full line of switch control accessories.

*Continued on page 70*

**medeco**®  
HIGH SECURITY LOCKS

**The market leader  
in locking systems for security,  
safety, and control.**

[Click here for more information](#)

Continued from page 68

**SECURITY FASTENER CO.**

3854 Industrial Way  
Benicia, CA 94510  
(707) 746-8025, (800) 227-2424  
FAX: (707) 746-3047

Key Personnel: Rich Ross; Bob Ross, Mktg.  
Manufacturers of all types of tamper-proof fasteners: One-Way, Spanner, Hex and Torx Pin-Socket, Break-away, Tri-Groove, Tamper-proof Nuts, and Sex Bolts; in steel, stainless, brass, and aluminum...and their respective installation/removal tools; bulk, packaged, and assortments.

See ad on page 156

**SECURITY LATCH**

100 Mission Trail  
Cederville, MI 49719  
(800) 633-6622

Key Personnel: Robert Vanderboegh  
Security Latch is used to add extra security to doors and exits equipped with panic exit devices.

See ad on page 92

**Security Manufacturing Corp.**

815 S. Main St.  
Grapevine, TX 76051  
(800) 762-6937

Manufacturer of vertical and horizontal apartment mail boxes, pedestal mail boxes, post office mail boxes for private industry.

**Security West Co.**

2211 E. 69th St.  
Long Beach, CA 90805  
(213) 633-4149 (213) 630-3134  
FAX: (213) 630-8804

Key Personnel: Dick Berreman, CEO; Bill McQuaid, Pres.; Marie Newsom, Cust. Svc.  
Manufacturer of apartment mailboxes for postal and private use. Keykeepers, directories, and locks and keys available.

**Select Products Limited**

P.O. Box 1334  
Kalamazoo, MI 49005  
(800) 423-1174  
FAX: (800) 423-7107

Key Personnel: Peggy Quinn, Admn. Mgr.; Cheryl Bixby, Cust. Svc. Rep.  
Manufacturer of aluminum continuous gear door hinges. Stocked in 83", 85", 95" and 120" lengths in clear and dark bronze in standard and heavy duty. Custom lengths and custom colors available.

**Sensor Engineering Company**

2155 State St.  
Hamden, CT 06517  
(203) 777-7443  
FAX: (203) 776-6780

Key Personnel: Leigh Hickcox, Sales & Mktg. Mgr.  
Encoded cards and keys associated readers, multi-funtion interfaces and decoder/controllers; combination keypad-reader-display units for RS-485 networks, using Wiegard effect technology.

**Sentry Door Lock Guards**

P.O. Box 326  
Dania, FL 33004  
(305) 922-1604

Key Personnel: Michael W. Dorn, Pres.; E. Diana Dorn, Sec'y./Treas.  
Trade names: Flin-Pin, Gard-Z-Em, Stop Thief, Interlock, K-Man, make-door guards for in and outswing doors, sliding door locks, hinge pins, door viewers.

**Sentry Group**

900 Linden Ave.  
Rochester, NY 14625  
(716) 381-4900  
(800) 828-1438 outside NY  
(800) 462-6463 in NYS  
FAX: (719) 381-8559

Key Personnel: Jack Brush, Chmn.; Dick Brush, Pres.; Doug Brush, Exec. VP; Jim Brush, VP Mktg.  
For over 60 years, Sentry® Group has designed and manufactured a complete line of UL classified Fire/Safe® containers for the home and office. Sentry's professional quality products come in a variety of shapes and sizes, depending on your protection needs. All Fire/Safe products are backed by Sentry's after-fire replacement guarantee.

**Serr-Edge Machine Co., Inc.**

4471 W. 160th St.  
Cleveland, OH 44135  
(800) 443-8097, (216) 267-6333  
Key Personnel: Linda Ribar Oakley, Mgr.

Serr-Edge Machine, manufacturers of sharpening equipment since 1940, provides low cost, high quality sharpeners that increase a locksmith's service potential. In just minutes,

Continued on page 72



National Auto Lock Service, Inc. offers a wide range of equipment and services for the Automotive Locksmith. From tools and hard to find key blanks to transponder programming, we can take the mystery out of car service. We accept credit card orders, and can ship COD. Contact us for the latest in automotive technology.

[www.laserkey.com](http://www.laserkey.com)



**Choose S&G Comptronic  
electronic safe  
locks for...security...  
technology...tradition.**

[Click here for more information](#)



**Serr-Edge Machine Co. Inc.**

Continued from page 70

scissors and shears can be professionally sharpened. This service increases customer traffic, and earns repeating profits. Easy and swift operation with professional results.

**Shack'l Shield Brand Hasps**

950 S. Richfield Rd.  
Placentia, CA 92670  
(714) 993-2752

FAX: (714) 993-4783

Key Personnel: Peter Jeanseau, Sales Mgr.

Shack'l Shield® hasp wraps hardened CRS or high-chromium stainless steel around the lock's shackle. Now, a bolt cutter can't get to it. Equally important, Hartwell's advanced hasp completely eliminates the staple and mounts with heavy-duty through-bolts. Available in four models and three sizes including a model that fits most rekeyable padlocks such as Master Lock #29 and American Lock #700 etc.

**Shwayder Co.**

2335 E. Lincoln  
Birmingham, MI 48008  
(313) 645-9511

Key Personnel: Mark Shwayder, Pres.

**Sibes Brass/Iseo Locks**

260 Lambert Suite "K"  
Oxnard, CA 93030

(800) 843-4951

FAX: (805) 988-9493

Key Personnel: J. Harvey Landry, Pres.

**Sierra International**

5755 Cutter Loop  
Byron, CA 94514  
(415) 634-8220

FAX: (415) 634-8220

Key Personnel: Phil Conklin, Pres.

Sierra International is the exclusive marketing company for Potrans International home and personal security products. Products include the All-Purpose Alarm Lock, Doorbell Security System, Home and Travel Security System and Outdoor Wireless Remote Security System.

**Sieveking Products Co.**

P.O. Box 4287  
Rockford, IL 61110  
(815) 874-4030

Key Personnel: Bob Sieveking, Owner; Jane Sieveking, Mgr.  
Manufacturers of Squeeze-Play™, Clamp-King™, Door Core™, E-Z Pull. Locksmithing tools for the professional locksmith.

**SILICA U.S.A. INC.**

9049 Dutton Drive  
Twinsburg, OH 44087  
(216) 487-5454

FAX: (216) 487-5459

Key Personnel: Barney Goldberg, VP-Sales; David Powell, GM  
Silca keys and key duplicating machines featuring nickel plated brass keys, rubber headed keys and high security keys are now available directly from our facility in the US.

See ads on pages 20, 21

Silent Knight Security Systems

7550 Meridian Circle  
Maple Grove, MN 55369

(612) 493-6400

FAX: 493-6475

Key Personnel: Kit Vail, Pres.; Brian Dunn, Nat'l. Sales Mgr.; Cathy Tabor, Mktg. Coord.

2820 16-zone control communicator UL listed downloadable, the "Regency" product line, \*5104 4-zone fire communicator, fuseless, downloadable, SIA and many other formats. 5207 fuseless digital fire control communicator, 5000 entry system, 9000 digital central station receiver, 1521 16-zone supervised wireless RF receiver.

**William Silver & Co., Inc.**

31 Southwick Court South  
Plainview, NY 11803  
(516) 931-0391

Key Personnel: Frank Korange, Pres.; Jerome Goldstein, Sec./Treas.; Elaine Korange, VP

Manufacturers of the Medeco® Biaxial key gauge.

**Simplex Access Controls Corp.**

2941 Indiana Ave.  
P.O. Box 4114  
Winston-Salem, NC 27115-4114

(919) 725-1331

FAX: (800) 346-9640

Key Personnel: Thomas E. Nazziola, VP-Mktg.

Mechanical pushbutton combination access controls, locks and shunt switches.

**SLIDE LOCK TOOL CO.**

P.O. Box 386  
1166 Topside Rd.  
Louisville, TN 37777

(615) 982-6535 In state

(800) 336-8812

FAX: (615) 977-0891

Key Personnel: Doug Selby, Research & Development.

'92 Master Z-Tool Set®. The result of ongoing development, detailing over 685 models from the 1950's right up to the newest '92 showroom models. Complete set includes: Patented stainless Z-tool®, new for '92 Japanese Tool™, AutoBuster Tool™, New for '92 4th edition Z-tool manual, Flex-A-Wedges, and canvas carry-all case. Distributors welcome.

See ad on page 89

**SLS America**

1212 Wood Street  
Philadelphia, PA 19107  
(215) 564-0272

FAX: (215) 564-0276

Key Personnel: Bruce Dearnley, Pres.

We are a North American manufacturer of very high quality safes and hold Underwriter Laboratory ratings for TRTL 30x6 and modular vaults. Our product line also includes Porta Vaults manufactured from UL rated modular vault panels and vault doors.

**Smart Access Inc.**

124 Robin Rd., Ste. 1800  
Altamonte Springs, FL 32701  
(407) 331-4724

FAX: (407) 331-0656

Key Personnel: Mehdi Daryadel, Pres.  
Smart Access manufactures both simple door and multiple door card access systems. Products can be interface to personal computers. The company also offers computer-based badging systems.

**H. Soss & Co.**

5736 West 96th St.  
P.O. Box 45707  
Los Angeles, CA 90045

(800) 521-3008

FAX: (213) 670-0204

Key Personnel: Charles J. Strauss, Dir.-Sales; Ken Wright, Sales Mgr.; Nancy Hericks, Cust. Svc. Adm.

H. Soss & Company offers a full line of architectural-grade hinges and pivots. The complete line includes all types, sizes and finishes. In addition, a full line of electrified hinges as well as "Vanguard" concealed bearing hinges is available. H. Soss is a subsidiary of Yale Security Inc.

**Southern State Technology**

6416 Pembroke Rd.  
Miramar, FL 33023

(305) 989-7735

Key Personnel: Don Barraclough,

Henry Sims

**Specialty Hardware Products Inc.**

321 Ellis Street  
New Britain, CT 06051  
(203) 827-0702

FAX: (203) 827-0598

Key Personnel: Gloria Lavinio; John Lepito, Pres.

Since 1963, Specialty Hardware Products Inc. has been manufacturing steel and aluminum hinges for industrial, commercial, environmental and marine environmental applications. SHP's EZ-3 and EZ-5 hinge kits have a universal fit with installation in 20 minutes. The kits are ideal for heavy, frequently used doors and can carry up to 100,000 pounds.

**SPECO/EMCO/CSI**

1172 Rt. 109  
Lindenhurst, NY 11757  
(516) 957-8700

FAX: (516) 957-9142

Key Personnel: Mel Hulkower, VP Sales; Eric Forman, Sales Mgr.; Angela Caralon, Reg. Sales Mgr.

Look to the future with SPECO audio and video intercoms that interface with electric door locks.

**SPEEDYPIK CORP.**

350 Longwood Ave.  
Boston, MA 02115  
(617) 567-1111

FAX: (617) 277-7777

Key Personnel: William Cimino, Inventor, Locksmith

"Automatic key identification system" identifies client's keys through a self-contained computerized system. Simply program your own keyboard the way you like, then insert client's keys in the universal keyholder and in seconds the exact match is shown on



**Speedypik Corp.**

Continued from page 72

the monitor. The Speedypik will show the hook number and key name.

See ad on page 68

**STANLEY HARDWARE**

480 Myrtle St.  
New Britain, CT 06050  
(203) 225-5111

FAX: (203) 827-5780

Key Personnel: David Loughran, Mktg.; Steve Curran, Sales  
The nation's oldest hinge manufacturer.

See ad on page 65

**Star Key & Lock Mfg. Co., Inc.**

1274 Flushing Ave.  
Brooklyn, NY 11237  
(718) 821-8300

Key Personnel: Herbert G. Stein, Pres.; Lorraine G. Stein, Exhibit Dir.; Harry Stein, Sec'y./Treas.

Star Key is proud to announce a new, revised edition of the company's popular Key Blank Comparative List. Including all of the "Latest Star Additions" to date with the conversion numbers for Iico, National/Curtis, Taylor and Make of Lock.

**Steadfast Manufacturing Co.**

229 Marginal St.  
Chelsea, MA 02150  
(617) 889-3400 (800) DIAL 911  
FAX: (617) 889-2424

Key Personnel: James Fuller, GM; Bob Simeone, Nat'l. Sales Mgr.  
Steadfast Manufacturing Co. manufactures anti-theft device for cars and trucks that have aroused great

interest among locksmiths. The systems are sold nationwide. Its reputation for simple yet highly effective devices, together with good profit margins, have appealed widely to locksmiths specializing in car locks and auto theft repairs.

**STECK MFG. CO., INC.**

1115 South Broadway  
Dayton, OH 45408  
(513) 222-0062, (800) 227-8325

FAX: (513) 222-6666

Key Personnel: Ray Steck  
Steck manufactures a complete set of car door unlocking tools as well as tools to remove car door handles and door trim panels.

See ad on page 129

**Steelman/JS Products, Inc.**

4083 So. Industrial Rd.  
Las Vegas, NV 89103  
(800) 255-7011

Key Personnel: Alan Landru, Nat'l. Sales Mgr.

Steelman/JS Products, Inc. manufactures and distributes various products for the professional under its brand name Steelman™. The products include Bend-A-Light, (high intensity flexible light tools); Brighteyes Headlights, (used for night impressing work, a flashlight when both hands are needed); and a new product, Inspector, a lighted adjustable inspection mirror.

Streamlight, Inc.  
1030 W. Germantown Pike

Norristown, PA 19403  
(215) 631-0600, (800) 523-7488  
FAX: (215) 631-0600

Key Personnel: Ray Sharrah, Sr, VP; Lori Hare, VP-Sales & Mktg.  
Manufacturer of high tech aluminum and thermoplastic flashlights and lanterns. AA aluminum flashlight with push button tailcap. Transformable flashlight-headlamp converts instantly from conventional flashlight to hands-free headlamp. Adjustable beam tilts for task targeting.

**Strong Arm Security, Inc.**

2228 Kenry Way  
So. San Francisco, CA 94080  
(414) 952-7710

Key Personnel: R. Volosing, Pres.; Z. Volosing, Rec. Sec.

Hardplate drilling equipment for opening safes. The razor sharp Strong Arm drill bits are custom ground on a diamond wheel, come in seven sizes and are economically priced. The Strong Arm drill rig is a versatile and time proven unit utilizing the Bosch 1198 drillmotor. The rig is compact.

**Super Coil**

A Division of QMP Enterprises

10 Jason Rd.  
P.O. Box 9  
Phoenix, NY 13135

(315) 695-2000

Key Personnel: Jane Prall, Cust. Svc.  
Super Coil manufactures the popular Wrist Key Coil, Key Coil Fastener and Belt Key Coil. These items allow keys



**STRATTEC™**

**It's your reputation.  
Trust the original.**

[Click here  
for more  
information](#)

**SRI**  
**SECURITY**  
**RESOURCES INC.**

[Click here for more information](#)

**SRI and Tech Train  
Productions are the  
automotive specialists -  
your best source for  
automotive tools,  
manuals, and videos.**



**Super Coil**

Continued from page 74

to be secured to the person reducing the possibility of loss. All products come with a one year guarantee and are great cash register items.

**Superior Lock, Inc.**  
35056 Cordelia Ave.  
Mt. Clemens, MI 48043  
(313) 790-1820  
FAX: (313) 469-3256

Key Personnel: Robert A. Clevio, Pres. Since 1969, Superior Lock, Inc. has manufactured mortise, rim, dummy and thumb turn cylinders to supply the O.E.M. builders' hardware, and locksmith distributor industry. Superior Lock, Inc. cylinders are machined from solid bar brass, precision drilled key cuts and pin spacing interchange with original systems. Manufactured in the USA.

**Supra Products, Inc.**  
P.O. Box 3167  
2611 Pringle Rd. SE  
Salem, OR 97302  
(800) 547-0252  
FAX: (503) 364-1285

Key Personnel: Larry Springgate, Area Mgr.; Jim Young, Mktg. Mgr.; Mark Nevstel, Mktg. Rep. Manufacturer of KeySafes for home and industry. Combination style lockboxes eliminate the need to carry keys. Mortise and cam lock style lockboxes can be integrated into existing master key systems. Also available, Lost Key Service provides for the return of your lost keys. Products are available through wholesale distribution.

**Synergistics Inc.**  
9 Tech Circle  
Natick, MA 01760  
(508) 655-1340 (800) 243-4669  
FAX: (508) 651-2902

Key Personnel: William Tetrick, Pres.; Robert Pogorelc, Sales Mgr. Synergistic manufactures a complete line of access control systems for security products range from our popular ATM vestibule protection systems to distributed processing systems designed to provide access control for an entire building or an entire complex of buildings.

**Systematics**  
A Division of Cardkey Systems, Inc.  
101 W. Cochran St.  
Simi Valley, CA 93065  
(805) 522-5555  
FAX: (805) 526-0064

Key Personnel: James Hunter, GM; Flo Cowden, Mktg. Comm. Mgr. Applications for Systematics products range from single door control of a small shop or business to control up to four doors. The products are truly cost-effective and have been designed for easy installation by professional locksmiths and alarm system installers.

**Tamperproof Screw Co., Inc.**  
30 Laurel St.  
Hicksville, NY 11801  
(516) 931-1616  
FAX: (516) 931-1654

Key Personnel: Lewis Friedman, Pres.; George Friedman, VP; Alaina Picitelli, Sales Mgr.

Tamperproof offers a complete line of corrosion-resistant security screws designed to prevent vandalism and thefts, yet allows easy access to authorized personnel with the matching tools. These screws are virtually impossible to remove without the special matching screwdrivers.

**Taymor Industries Inc.**  
1586 Zephyr Ave.  
Hayward, CA 94544  
(415) 429-0888, (800) 388-9887  
FAX: (415) 429-0397

Key Personnel: Alex Perry, San Francisco, CA-GM; Brian Williams, Vancouver, B.C.-GM; Morris Feldman, Toronto, Ontario-GM Distributors of Builders' Hardware for over 40 years. Lines include: chain door guards, door closers, door push and pull plates, door stops, door viewers, exit devices, door hinges, cabinet hardware, locksets and deadbolts, brass numbers and letters.

**Tech Manufacturing**  
P.O. Box 88  
Rockford, MN 55373  
(612) 477-5270

Key Personnel: Jerry Mattson, Pres. Tech Manufacturing's combination cam lock can easily convert keyed cabinets to combination security by directly replacing a standard 3/4" diameter keyed cam lock. Locks are individually packaged on multi-colored skin packaged display cards. The locks are available in three lengths: 5/8" (K2001-5/8"), (K3001-7/8") and 1-1/8" (K4001-1-1/8").

**Telkee Inc.**  
Route 452  
Glen Riddle, PA 19037  
(215) 459-1100

Key Personnel: Anthony A. Salamone, Pres.; Peter M. Lindley, VP. Sales/Mktg. Telkee is one of the oldest and largest manufacturers of dual tag key control systems. Telkee systems feature a three-way visible cross index system to identify keys alphabetically, by hook number, or key number. Systems are available to hold 20 to 2200 keys.

**Teskey Enterprises Inc.**  
17572 Griffin Lane  
Huntington Beach, CA 92647  
(714) 842-2378  
FAX: (714) 847-0359

Teskey Enterprises is the low price leader in OEM locks, truck body hardware, office furniture hardware and custom hardware tooling and applications.

**Thug Bug of Connecticut, Inc.**  
P.O. Box 1062  
205 Nutmeg Rd., South  
South Windsor, CT 06074  
(203) 282-9220, (800) 666-6106  
FAX: (203) 291-9548

Key Personnel: David Zingle, Pres.; Susan Zingle, VP/Sec'y; James

Morrow, Tech. Mgr. The Thug Bug 3700 remote is a two button three-channel remote which includes starter interrupt, light flashing, valet, status LED, two transmitters, 120 DB siren, and shock sensor. Transmitter range is up to 150'. All Thug Bug remotes carry a limited lifetime warranty.

**Tice Industries**  
2219 N. Vancouver Ave.  
Portland, OR 97227  
(503) 284-0122

**Timtronics Technology**  
P.O. Box 9692  
Canoga Park, CA 91309  
(818) 718-0621  
FAX: (818) 718-6741

Key Personnel: Lesa Conemac, Sales Mgr. Timtronics Technology, manufacturer of the "Knightstick" and "Wedge Alert" alarm systems. The "Knightstick" secures sliding doors and sliding windows. The "Wedge Alert" secures inward opening doors. Both units emit a piercing 85 db audible alarm. These units are battery operated and portable, for home or travel, etc.

**Trans-Atlantic Co.**  
440 Fairmount Ave.  
Philadelphia, PA 19122  
(215) 629-0400  
FAX: (215) 629-1282  
WATS: (800) 523-9956

Key Personnel: Norman A. Millman, Pres.; Bernard Davis, VP We are the oldest (est. 1951) stocking importer of high quality, commercial and residential grade builders and security products from the many outstanding off-shore manufacturers we represent for the USA market. We specialize in locks, deadlocks, rim and mortise cylinders, panic devices, door closers and door viewers.

**Transcience**  
179 Ludlow St.  
Stamford, CT 06092  
(203) 327-7810, (800) 243-3494

Key Personnel: Donald Bosak Manufacturer of low cost, consumer installable supervised wireless systems with monitoring of intrusion, fire, panic, and medical conditions. All systems with "time-life" do-it-yourself instructions.

**TRESKAT USA**  
**Kissimmee, FL 34742-2287**  
**(800) 645-5657**  
**FAX: (407) 870-9696**

Key Personnel: Ray Nazzaro, Pres. Locksmith software developer. Tradenames: CodeMaster, Perfect Master, Keyman, Advantage, Popalok, Kwiky, Belcat.

See ad on page 119

**TRIMCO (Triangle Brass Mfg. Co. Inc.)**  
3528 Emery St.  
Los Angeles, CA 90023-0277  
(213) 262-4191  
FAX: (800) 637-"TRIM"  
Key Personnel: Anita Call, Cust. Svc.



**TRIMCO**

*Continued from page 76*

Mgr.; Angelec Carrillo, Cust. Svc. Supv. TRIMCO is the trade name for Triangle Brass Manufacturing Co., and has been in the business for over 40 years. The manufacturing of high quality door hardware, including UL approved flushbolts, coordinators, push/pull latches and numerous other products and flatgoods is more than a trade. It is our craft.

**Trine Products Corp.**

1430 Ferris Pl.  
Bronx, NY 10461  
(212) 829-4796  
FAX: (212) 792-9127

Key Personnel: Gary Paley, Mktg. Mgr.; Tim Harding, Sales Mgr.; Chris Fein, Mktg. Media Mgr.

Electric strikes, electric strike kits, pushbuttons, bells, buzzers, industrial signaling devices, magnetic door holders, chimes, switching mats, heavy duty and weatherproof pushbuttons, and remote control transmitter and receivers.

**Tru Hone Corporation**

1721 N. E. 19th Ave.  
Ocala, FL 32670  
(800) 237-4663 (904) 622-1213  
FAX: (904) 622-9180

Key Personnel: James Gangelhoff, VP  
Tru Hone has a knife-sharpening system for any size operation. The Tru Hone knife sharpener sharpens both bevels of a knife simultaneously, giving you precision sharpening in less than a minute. With the addition of a HG3 Hollow Grinder, knives kept tapered like new, resulting in easier cutting, better steeling and longer knife life.

**Ultra Hardware Products**

1777 Hylton Rd.  
Pennsauken, NJ 08110  
(800) 426-6379  
FAX: (609) 663-1743

Key Personnel: Dan Carpey, Jill Donaldson, Sandi Feder, Stephanie Conway, Hank Lorscheider, Herb Bregar, Myles Stein, Jim Watson  
Residential and commercial door locks, residential and commercial closers and panic bars, home security hardware, general builder's hardware.

**U.S. Lock Corp.**

77 Rodew Drive  
Edgewood, NY 11717  
(800) 525-5000

U.S. Lock manufactures a complete line of security and architectural hardware especially for locksmiths. The line features everything from padlocks to panic devices and is distributed through U.S. Lock Security Centers, a nationwide network of U.S. Lock authorized dealers.

**U.S. Security Safe Corp.**

3015 Dalores St.  
Los Angeles, CA 90065  
(818) 242-3156

Key Personnel: Phillip Alfeld, Pres.; Larry McCall, VP-Mktg./Sales  
High quality, low cost, fast delivery, dealers only, no direct sales. Complete line of floor safes, TL-15, TL-30, C rate

burglary. Custom safes. U.S. Security dealers sell safes. Also hoppers safes and depository slot safes.

**Valli & Colombo (USA) Inc.**

P.O. Box 245  
Duarte, CA 91010  
(818) 359-2569

Key Personnel: Marinella Formenti, VP/GM

Manufacturer of Valli & Colombo, Forges & Fusital.

**VIGILANTE BURGLAR BARS, INC.**

35 Country Ridge Dr. N.  
Port Chester, NY 10573  
(212) 328-3700  
FAX: (212) 893-7168

Key Personnel: Larry Kaufman, Sales Mgr.

Manufacturers of the Vigilante Burglar Bars as well as a complete line of innovative steel security products. Sold exclusively through locksmith distributors, it is the strongest and most versatile security line available.

**See ad on page 141**

**Von Duprin, Inc.**

2720 Tobey Dr.  
Indianapolis, IN 46219  
(317) 897-9944

(FAX: (317) 879-9302

Key Personnel: Fred Leverhagen, Mktg. Mgr.; Don McAtee, Sales Mgr.

Von Duprin is a manufacturer of door exit hardware and electrical security



**SCHWAB CORP.**

*Fire protection for your vital records.*

**Free freight!!**

**No middle man!!**

[Click here for more information](#)



**Von Duprin, Inc.**

*Continued from page 79*

products and systems for over 75 years.

**WD-40 Co.**

P.O. Box 80607  
San Diego, CA 92138  
(619) 275-1400

WD-40: Lubricant, penetrant, rust preventative, moisture displacer and cleaner.

**Weiser Lock**

6660 So. Broadmoor Rd.  
Tucson, AZ 85746  
(602) 741-6200 (800) 688-5625  
FAX: (602) 741-6241

Key Personnel: Mark Studley, Pres.; Robert Hamernick, Sr. VP, Sales & Mktg.

Over 80 years of manufacturing quality residential door locks.

**Weslock National**

13344 So. Main St.  
Los Angeles, CA 90061  
(213) 327-2770  
FAX: (213) 324-4624

Key Personnel: Jim Gleason, VP Mktg.; Randy Skoglund, Reg. Mgr.; David Kitchen, Reg. Mgr.; Jim Hall, Reg. Mgr.  
Weslock National full line of residential lock sets, deadbolts and entry handles.

**Wilson Bohannon Co.**

621 Buckeye St.  
Marion, OH 43302  
(614) 382-3639  
FAX: (614) 383-1653

Key Personnel: Bill Houck, Pres.  
We manufacture solid brass pin tumbler padlocks.

**Wilson Safe Co.**

3031 Island Ave.  
Philadelphia, PA 19153  
(215) 492-7100, (800) 345-8053  
FAX: (215) 492-7104

Key Personnel: Ray Wilson, VP; Margie Wilson

Wilson Safe imports and distributes a full line of fire and burglar resistive safes. The Diplomat fire safes are tested at 1800 degrees F and come in 16 model sizes. The Reliance safes combine fire protection with solid steel construction. Each Reliance safe combines a 1/2" door with a 1/4" steel body which is encased.

**Yale®**

A Division of Yale Security Inc.

P.O. Box 25288  
Charlotte, NC 28229-8010  
(704) 283-2101

Yale is a full line producer of locks, door closers, exit devices and other hardware products.

**YOUNG BROS. STAMP WORKS**

P.O. Box 75  
Muscatine, IA 52761  
(800) 553-8248

Key Personnel: Jim Young, Pres.  
Young Bros. Stamp Works has manufactured steel letter and figure hand stamps since 1904. Young Bros. also has brass stencils and steel type and holders in stock.

**See ad on page 144**

**Z-Lock Mfg. Co.**

1201 N. Catalina Ave., Box 949  
Redondo Beach, CA 90277  
(213) 372-4842

Key Personnel: Jay S. Derman, Owner; M. Curran, Operations; C. O'Brien, Sales

Computer drive (LOCKETTE/SLOTLOCK), computer case (COMPULOCK), car radio cassette (SoundsOff), video cassette, 280-300ZX T-top, tailgate, gas cap, Corvette hood release latch, spare tier and diesel fuel tanks locks all use tubular cam or cylinder locks. Sourcing for tubular needs in Taiwan.

**Zero International Inc.**

415 Concord Ave.  
Bronx, NY 10455  
(212) 585-3230 (800) 635-5335  
FAX: (212) 292-2243

Key Personnel: Elias Wexler, Pres.; Stephen Petko, Sales Mgr.; Michael Gardner, Plant Mgr.

Zero was founded in 1924. Manufacturer of sealing systems for doors and windows: acoustical, smoke, light, air filtration, fire, handicapped. Manufacturer of saddles including traction tread and nosing. Manufacturer of Unigear continuous hinge.



**ASP - Your Auto Service  
Center for the World**

[Click here for more information](#)

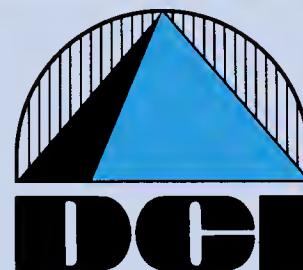

**We have it all.  
Quality, Value,  
& Service**

[Click here for more information](#)

# Distributors

## Absolute Security

9510 Westpark  
Houston, TX 77063  
(713) 977-7233 (800) 880-0787  
FAX: (713) 977-3373

Key Personnel: Terry Cox, Inventor,  
Marketing, Manufacturer

"If you need it; we conceive it." If you have a need, we resolve a solution. Specializing in, but not limited to, the security field. Products to date: most popular safe dials with interchangeable core; Medeco cylinder, also Medeco keyed plunger lock for showcases.

## Accredited Lock Supply Co.

1161 Paterson Plank Rd.  
Secaucus, NJ 07094  
(201) 865-5015  
(800) 652-2835

FAX: (201) 865-5031

Key Personnel: Ron Weaver, Pres.;

Richard Chakov, Nat'l Sales Mgr.

Distributor of locksmith supplies. Complete line of all suppliers. Free delivery of safes in the NY metropolitan area. Access control and other electronic supplies.

## Ace Lock Company

5964 Baum Square Blvd.  
Pittsburgh, PA 15206  
(412) 363-3328

Key Personnel: Sandra Hunter, Pres.;  
Jim Matthews, VP; Jim Jewell,  
Sec'y./Treas.

Distributors of Adams Rite, Arrow, CardKey, Folger Adam, Medeco, Locknetics and others. Specializing in high security and electronic access control.

## ACE LOCKSMITH CO.

53 Brown Ave.  
Springfield, NJ 07081  
(908) 688-7666 (800) 524-1224  
FAX: (908) 688-2442

Key Personnel: Daniel Goldstein,  
Pres.; Robin Cherkes, VP; Stan Gabay,  
Dir.-Mktg./Sales

See ads on pages 40, 115

## Acme Safe Co. Inc.

419 Park Ave. So.

New York, NY 10016

(212) 226-2500

FAX: (212) 686-0736

Key Personnel: David Garbar, Mgr.

## Acme Safe & Lock Service Co., Inc.

2412 Brazos  
Houston, TX 77006  
(713) 522-0868 (800) 451-6561  
FAX: (713) 522-5769

Randy Richards, Gen. Mgr.; Ellen Richards, Purch. Agent; L.B. Kington, Sales

Wholesale suppliers of all major brands of door hardware and locksmith supplies.

## ACME SECURITY SYSTEMS

1922 Republic Ave.  
San Leandro, CA 94577  
(800) 943-2263

FAX: (510) 483-8123

Key Personnel: Steve Harris, Pres.;

John Ream, VP; Bob Weishaar, Sales.

See ad on page 159

## Acme Wholesale Distributors, Inc.

P.O. Drawer 13748  
New Orleans, LA 70185  
(An LSDA Company)  
Local: (504) 837-7315

Branches: Houston, TX (800) 359-2263

San Antonio, TX (512) 545-3396

Mid South: (800) 788-2263

FAX: (504) 837-7321

Key Personnel: Mike Groover, Pres.;

Jay Denniss, Sales Mgr.

Full line distributor of all major lock lines, locksmith supplies, safes, access control, automotive, and LSDA products. Dedicated to service and same day shipping from three locations: New Orleans, Houston, and San Antonio.

## Action Hardware, Inc.

3428-C Vane Ct.  
Charlotte, NC 28206  
(800) 662-6695

FAX: (704) 372-9224

Key Personnel: Brady Woody, GM;

John Healy; Davide Lovett

We are the largest wholesale distributor of Yale and H.B. Ives in the

United States. We also stock Kwikset, Schlage, Rixson, Monarch, Locknetics, and Simplex. We ship until 6:00 Eastern time. Same day shipping on stock orders.

## Adavco Security Products

3340 Tweedy Blvd.  
South Gate, CA 90280  
(800) 235-3159

FAX: (213) 564-9622

Key Personnel: Ralph Davidson

Wholesale locksmith products and manufacturer of Bulldog™ Security Bars. No minimum orders. Order seven days a week. Low prices on popular locksmith products.

## Adams Lock & Safe Co., Inc.

130 Hall St.  
Concord, NH 03301  
(800) 635-2228

FAX: (603) 226-4983

Key Personnel: David C. Holt

## ADI

165 Eileen Way  
Syosset, NY 11791  
(516) 921-6700

Key Personnel: Leo A. Guthart, CEO;  
Steve Roth, Ademco Distribution

ADI offers a complete line of electronic security systems and components, including wireless and hardware equipment. Ademco Distribution has more than 59 convenience outlets offering products of most major manufacturers, including the complete Ademco product line.

## William Aikenhead Door & Hdw. Ltd.

423 Comstock Rd.  
Scarborough, Ontario Canada M1L 2H4

(416) 755-3336

FAX: (800) 265-1100

Key Personnel: Dan Cook, Pres.; Les Eaton, VP; Dave Freeman, GM

Authorized wholesale distributor of Sargent, Stanley, Canadian Builder's Hardware, LCN, Schlage, Von Duprin, as well as Unican products "in stock, in time." We spend our time saving

Continued on page 86

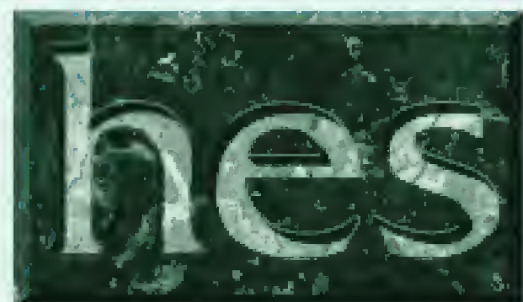

[Click here for more information](#)

**The Innovation You  
Expect, with the  
Flexibility You Need!**



William Aikenhead Door & Hardware

Continued from page 82

you time.

**AKRON HDW. CONSULTANTS**

2579 S. Arlington Rd.

Akron, OH 44319

(800) 321-9602 (Nat'l)

FAX: (800) 328-6070

Key Personnel: Kenneth E. Orihel,  
Sales Mgr.

Western Branch:

2877 N. Nevada Ste. 120

Chandler, AZ 85225

(800) 457-9378 (Nat'l.)

FAX: (800) 457-8773

Akron hardware Consultants is a full-line, specialized wholesale distributor of the following lines: Corbin Architectural Hardware, Russwin architectural hardware, Adams Rite glass door hardware, Rixson architectural and fire/life-safety products, and CCL Security Products. Full line product mix including parts, cylinders, and blanks.

See ads on pages 108, 109

**Allegheny Lock Co. Inc.**

1006-08 Cottman Ave.

Philadelphia, PA 19111

(215) 745-1217

Key Personnel: Bob Mastrangelo, Fred Pfeil, Eddie Pfeil, Sales Dept.

Medeco Security locks and keys-all levels. Same day service: shipping, keying and masterkey systems. Medeco keys cut. Fast service on large quantity our specialty.

**All-Ware Distributing, Inc.**

135 W. 2950 South

Salt Lake City, UT 84115

(801) 487-3227,

(800) 662-6529 (UT),

(800) 453-6430 (Nat'l)

Key Personnel: Jerry Zaharias, Pres.;

Rolf Aase, VP; Larry Clark, Mgr.

We are a complete line distributor of locksmith supplies. We also carry over 150 major lines of locks and supplies. We also rebuild key machines. Minimum order \$25.00. We ship same day if called before noon.

**Allied Locksmith Supply**

P.O. Box 3137

Youngstown, OH 44513

(216) 726-0866, (800) 544-2102

FAX: (216) 726-0865

Key Personnel: Rudy R. Wiesner, Pres.;

Jim Dravec, Oper. Mgr.

**Alno, Inc.**

9725 Owensmouth Ave.

Chatsworth, CA 91311

(818) 882-6028

FAX: (818) 700-1540

Key Personnel: Jack Fase, Pres.; Jessica

Allynn-Smith, Sec'y; Stuart Klein,

Products Inv.

Distributors for our own line of fine decorative hardware/bathroom accessories, switch plates, pulls, escutcheons, house numbers, all in-brass or porcelain and distributors for Kenco, Giorgio, Chicago, Faucet, products lines.

**Alpha Door Controls, Inc.**

207 Sunset Blvd.

Sherman, TX 75090

(214) 868-0099

Key Personnel: Al Gilman, Pres.; Tracy

Gilman, VP

Selling to locksmiths only. Safe drills, electrical components, card readers, electric strikes, Dexter locks, American padlocks, exit devices, kit type burglary alarms, etc.

**AMBASSADOR SAFE CO.**

21 N. Beverywek Rd.

Lake Hiawatha, NJ 07034

(800) 999-5510

FAX: (201) 402-1447

Key Personnel: Jeff Hale, Pres.; Larry

Hale, Sec'y; Karen Hale, Office Mgr.

Ambassador Safe Co. is the direct importer of Ambassador safes which are one and two hour fire safes. Ambassador also stocks a full line of replacement combination and key locks for Korean safes. In addition, we also manufacture "excess cash handling" and "econovault" containers.

See ad on page 136

**American Lock & Supply, Inc.**

4411 E. LaPalma Ave.

Anaheim, CA 92807

(714) 996-8882,

(800) 854-8775, (Out of State)

FAX: (714) 579-3375

Key Personnel: Sean DeForrest, Pres.;

Bill Power, VP-Sales; Rick Myers, Dir-

Mktg.

Nine locations throughout U.S. \$20 million plus inventory. All major lock lines. "Value-added services" designed



**HPC, Inc.**  
**Designing Excellence and**  
**Manufacturing Quality since 1956**

[Click here for more information](#)



**LOCKMASTERS**  
**SECURITY**  
**MANAGEMENT**

TM

**Providing quality tools,**  
**parts, and service for the**  
**security professional.**

[Click here for more information](#)



**LOCKMASTERS**  
**SECURITY**  
**MANAGEMENT**

TM

to help its customers build their businesses.

**Amos Lock & Key Supply Co.**  
2711 Cullen St.  
Fort Worth, TX 76107  
(817) 429-9441, (817) 335-5397,  
(800) 772-7432  
FAX: (817) 335-5399  
Key Personnel: Amos Strange, Pres.

**Anderson Lock Co., Ltd.**  
1801 Oakton St.  
Des Plaines, IL 60018  
(708) 296-1157  
FAX: (708) 296-9259  
Key Personnel: Eugene R. Anderson,  
Pres., CPP; Norman A. Anderson, GM

**Andrew's Wholesale Lock Supply**  
921 Chestnut St.  
Lebanon, PA 17042  
(800) 544-0519, (717) 274-8733  
FAX: (717) 274-8659  
Key Personnel: Richard A. Rudy,  
(Andy) Owner  
A full line distributor of Briggs &  
Stratton and Auto Security products.  
Save 10-20% each order, a 2% discount  
on MasterCard/Visa orders, no C.O.D.  
charges, and a minimal  
shipping/freight charge.

**Anes Security, Inc.**  
2825 Warner Ave.  
Irvine, CA 92714  
(714) 559-9126  
(800) 275-2637

Key Personnel: Jay Smith, Exec. VP  
Complete vehicle security supplier.  
Remote controlled alarms, steering  
wheel locks, hood and trunk locks.

**Apex Security Hardware Corp.**  
1201 36th Street  
Brooklyn, NY 11218  
(718) 438-2115 (NY),  
(800) 232-1117 (Nat'l)  
FAX: (718) 438-3327  
Key Personnel: Eli Guth, Pres.  
Apex Security, a distributor of most  
major lock lines since 1976, offers same  
day shipment at competitive prices.  
Some of the lines stocked by Apex  
include Arrow, Medeco, Kwikset,  
Folger Adam, Simplex, Detex, Master,  
Adams Rite, Securitron, Ilco, Marks,  
American, Norton, All Lock, ASP,  
Precision Hardware, and Amsec Safes.

**Aristo Sales Co., Inc.**  
27-24 Jackson Ave.  
Long Island City, NY 11101  
(718) 361-1040, (800) 221-1322  
FAX: (718) 937-5794  
Key Personnel: Roslyn Rosenblatt,  
Pres.; Leonard Rosenblatt, VP; Joe  
Lewanduski, Mgr.  
Specializing in automotive security  
locks and alarms, locksmith supplies  
for over 50 years. Full stocking  
distributor in Briggs & Stratton, All-  
Lock, Auto Security Products, Arrow,  
Segal, American, Master, Detex, HPC,  
Star Key Blanks, Ambassador Safes,  
Ilco, Medeco and Fichet, and other

specialty items. Service is our business.

**Arius**  
959 Concord St.  
Framingham, MA 01701  
(800) 432-3232  
FAX: (508) 872-3528  
Arius distribution centers in more than  
60 cities supply dealers and installers  
with burglar and fire alarm, CCTV,  
access control and other security  
products. We provide a large selection,  
technical assistance, quick availability  
and competitive pricing.

**Armstrong's Lock & Supply, Inc.**  
1440 Dutch Valley Place, NE  
Atlanta, GA 30324  
(An LSDA Company)  
(404) 875-0136, (800) 726-3332 (Atlanta,  
GA)  
(305) 651-1598, (800) 827-3332  
(Miami, FL),  
(813) 886-8007, (800) 829-3332  
(Tampa, FL)  
Key Personnel: D. Virl Mullins, Pres.;  
Sam Cox, Gen. Sales Mgr.  
Full line distributors of locksmith  
supplies, electrical devices, safes,  
automotive, locks and various other  
security products. Miami branch: 1766  
N.E., 205th Terrace, No. Miami Beach,  
FL 33179. Tampa branch: 5507 Pioneer  
Park Blvd., Bldg. B, Tampa, FL 33614.

**Associated Lock & Supply**  
2552 Barnet Hwy.  
Port Moody, BC V3H 1W3

*Continued on page 88*

**Major**  
MANUFACTURING, INC.

[Click here for more information](#)

*Every Installation  
Is a Self-Portrait of the  
Person Who Did It.  
Autograph Your Work  
with Excellence.*

**medeco**<sup>®</sup>  
HIGH SECURITY LOCKS

[Click here for more information](#)

*Integrity.  
Ingenuity....  
security solutions.*



Associated Lock & Supply

Continued from page 87

(604) 461-1622, (800) 663-1231  
FAX: (604) 461-3129

**Autotech Accessories, Inc.**

150-77th Street  
Brooklyn, NY 11209  
(718) 680-8901  
FAX: (718) 833-0695

Key Personnel: Jerry Petrino, Pres.;  
Edward Schwartz, VP-Sales/Mktg.;  
Anita Knutsen, Office Mgr.  
Distributor of automotive anti-theft  
systems and other automotive items.  
Exclusive USA distributor of Lasso  
Lock and C-Block Cassette Lock for the  
prevention of car radio theft.

**B.B.W. Distributors Inc.**

270 Jackson Ave.  
Bronx, NY 10454  
(212) 993-4322, (800) 252-7766  
FAX: (212) 402-4918

Key Personnel: Robert Reiss, Pres.;  
Issac Stern, VP/GM  
Same day shipment, vertical horizontal  
and pedestal, mailboxes, locks and  
parts. Up to 10" face plate mortise  
locks, Norton closers, precision,  
kickplates, push and pull plates, door  
stops and holders. Up to 7" spring  
hinge in stock, chimes, concept, Detex  
removable core, electric strikes, drill  
lock, Markar, American, Master,  
Arrow, Don-Jo keyblanks, drill bits.

**Barry Supply Co.**

Division of Barry Industries, Inc.  
36 West 17th St.  
New York, NY 10011  
(212) 242-5200

Key Personnel: B. Wein, Sales; W.  
Wein, Purch.  
Barry Supply Co. has been in business  
over 25 years. The company specializes  
in the manufacture and distribution of  
window and door hardware for  
replacement. Customer base is world  
wide. Samples are required for correct  
matching.

**Baxter Locksmith Supply**

1934-D John Towers Ave.  
El Cajon, CA 92020  
(800) 962-7319

Key Personnel: Mike Lancaster,  
Owner; Nadine McGahney, Warehouse  
Mgr.; Sheila Cox, Office Mgr.  
Wholesaler of tryout keys, guide keys,  
code books, key blanks, continental  
micro cards, auto security foreign car  
locks, picks, mortise locks and  
cylinders, rim locks, padlocks, key  
machines, car opening tools, pins and  
pinning kits, domestic auto locks, cam  
locks, key rings, hide-a-keys, Grobet  
files, misc. locksmith tools.

**Baylis Wholesale**

7 Pamoron Way  
Novato, CA 94949  
(800) 227-0503 (Nat'l)  
(415) 883-0550  
FAX: (415) 883-5704

Key Personnel: Buzz Baylis, Pres.  
A large distributor of automotive locks  
and keys in the country with more than  
2000 foreign and domestic part  
numbers in stock. Featured is a  
complete line of Briggs & Stratton and

auto security products locks and parts,  
along with rubber headed key blanks  
to fit most foreign and domestic cars.

**Bell's Security Sales, Inc.**

411 Bloomfield Ave.  
Bloomfield, NJ 07003-4832  
(800) 772-2266  
FAX: (201) 743-6357

**Berg Wholesale Inc.**

West Coast Warehouse  
P.O. Box 29169  
Portland, OR 97229  
(800) 243-8887  
FAX: (800) 343-0937

Key Personnel: Ken Pederson; Kent  
Hammond; John Dersch, Nat'l Service  
Reps.

East Coast Warehouse  
374 Explorer's Cove  
Altamonte Springs, FL 32701  
(800) 582-8107  
FAX: (407) 332-4855

Key Personnel: John Blough, Gen.  
Mgr.; Steve Dean, Outside Sales Rep.  
Same day shipment. Kwikset, Russwin,  
Corbin. Discount pricing. Cylindrical  
mortise, lever x lever locks, closers,  
panic devices, deadbolts, cylinders,  
keyblanks, and special keyways.  
Masterkeying and construction keying  
done quickly. Miscellaneous door  
hardware, decorative hardware.

**BISM, Inc.**

20529 Old Cutler Rd.  
Miami, FL 33189  
(305) 251-0295  
FAX: (305) 251-0035

Key Personnel: Irene Wickward, Pres.;  
Bill Wickward, VP  
Importers of SEYMA high security  
equipment of Costa Rica. Seyma  
manufactures safes for home and office  
use, with two hours fire rated. They  
also manufacture UL high security  
safes TL30 through TRTL30x6 and a  
hotel safe which you open with your  
personal credit card. BISM also  
represents National Security Safe Co.  
in Utah.

**Blaydes Lock Co. Inc.**

2335 18th St., N.E.  
Washington, D.C. 20018  
(202) 832-7100, (800) 424-2650  
FAX: (202) 832-1359

Key Personnel: Edward J. Hildebrand,  
Pres.; Tom Rakes, VP; Bob Chanin,  
Sales Mgr.  
Mid-Atlantic area's professional  
security hardware supplier since 1954.

**Blue Dog Keys**

P.O. Box 195429  
Winter Springs, FL 32719-5429  
(407) 695-1311

Key Personnel: Liam Gribben  
The single most reliable source of  
keyblanks in the world. Its all we do  
and we do it very, very well. Bit, barrel,  
safe deposit, luggage, furniture, flat  
steel. Foreign and domestic.  
Commercial and residential. Retail  
locksmiths only please. We do not sell  
to end users. Never have...never will.

**Brady Office Machine Security**

11056 S. Bell Ave.  
Chicago, IL 60643  
(312) 779-8340 (312) 779-9712

Key Personnel: Bernadette Brady, Pres.;  
Don Brady, VP  
Universal security devices designed to  
prevent theft of computer equipment  
and peripherals, all office equipment,  
fax machines, microwaves, TVs, VCRs  
and similar equipment. We also have  
power switch and floppy drive locks,  
electronic keyboard lockouts, and data  
protection.

**BOSTON LOCK & SAFE CO., INC.**

30 Lincoln St.  
Boston, MA 02135  
(617) 787-3400, (800) 252-5757  
FAX: (617) 787-3425

Key Personnel: Harry J. Stoia, Pres.;  
James C. Condil, VP; J. Norbert  
Bartholomew, VP

We stock for immediate shipment one  
of the largest selections of Falcon,  
Baldwin, and Medeco locks. We also  
stock the largest selection of S & C safe  
locks, ISM, Amsec, Steelage and New  
England safes for immediate shipment.  
Our service department maintains  
parts availability for domestic and  
foreign made high-security safes.

See ad on page 70

**BOYLE & CHASE, INC.**

72 Sharp St.  
Hingham, MA 02043  
(800) 462-6240 (MA),  
(800) 325-2530 (Nat'l)  
FAX: (617) 335-5342  
See ads on pages 67, 69, 71, 73, 75, 77

**C&M Tool**

4418 Eggers Dr.  
Fremont, CA 94536  
(510) 792-6613  
Key Personnel: Carl Mantini  
Manufacturer and distributor of the  
sliding patio door fastener.

**Canada Lock Products**

(An LSDA Company)  
70 Floral Pkwy.  
Toronto, Ont. M6L 2C1  
(416) 248-LOCK (5625)  
(416) 248-6268  
(800) 268-1306 (Ontario)  
(800) 387-7755 (Canada only)  
FAX: (416) 248-9945

Key Personnel: Jack Laufer, Pres.;  
Steve Dyson, GM; Steve Wittenberg,  
Sales Mgr.  
Wholesale distributor for major  
security hardware manufactures for  
over 50 years. Specializing in safes,  
access control, electrical hardware, exit  
devices, auto locks, high security  
hardware, key blanks, door closers,  
locksmith tools and supplies and door  
hardware. Offering prompt service  
throughout Canada.

**Capitol Lock & Hardware Co., Inc.**

3730 Georgia Ave., NW  
Washington, DC 20010  
(202) 882-9502  
Key Personnel: W. Schlegel, Pres.; B.  
Dillon, Mgr.; M. Bernard, Sales  
Full line distributor of locks, keys, key  
machines, high security padlocks,



**Capitol Lock & Hardware Co. Inc.**

*Continued from page 88*

combination locks, electronic access controls. One of the largest stocks of locks and key blanks on the East Coast. Ship most orders from stock. Specialize in high security devices of all kinds. Ship worldwide; gives us a call.

**Central Lock & Hardware Supply Co.**  
95 NW 166th St.  
Miami, FL 33169  
(305) 947-4853  
FAX: (305) 949-8945  
Key Personnel: Betty Ross, Svc.

**City Intercoms, Inc.**  
16356 Alexander Run  
Jupiter, FL 33478-8282  
(800) 248-9468  
FAX: (407) 743-4456  
Key Personnel: Eliot S. Sashe, VP  
Stocking Distributors for: Airphone Intercom Systems, Marlee Electronic (Entraguard), TekTone Sound & Signal (Intercom Products), West Penn Wire.

**Clark Security Products**  
7140 Engineer Rd.  
San Diego, CA 92111  
(619) 565-7140 (San Diego, CA);  
(303) 375-9200 (Denver, CO);  
(602) 275-4431 (Phoenix, AZ);  
(916) 372-6630 (Sacramento, CA);  
(206) 467-3000 (Seattle, WA)  
Key Personnel: Marshall Merrifield, Pres.

Clark Security is a wholesale distributor of door hardware and locksmith supplies. Clark stocks over 25,000 items from more than 250 manufacturers. Clark guarantees 100% same day shipment of all orders called in by 5 p.m. and call backs on all shorts.

**Colonial Lock Supply Co., Inc.**  
7000-G Newington Rd.  
P.O. Box 1417  
Newington, VA 22122  
(703) 550-077 (800) 732-9117  
FAX: (703) 550-8857  
Key Personnel: Gary Baldino, GM; Don Dassing, Sales.  
Supplying: Ilco, Yale, Rutherford Controls, Amsec, American Padlock, ASSA, Falcon, Arrow, DOM and much more.

**Commonwealth Lock Co.**  
1853 Mass. Ave.  
Cambridge, MA 02140  
(617) 876-3301  
FAX: (617) 661-3168  
Key Personnel: Edward A. Mayer, Pres./Treas.  
We specialize in lock hardware.

**Cook's Supply Inc.**  
(An LSDA Company)  
4770 Fox St., Unit 13  
Denver, CO 80216  
(303) 294-0567 (Local)  
(800) 445-4008 (Rocky Mtn, Plain States)  
FAX: (303) 292-4569  
Key Personnel: Jack Dunn, GM; Denise Higney, Office Mgr.  
Distributor of locksmith supplies and equipment, as well as various other security products. Same day shipping

with great personalized service and competitive pricing. Our motto "No job too big, no locksmith too small." We know that satisfaction and service are important to you. Let's continue growing together. We thank you.

**CooperTools**  
P.O. Box 728  
Apex, NC 27502-728  
(919) 362-7510  
CooperTools is dedicated to providing a comprehensive line of quality tools and equipment for the professional, industrial, electronic, hobby, notions, sporting and do-it-yourself markets throughout the world.

**Craftmaster Hardware Co. Inc.**  
176 Kansas St.  
Hackensack, NJ 07601  
(800) 221-3212, (201) 646-9355  
FAX: (201) 646-0181  
Key Personnel: Michael Spingeld, Pres.; Anthony Cani, VP Sales.  
Stocking distributor of Arrow, HPC, Ilco, Kwikset, Schlage, Star and most major lines. Specializing in all types of key blanks for over 35 years. Offering the level of service only available from a third generation family owned business.

**CUSTOM SECURITY PRODUCTS**  
P.O. Box 3016  
Simi Valley, CA 93093  
(805) 522-5580  
FAX: (805) 522-3591  
Key Personnel: Donald Hughes, John La Mel  
Manufacturers of Pickmasters tubular lock pick and other tubular lock related products. Also we are a wholesale distributor of other manufacturers products that are tool related: key machines, key blanks, and other types of security products.  
**See ad on page 115**

**D&H Distributing Co.**  
2525 N. 7th St.  
Harrisburg, PA 17110  
(800) 877-1200  
FAX: (717) 255-7838  
Key Personnel: Douglas Byrne, Div. Mgr.  
Over 70 years of distribution experience. Nine locations serving the entire U.S.A. Full stocking distributor of over 30 major brands of security, fire, CCTV, intercoms access control, and magnetic locking devices.

**Diebold, Inc.**  
3320 Gilchrist Rd.  
Mogadore, OH 44260  
(216) 798-5625  
Key Personnel: John Boyajian, Dir.  
Trade names-Banklock.

**DIMARK INTERNATIONAL**  
3233 Skyway Dr.  
Corporate Hangar 3D  
Santa Maria, CA 93455  
(800) 235-2435, (800) 736-1525 (CA)  
FAX: (805) 928-8034  
Key Personnel: Mark Pirman/Diane Pirman

Factory representatives for Borkey key machines and blanks, as well as other European manufacturers. Security boxes, key control, tools and assorted locksmith needs.  
**See ad on page 105**

**Direct Safety Co.**  
7815 South 46th St.  
Phoenix, AZ 85044  
(602) 978-7009, (800) 528-7405  
FAX: (800) 366-9662  
Key Personnel: Patrick Acton, Mktg. Mgr.; Tom Reine, Product Mgr.  
Direct Safety Company is a national catalog distributor of safety equipment to business and industry. Catalogs feature alarms, barricades, communication equipment, lighting, mirrors, signs and more.

**Dixie Lock Supply, Inc.**  
2025 NW 167th St.  
Miami, FL 33056  
(305) 625-5525, (800) 447-6616  
FAX: (305) 623-9564  
Key Personnel: Syd Friedman, Pres.; Fred Cohen, VP; R. Friedman, Secy./Treas.  
Wholesale distributors of major American lines: key blanks, locks, locksmith supplies, door hardware, safes, and electronic security. Warehouse has been expanded by 18,00 feet.

**Doormark Inc.**  
2519 South Blvd.  
Houston, TX 77098  
(713) 526-8780  
FAX: (713) 526-9270  
Key Personnel: Peter T. Serebrenik, Pres.; Barbara Kretschmar, Off. Mgr.  
Doormark, Inc. is the North American distributor for Wilhelm Grundmann Rohrbach. This 100 year old Austrian firm specializes in door locks, fittings and hardware. The hardware is available in a variety of designs and finishes and trims both interior and exterior applications including their vault-like security locks.

**Doyle Lock Supply, Inc.**  
2211 West River Road North  
Minneapolis, MN 55411  
(612) 521-6226  
(800) 33-DOYLE, (800) 333-6953  
FAX: (612) 521-0166  
Key Personnel: Robert Hromadko, Pres.; Paul Justen, GM; John Walter, Purchasing Mgr.  
Weiser, Schlage, Master, Amsec, Major, LCN, Norton, Gardall, S & G, Rofu, Simplex, Medeco, Locknetics, Yale and ASSA. Complete line of original key blanks as well as Ilco .140 other manufacturers products in stock. A complete line of private label products including the safes. Our 70th year in business.

**DRK Specialties**  
5423 Central Ave., Ste. 7  
Newark, CA 94560  
(510) 790-2619  
FAX: (510) 790-2238  
Key Personnel: Don R. Kuhn, Owner/Pres.



**DRK Specialties**

*Continued from page 98*

DRK Specialties is the complete key accessory source for locksmiths seeking the latest key rings and innovations. Current best sellers are the versatile sur loc key ring assortment, hide-a-rocks, squeeze lites and auto logo key rings. Distributor for Lucky Line, Peebee, ESP, Wet Winds, Calif. Safe Cans and others.

**Dugmore & Duncan, Inc.**  
30 Pond Park Rd.  
Hingham, MA 02043  
(800) 225-1595  
FAX: (617) 740-4043  
Key Personnel: Tom Fuery, Mgr.  
322 Reynolds Rd.  
Lakeland, FL 33803  
Contact: Gene Lavoie  
9251 Orco Pkwy.  
Riverside, CA 92509  
(800) 325-1595  
FAX: (714) 360-0572

Contact: Charles (Skip) Reid  
Sargent Lock full line stocking distributor. Extensive inventory. For immediate delivery. No minimum order required. Also stocking Don-Jo Mfg. full line.

**C.H. Edwards, Inc.**  
P.O. Box 775  
Hwy. 11 South  
Greenville, NC 27834  
(800) 334-3642 (USA)  
(919) 756-8500 (NC)  
All stock items shipped within 24 hours after order is placed. Inquire

about current sale items.

**ELECTRIC LOCK SUPPLY**  
617 So. Hindry Ave.  
Inglewood, CA 90301  
(800) 858-1726  
FAX: (213) 568-1507  
Key Personnel: Kenneth Strait, Pres.; Brian Gordon, Sales Mgr.; Dave Hutchison, Sales/Tech Support  
Wholesale distribution consultation to the access control trade. Stocking: Adams Rite, Alarm Controls, Edwards, Folger Adam, F-Systems, GRI, Linear, Microwave Sensors, Microstate Electronics, Modern Electronics, Monthard, Securitron, Security Door Controls, PowerSonic, Rofu, Trine, Alarm Lock, Stanley, Transcience, KeeCo., MooreOmatic, Essex, Marlok, Select, Oregon Scientific, Optex, Locknetics, International, Doraado, and Altronix.

**See ad on page 56**

**ELJAY EXPRESS**  
P.O. Box 1388  
Wheeling, IL 60090  
(708) 480-1311, (800) 432-1311  
Large stocking distributor for Arrow locksets. We can satisfy all your needs for Arrow.

**See ad on page 116**

**Empire Security Supplies**  
4600 B Nesconset Hwy.  
Port Jefferson Station, NY 11776  
(516) 928-1919

FAX: (516) 928-4745  
Key Personnel: Ira Levine, Pres.; Bob Gorman, Sales Mgr.  
Empire Security Supplies is a young and rapidly growing distributor of locksmith and hardware supplies. We have been in business for seven years, and are constantly expanding our line of manufacturers' products. We are one of the largest wholesale distributors on Long Island, New York. We believe in personalized service and quality merchandise.

**Enixus Trade Ltd.**  
34 Dunkirk Rd.  
St. Catharines, Ont. Canada L2R 1A1  
(416) 682-3086  
FAX: (416) 682-4744  
Key Personnel: George Papaiz, Bruno Papiz, Directors  
Enixus Trade Ltd., incorporated in 1986, is a growing St. Catharines based company situated within one day's trucking to 56% of the north American manufacturing market. The company stocks and extensively distributes Enixus solid brass padlocks and furniture locks. It enjoys a reputation for quality and fast service throughout the industry.

**Ewert Wholesale Hardware Inc.**  
4709 W. 120th St.  
Alsip, IL 60658  
(800) 345-6562, (708) 597-0059  
FAX: (708) 597-0881  
Key Personnel: Brian King, Sales; Wes

*Continued on page 98*

**NATIONAL**  
AUTO LOCK SERVICE, INC.

**National Auto Lock Service, Inc. offers a wide range of equipment and services for the Automotive Locksmith. From tools and hard to find key blanks to transponder programming, we can take the mystery out of car service. We accept credit card orders, and can ship COD. Contact us for the latest in automotive technology.**

[www.laserkey.com](http://www.laserkey.com)



**Choose S&G  
Comptronic electronic  
safe locks for...security...  
technology...tradition.**

[Click here for more information](#)

Ewert Wholesale Hardware Inc.

Continued from page 92

McKenney, Sales; Clelia King, Acct. Rec  
Ewert Hardware has added the Russwin line to our inventory. We will be supporting both Corbin and Russwin for the locksmith industry.

**Express Hardware**  
1203 S. Northwest Hwy.  
Barrington, IL 60010  
(800) 323-7447  
FAX: (708) 381-7199

Key Personnel: Steve Yellin, Pres.  
Express Hardware is a full line supplier of Schlage, Von Duprin, Baldwin, Norton and Hager products.

**Fairway Supply Inc.**  
4303 Dacoma  
Houston, TX 77092  
(713) 957-2160  
WATS: (800) 767-FAIR  
FAX: (713) 957-2122

Key Personnel: Don Bradford, Pres.; Bob Conley, VP; Rick Gummelt, VP

**FASTRACK HARDWARE, INC.**  
3655 North 126th St.  
Brookfield, WI 53005  
(800) 458-8707

FAX: (414) 781-4232  
Key Personnel: Paul Federspiel, Cust. Svc.  
Full line distributor of Yale products. Yale locks, keyblanks and cylinder plugs in stock for immediate shipment. If you need Yale fast, get on the right track with Fastrack Hardware, Inc.

See ad on page 118

**Fichet-North America**  
1255-A Oakbrook Drive  
Norcross, GA 30093  
(404) 448-5593  
FAX: (404) 263-6567  
Key Personnel: Cathy Hays, Oper. Mgr.; Philippe Rimbart, Pres.  
Manufacturers and distributors of high security safes, fire and record safes, deposit safes, vault doors, safe deposit boxes and in-room safes.

**Foley Belsaw Co.**  
**Locksmith Division**  
6301 Equitable Rd.  
Kansas City, MO 64120  
(800) 821-3452 (orders only)  
(816) 483-2700 (cust. svc.)

**Fortress Safe & Lock**  
336 Northland Blvd.  
Cincinnati, OH 45246  
(513) 772-4392, (800) 562-0295

**Fradon Lock Co., Inc.**  
467 Burnet Ave.  
Syracuse, NY 13203  
(315) 472-6989, (800) 447-0591 (E)  
Key Personnel: Don Rapp, Pres.; Frank Sweet, VP; Hope Bolinger, Safe Sales  
Safe lock and key distributors. Safes: Amsec, Gardall, Knight, Major, Meilink, Mosler, Sentry. Safe Locks & Parts: Precision Products, others. Auto-Locks: Briggs & Stratton "Full Line," Auto Security Products "Full Line," Key Blanks: ESP "Full Line."

Fried Bros. Inc.

467 N. 7th St.  
Philadelphia, PA 19123  
(800) 523-2924 (Nat'l.)  
(800) 356-5050 (PA)  
Key Personnel: Alex Ebrahimzadeh, Pres.  
Fried Bros. Inc. was established in 1922 in Philadelphia. Presently we supply the locksmiths from two warehouses located in Philadelphia and Phoenix, Arizona. We stock locks, padlocks, key machines, door closers, exit devices, decorative hardware, safes, vault, mail boxes and intercoms.

**Fulton Lock Co.**  
**Div. Cleidotech Systems Ltd.**  
88 Fulton St.  
New York, NY 10038  
(212) 732-1314  
FAX: (212) 962-0232  
Products: Quality key machines and key blanks.

**G-U HARDWARE, INC.**  
11761 Rock landing Dr. (M-6)  
Newport News, VA 23606  
(804) 873-1097  
FAX: (804) 873-1298  
Key Personnel: Keven McDaniel, VP; Gerhard Loeffel, VP  
Specialists in multiple lock door hardware.

See ad on page 107

**Grace's Wholesale & Supply Div.**  
214 East 2 St.  
Hastings, NE 68901-5217

Continued on page 100



**STRATTEC™**

**The world's  
largest  
producer of  
automotive  
locks and keys.**

[Click here for more information](#)

**SRi**  
**SECURITY**  
**RESOURCES INC.**

**SRi and Tech Train  
Productions are the  
automotive specialists -  
your best source for  
automotive tools,  
manuals, and videos.**

[Click here for more information](#)



Graces Wholesale & Supply Division

*Continued from page 98*

(402) 462-2737 (1-9 p.m. CT)

Key Personnel: H. Roger Grace, Prop.  
CCL Security Products, Circle-Ess key machines, Ileo Lock Co. products, LAB pins and kits, locks, parts, key blanks and tools stocked. Also, new and resharpened cutters. Resharpened cutters on exchange basis or outright sale.

**R.A. Graham Co., Inc.**

70 James St.  
Worcester, MA 01603  
(508) 755-5815, (800) 333-3933  
FAX: (508) 755-6584

R.A. Graham Co. is a full stocking distributor of Brassworks by KABA solid brass designer door hardware. They also stock Schlage, Kwikset, Weiser, Dexter, Ives, Master, Monarch, Norton, Stanley, Don-Jo, Gainsborough, along with many other manufacturers.

**Grandview Hardware Co.**

525 W. Seneca St.  
Ithaca, NY 14850  
(607) 273-0526

Distributors of Baldwin mortise locks and decorative hardware.

**Great Lakes Lock Distributors**

2301 Sassafras St.  
Erie, PA 16502  
(814) 459-0546, (Local)  
(800) 543-8837  
FAX: (814) 456-1542

Key Personnel: John Carneval, Owner;  
John Carneval, Jr., GM; Greg Mello,  
Sales

We represent over 30 manufacturers including: Abus, Detex, ESP, LCN, Lori, Master, Medeco, Monarch and Precision. Our Medeco inventory includes commercial as well as biaxial keyways. We can provide masterkey systems cut keys and keying. We accept Visa and Mastercard and our minimum order is only \$10.00.

**H. Hoffman Co.**

7330 W. Montrose Ave.  
Chicago, IL 60634  
(An LSDA Company)  
(708) 456-9600 (Local)  
(800) 942-0217 (Illinois)  
(800) 323-1918 (Midwest)  
H. Hoffman Co. Distribution Centers:  
(800) 382-9449 (Indianapolis, IN),  
(800) 392-1303 (St. Louis, MO),  
(800) 472-9191 (Milwaukee, WI),  
(800) 247-8217 (Cleveland, OH),  
(800) 526-5897 (Kansas City, KS)  
FAX: (708) 456-0878

Key Personnel: Al Hoffman, Pres.;  
John Bosworth, Sales Mgr.; Karen  
Hoffman Kahl, Mkt. Mgr.  
H. Hoffman, the "House of Locks" has over 50 years experience as a distributor of a full line of security hardware and related products, i.e. locksmith supplies, safes, electronic controls, novelty items, etc., enjoying a reputation built on quality services. Same day delivery, selling catalog, monthly flyers, competitively priced serving mid-America.

**H.S. & S. Wholesale Distributor of  
Lock Hardware**

12915 W. 8 Mile  
Detroit, MI 48235  
(800) 521-2202, (800) 482-3000 (MI)  
FAX: (313) 342-7580  
Key Personnel: Michael Solomon,  
Pres.; Neil Cronk, Sales Mgr.

**Hardware Agencies Ltd.**

1220 Dundas St. East  
Toronto, Ontario Canada M4M 1S3  
(416) 462-1919, (800) 268-6741  
Key Personnel: James Roberts, Mktg.  
Mgr.; Paul Halberstadt, Pres.  
Full line locksmith supplier. Lock and door hardware, key blanks, key machines, locksmith tools and equipment, high security lock lines, padlocks.

**Hardware Sales & Supply**

35950 Industrial Rd.  
Livonia, MI 48150  
(An LSDA Company)  
(313) 591-1150, (800) 521-0955  
(Midwest)  
(800) 837-5625 (PA)  
FAX: (313) 591-7289

Key Personnel: Milt Goldman, Pres.;  
Arnie Goldman, Op. Mgr.; Ed Mooney,  
Branch Mgr.  
Hardware Sales & Supply Co. is a full-line stocking distributor of locksmith supplies since 1925. Hardware Sales has begun the 1990's with the introduction of its first branch in Pittsburgh, Pennsylvania, and the publication of its outstanding 1990/91 security hardware catalog.

*Continued on page 104*



**SCHWAB CORP.**

*Fire protection for your vital records.*

**Free freight!!**

**No middle  
man!!**

[Click here for more information](#)



**ASP Covers the World  
of Auto Locks**

[Click here for more information](#)



Continued from page 100

**Hardware Specialties, Inc.**  
R.D. 2, Box 28A  
Dubois, PA 15801  
(814) 371-8694  
FAX: (814) 371-0590

**Hardware Suppliers of America, Inc.**

213 Mill St.  
Winterville, NC 28590  
(800) 334-5625 (NC),  
(800) 334-5625 (TX),  
(800) 282-8499 (FL),  
(800) 358-6016 (GA),  
(800) 334-5625 (OH)  
(800) 334-5625 (CA)  
FAX: (800) 334-5635

Key Personnel: Francis Casey, Pres.;  
Linwood Thomas, Nat'l. Sales Mgr.  
Schlage locks, parts and accessories;  
Dexter locks and parts; Baldwin  
products; H.B. Ives products; Monarch  
panic devices; Norton Closers; Rixson-  
Firemark products; Simplex push-  
button locks; Major Metalfab key  
cabinets; Hager and McKinney hinges;  
Rytan key cutters; and Falcon locks  
and parts.

**Hazelton Key Mfg. Co.**

34 Carlisle Rd.  
Westford, MA 01886  
(800) FOR -KEYS

Key Personnel: Chris Franklin, owner  
We specialize in personalized key  
blanks factory embossed. We have our  
own line of brass keys and are also a  
distributor of keys and locks for both  
ESP and Ilco. We can personalize  
almost any key both foreign and  
domestic.

**Heat Pack U.S.A.**

2208 #3 NW Birdsdale  
Gresham, OR 97030  
(800) 468-5945

FAX: (503) 665-5373  
Key Personnel: Chris Lindsay, Pres.;  
Steve Casey, VP  
New technology reusable lock deicer  
and reusable hand warmer.

**Helen's Keys & Locks**

1145 St. Jude Dr.  
Schnectady, NY 12303  
(518) 355-7000

Key Personnel: Helen K. Frier  
Locksmith supplies, wholesale only.  
We carry business and technical aids,  
locking devices, locksmithing industry  
supplies and equipment. A 104 page  
catalog is available. The business  
started in 1972.

**Independent Hardware Inc.**

14 S. Front St.  
Philadelphia, PA 19106  
(215) 925-5306, (800) 346-9464  
FAX: (215) 922-6552

Key Personnel: Frank Stanco, Pres.;  
Vincent Campagna, VP  
Stocking wholesale distributor of  
Schlage, Kwikset, Dexter, Corbin,  
Norton, Master, Yale, Von Duprin,  
Adams Rite, Arrow, Ilco, National,  
Folger Adam, Sargent, Simplex,  
Chicago, Dorma, Bommer, Alarm Lock,  
Lab, Lori, Rixson, Quincy, Seidle,  
Russwin, Locknetics hinges. Centrally

located in Philadelphia. We offer same  
day shipping.

**Instant Hardware Delivery**

12321-B Wilkins Ave.  
Rockville, MD 20852  
(800) 437-5837 (Nat'l),  
(800) 492-6805 (MD),  
(301) 231-5020  
FAX: (301) 279-7913

Key Personnel: Beverly Vigue, VP;  
Jayme Wilburn, Sales Rep.; Kenneth  
Domurot, Sales  
I.H.D. is an established wholesale  
distributor center located in Rockville,  
MD supplying exclusively to contract  
houses, suppliers and locksmiths. We  
represent three manufactured lines of  
commercial/residential hardware,  
namely Schalge, Von Duprin and Valli  
and Colombo.

**Intermountain Lock & Supply**

3106 S. Main  
P.O. Box 65158  
Salt Lake City, UT 84115  
(801) 486-0079, (UT),  
(800) 453-5386 (US)  
FAX: (801) 485-7205

Key Personnel: Jay Hickenlooper,  
Pres.; Bob Steinman, Mgr.

**Island Pacific Distributors, Inc.**

1668 King St.  
P.O. Box 22189  
Honolulu, HI 96822  
(808) 955-1126  
FAX: (808) 946-6480

Key Personnel: Leon Wolfley, Pres.;  
Barbara Wolfley, VP  
Founded in 1978, full line distributor of  
locksmith supplies and builders  
hardware. Also, large designer  
hardware and bath fixtures.

**JLM Wholesale, Inc.**

3204 Adventure Lane  
Oxford, MI 48371  
(800) 522-2940  
FAX: (800) 782-1160

Key Personnel: Ray Baldwin, GM;  
Kenn Andridge, Sales Eng.; Jan Mirku,  
Pres.  
We have in stock for immediate  
delivery Folger Adams, LCN Closers,  
Locknetics Security Engineering, Roton  
Hinges, Von Duprin, Adams Rite and  
Glynn Johnson products. Help with  
application is available from our  
consultants. Most orders are shipped  
same day as received.

**Hans Johnsen Co.**

8901 Chancellor Row  
Dallas, TX 75247  
(800) 678-1560, (214) 879-1500  
FAX: (214) 879-1530

Key Personnel: Howard H. Johnsen,  
Pres.; Saul Espinoza, VP-Lock; Edward  
Ibarra, Mktg.

**A.T. Jones & Son**

1456 Broadway  
Detroit, MI 48226  
(313) 965-1455  
FAX: (313) 965-1093

Key Personnel: Bob Volgoi, Johnn  
Dunn, Rick Sowinski  
A.T. Jones & Son serving the locksmith

since 1904. Representing Adams-Rite,  
Arrow, Baldwin, Chicago, Corbin  
Cabinet, P&F Corbin, Detex, Dexter,  
Don Jo, Folger Adam, Glynn Johnson,  
Hager, HPC, Ilco, Illinois, LCN, Master,  
Medeco, National Lock, National  
Guard, Rixson, Rofu, Sargent, Schlage.

**Jo-Van Distributors**

929 Warden Ave.  
Scarborough, Ontario  
Canada M1R 4C6  
(416) 752-7210, (800) 268-5731  
FAX: (416) 752-3845

Key Personnel: Leonard J. Passarello,  
CPL., Pres.  
Your one-stop distributor. Fast, reliable  
service. USCAN distributor.

**K-D-L Hardware Supply Inc.**

1621 8th Ave.  
Seattle, WA 98101  
(206) 682-7383

KDL Hardware Supply Inc. has been in  
the security hardware business since  
1919. We distribute products from over  
200 manufacturers. In 1985, we joined  
the "USCAN" distribution network  
which provides the opportunity to  
purchase at most competitive pricing.  
Competitive pricing and great service  
have been KDL trade marks.

**KENCO SUPPLY CO.**

2531 North 85th St.  
Omaha, NE 68134  
(800) 228-2266, (402) 397-8291

Key Personnel: Charles Kent, Pres.;  
Robert Kent, VP; Steve Thilliander,  
Warehouse Mgr.  
At Kenco, we offer a free catalog just a  
phone call away. We also have no  
minimum order and we are a full line  
distributor offering 12,000 different  
items. At Kenco your satisfaction is our  
most important goal. Kenco, where we  
haven't forgotten that service is  
important.

See ad on page 46

**Kenton Locksmith Supplies, Inc.**

10 Lincoln Street  
Kansas City, KS 66103  
(800), 888-LOCK, (913) 432-2739  
Distributor for most major  
manufacturers.

**THE KEY CONNECTION**

1932 NE 151st Street  
North Miami, FL 33162  
(305) 940-7720, (800) 798-5625  
FAX: (305) 947-6889

Key Personnel: Mike Penso, Pres.  
See ad on page 57

**Key Mart Inc.**

3171 S.E. Dominica Terr.  
Stuart, FL 34997  
(407) 283-8029 (FL)  
(800) 228-7755 (USA)

Wholesale distributors for padlocks,  
entrance locks, key blanks,  
miscellaneous hardware.

**KEY SALES & SUPPLY CO.**

9950 Freeland Ave.  
Detroit, MI 48227  
(800) 445-KEYS  
FAX: (313) 931-7758



Key Sales & Supply Co.

Continued from page 104

Key Personnel: Sheldon Wiener, Pres.; Michael Wiener, VP  
Full line stocking distributors of key blanks, key machines, locks, locksmith supplies and hardware.

See ad on page 127

**Keystone Safe & Equip. Wholesalers**  
625 South Eighth St.  
Philadelphia, PA 19147  
(215) 627-7736

Key Personnel: Edward C. Dornisch, Pres.; Patricia Krause  
Keystone Safe & Equipment Wholesalers are exclusive distributors of the Keystone "Protector," one and two hour fire safes and computer safes and the "Keystone Viking" burglary resistive fire safe. Distributors of other selected safe manufacturers.

**M.D. Kramer Locksmith Supplies**

535 Liberty Ave.  
Brooklyn, NY 11207  
(718) 647-7800, (800) 221-9674  
FAX: (718) 277-5624

Key Personnel: Joel Kramer, Pres.; Joseph Saluptoni, Mktg. Mgr.  
One of the largest distributors of popular or hard-to-find products.

**Leading Edge Tool Co.**

3001 Redhill Ave. 5-205  
Costa Mesa, CA 92626  
(714) 549-7027  
FAX: (714) 549-7027

Key Personnel: Rick Barbarossa, Owner; Jim Rawls, Co-Owner  
Special aerospace quality "tight fit" drilling tools to speed the installation

of locks, security systems and related hardware where normal drilling tools simply don't fit. Distributors of the "tight fit drill kit" and related accessories for the locksmith and security system installer.

**David Levy Co. Inc.**

12753 Moore St.  
Cerritos, CA 90701  
(310) 404-9998  
FAX: (310) 404-9698

Key Personnel: John Latino, VP; Allen Shiffman, Nat'l Sales Dir.

The David Levy Co. is an importer and distributor of electronic parts and accessories. Product emphasis is in vehicle security, cellular phone accessories, test equipment and general line electronic parts.

**Lockmasters Inc.**

5085 Danville Rd.  
Nicholasville, KY 40356  
(606) 885-6041 (800) 654-0637  
FAX: (606) 887-7093

Key Personnel: Clayton Miller, Pres.; Mark Miller, Sales Dir.; Wes Day, Ed. Dir.

Lockmasters has now been in business for over 35 years teaching courses ranging from safe lock servicing to professional locksmithing. Over the years, Lockmasters has also become a major supplier for safe tools and equipment. Ranging from borescopes and drillings to combination locks and safe deposit locks.

Locks Co.

2050 N.E. 151 St.  
N. Miami, FL 33162  
(305) 949-0700, (800) 288-0801 (Nat'l)  
FAX: (305) 949-3619

Key Personnel: Milton Dorn, Pres.; Mark Dorn, VP

Full line distributor with all major lines in stock. High security lines such as Medeco, ASSA, Abloy, and Schlage Primus are no problem. We also cover electronic locks and entry systems. We specialize in product knowledge and delivery time.

**The Locksmith Store Inc.**

1229 E. Algonquin Rd., Unit E  
Arlington Heights, IL 60005  
(708) 364-5111  
FAX: (708) 364-5125

Key Personnel: Tom Swiderek, Pres.; Jack Swiderek, Bob Szabo, Rico Chavez

**LSDA**

7330 W. Montrose  
Chicago, IL 60634

Full line stocking distributors of all major brands of door hardware and security products. Also marketing the LSDA private brand of products which is sold only through locksmith dealers. Available from these distributors: Acme Wholesale Distributors, Armstrong's Lock & Supply Inc., Canada Lock Products Ltd., Cooks Supply Co., Hardware Sales & Supply Co., H. Hoffman Co., and M. Taylor Inc.

See ad on page 49



**Don't panic!  
We have  
Security Exit  
Devices.**

[Click here for more information](#)



**To be a World Leader  
You Need Quality  
Products, Innovative  
Technology and  
Strong Partners.**

[Click here for more information](#)

**MAYFLOWER SALES CO., INC.**  
614 Bergen St.

Brooklyn, NY 11238  
(718) 622-8785, (800) 221-2052  
FAX: (718) 789-8346

Key Personnel: Bill Swetow, Pres.;  
Harris Goldstein, VP; Brian O'Dowd,  
Mgr.

Adams-Rite, All Lock, American Lock,  
Arrow, Auto Security, Briggs &  
Stratton, Chicago Lock, Corbin, Detex,  
Folger Adam, Gardall Safes, HPC, Ileo,  
Lori/Kaba, Marks, Master, Medeco,  
National Lock, Parker, Rofu, Sargent,  
Securitron, Security Engineering,  
Simplex, Star Safes, Yale. Full line  
distributors of locksmith supplies and  
builders hardware. Since 1917.

See ad on page 120

**Mazer Wholesale**

6228 Girard Ave.  
Philadelphia, PA 19151  
(215) 747-7900, (800) 343-0780  
FAX: (215) 471-6415

Key Personnel: Andrew Mazer,  
Owner; Laura DerMarderosian, Nat'l.  
Sales; Harry Hatfield, Local Sales

Mazer Wholesale is a  
hardware/houseware distributorship.  
We service the locksmith trade by  
supplying imported locks, padlocks,  
door hardware, keyblanks, and close-  
outs. Concentration is on fast delivery,  
competitive pricing, and excellent  
service. We're a young, energetic  
company on-the-move, and are willing  
to serve you. (No minimum order.)

**Maziuk & Co., Inc.**  
1251 W. Genesee St.  
Syracuse, NY 13204

(315) 474-3959, (800) 777-5945

FAX: (315) 472-3111

Key Personnel: Stanley Maziuk, Jr.,  
Pres.; Stanley Maziuk Sr., Treas.; Karen  
Bolich, Mgr.-Cust. Svc.

Since 1943, Maziuk & Co. has provided  
personal attention and fast service to  
our customers. Over 135  
manufacturers are in stock including:  
Alarm Lock, Arrow, Briggs & Stratton,  
Corbin, Folger Adam, Kwikset, Master,  
Schlage, Simplex, Von Duprin, Weiser,  
Yale. Maziuk & Co. is large enough to  
provide you with the selection and  
prices you need without losing the  
"personal touch."

**MCDONALD DASH LOCKSMITH  
SUPPLY, INC.**

1584 Two Place 38116  
P.O. Box 38186-0907  
Memphis, TN 38186-0907  
(800) 238-7541, (901) 346-8111  
FAX: (901) 346-8210

Key Personnel: Bette Arndt, Asst. to  
Pres.; F.R. Ferguson, Pres.; Jim Thomas,  
CM.; Burma Hanson, Office Mgr.  
Wholesale distributors of 15,000  
inventory items of 100 plus  
manufacturers to locksmiths, hospitals,  
schools and other institutions since  
1945. Locks, locksmith tools, closers,  
exit devices, key machines, lock parts,  
key blanks, and technical books. Same  
day shipment of orders in by 12:00 CT.

See ad on page 11

**McManus Locksmith Supply, Inc.**  
1309 Central Ave.  
Charlotte, NC 28205

(704) 333-9112

Key Personnel: John W. Dyson, Pres.;  
Ben Lewis, VP; Lucille Mondy,  
Sec'y./Treas.; Betty Lewis,  
Bookkeeper/Mgr.

**METRO SAFE CO., INC.**

30845 John R  
Madison Heights, MI 48071  
(313) 585-7230  
FAX: (313) 585-8705

Key Personnel: Orest R. Kalba, Pres.;  
Ereny "John" Szechowycz, VP  
Distributors for: Amsec, Brown,  
Cannon, International, Kaso, Safe  
Corporation, and introducing an all  
new line of Metro Safes including  
home and office units: TL-15 and TL-  
30. We ship throughout the continental  
United States and Canada.

See ad on page 92

**Midland Hardware Dist.**

P.O. Box 7043  
13 Raritan Rd.  
Oakland, NJ 07436  
(800) 526-9000 (Nat'l),  
(800) 562-2059 (NJ)

FAX: (201) 337-7695  
Key Personnel: John Warren, Dir.-Op. &  
Safes; Frank Begnoche, Dir.-Purch./Mktg.  
We are a stocking distributor of door  
hardware for the following  
manufacturers: Baldwin, Dexter,  
Kwikset, Marks, Norton, Omnia,  
Precision, Schlage, Simplex/Unican  
and Von Duprin. Orders shipped same  
day if placed by 2 EST. Call about our  
catalog.

Continued on page 110



**HPC has it all:  
Key Machines,  
Software, Books, Car  
Openers, Pick Sets,  
Tools, Door Guards,  
and Key Cabinets**

[Click here for more information](#)



**LOCKMASTERS  
SECURITY  
MANAGEMENT**

TM

**Providing quality tools,  
parts, and service for the  
security professional.**

[Click here for more information](#)



Continued from page 107

**Mid-South Locksmith Supply, Inc.**  
4176 New Getwell  
Memphis, TN 38118  
(901) 795-6987 (800) 238-6166  
FAX: (901) 795-3475

Only the finest locksmith supplies and security products for 15 years.

**Mid-States Security Corporation**  
247 Woodwork Ln.  
Palatine, IL 60067  
(708) 358-0760

FAX: (708) 358-0390

Key Personnel: K.C. Gullett, Pres.;  
Mitch Gullett, VP;

Our products include Adams Rite,  
Adam Lock, American Lock, Detex,  
Fort Lock, Master, Medeco, Norton  
Door Closers, Rofu, Simplex/Unican,  
Trine and Yale Master Key Systems,

rekeying and servicing of Medeco, Fort  
Lock, American and Simplex/Unican  
is our specialty. Medeco restricted  
keyway, cam locks, switch locks are  
stock items.

**MIDWEST WHOLESALE HDW.**

5121 Front St.  
Kansas City, MO 64120  
(800) 821-8527

FAX: (800) 621-6581

Stocking wholesale distributor for  
Schlage, Russwin, Yale, Ives,  
Simplex/Unican, LCN Closers, Detex,  
Bonmer, Norton, H. Soss Hinges and  
Von Duprin. Same day shipment on  
stock items. Call or fax toll free for our  
price catalog. Ask about our prepaid  
freight policy.

See ad on page 137

**H.E. MITCHELL CO.**

P.O. Box 14009  
Portland, OR 97214  
(503) 236-9444, (800) 626-5625  
FAX: (503) 238-5715

Key Personnel: Mike Messing, Judy  
Messing, Bob Thompson

See ad on page 24

**MONACO LOCK CO. INC.**

Jersey City, NJ 07306  
(800) 526-6094

FAX: (201) 659-7970

Monaco Lock Company is a major  
authorized stocking distributor of  
electric locking devices, access control  
equipment, detention products, and  
door hardware. Monaco's 25 year  
reputation is one of customer  
satisfaction, dependability, and  
personalized service. Our Vol. VII  
catalog features our complete product  
line in stock and ready for shipping  
nationwide.

See ads on pages 26, 93

**Paul Moore Company**

77 Circle Freeway Dr.  
Cincinnati, OH 45246  
(800) 543-1677

FAX: (513) 870-9771

Key Personnel: Jean Boggs, Tom Taylor,  
Sales.

Paul Moore Company specializes in  
hard-to-find hardware such as hinges,  
locks, forgings, etc. Our free catalog is  
available upon request.

**J. NATHAN HDW. SPEC. INC.**

161 Comfort St.  
Rochester, NY 14620  
(716) 325-3330

(800) 634-2580 U.S. and Canada

FAX: (716) 537-1940

Key Personnel: Jim Bono, Pres.; Toni  
Caiola Bono, Sec'y./Treas.; Mark  
Putnam, Cust. Svc.

Our business obligation is meeting  
customers needs by offering service and  
knowledge. We maintain a large  
inventory of locks, locksmith supplies  
and builder's hardware, such as  
Schlage A-M series, Kwikset in every  
function, finish and design. Complete  
line of Master Lock with over 200 key  
alike numbers in stock. Dexter Lock  
including Old Colony along with  
Medeco/Medeco Biaxial, Iico, ESP,  
National Cabinet, Yale, Securitron and  
over 100 other manufacturers.

See ad on page 155

**THE NATIONAL LOCKSMITH**

1533 Burgundy Pkwy.  
Streamwood, IL 60107  
(708) 837-2044

FAX: (708) 837-1210

Key Personnel: Marc Goldberg,  
Editor/Publisher; Tom Miodoch, Ad  
Sales Mgr.; Debbie Schertzing, Sales  
The National Locksmith magazine  
informs you monthly about all news  
and technical information you need.  
We publish a series of technical books  
and code books to educate locksmiths.

**New England Door Closer, Inc.**  
694 Union St., P.O. Box 28  
West Springfield, MA 01090



**Every Installation  
Is a Self-Portrait  
Of the Person Who Did It.  
Autograph Your Work  
with Excellence.**

[Click here for more information](#)

Continued on page 112

Continued from page 110

(413) 733-7889  
FAX: (413) 731-8368  
Key Personnel: R.E. Longley, Pres.  
New England Door Closer offers repair of current and obsolete door closers, is a stocking distributor of new door closers for Corbin, Dorma, Dor-O-Matic, Jackson, Kawneer, LCN, Norton, Rixson, R&K, Russwin, Yale and have in stock many of the replacement parts needed to fix a door closer problem.

**New York Locksmith Supply Co. Inc.**  
1558 2nd Ave.  
New York, NY 10028  
(212) 737-0178 (914) 328-1919  
FAX: (212) 988-9192  
Key Personnel: Neal Geffner, Pres.; Barry Silver, Nat'l. Sales Mgr.; Len Geffner, Financial Secy.

**OHIO TRAVELING BAG MFG. CO.**  
811 Prospect Ave.  
Cleveland, OH 44115  
(216) 621-5963  
FAX: (216) 621-5559  
Key Personnel: Paul Gallin, Bruce Oppenheim, Ray Patel.

Specialized distributor of luggage locks, keys and related hardware and handles. Catalog 791, \$10 payable in advance. Also publishes Catalog 790 free, which shows small gift and travel items including carded leather key rings, key cases, and related products.

See ad on page 70

**OMAHA WHOLESALE HDW.**  
1201 Pacific Street  
P.O. Box 3628  
Omaha, NE 68103  
(800) 228-8694 (Nat'l. WATTS),  
(800) 228-2218 (NE WATTS)  
FAX: (402) 444-1663

Key Personnel: Jack Maun, Pres.; Jim Humpal, Sales Desk; Howard Westerberg, Sales Desk-Omaha Wholesale Hardware was introduced in the distribution field in 1985. Omaha Wholesale has experienced growth in each of the five years since it opened for business. Omaha Wholesale started with two product lines, Schlage Locks and Von Duprin panic devices. It has since added additional lines such as LCN, Norton, Medeco, Locknetics, Ives, Lori, Folger Adams, Sentronics, Dor-O-Matic, Locknetics, Alarm Locks, Mag. Security.

See ad on page 86

**Orchard Lock Distributors, Inc.**  
30 Edmund St.  
Hamden, CT 06517  
(800) 233-2146 (Nat'l WATS)  
(800) 547-5128 (CT WATS)  
(203) 865-8106 (Local)  
FAX: (203) 624-4083

Key Personnel: Larry Federico, Dir.-Operations; Bill Simmons, Nat'l Sales Mgr.; Paul Douglas, Account Exec. Orchard Lock Distributors is a full line, nationwide distributorship serving the locksmith trade. The many major brands in stock include Arrow, Schlage, Yale, Dexter, Weiser, Abloy, Medeco, American, Master and many others. Our new larger facilities allow us to serve our customers better with

more variety, faster delivery and competitive prices. Call us toll-free for expert personalized service.

**PASEK CORP.**  
9 West Third St.  
So. Boston, MA 02127  
(800) 628-2822  
FAX: (617) 269-0547  
Key Personnel: Lewis A. Alessandrini, Pres.

See ad on page 56

**Agencies W. Pelletier (1980) Inc.**  
6700 Park Ave., Ste. 100  
Montreal, Quebec  
Canada H2V 4H9  
(514) 276-6700  
FAX: (514) 276-9413  
Key Personnel: A. Cheply, GM; M. Pare, Sales Mgr.; R. Crenier, Sales Rep.; M. LeGault, Cust. Svc. Mgr.  
Full line locksmith supply distributor. Key machines, key blanks, locksmith tools and supplies, locks, door closers, panic devices, electric strikes, high-security locks, safes, alarm systems. Prompt shipments. Since 1879.

**PERSONAL SECURITY**

**P.O. Box 496**  
**Hoosick Falls, NY 12090**  
(800) 116-6223  
FAX: (802) 442-3823  
Key Personnel: Jon Goodrich, Pres.; Dawn Raphan-Lee, VP Op.  
Distributor of Original Mace, muzzle Canine Repellent, the Big Jammer Door Brace and other quality self-protection and security products.

See ad on page 156

**The Peterzell Co.**  
P.O. Box 521357  
Longwood, FL 32752-1357  
(800) 848-1024  
Key Personnel: Victor Peterzell, Pres.; Betty Eichelberger, Off. Mgr.; Abe Peterzell, Sec'y.  
Personal protection devices, battery operated door and window alarms, key accessories, door viewers and door knocker viewers, and door annunciators.

**PIMLICO KEY SERVICE INC.**  
5242 Reistertown Rd.  
Baltimore, MD 21215-5082  
(800) 638-3815 (Nat'l)  
FAX: (301) 367-7319

Key Personnel: John Trouland, Pres.  
Locksmith supplies: Yale, Schlage, Kwikset, Sargent, Falcon, Arrow, Medeco, Lori, Unican, Ilco, HPC, Folger Adam, Corbin Cabinet, National, Marks, Adams Rite, Briggs & Stratton, Auto-Security, Valley Forge.

See ad on page 98

**Protect International**  
**Stun Gun Experts**  
100 W. Cherokee Ln. Ste. 8  
Lodi, CA 95240  
(800) 999-9310  
FAX: (209) 334-4101  
Key Personnel: L. "Deano" Bertalino, Sales Mgr.

**RA-Lock Company**

210 S. Clark St., Ste. B  
Cedar Hill, TX 75104  
(214) 291-1301  
Security for all coin operated machines. Cam locks, popout locks, t-handles, hasps, plug locks, safes, padlocks. Factory authorized service center.

**Racal-Chubb/Protection Group**  
29712 US Hwy. 19 North  
Clearwater, FL 34621  
(813) 785-0642  
FAX: (813) 784-9279  
Key Personnel: James R. Ringold, Pres.  
Offering a full line of electronic access control and UL listed physical security products. Including major technologies in access control, modular vaults, vault doors, safes and night depositories. Contact above for additional information.

**E.L. Reinhardt**  
3250 Fanum Rd.  
Vadnais Heights, MN 55110-5219  
(612) 481-0566, (800) 328-1311  
FAX: (612) 481-0166  
Key Personnel: Kenneth J. Stemig, Pres.; Kenneth D. Stemig, VP; John E. Stemig, VP

**Renaud Sales**  
P.O. Box 23056, Milton Mall  
Milton, Ontario L9T 5B4  
(416) 875-4471 (416) 875-6847  
Key Personnel: Joseph Renaud, Tech. Mgr.; Lisette Renaud, Order Proc.  
Exclusive authorized agent and distributor of Ikon products of Berlin, West Germany. Ikon is a manufacturer of quality cylinders since 1927, specializing in key control, masterkeying and control locking systems.

**Richmond Industrial Supplies**  
68 Port Richmond Ave.  
Staten Island, NY 10302  
(718) 448-2100  
FAX (718) 981-5665

**Rininger Lock & Supply**  
3468 Citrus St., Suite C  
Lemon Grove, CA 91945  
(619) 463-0170, (800) 266-0170  
FAX: (619) 697-2590  
Chuck Rininger, owner; Brian Goonan, sales, purchasing  
Major supplier for auto locks (foreign and domestic), locksmith tools, key blanks, padlocks, cam locks, entry locks, deadbolts, key machines and parts, code books, tryout keys, and guide keys. We ship nationwide and have an extensive "will call" area in our large warehouse with no minimum.

**Safeman Supply Co.**  
1104 N.E. 126th Ave.  
Van Couver, WA 98684  
Key Personnel: Dave McOmie, Pres.  
Books, tools and equipment for the safeman. Special products are Dave McOmie's safe books, a super template, and a safeman's transferring tool.

**Dave Sanders & Co. Inc.**  
107-111 Bowery

Continued on page 114



**Dave Sanders & Co. Inc.**

*Continued from page 112*

New York, NY 11226  
(800) 542-1743 (Nat'l),  
(212) 334-9898  
FAX: (212) 966-4185

Key Personnel: Paul Sheopaul, Sales Asst.; Shelly Averbach, Tech. Asst.  
Since 1952, Dave Sanders has been serving the trade community in the New York metro area. We stock an enormous inventory of building, cabinetry and door hardware. We specialize in commercial and decorative hardware and our line of power tools can't be beat. We are available from 8-4:30 p.m. Monday-Friday OEST.

Don B. Schmidt  
5513 6th Ave. S.  
Seattle, WA 98108

(206) 575-8066 (800) 822-8081  
(206) 763-7822

Key Personnel: Harold Spalter, Sales Mgr.; Elnora White, Bd. of Dir.

We are a locksmith wholesaler specializing in automotive locks. We are a full line stocking distributor of Briggs and Stratton and Auto Security Products. We also carry a full line of key accessories, including key fobs padlocks, and Lucky Line. We stock key blanks from Ilco, Silca, Star and ESP.

Security House Padlock Distributors

3-877 Alness St.  
Downsview, Ontario Canada M3J 2X4

(416) 661-5300

FAX: (416) 661-6313

Canada's factory source for Master

Lock, Dudley, American, Papaiz, PrestoLock, Squire, Cisa, Hampton.

**SECURITY LOCK DIST.**

59 Wexford St.

P.O. Box 815

Needham Heights, MA 02194

(617) 444-1155 (local)

(800) 847-5625

FAX: (800) 878-6400

Key Personnel: Sidney Schwartz, Pres.; David Schwartz, VP; Jeff Schwartz, VP; Martin D. Wiener, Controller  
Security Lock Distributors is a wholesale distributor of locks and security products. We are the nation's largest distributor of Arrow locks carrying their complete line. We also carry the complete inventories of Adams Rite, Folger Adam, Simplex, Bommer Mailboxes, Detex, Alarm Lock, Von Duprin collections, and Locknetics-Security Engineering. Our strengths are the depth of our lines as well as our knowledgeable sales staff.

See ad on page 114

Security Plus, Inc.

3612 North 16th St.

Phoenix, AZ 85016

(602) 234-3883,

(800) 822-7550 (AZ),

(800) 426-0200 (Nat'l)

Key Personnel: Steven E. Marcou, Pres.

Security Plus is a recently established wholesale lock distributor dedicated to providing excellent service to the locksmith industry. We are currently stocking products of major manufacturers of locksets, padlocks, safes, door hardware, key machines, key blanks, locksmith tools and various supplies.

Sell Hardware Distributing Inc.

117 South 27th Ave. West

Duluth, MN 55806

(218) 722-2328

Key Personnel: Don Sell

Sentinel Wholesale Hardware

Sentinel Diversified Industries, Inc.

2043 Wellwood Ave.

East Farmingdale, NY 11735-1283

(516) 753-6000

FAX: (516) 753-6004

Key Personnel: Alan Litroff

Wholesale distributors of architectural and builder's hardware including Medeco, Yale, Von Duprin, LCN, Magnetronics, Roton, Jackson, Rixson.

Serrubec Inc.

2069 Chartier Ave.

Montreal (Dorval), Quebec

Canada H9P 1H3

(514) 631-6791, (800) 361-0243

FAX: (514) 631-0494

Key Personnel: Joseph Mastro, VP

Wholesale locksmith supplies.

M. Shepse Co.

Div. Amco Bionics

21st and East Carson Sts.

Pittsburgh, PA 15203

(412) 381-4900 (800) 666-6007

FAX: (412) 381-5122

Key Personnel: Gilbert Shepse, Pres.;

**medeco**<sup>®</sup>  
HIGH SECURITY LOCKS

***Integrity.  
Ingenuity....  
security solutions.***

[Click here for more information](#)

Sandy Zarembeg, VP  
Kwikset, Weiser, Arrow, Sargent,  
Medeco, S&G, Master, National,  
Corbin, Cabinet, Iico, American,  
Stanley.

**Shield Supply & Services Ltd.**

Unit 17-1391 St. James St.  
Winnipeg, Manitoba  
Canada R3H 0Z1  
(204) 774-1921  
FAX: (204) 774-5627  
Key Personnel: C.M. "Coley"  
Kaufman, Pres./GM; Shawn McIntosh,  
Sales Mgr.  
Major lines: Abloy, Abus, American  
Lock, Auto-Security, Briggs & Stratton,  
ESP, Falcon, Framon, Grobet, HPC,  
Iico-Unican, Keymak, LAB, Medeco,  
National Lock, Rytan, Don-Jo Mfg.  
Centrally located Canadian wholesale  
distributor of security hardware and  
locksmiths' supplies and tools to the  
trade, contract hardware houses and  
government and municipal agencies.

**D. Silver Hardware Co., Inc.**

591 Ferry Street  
Newark, NJ 07105  
(201) 344-3963, (201) 344-4055  
(800) 222-2915 (NE)

**Silver Sales**

2701-C.W. 15th St., Ste. 291  
Plano, TX 75075  
(214) 867-4545, (800) 258-LOCK  
FAX: (214) 618-1897  
Key Personnel: Bill Silver, Judee  
Brummette-Silver

Carry a complete line of Sargent &

Greenleaf, Simplex/Unican and Roton  
products. Since 1982, supplying these  
and other fine security hardware  
throughout the U.S.

**SO-CAL**

2602-A Transportation Ave.  
National City, CA 91950-6654  
(619) 474-8847 (800) 521-3551  
FAX: (619) 474-2440

Ron Erbland, co-owner; Lin Erbland,  
co-owner

So-Cal, established 1980, stocks key  
blanks, auto locks (foreign and  
domestic), locksmith tools, novelties,  
key cabinets, and security cash  
handling equipment. No minimum  
purchase is required

See ad on page 30

**SOUTHERN LOCK & SUPPLY CO.**

10910 Endeavor Way  
P.O. Box 1980  
Pinellas Park, FL 34664-1980

(800) 282-2837 (FL),  
(800) 237-2875 (Nat'l)

FAX: (813) 544-2832

Key Personnel: Marvin Cutson, Pres.,  
David Matthies, VP-Op.

Southern Lock has been a supplier to  
the locksmith, security and building  
industries for more than 40 years,  
maintaining a large inventory of  
popular products from over 200  
manufacturers. With four locations,  
competitive pricing and friendly,  
qualified sales personnel, Southern is  
doing what it takes to keep their  
customers happy.

See ad on page 18

**Space Age Locksmith Supplies, Inc.**

P.O. Box 740240  
Orange City, FL 32774-020

(904) 775-4880 (800) 247-7942

Key Personnel: John Millan, Pres.  
Here at Space Age Locksmith Supplies  
we will give you personal attention.  
We are a stocking distributor for major  
manufacturers like All Lock, American,  
Star, Lucky Line, Valley Forge and  
others. We stock foreign and domestic  
car locks, key blanks padlocks, auto  
and house plates, key rings, pinning  
kits and more.

**Jack Stearman Ltd.**

338 West 6th Ave.  
Vancouver, B.C. Canada V5Y 1K2

(604) 872-8415

FAX: (604) 875-9174

Key Personnel: John Stearman, Pres.;  
Edna Nichols, Operation Mgr.

**Stone and Berg**

**Wholesale Locksmith Supply**

99-103 Stafford Street

Worcester, MA 01603

(800) 225-7405

FAX: (800) 535-5625

Key Personnel: Rick Brown, Sales  
Mgr.; Dick Brooks, Operations Mgr.;  
Phil Sandstrom, Purchasing Mgr.

**STRAUSS SAFE & LOCK CO., INC.**

1801 2nd Ave.

P.O. Box 716

Des Moines, IA 50314

(515) 288-9571

(800) 532-4107 (Nat'l WATS)

FAX: (515) 288-9752

**NATIONAL  
AUTO LOCK SERVICE, INC.**

National Auto Lock Service, Inc. offers a  
wide range of equipment and services for  
the Automotive Locksmith. From tools and  
hard to find key blanks to transponder

programming, we can take the mystery out of car service. We accept credit card  
orders, and can ship COD. Contact us for the latest in automotive technology.

[www.laserkey.com](http://www.laserkey.com)



**Choose S&G Comprometric  
electronic safe  
locks for...security...  
technology...tradition.**

[Click here for more information](#)



Strauss Safe & Lock Co., Inc.

Continued from page 115

Key Personnel: Jim Bianco, Pres.; Dan Swift, Sales; Bill Cunningham, Purchasing  
Founded in 1927, Strauss is one of the oldest locksmith suppliers in the Midwest. We specialize in Weiser, Schlage, Master, and Ilco to name a few.

See ad on page 129

**M. Taylor Inc.**  
5635-45 Tulip St.  
Philadelphia, PA 19124  
(An LSDA Company)  
(215) 288-5588,  
(800) 233-3355  
FAX: (215) 288-2511  
Key Personnel: Jules DeLuca, Pres.;  
Don Amole, Sales Mgr./Telemktg.  
Mgr.; Peggy Spadaro, Computer  
Coord.

We are distributors of most of the leading lines in our industry. M. Taylor Inc. has been in business for more than 80 years. We give service which is "Tailored" to your needs.

**Taylor Security & Lock Co., Inc.**  
8585 Atlas Dr.  
Gaithersburg, MD 20877  
(301) 948-7670 (800)676-7670  
FAX: (301) 948-1029  
Key Personnel: Joel Taylor, Pres.;  
Myrna Taylor, VP/Sec'y; Larry Dubit,  
VP-Op.

**TOP NOTCH DISTRIBUTORS**  
P.O. Box 189  
413 Erie St.  
Honesdale, PA 18431  
(800) 233-4210

**FAX: (717) 253-6765**  
**3688 Research Way**  
**Carson City, NV 89701**  
**(800) 722-4210**

Key Personnel: Brian Mikulewicz,  
Mgr.; Jim Williams (NV)

See ad on page 34

**Trans Atlantic**  
440 Fairmount Ave.  
Philadelphia, PA 19122  
(215) 629-0400, (800) 523-9956  
FAX: (215) 629-1282

Key Personnel: Norman Millman,  
Pres.; Berne Davis, Nat'l Sales Mgr.  
We are the oldest (est. 1951) stocking importer of high quality, commercial and residential grade builders and security products from the many outstanding off-shore manufacturers we represent for the USA market. We specialize in locks, deadlocks, rim and mortise cylinders, panic devices, door closers and door viewers.

**Turn 10 Wholesale**  
P.O. Box 746  
Marietta, OH 45750  
(800) 848-9790  
FAX: (614) 374-3322  
Key Personnel: Maribeth Miller, Cust.  
Svc.; Laura Jeanne Miller, Cust. Svc.  
Andy Miller, Cust. Svc.  
Stocking Gardall and Meilink safes. All orders receive: free freight, 3 levels of discounts, complete selection, no minimums, free literature and sales aides, and delivery within 1-5 days.

**Tweeds Locksmith Inc**  
Wholesale Supply Div.

601 Elm Ave.  
Portsmouth, VA 23704  
(804) 399-2180  
FAX: (804) 399-1636  
Key Personnel: Ernest F. Floyd, Jr.,  
Pres.; Gary A. Waterman, VP; Patricia  
C. Floyd, Sec'y/Treas.  
Wholesale distributors, retail sales and services for over 40 years. Distributors of all leading manufacturers, S&G, Kwikset, Ilco, Master Lock, Schlage, American Lock, Simlex, electronic cypher locks, etc.

**Union Iron & Metal Co., Inc**  
2820 Holmes Rd.  
Houston, TX 77051  
(800) 237-0255, (713) 799-9960  
FAX: (713) 799-8483  
Key Personnel: Ron Higgins, Exec. VP;  
Mallory Hoffman, VP; Miguel Araujo,  
Sales

**United Safes of America**  
1316 Bruce Rd.  
Oreland, PA 19075  
(800) ALL-SAFE  
FAX: (215) 886-4305  
Key Personnel: Richard J. Weaver,  
Pres.; JoAnn Di Pasquale, Office Mgr.  
Distributing Meilink, Fire-King,  
Adesco, Detroit Mini Safe, Tear Gas  
and personal protection devices.

**U.S. Lock Corporation**  
77 Rodeo Dr.  
Brentwood, NY 11717  
(800) 525-5000

Continued on page 118



**STRATTEC™**

*The world's largest producer of  
automotive locks and keys.*

Click here  
for more  
information

**SRI**  
**SECURITY**  
**RESOURCES INC.**

Click here for more information

**SRI and Tech Train  
Productions are the  
automotive specialists -  
your best source for  
automotive tools,  
manuals, and videos.**

U.S. Lock Corp.

Continued from page 116

FAX: (800) 338-LOCK  
Key Personnel: Bob Bloom, VP-GM;  
Jim Ellis, VP-Advertising  
U.S. Lock is a distributor,  
manufacturer, packager and importer  
of U.S. Lock brand products and all  
national brands of security hardware.  
U.S. Lock Security Centers are a  
nationwide network of authorized U.S.  
Lock dealers that retail U.S. Lock  
products as well as national brands.

**Veehoff Supply Co.**  
1515 Lake Ave.  
P.O. Box 361  
Storm Lake, IA 50588  
(712) 732-1836  
Key Personnel: B.H. "Ben" Veehoff,  
Owner  
Nationwide distributors of automobile  
masterkey sets, car unlocking tools,  
and Star key blanks. We ship to all 50  
states and Canada.

**Wadsworth White Inc.**  
5873 New Peachtree Rd., Ste. 100  
Atlanta, GA 30340  
(404) 458-9449  
FAX: (404) 452-7378

**Ray Ware Hardware**  
4048 Herschel St.  
Jacksonville, FL 32205  
(904) 389-6659  
Key Personnel: Tom Jones, Ken Kuder

**Whareo**  
305 North First St.  
P.O. Box 549  
Martins Ferry, OH 43935  
(800) 848-5440 (Nat'l)

(800) 628-1133 (OH)  
FAX: (614) 633-5779  
Key Personnel: Paul Parnell, Mgr.

**Wholesale 4 Inc.**  
706 S.E. Grand Ave.  
Portland, OR 97214  
(503) 238-8605  
FAX: (503) 235-5636  
Key Personnel: Nancy Burt, Mgr.;  
Siobhan Mahoney, Sales; Lisa Drog,  
Sales

Our main objective is service with  
same day shipping on any stock item.  
Special orders not a problem either.  
Large inventory including Auto  
Security, ESP, Ileo, Briggs & Stratton,  
All-Lock, Adams Rite, Kwikset, Master,  
Schlage, Weiser, Fort Lock, HPC, and  
much more.

**Wilco Supply**  
5960 Telegraph Ave.  
Oakland, CA 94609  
(800) 745-5450  
FAX: (415) 653-KEYS  
Key Personnel: H.D. Williams, Pres.;  
R.D. Williams, VP-Op.; Jonathon  
Clarner, Sec'y./Treas.  
Over 28,000 inventory items:  
hardware, builders hardware, tools,  
adhesives, and locksmith supplies.  
Serving California, Oregon and  
Nevada.

**WILLIAMS KEY CO., INC.**  
2206 Locust St.  
St. Louis, MO 63103  
(314) 231-2411, (800) 325-1779  
(Nat'l)  
FAX: (314) 231-4609

Key Personnel: Erma L. Williams,  
Pres.; Mike Rachocki, GM; George  
Koester, Op. Mgr.  
Williams Key Co. was started in 1968  
as a key company selling to local trade.  
In 1974 it was incorporated and  
expanded to carry locks and padlocks.  
We now carry products of over 100  
major manufacturers that include all  
locksmith tools, locks, and hardware.  
We have a 500 page catalog available.  
**See ad on page 74**

**Yohar Supply**  
P.O. Box 327  
Elyria, OH 44036  
(800) 362-7416  
Key Personnel: Lloyd N. Lopez

**Samuel Zeldin Inc.**  
1700 North 5th St.  
Philadelphia, PA 19122  
(215) 236-8600  
Key Personnel: Claire Zeldin, VP  
Automotive locks is our business.  
Serving the entire United States.

**ZIPF LOCK CO.**  
830 Harmon Ave.  
Columbus, OH 43223  
(614) 228-3507, (800) 848-1577  
FAX: (614) 228-6320  
Zipf Lock Co. was established in 1905.  
We specialize not only in the popular  
locks but also the hard to find lock  
functions and designs in Arrow,  
Kwikset, Schlage, Dexter, Weiser and  
many more. We are constantly adding  
to our inventory of over 15,000 items.  
Give us a call.  
**See ad on page 41**



**SCHWAB CORP.**

*Fire protection for your vital records.*

***It's not safe unless  
it's Schwab Safe.***

[Click here  
for more  
information](#)



**ASP - Your Auto  
Service Center  
for the World**

[Click here for more information](#)



# Schools

**ACME SCHOOL LKSMTHG. DIV.**  
11350 S. Harlem  
Worth, IL 60482  
(708) 361-3750

Acme's Locksmithing Course was developed for the individual with no experience or prior training, but who wishes to learn the craft and begin a locksmithing career, or for the individual with previous experience who wants to expand and further his abilities and techniques. This course is an in-house, hands-on, training program where you will learn by doing.

See ad on page 26

**COLORADO LOCKSMITH COLLEGE INC.**

4991 W. 80th Ave., Unit 103A  
Westminster, CO 80030  
(303) 427-7773

Key Personnel: Howard Smith, Pres. Colorado Locksmith College credits its growth success to the fact that we teach established courses, customized courses, and one lesson courses to our students. We believe in supply and demand; you supply the need and we meet the demand.

See ad on page 139

Foley Belsaw Institute  
6301 Equitable Rd.  
Kansas City, MO 64120  
(800) 821-3452 (orders only)

(816) 483-2700 (customer service)

Golden Gate School Of Lock Tech.  
3722 San Pablo Ave.  
Oakland, CA 94608  
(510) 654-2677

Key Personnel: Edwin W.L. Scott Jr., Dir.; Charlie L. Cunningham, Chief Instr.

Our school utilizes a unique teaching technique in an effort to turn out good, potential employees for the locksmith industry. For those who qualify, we also offer two week short term courses in just about any aspect of locksmithing. We also offer three week short term courses.

**HPC LEARNING CENTER**

P.O. Box 2093  
Schiller Park, IL 60176  
(708) 671-6284

FAX: (708) 671-6343

Key Personnel: Jerry Hoffman, Chief Educational Off.; Alan Goeke, Mgr. HPC Learning Center offers state board of education accredited courses in both basic and advanced locksmithing. Available in two convenient formats:

\*Evening-Two nights per week (12 weeks, total 84 hours).

\*Intensive-Two week Monday-Friday, (45 hours per week-total 90 hours).

Call or write for further information.

**LOCK & SAFE INST. OF TECH.**

1650 North Federal Hwy.  
Pompano Beach, FL 33062  
(305) 785-0444

Complete locksmith course is offered at our South Florida campus. Practicing locksmiths may learn any subject area. Our students learn through "hands on" and field experience. Graduates are given a 24 hour, seven days a week hotline for technical information and help.

See ad on page 120

**Lockmasters Inc.**

5085 Danville Rd.  
Nicholasville, KY 40356  
(606) 885-6041

FAX: (606) 885-7093

Key Personnel: Clayton Miller, Pres.; Wes Day, Ed. Dir.; Allan Halverson, Chief Instructor

Educational Classes: Residential Locksmithing and all safe and vault related courses. Correspondence: safe lock servicing, safe lock manipulation, safe deposit servicing, lock picking. Monthly trade magazine: Safe & Vault Technology; and trade association: Safe & Vault Technicians Association.

**LOCKSMITHING INSTITUTE OF AMERICA, INC.**

116 Fairfield Rd.



*Don't panic!  
We have Security  
Exit Devices.*

[Click here for more information](#)

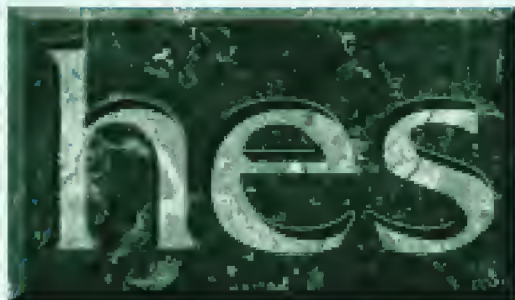

**The Innovation You  
Expect, with the  
Flexibility You Need!**

[Click here for more information](#)

**Fairfield, NJ 07004**  
(800) 526-0890,  
(201) 575-5225 (NJ)

Key Personnel: John P. Regan, Pres.  
The Locksmithing Institute of America, Inc., has been in business since 1948. We offer a complete training program in professional locksmithing and have taught tens of thousands of students all over the world since our inception.

See ad on page 98

**NORTH BENNETT ST. SCHOOL**  
392 North Bennett Street  
Boston, MA 02113  
(617) 227-0155

Key Personnel: Victor Swanson, Instr.; Roy Nielsen, Dir.-Admissions  
Founded in 1885, NBSS is an accredited member of NATTS. Specializing in hand tool skills, we offer 1170 hours of training in servicing all mechanical residential and commercial door-locking devices, set-up of master-key systems, install locks, service automotive locks, and servicing of combination locks..

See ad on page 40

**NRI SCHOOL OF LKSMG.**  
4401 Connecticut Ave., NW  
Washington, DC 20008  
(202) 244-1600

Key Personnel: Bill Coleman, Exec. Dir.; Tyrone Robinson, Senior Instr.; Rick Hopkins, Training Coord.  
Locksmithing and electronic security training is now available from NRI Schools. NRI gives you training in both locksmithing and electronic security

systems in one complete new course. You train at home, according to your schedule. Write to us today for your free catalog.

See ads on pages 37, 133

**PINE TECHNICAL COLLEGE**  
1000 4th St.  
Pine City, MN 55063  
(800) 521-7463

Key Personnel: John Heckman, CML, Instr.; Jay Hutchins, Dean-Student Svc.  
Pine Technical College, located 60 miles north of Minneapolis/St. Paul, is one of Minnesota's 34 technical colleges. In addition to other business and trade programs, the college offers a 96 credit (two year) diploma in locksmithing technology. The program (including internship) encompasses all aspects of the planning, installation, management, and repair of locks, electronic security, and allied systems.

See ad on page 59

**Quintilian Institute**  
5001-A Lee highway #101  
Arlington, VA 22207  
(703) 525-7525  
FAX: (703) 243-5476

Key Personnel: Richard Blackmon, Principal  
The Professional Locksmith Training School of the Quintilian Institute offers resident classes at the entry level and advanced level. Each of these intensive six day programs utilizes teaching methods proven in our military intelligence programs, rely on extensive practical exercises to develop

skills, and employs the most effective tools and techniques.

**Security Education Plus**  
P.O. Box 497  
Nicholasville, KY 40356  
(606) 887-6027  
FAX: (606) 885-7258

Key Personnel: Rex E. Parmelee, Pres.  
Formed in 1985, we provide the security industry with on-site training programs relating to safes, vaults and other types of security containers that incorporate combination lock, time locks and key locking mechanisms.

**Universal School of Master Lksmg.**  
3201 Fulton Ave.  
Sacramento, CA 95821  
(916) 482-4216

Key Personnel: Rick Vanina, Pres.  
Correspondence and shop training. Working shop environment.

**Valley Technical Institute**  
5408 N. Blackstone Ave.  
Fresno, CA 93710  
(209) 436-8501  
FAX: (209) 439-3814

Key Personnel: C. Haven Young, Dir./Instructor  
New classes starting four times a year. Basic locksmith class lasting 9 weeks will cover: lever and warded locks, disc/wafer tumbler locks, pin tumbler and automotive locks. Advanced locksmith class lasting 3 weeks includes masterkeying and safe maintenance. Hands-on labs included. Externships available after completion of programs. Send for catalog.



**HPC, Inc.**  
**Designing Excellence and Manufacturing**  
**Quality since 1956**

[Click here for more information](#)



# Alarm Monitoring

## ALARM MONITORING SVC., INC.

5021 Fairfield St.  
Metairie, LA 70006  
(504) 454-2163  
FAX: (504) 454-8706

Key Personnel: Dera A DeRoche, Pres.; Tammy Bennet, Oper. Mgr.  
Alarm Monitoring Services, Inc. was founded in 1980. The company provides alarm monitoring services exclusively for dealers. We are dedicated to providing the most sophisticated alarm monitoring services available anywhere.

See ad on page 61

## Central Alarm Control, Inc.

13973 SW 140 Street  
Miami, FL 33186  
(305) 238-0800, (800) 288-6522  
FAX: (305) 378-4563,  
(800) 933-4563

Key Personnel: Robert Boudreaux, GM  
Central Alarm Control, Inc. offers all phases of digital alarm monitoring, long range radio, and derived channel providing service for security, fire, life safety, medical environmental and elevator telephone system. The U.L. listed central station serves over 500 independent installing companies nationwide. C.A.C. has served the industry since 1982.

## CSSS, Inc. dba Central Station Security Systems

50 S. Anaheim Bl. #250  
Anaheim, CA 92805  
(800) 843-8526  
FAX: (714) 956-6264

Key Personnel: Robert M. Johnson, Pres.  
UL listed monitoring service established 1978. Monitoring over 35,000 locations for alarm companies and major chain stores throughout the USA. Triple redundant computer system, redundant backup power and telephone lines. Highest trained team

in the industry.

## Grand Central Station

23194 Kidder St.  
Hayward, CA 94545  
(800) 458-4519  
FAX: (510) 887-7364

Key Personnel: Mike Cooke, Mgr.; Lisa Fontillis, Dealer Support  
Grand Central Station is an Underwriters

Laboratory listed central station dedicated to supporting dealers with quality wholesale monitoring of burglar and fire alarms. G.C.S. can show you how to increase your profits on all monitoring jobs. We can provide direct billing for your clients monitoring and return profits to you.

## Inter Innovation LeFebure

308 29th St. NE  
Cedar Rapids, IA 52406  
(319) 369-5000  
FAX: (319) 366-2608

Key Personnel: Arne Samuelsson, Pres.; Jim McHalle, VP-Mktg.; Gene Hobart, VP-Service

## Monital Signal Corp.

1433 Highway 34  
Farmingdale, NJ 07729  
(800) 631-2299  
FAX: (201) 438-2335

Key Personnel: Ray Sacks, Pres.; Rich McKelligett, Dir.-Op.  
Nationwide alarm monitoring and telephone answering service for the security industry only. Down loading of alarm histories and answering service messages to on sight printers at dealers' premises.

## National Alarm Computer Center, Inc.

P.O. Box 12520  
Santa Ana, CA 92712  
(714) 834-1208  
(800) 854-3392 (Outside CA)  
(213) 687-3917  
FAX: (714) 543-6719

N.A.C.C. is a complete all-service U/L monitoring central station for licensed alarm companies, offering a wide variety of state-of-the-art monitoring techniques for all makes of digital dialers and alarm panels. N.A.C.C. Inc. is equipped with a fully redundant computer system.

## National Guardian Security Service Corp.

Suite 550, 155 S. 5th Ave.  
Minneapolis, MN 55401  
(612) 336-4377  
FAX: (612) 333-8358

Key Personnel: Craig Leiser, VP Dealer Op.; Serr Wargin, Office Supv.; Becky Smithwick, Dealer Support Svc.  
National Guardian dealer operations has served the monitoring needs of dealers and their customers since 1977. We offer selected hardware purchase and marketing assistance to qualified dealers.

## SECURITY CENTRAL

312 Park Drive  
P.O. Box 5754  
Statesville, NC 28677  
(704) 872-9857  
(800) 222-2579 (NC),  
(800) 438-4171 (USA)  
FAX: (704) 878-0309

Key Personnel: Gayle H. Brown, Monitoring Sales Mgr.  
Security Central is a UL and FM approved 24-hour nationwide automated central station. All services are via WATS lines, thereby maintaining low-costs. Residential, commercial, industrial and agricultural properties are all a part of the Security Central monitoring network. Marketing, sales and technical assistance available. Security Central has been serving hundreds of dealers nationwide for 20 years.

See ad on page 107



**Lockmasters has a 44  
year history of training  
security professionals.**

[Click here for more information](#)

# Miscellaneous

**The Aardvark Extractor**  
5225-R Stevens Creek Blvd.  
Santa Clara, CA 95051  
(408) 249-9735

Key Personnel: Charles Frazer, owner  
Stainless steel micro forceps with serrated jaws that open at the tip of a single shaft for removing broken keys tips or small objects from hard to reach areas.

**Abbeon Cal Inc.**  
123 Gray Ave.  
Santa Barbara, CA 93101-1895  
(805) 966-0810, (805) 963-7545  
FAX: (805) 966-7659

Abbeon Cal is an industrial mail-order company. Our 500 page catalog includes all types of instruments, as well as laboratory, plant, industrial and drafting supplies.

**Air Louvers Inc.**  
8455 E. Loch Lomond Dr.  
Pico Rivera, CA 90660-0988  
(213) 948-3495  
FAX: (213) 949-4661

Key Personnel: Lou Majesko, Gen. Mgr.; Ernie Strickland, VP Sales; Shari Pendleton, Mgr. Customer Svc.  
Air Louvers Inc. manufactures a full line of louvers and vision frames for commercial doors.

**American Eagle Sales**  
P.O. Box 1091  
Grants Pass, OR 97526  
(503) 479-6497  
FAX: (503) 474-1325

Key Personnel: Herbert R. Bell, Owner; Shirley M. Bell, Co-owner  
Originator and designer of a locksmith belt buckle that truly depicts the locksmith image. The buckle is available both in pewter and brass finishes.

**Audio Alert Systems Of America, Inc.**  
4208 Dover Rd.  
Louisville, KY 40216  
(502) 448-6699  
FAX: (502) 448-0018

Key Personnel: Lisa Hayes, Mktg. Supervisor  
E-Z Tone Magnetic Door Announcer completely non-electric. Needs no batteries. Audible up to 5000 sq. feet. Handsome pearl gray and dark bronze exterior.

**Brazos Door and Hardware**  
3701 Brazos  
Odessa, TX 70764  
(915) 366-0405

**The Canadian Locksmith Inc.**  
137 Vaughan Rd.  
Toronto, Ontario M6C 2I9  
(416) 653-2199  
Key Personnel: Arnold Sintnicolaas

**Cape Townsend Inc.**  
507 Navarino St.  
Algoma, WI 54201  
(414) 487-5209

FAX: (414) 487-3660  
Key Personnel: Brian Davitt, Pres.; Allan Wartella, Gen. Mgr.; Dolly Franks, Wood Door Consultant  
Cape Townsend is a manufacturer and distributor of fine wood products including architectural wood and hollow metal doors and frames, wood mouldings and trims, casework, displays, plastic laminate items, and component parts. We have been in business for 12 years, and we have supplied materials throughout the U.S.

**D & T Services**  
Box 75344  
White Rock, B.C. Canada V4A 9N5  
(604) 531-5385  
Regional distributor for Rediline motor generators.

**Darex Corporation**  
Box 277-220 Hersey St.  
Ashland, OR 97520  
(503) 488-2224 (800) 547-0222 FAX:  
(503) 488-2229  
Key Personnel: Neal Kinzie, Sales Mgr.; David Bernard, Pres.  
Darex Corporation is known throughout the world as the leading producer of precision sharpening equipment for drills, endmills and taps. Darex sharpeners are simple, accurate and they will save you time and money. For complete information Darex has available comprehensive literature and a free video.

**Robert W. Fischer**  
5217 W. Flight Ave.  
Santa Ana, CA 92704  
(714) 892-1133, (714) 839-6272  
We sharpen all types of key duplicating machine cutters.

**Jon's Lock & Key**  
8918 So. 700 E.  
Sandy, UT 84070  
(801) 255-1003  
Key Personnel: Jon Vawdrey, owner; David Vawdrey, Mgr.  
We have manufactured the EZ Vats tool which simplified the making of a VATS key. This tool and the 15 Vats key blanks are all you need to originate the pass key. No connecting or disconnecting of any wires necessary. Simple, inexpensive, satisfaction guaranteed, \$49.95 plus \$3.50 shipping and handling.

**Kett Tool Co.**  
5055 Madison Rd.  
Cincinnati, OH 45227-1494  
(513) 271-0333  
Key Personnel: H. Rowe Hoffman, Chrm.; Wm. A. Berlier, Pres.; Rick Fowkes, Sales Mgr.  
Manufacturer of specialty cutting portable power saws, shears and nibblers for cutting sheet metal, wood and plastics.

**The La Tourette Company, Inc.**  
2636 West Main Street  
Los Angeles, CA 91801

(213) 682-2877  
Key Personnel: Clifford B. Cox, Pres.; Michael J. Rogers, VP  
Safe deposit/bank vaults specialists since 1925. Complete service and repairs, replacement locks, parts and keys. Broco thermal lance distributor/replacement rods.

**Locksoft, Inc.**  
P.O. Box 2660  
Gaithersburg, MD 20886-2660  
(301) 258-9245  
FAX: (301) 670-6199  
Key Personnel: Jon Payne, Pres.; Jerry Cohen, CM; Adam Blum, VP  
Locksmith industry software, masterkeying, key records, codes, point-of-sale, and accounting. Free catalog.

**Prime Line Products Co.**  
4185 Hallmark Pkwy.  
San Bernardino, CA 92407  
(714) 887-8118  
FAX: (714) 880-2906  
Key Personnel: Dick Crowther, Pres.; George Sutphen, VP  
Door reinforcing sleeves, high security strikes and screen/storm door latches and closers.

**Vern Rose Tool Processing**  
8605 Commerce  
San Diego, CA 92111  
(619) 560-9769

**Safety Technology International**  
2306 Airport Rd.  
Pontiac, MI 48054  
(800) 888-4784  
Key Personnel: Lori Lynn Taylor, Dir.-Mktg.; John F. Taylor, Nat'l Sales Mgr.  
STI's patented use proven products can stop what's bugging you-false fire alarms, fire extinguisher theft, smoke detector damage, vandalism of cabinet mounted fire gear, unauthorized use of fire exit doors, emergency door problems and more. Call today.

**Scosche**  
5160 Gabbert Rd.  
Moorepark, CA 93021  
(805) 523-0687  
FAX: (805) 523-0761  
Auto security encyclopedia.

**WOODWARD MFG. & SALES CO. INC.**  
P.O. Box 217  
Oostburg, WI 53070  
(414) 564-2323, (800) 558-3536  
FAX: (414) 467-8428  
Key Personnel: Elmer Hazen, Pres.; Larry Market, VP; Jerry Johnson, Sales  
Lectro Truck, a battery powered hand truck. One man moves load up to 600 lbs. and more. Maneuvers load with pushbutton ease up and down steps, on and off trucks, semis, vans, loading docks, around corners, over landings, bulkheads. Strong steel construction moves with greater safety 1500 lb. load.

See ad on page 158



# Manufacturer Reps

## Arizona

**Maxwell & Associates**  
10175 E. Corrine Dr.  
Scottsdale, AZ 85260  
(602) 451-1316  
FAX (602) 451-8187  
Territory: AZ, NM, CO, UT, NV

**G. C. Ratcliff Co. Inc.**  
2430 So. 20th St.  
Phoenix, AZ 85034  
(602) 258-5835  
FAX: (602) 252-0148  
Salespeople: Bill Baines, Bud Ratcliff,  
John Hamilton, Dawn Graves  
Territory: AZ, NM, El Paso, TX

**Randy M. Rehling**  
4175 W. Crocus Dr.  
Phoenix, AZ 85023  
(602) 938-1434  
Salesperson: Randy Rehling  
Territory: AZ, NM, El Paso, TX, Los  
Vegas, NV

## California

**A & M Sales, Inc.**  
P. O. Box 5098  
Huntington Beach, CA 92615  
(714) 549-5003  
FAX: (714) 549-7115  
Sales Person: Allan Oblath  
Territory: So. CA, So. NV, AZ

**Best Marketing Co.**  
2311 Elda St.  
Bradbury, CA 91010  
(818) 359-7579  
Salespeople: Denis Daines, Georgia  
Daines, Bob Ipema, Chuck Wilson, Bill  
Spivens  
Territory: So. CA, Las Vegas, NV, AZ,  
NM, El Paso, TX

**Brownell-Phillips, Inc.**  
P.O. Box 321  
Tustin, CA 92681  
(714) 544-8003  
FAX: (714) 544-9301  
Salespeople: J. Michael Brownell,  
Thomas Phillips, Dan O'Rourke, Chuck  
Jones  
Territory: Southern CA, AZ, Las Vegas,  
NV

**Cimaron Pacific**  
4911 Cabrillo Point  
Discovery Bay, CA 94514  
(510) 634-3395  
FAX: (510) 634-7577  
Salespeople: Matt Murphy, Gary Smith  
Territory: No. CA, No. NV

**Coffman Associates**  
1531 Eagle Park Rd.  
Hacienda Heights, CA 91745  
(818) 810-7337  
FAX: (818) 810-7337  
Salespeople: Barry Coffman, Harry  
Sandman

**Franken and Associates**  
20746 Elfin Forest Rd.  
Escondido, CA 92029

(619) 744-0366  
FAX: (619) 744-0366  
Salespeople: Suzi Franken, Kelly  
Sadowski  
Territory: So. CA

**Johnston & Dean**  
11923 Salem Dr.  
Granada Hills, CA 91344  
(818) 831-7788  
FAX: (818) 894-0280  
Salespeople: Ellen Johnston, John Dean  
Territory: So. CA, AZ, So. NV

**Nicolai & Associates**  
108 N. McPherson Rd.  
Orange, CA 92669-3721  
(714) 538-5515  
FAX: (714) 538-9339  
Salespeople: Steve Nicolai, Peter  
Nichols  
Territory: So. CA, So. NV, AZ

**Pacific Marketing Agency**  
P.O. Box 1274  
1437 Junewood Pl.  
Manteca, CA 95336  
(209) 823-9001  
FAX (209) 825-5447  
Salespeople: Tom Jackson, Helyett  
Jackson  
Territory: No. CA, NV

**Security West Co.**  
2211 E. 69th St.  
Long Beach, CA 90805  
(213) 633-4149  
FAX: (213) 630-8804  
Salespeople: Bill McQuaid, Dick  
Berreman  
Territory: 11 Western states

**Spectrum Associates, Inc.**  
1240 N. Jefferson, Suite M  
Anaheim, CA 92807  
(714) 630-3433  
FAX (714) 630-3061  
Salesperson: Dick Jensen  
Territory: So. NV, So. CA, HI

**Sprinkle & Associates, Inc.**  
2031 E. Cerritos Ave., Bldg. 7 Ste. 13  
Anaheim, CA 92806  
(714) 491-9320  
FAX: (714) 491-9496  
Salespeople: Bill Sprinkle, Don  
Cosarove, Don Meanrs, John Lauer,  
Bob Minnick  
Territory: So. CA, So. NV, AZ

## Canada

**Ironmonger**  
5200 Dixie Rd. #32  
Toronto, Ont. Canada L4W 2A7  
(416) 629-4900  
FAX: (416) 629-7730  
Salespeople: Paul Boyd, Paul Winicki  
Territory: Eastern Canada

**The Lauderdale Sales Co.**  
1-B Richview Rd., Suite 1106  
Etobicoke, Ont. M9A 4M6  
(416) 243-5354  
FAX: (416) 244-7765  
Salespeople: Barry Lauderdale, Robert

Renaud  
Territory: Eastern Canada

**Mouldens Ltd.**  
1497 Adanac St.  
Vancouver, BC V5L 2C4  
Canada  
Phone: (604) 253-7558  
Fax: (604) 662-8460  
Salesperson: Margi Moulden  
Territory: W. Can.

## Colorado

**George Cofrank & Assoc., Inc.**  
2650 W. 2nd Ave., Unit 13  
Denver, CO 80219  
Phone: (303) 922-3692  
Fax: (303) 922-8873  
Salespeople: George Cofrank,  
Brad Steele  
Territory Covered: CO, UT, WY, MT,  
ID, NM, El Paso TX.

**The Florentine Co.**  
7694 W. Coal Mine Pl.  
Littleton, CO 80123  
(303) 973-4461  
FAX: (303) 973-4813  
Salespeople: Tony Florentine, Susan  
Florentine, Jennifer Florentine  
Territory: CO, UT, NM, WY

**Sweeney Associates**  
920 E. 17th Ave.  
Denver, CO 80218  
(303) 860-1882  
FAX: (303) 832-8751  
Salespeople: Mike Sweeney, Kevin  
Sausker  
Territory: CO, VT, NM, WY, ID, MT, El  
Paso, TX

## Connecticut

**Kevin Kelahe Associates**  
1317 Corbin Ave.  
P.O. Box 1928  
New Britain, CT 06050  
(203) 224-9234  
FAX: (203) 826-1103  
Salespeople: Kevin Kelahe, Jim  
Kelahe, Jim McNamee, Leslie  
Saunders, Herb Kaplow  
Territory: New England

## Florida

**Rand-Mark South, Inc.**  
P.O. Box 5283  
Ft. Lauderdale, FL 33310-5283  
(305) 484-1284  
FAX: (305) 484-6345  
Salespeople: A. Hank Stern, I. Jeff Stern  
Territory: FL, except NW corner

**Sunbelt Sales, Inc.**  
1050 Crystal Bowl CR.  
Casselberry, FL 32707  
(407) 695-6166  
FAX: (407) 695-4166  
Salespeople: Ken Lund, Stan  
Schureman, Jason Lund, Diane Lund  
Territory: FL

**Suncoast Marketing Assoc. Inc.**  
P.O. Box 14055  
Clearwater, FL 34629

Suncoast Marketing Assoc. Inc.

*Continued from page 125*

(813) 786-4513  
FAX: (813) 785-1234  
Salespeople: Mike Barret, Ed Skaalend,  
Jeff Barnett, Neal Boynton, Tom  
Melville  
Territory: FL, GA, AK, NC, SC, TN

Georgia

**Covil/Russom Associates**  
2289 Rushmore Dr.  
Marietta, GA 30062  
(404) 992-8725  
FAX: (404) 992-0776  
Salespeople: Mike Russom, Dave Covil  
Territory: GA, AL, NC, SC, VA, East  
TN

**Giles & Associates**  
4713 Hammermill Rd.  
Tucker, GA 30084  
Phone: (404) 493-8811  
Fax: (404) 491-1653  
Salespeople: Brenda Bundy,  
George Giles, Greg Baugh,  
Angela Faircloth  
Territory: GA, AL, TN

**R.E. Perkola Representatives**  
P.O. Box 779  
Buford, GA 30518  
Phone: (404) 945-7854  
Fax: (404) 271-0625  
Salespeople: Robert Perkola,  
Charles Pendleton  
Territory: GA, AL, E. TN.

**S.B.S. Associates, Inc.**  
1530 Hillcrest Rd.  
Norcross, GA 30093  
(404) 923-9227

FAX: (404) 923-9262  
Salespeople: J. W. Southard, J.  
Southard, T. Southard, Roy Brown,  
Buddy Brown, J. Phillips  
Territory: VA, NC, SC, TN, GA, AL, FL,  
MS

Illinois

**F & L Sales & Marketing**  
228 Des Plaines Ave.  
Forest Park, IL 60130  
(708) 366-6521  
FAX: (708) 366-7581  
Salesperson: Steve Floyd  
Territory: IL, IN, WI

**Grotts & Associates**  
11727 S. Brightway  
Mokena, IL 60448  
Phone: (708) 479-1324  
Fax: (708) 479-6364  
Salesperson: Tom Grotts  
Territory: IL, No. IN, SW WI.

**A.J. Hildebrand & Co.**  
137 N. Oak Park Ave., Rm. 401  
Oak Park, IL 60301  
Phone: (708) 383-2333  
Fax: (708) 383-1377  
Salespeople: Jack Hildebrand,  
Gary Hildebrand, Robert Harrison,  
Mike Robinson  
Territory: No. IL, E. WI.

**K-M Sales Inc.**  
P.O. Box 2082  
Northbrook, IL 60065  
Phone: (708) 564-1976  
Fax: (708) 564-5602  
Salespeople: David Shapiro,

Marshall Shapiro.  
Territory: IL, So. WI.

**Midwest Security Sales**  
12701 Oak Valley Trail  
Lockport, IL 60441  
(708) 301-0604  
FAX: (708) 301-8800  
Salesperson: Richard Stukus  
Territory: IL, WI, Lake Co. IN

**Robert Perry Associates, Inc.**  
509 Lunt Ave.  
Schaumburg, IL 60193  
(708) 894-1700  
FAX: (708) 894-3198  
Salespeople: Robert Perry, Mark  
Nelson  
Territory: IL, IN, WI

**Gene Simon, Hardware Specialist**  
P.O. Box 51  
Flossmoor, IL 60422  
(708) 799-8783  
FAX: (708) 799-4322  
Territory: IL, IN, MI, MN, MO, OH, WI

**Smith & Smith Sales Inc.**  
10928 S. Western Ave.  
Chicago, IL 60643  
Phone: (312) 238-5570  
Fax: (312) 881-4258  
Salespeople: Robert Smith,  
Donald Smith, Richard Smith  
Territory: IL, WI.

**Tri-Power Marketing**  
420 Appley Ave.  
Libertyville, IL 60048  
(708) 680-9460

**Major**  
MANUFACTURING, INC.

**Installation Tools**

**The Professionals Choice**

[Click here for more information](#)



### Minnesota

**Galaxy Sales Inc.**  
41 10th Ave. North  
Hopkins, MN  
(612) 935-1919  
FAX: (612) 935-9836  
Salespeople: Dave Nessa, Gary  
Clifford, Skip Schultz, Bob  
Hammermeister, Tom Nessa  
Territory: MN, SD, ND, IA, Western WI

**HMR, Inc.**  
9065 Lyndale Ave., So.  
Bloomington, MN 55420-3520  
(612) 888-2122  
FAX: (612) 884-4768  
Salespeople: Zev, Carol  
Territory: MN, ND, SD, Western WI

**Kenaco Inc.**  
12885 Gerard Dr.  
Eden Prairie, MN 55346  
(612) 944-2616  
FAX: (612) 944-2616  
Salesperson: Ken Anderson  
Territory: MN, IA, WI, ND, SD, NB

**Kodo Associates Inc.**  
400 East 79th St.  
Minneapolis, MN 55420-1253  
(612) 881-1255  
FAX: (612) 881-6893  
Salespeople: Steve Finanger, Dan  
Stelter, Sharon Goetzke, Kodo  
Kawamura  
Territory: MN, ND, SD, Western WI

**K. S. Sales**  
1023 Dwane St.  
So. St. Paul, MN 55075  
Phone: (612) 451-3504  
Fax: (612) 457-0532  
Salesperson: C.E. Garross  
Territory: MN, W-Wisc., ND,  
SD.

**M.R. Representatives**  
800 Transfer Rd., Suite 32  
St. Paul, MN 55114  
(612) 659-0801  
FAX: (612) 659-0803  
Salespeople: Ken Minehan, Mark  
Schrantz  
Territory: MN, ND, SD, Western WI

**Northern Market Representatives**  
3865 Granada Way North  
Oakdale, MN 55128  
(612) 779-7622  
FAX: (612) 779-7622  
Salespeople: George Hall, Paula Hall  
Territory: MN, ND, WI, IA, SD

### Missouri

**Bob Howard & Associates**  
P.O. Box 2155  
Ellisville, MO 63011  
Phone: (314) 391-6634  
Fax: (314) 391-2852  
Salespeople: Robert Howard,  
Kelly Howard-Bennett, Jim  
McFerren.  
Territory: MO, IA, KS, NE.

**Jerry Vinck & Associates**  
416 N. Moore St.  
Lee's Summit, MO 64081  
Phone: (816) 524-1039  
Fax: (816) 525-1315

Salespeople: Michael Vinck,  
Jerry Vinck, Thomas Vinck.  
Territory: MO, KS, IA, NE, IL.

### New Jersey

**Harris & Lobo**  
1050 Wall St. West  
Lyndhurst, NJ 07071  
(201) 935-7550  
FAX: (201) 935-8738  
Salespeople: John Zawrotnay, Wally  
Lobo, Todd Gertz, Mike Russo, Rob  
Skidmore  
Territory: NY, NJ metro area

**Herlo, Inc.**  
623 Eagle Rock Ave.  
West Orange, NJ 07052  
(201) 731-1600  
FAX: (201) 731 7340  
Salespeople: Richard Unice, Arthur  
Lefkowitz, Gilbert Wasserman, Hy  
Hoffman, Hy Mailen  
Territory: NY, NJ, Upstate NY

**Koines & Alan, Inc.**  
P.O. Box 505  
Chester, NJ 07930  
(908) 879-7720  
FAX: (908) 879-7220  
Salesperson: Arthur Koines  
Territory: NY, NJ

**Dave Mc Fadden & Associates**  
624 Holly Hill Dr.  
Brielle, NJ 08730  
Phone: (908) 528-6607  
Salesperson: Dave Mc Fadden  
Territory: 13 states.

**Paul J. Polke Co.**  
48 Oak St.  
Clifton, NJ 07014  
Phone: (201) 777-7500  
Fax: (201) 777-0820  
Territory: NJ, NY

**Triad Associates**  
2559 Algonkin Trail  
Manasquan, NJ 08736  
(908) 528-5658  
FAX: (908) 223-8396  
Salespeople: Stan Rosenthal, Dave  
Bryant, John Saladucha, William Lane  
Territory: NY, NJ, Eastern PA, MD, DC

### New York

**CG Sales Company**  
Division of Gagliano Enterprises, Inc.  
4 Poole St.  
Oceanside, NY 11572  
(516) 766-6549  
FAX: (516) 536-5368  
Salesperson: Carmen Gagliano  
Territory: Northern NJ, NY State

**Glezen Associates Inc.**  
13 Havens St.  
Elmsford, NY 10523  
Phone: (914) 592-3800  
Fax: (914) 592-3813  
Salespeople: Rich Hausler,  
Rachael Simons, Bob Wolfskehl,  
Fred York.  
Territory: NY, NJ, CT.

**Michael H. Kaye**  
444 E. 82nd St.  
New York, NY 10028

(212) 472-1573  
Territory: NY Metropolitan area

**The Landesman Group Inc.**  
222 Martling Ave.  
Tarrytown, NY 10591  
(914) 631-6282  
FAX: (914) 631-5787  
Territory: Metro NY

**The Moyer Agency**  
1848 Bennett Rd.  
Pine City, NY 14871  
(607) 732-2738  
(607) 732-7997  
Salespeople: Robert Moyer, Fran  
Johnson  
Territory: Upstate NY

**Tri-Star Sales**  
22 Tryon Ave.  
Staten Island, NY 10312  
(718) 948-6088  
FAX: (718) 966-7531  
Salespeople: Len Solomon, Bob Moyer  
Territory: NYC, Long Island,  
Westchester, No. NJ

### North Carolina

**Everett Dukes Associates Inc.**  
7517 Orr Rd.  
Charlotte, NC 28213  
(704) 596-6050  
FAX: (704) 596-6060  
Salespeople: Mickey Lawson, Anne  
Schmid, Everett Dukes Jr., Mark Dukes,  
Teresa Helms  
Territory: Carolinas, VA, East TN

**Mc Dowell Sales**  
4000 Rounding Run  
Charlotte, NC 28277  
Phone: (704) 541-0439  
Fax: (704) 541-5245  
Salesperson: George Mc Dowell  
Territory: NC.

**O'Neill Associates**  
2317 Cloister Dr.  
Charlotte, NC 28211  
(704) 366-7589  
Territory: NC, SC, GA

**Tsantes & Assoc.**  
9237 Kings Canyon Dr.  
Charlotte, NC 28210  
(704) 541-6398  
FAX: (704) 541-6397  
Territory: NC, SC, GA, FL

**Youngblood Associates Inc.**  
4400 Morris Park Dr., Suite A  
Charlotte, NC 28227  
Phone: (704) 545-4545  
Fax: (704) 545-5060  
Salespeople: Dave Youngblood,  
John Williamson  
Territory: NC, SC.

### Ohio

**Associated Hardware Agents**  
P.O. Box 247  
Wooster, OH 44691  
(216) 264-8051  
FAX: (216) 262-1628  
Salespeople: Dick Maynard, John  
Arzer, III  
Territory: Ohio, W. PA, Kentucky

**Rich Barnaby Associates**  
7792 Olentangy River Rd.  
Worthington, OH 43085  
(614) 846-0620  
FAX: (614) 846-4881  
Salespeople: Richard Barnaby, Susan  
Barnaby, Richard Kiefes, Michael  
Stevenson, M. Dan Price  
Territory: Ohio, W. PA, W. VA, IN, KY

**Barrett Group Inc.**  
6170 Centre Park Dr.  
Maineville, OH 45039  
(513) 779-9350  
FAX: (513) 779-1410  
Salespeople: Tom Barrett, Mary Barrett,  
Fritz Graf, Bruce Smythe, Stu Steck  
Territory: Ohio, KY, W. VA, W. PA

**Bockert & Associates, Inc.**  
1933 SR 61  
Norwalk, OH 44857  
(419) 663-2516  
FAX: (419) 663-1588  
Salespeople: John Bockert, Tony  
Heavrin, Bob Staten, Jeff Nill  
Territory: MI, OH, IN, KY, TN, W. VA,  
Western PA

**Burson Brothers**  
24015 Bruce Rd.  
Bay Village, OH 44140  
Phone: (216) 871-5952  
Salespeople: John Burson,  
Don Burson, Dave Burson.  
Territory: OH, W. VA.

**ECE**  
20728 Erie Rd., Suite B  
Rocky River, OH 44116

(216) 331-2868  
FAX: (216) 331-1790  
Salespeople Ernest Green, Edward  
Olbrys  
Territory: OH, W. VA, W. PA

**Lent and Associates**  
4582 San Andres Place  
Columbus, OH 43230  
(614) 476-5544  
(614) 476-5559  
Salesperson: Gene Lent  
Territory: OH, IN, KY, W. VA, W. PA

**Howard W. Murray Company**  
28901 Clemens Rd.  
Westlake, OH 44145  
(216) 835-9390  
(216) 835-3776  
Salespeople: Mike Murray, Jim Murray  
Territory: OH, MI, IN, W. PA, W. VA

**Ed O'Grady**  
P.O. Box 29213  
Columbus, OH 43229  
Phone: (614) 882-6800  
Fax: (614) 898-9094  
Salesperson: Ed O'Grady  
Territory: W. PA, KY, OH.

**The Roach Co.**  
1600 Jupiter Ave.  
Hilliard, OH 43026  
(614) 771-6006  
FAX: (614) 771-6007  
Salespeople: Bill Roach III, Peggy  
Roach  
Territory: OH, KY

**Stanley Tepper & Co. Inc.**

6405 Gates Mills Blvd.  
Cleveland, OH 44124  
(216) 461-6110  
FAX: (216) 461-1213  
Territory: OH, W. VA, W. PA

**Oklahoma**  
**Tedeo Agency, Inc.**  
1101 Enterprise Ave., Suite 3  
Oklahoma City, OK 73128  
(405) 948-1622  
Salespeople: Ted Bunga, Linda Bunga,  
Michael Quinnett  
Territory: OK, AR

**Pennsylvania**  
**AHA Inc.**  
418 Manordale Dr.  
Pittsburgh, PA 15241  
Phone: (412) 831-7877  
Territory: OH, W. VA, W. PA.

**R.L. Larrabee Mfg. Agency Inc.**  
600 Haverford Rd.  
Haverford, PA 19041  
(215) 642-0105  
FAX: (215) 642-0130  
Salespeople: Stephen Larrabee, Larry  
Larrabee, Thomas Myers, George  
Johnston  
Territory: So NJ, E. PA, DE, MD, Wash.  
DC, VA

**Mid-Atlantic Agents, Ltd.**  
14 Cambridge Rd.  
Downingtown, PA 19335  
Phone: (215) 458-0390  
Fax: (215) 458-0261  
Salespeople: Robert Cole,  
Richard Manley, Whit Summers,

**medeco**<sup>®</sup>  
HIGH SECURITY LOCKS

**The market leader  
in locking systems for security,  
safety, and control.**

[Click here for more information](#)



Mid-Atlantic Agents Ltd.

Continued from page 129

Ed Linaugh.  
Territory: NJ, PA, DE, MD, DC,  
VA.

**Palmer & Golden Sales Inc.**  
P.O. Box 572  
Havertown, PA 19083-0572  
(215) 328-4888  
Salespeople: Joel Golden, Vernon  
Wilkins  
Territory: PA, So NJ, DE, MD, DC, VA

**Sporckin Associates Inc.**  
520 Abbott Dr.  
Broomall, PA 19008  
(215) 544-6060  
FAX: (215) 544-8040  
Territory: S. NJ, E. PA, DE, MD, VA,  
Wash. DC

Texas

**Clark & Shuck Associates, Inc.**  
11311 Harry Hines, Suite 602  
Dallas, TX 75229  
(214) 247-4692  
FAX: (214) 246-3606  
Salespeople: Don Clark, Con Shuck,  
Mike Clark, Lance Reynolds, Dave  
Popovich  
Territory: TX, OK, AR, Shelby Co. LA

**Galis Enterprises, Inc.**  
P.O. Box 13334  
Arlington, TX 76094  
(817) 461-2079  
FAX: (817) 860-6999  
Salespeople: Martin Galis, Eric Klein  
Territory: TX, NM, OK, AR

**Howard Sales Co.**  
4625 Ripley Dr.  
El Paso, TX 79922  
(915) 833-7733  
FAX: (915) 833-7770  
Salesperson: Bill Uhlig  
Territory: US

**Long-Mc Michael Inc.**  
11034 Shady Trail, #110  
Dallas, TX 75229  
Phone: (214) 351-4813  
Fax: (214) 351-4903  
Salespeople: Joe Long,  
Ted Mc Michael, Mike Waltrip  
Territory: TX, OK, AR, LA.

**Security Hardware Marketing Co.**  
14580 E. Beltwood Parkway, Suite 107  
Dallas, TX 75244  
(214) 960-2002  
FAX: (214) 960-2029  
Salesperson: Tony Whitley, Sr.  
Territory: TX, OK, LA, AR, MS, KS, W.  
TN

**H. L. Simon Company**  
1314 Huntington Dr.  
Richardson, TX 75080  
(214) 234-8009  
FAX: (214) 234-0339  
Territory: TX, OK, KS, AZ, UT, CO, NM

Utah

**Nelson & Associates**  
927 E. Millstream Way  
Bountiful, UT 84010  
(801) 295-0328

FAX: (801) 295-4535  
Salesperson: Mel Nelson  
Territory: UT, CO, ID, WY, MT

Washington

**R. Dulin & Son Inc.**  
2217 Broadway  
Everett, WA 98201  
Phone: (206) 252-1200  
Fax: (206) 259-4355  
Salespeople: Gene Hedrick,  
Mary Peterson, Mike Dulin.  
Territory: OR, WA, AK, ID.

**Frank J. Martin Co.**  
8512 20th Ave. NE  
Seattle, WA 98115  
Phone: (206) 523-7665  
Fax: (206) 523-9876  
Salesperson: Marty Martin  
Territory: WA, OR, AK, ID,  
BC, Alberta

**Roger Ponto Associates, Inc.**  
12816 N.E. 125th Way  
Kirkland, WA 98034  
(206) 821-2996  
FAX: (206) 823-9827  
Territory: AK, WA, OR, ID, MT, HI

Wisconsin

**Donald A. Loss Associates Inc.**  
P.O. Box 340260  
Milwaukee, WI 53234  
Phone: (414) 384-4448  
Fax: (414) 384-5577  
Salespeople: Jeff Loss,  
Matt Loss.  
Territory: WI.

# Locksmith Associations

National

**American Lock Collectors Assn.**  
Contact: Charles Chandler  
36076 Grennada  
Livonia, MI 48154  
Phone: (313) 522-0920  
Members from: U.S.  
Number of members: 250

**American Society for Industrial  
Security**  
Contact: Susan Melnicore  
1655 N. Ft. Myer Dr., #1200  
Arlington, VA 22209  
Phone: (703) 522-5800  
Fax: (703) 243-4954  
Members from: Internationally  
Number of members: 24,000  
Trade Show: 38th Annual  
Seminar & Exhibit, 9/14/92  
to 9/17/92.

**ASSOC. LOCKSMITHS OF  
AMER.**

(ALOA)  
3003 Live Oak St.  
Dallas, TX 75204  
Phone: (214) 827-1701  
Fax: (214) 827-1810  
See ad on page 78

**Builders Hardware Manufacturers  
Assn.**  
Contact: Peter Rush  
355 Lexington Ave.  
New York, NY 10017  
Phone: (212) 661-4261  
Fax: (212) 370-9047  
Members from: worldwide  
Number of members: 80  
Meetings: Annual Mfg.  
October, Spring Mfg. April.

**The Door & Hardware Institute**  
Contact: Richard M. Hornaday  
14170 Newbrook Dr.  
Chantilly, VA 22021-2223  
Phone: (703) 222-2010

Fax: (703) 222-2410  
Members from: Door & Arch.  
Hardware Commercial Security  
Number of members: 6,000  
Meetings: once a year  
Trade Show: Door & Hardware  
Inst. Annual Convention, 10/17/92  
to 10/20/92.

**Institutional Locksmiths' Assn.**  
Contact: Peter G. Femino, Jr.  
P.O. Box 4097  
Dedham, MA 02026-0902  
Phone: (617) 577-5409  
Fax: (617) 577-5343  
Members from: Internationally  
Number of Members: 200+  
Meetings: Varied

**Lock Museum of America**  
Contact: Thomas Hennessy  
P.O. Box 104  
130 Main St.  
Terryville, CT 06786

Phone: (203) 589-6359  
Members from: Worldwide  
Number of members: 600  
Meetings: 1st Friday of the month.

**National Burglar & Fire Alarm Assn.**

Contact: Melody Magnas  
7101 Wisconsin Ave.  
Suite 1390  
Bethesda, MD 20814-4805  
Phone: (301) 907-3202  
Fax: (301) 907-7897  
Members from: nationwide  
Number of members: 2600  
Meetings: Quarterly  
Trade Show: Arizona Burglar & Fire Alarm Assn., conv. 6/3/92 to 6/7/92, show 6/5/92 to 6/6/92.

**National Locksmith Suppliers Assn.**

Contact: Patricia A. Lilly  
1900 Arch St.  
Philadelphia, PA 19103  
Phone: (215) 564-3484  
Fax: (215) 564-2175  
Members from: U.S., Canada  
Number of members: 150  
Meetings: April, May

**Security Industry Assn.**

Contact: Michael D. Lane  
1255 23rd St. NW  
Suite 850  
Washington, DC 20037  
Phone: (202) 466-7420  
Fax: (202) 833-3636  
Members from: Nationwide  
Number of members: 213  
Meetings: 3-4 times a year.  
Trade Show: Int'l. Security Conference & Expo, East 9/25/92 to 9/27/92, West 2/11/92 to 2/23/92, Facilities Security & Protection, 2/24/92 to 2/27/92.

**Safe & Vault Technicians Association**

5083 Danville Rd.  
Nicholasville, KY 40356  
(606) 885-3916  
Fax: (606) 885-7093

**Alabama**

**Heart of Dixie Chapter, ALOA**

Contact: Dallas Brooks  
P.O. Box 2022  
Decatur, AL 35602  
Phone: (205) 826-8990  
Members from: AL  
Number of members: 67  
Meetings: Quarterly

**Arizona**

**Grand Canyon Chapter, ALOA**

Contact: Leon Burge  
850 E. 24th St.  
Yuma, AZ 85365  
Phone: (602) 726-8643

**Professional Associated Locksmiths of Arizona**

Contact: Bill Campbell  
29 W. Thomas Rd., Suite A  
Phoenix, AZ 85013  
Phone: (602) 263-9777  
Fax: (602) 264-4122  
Members from: AZ  
Number of members: 75

Meetings: Second Tuesday of the month except December  
Trade Show: Southwest Seminar IV and Security Trade Show, September 1992

**California**

**San Diego Chapter, ALOA**

Contact: Stephen L. Wilson  
P.O. Box 261486  
San Diego, CA 92196  
Phone: (619) 695-8956  
Members from: San Diego County  
Number of members: 60+  
Meetings: 3rd Tuesday, odd months.

**California Assn. of Lock & Security Equipment Contractors**

Contact: Wayne D. Maris  
1112 I Street, #110  
Sacramento, CA 95814  
Phone: (916) 446-2726  
Fax: (916) 448-1507  
Members from: CA  
Number of members: 100+  
Meetings: 4 x year, Last Sunday of the month.

**L.A./Orange Counties Chapter, ALOA**

Contact: Wynn Kessler  
4009 Layman Ave.  
Pico Rivera, CA 90660  
Phone: (213) 692-6063

**Canada**

**Association of Ontario Locksmiths**  
2220 Midland Ave., Unit 106  
Scarborough, Ont. Canada M1P 3E6  
Phone: (416) 321-2219

**British Columbia Locksmith Assn.**

Contact: George Hawkes  
Box 1517 Qualicum Beach  
B.C., Canada V0R 2T0  
Phone: (604) 752-1312  
Fax: (604) 752-1312  
Members from: British Columbia  
Canada  
Number of members: 100  
Meetings: Monthly  
Trade Show: Northwest Tri-Regional and Annual Convention, 1992

**Professional Locksmith Assn. of Alberta**

Contact: Wayne McMillan  
Box 4744  
Edmonton, AB Canada T6E 5G6  
Phone: (403) 465-5083  
Members from: AB, Sask, NWT, BC  
Numbers of members: 320  
Trade Show: PLAA Convention 92, 10/16/92 to 10/20/92.

**Colorado**

**Colorado Front Range, ALOA**

Contact: Earl Mitchell  
7780 W. 88th Ave.  
Arvada, CO 80005  
(303) 424-3976

**Rocky Mountain Locksmiths' Assn.**

Contact: Kent A. Smith  
4690 E. Colfax Ave.

Denver, CO 80220-1202  
Phone: (303) 321-0891  
Fax: (303) 320-0891  
Members from: Rocky Mountain Region  
Number of members: 115  
Meetings: 1st Tuesday of the month.

**Western Slope Locksmiths' Association**

306 N. 12th St.  
Gunnison, CO 81230  
Phone: (303) 641-3940

**Connecticut**

**Locksmith Association of Connecticut**

555 New Park Ave.  
West Hartford, CT 06110  
Phone: (203) 236-1680

**District of Columbia**

**Locksmiths Assn. of Washington DC Area, Inc.**

Contact: John D. Cannon  
7014 Bedrock Rd.  
Alexandria, VA 22306  
Phone: (703) 960-6413  
Fax: (703) 768-1291  
Members from: VA, MD, Dist. of Columbia  
Number of members: 600+  
Meetings: 4th Thursday of the month.

**Florida**

**Central Florida Locksmiths Assn.**

Contact: Robert F. Jarvis, JR.  
91 N. Causeway  
New Smyrna Beach, FL 32169  
Phone: (904) 428-7233  
Members from: FL  
Meetings: 3rd Wednesday of the month.  
Trade Show: S.E.R.L.A.C., September 1992.

**First Coast Locksmiths Assn.**

Contact: William L. Hokanson  
P.O. Box 26637  
Jacksonville, FL 32218  
Phone: (904) 743-0178  
Fax: (912) 673-3784  
Members from: FL, GA  
Number of members: 75  
Meetings: 2nd Thursday of the month.  
Trade Show: FCLA Annual Swap Meet, April

**Florida-Alabama Locksmith Assn.**

Contact: Larry D. Kiepe  
6 Comet St., SW  
Ft. Walton Beach, FL 32548  
Phone: (904) 243-6918  
Members from: No. FL, So. AL  
Number of members: 35  
Meetings: Quarterly  
Trade Show: SERLAC, 9/9/92 to 9/13/92.

**Florida East Coast, ALOA**

Contact: William Watkinson  
P.O. Box 060238  
Palm Bay, FL 32906  
Phone: (407) 729-9598

**Florida West Coast Locksmith Assoc.**

3245 Bay to Bay Blvd.



Florida West Coast Locksmith Assn.

Continued from page 131

Tampa, FL 33629  
(813) 837-2898

**South Florida Chapter, ALOA**  
Contact: Donald Barraclough  
6414 Pembroke Rd.  
Miramar, FL 33023  
Phone: (305) 962-8160

**South Florida Locksmith Assn.**  
Contact: Wayne Gurnee  
P.O. Box 14322  
Ft. Lauderdale, FL 33302  
Phone: (305) 251-1247  
Fax: (305) 565-3786  
Members from: Dade, Broward,  
Palm Beach, Monroe County  
Number of members: 150+  
Meetings: 3rd Thursday of the  
month.  
Trade Show: SERLAC, 9/9/92 to  
9/13/92.

**State of Florida Board  
of Locksmiths, Inc.**  
Contact: Carl M. Mauldin, Jr.  
Rt. 2, Box 103W - Bayou Rd.  
Freeport, FL 32439-9609  
Phone: (904) 267-2612  
Members from: FL  
Number of members: 98  
Meetings: November, February,  
May.  
Trade Show: Lockfest 92, 5/23/92  
to 5/25/92.

**Georgia**  
**Dixie Locksmith Assn.**  
Contact: Sara Smith  
129 Sunset Lane  
Albany, GA 31705  
Phone: (912) 888-7233  
Members from: GA, TN, AL, FL, VA  
Number of members: 123  
Meetings: 1st Saturday of  
even months.  
Trade Show: SERLAC, 9/5/92  
to 9/13/92.

**Georgia Chapter, ALOA**  
Contact: Danny W. Rudd  
P.O. Box 83  
Morrow, GA 30260-0083  
Phone: (404) 961-4474  
Members from: GA  
Number of members: 219  
Meetings: 3rd Saturday of  
odd months.

**Hawaii**  
**Hawaii Chapter, ALOA**  
Contact: Thomas Carrion  
91-919 Ft. Weaver Rd., #113  
Ewa Beach, HI 96706  
Phone: (808) 235-2987

**Illinois**  
**Illinois Locksmiths Association**  
Contact: Joseph Stevens  
Phone: (618) 295-3415  
Meetings: 1st Sunday of each month

**Greater Chicago Locksmiths Assoc.**  
6124 N. Milwaukee Ave., Suite 11  
Chicago, IL 60646  
Phone: (312) 631-2970  
Meetings: 1st Wednesday of each  
month.

**Northern Illinois, ALOA**  
Contact: John Proctor  
P.O. Box 160  
Grayslake, IL 60030  
Phone: (708) 223-1077

**Indiana**  
**Associated Locksmiths  
of Indiana**  
P.O. Box 2714  
Indianapolis, IN 46206  
Members from: IN  
Number of members: 60+  
Meetings: 3rd Wednesday of the  
month.

**Central States Locksmith  
Assn.**  
Contact: David Kerr  
219 E. Cottom Ave.  
New Albany, IN 47150  
Phone: (502) 244-7077  
Fax: (502) 244-7076  
Members from: No. KY, So. IN  
Number of members: 25  
Meetings: 3rd Wednesday of the  
month.

**Northern Indiana Chapter, ALOA**  
Contact: Larry L. Votaw  
P.O. Box 10  
Pleasant Lake, IN 46779  
Phone: (219) 665-2127  
Members from: No. IN, So. MI,  
NW OH.  
Number of members: 23  
Meetings: 2nd Sunday of the  
month.

**Southern Indiana Chapter, ALOA**  
Contact: L.E. Jurras  
P.O. Box 680  
908 W. Main St.  
Washington, IN 47501  
Phone: (812) 254-7698  
Members from: Southwestern  
Central Indiana  
Number of members: 20  
Meetings: 3rd Sunday of the  
month.

**Iowa**  
**Iowa Locksmith Assn.**  
Contact: Kenneth Novoy  
125 School St.  
Marion, IA 52302  
Phone: (319) 377-4295  
Members from: IA  
Number of members: 75  
Meetings: Every other month.  
Trade Show: MINK, 1992

**Kansas**  
**Great Plains Locksmith Assn.**  
Contact: Lonnie McKinney  
P.O. Box 2484  
Salina, KS 67402  
Phone: (913) 825-6257  
Fax: (913) 825-8889  
Members from: KS  
Number of members: 34  
Meetings: Bi-monthly.

**Kansas Chapter, ALOA**  
Contact: Lonnie McKinney  
P.O. Box 2484  
Salina, KS 67402  
Phone: (913) 825-6257  
Fax: (913) 825-8889

Members from: KS  
Number of members: 28

**Kentucky**  
**Central States Locksmith Association**  
Contact: David Kerr  
219 E. Cottom Ave.  
New Albany, IN 47150  
Phone: (812) 948-0569, (502) 244-7077  
Members from: IN, KY  
Meetings: 3rd Wednesday of the  
month.

**Kyana Chapter, ALOA**  
Contact: Ken Schwedler  
206 N. 4th St.  
LaGrange, KY 40031  
Phone: (502) 222-1955

**Louisiana**  
**Ark-La-Tex Locksmiths Assn.**  
Contact: Debbie Motschman  
1387 Airline Dr.  
Bossier City, LA 71112  
Phone: (318) 227-9458  
Members from: LA, TX, AR  
Number of members: 65  
Meetings: 2nd Tuesday, every  
other month.

**Louisiana-Mississippi Locksmith  
Assn.**  
Contact: Peggy Benfer  
P.O. Box 643  
Meridian, MS 39302

**Maine**  
**Pine Tree State Locksmith Association**  
Contact: James Thibodeau  
RFD 4, Box 79  
Ellsworth, ME 04605  
Phone: (207) 667-5369

**Maryland**  
**Maryland Locksmiths Assn.**  
Contact: Stephen J. Brown  
2 Mellor Ave.  
Baltimore, MD 21228  
Phone: (410) 747-5625  
Fax: (410) 744-3212  
Members from: MD, DC, VA, DE, PA  
Number of members: 30+  
Meetings: 3rd Tuesday of the  
month.

**Massachussets**  
**Massachusetts Chapter, ALOA**  
Contact: Stephen Erlich  
200 Weir St.  
Taunton, MA 02780  
Phone: (508) 823-4649  
Fax: (508) 880-6385  
Number of members: 53  
Meetings: 2nd Monday of September,  
December, March, June.

**Massachusetts Locksmiths Assn. Inc.**  
Contact: Mario Litari  
P.O. Box 2384  
Woburn, MA 01888  
Phone: (617) 893-2117  
Members from: Springfield  
MA to Cape Cod  
Number of members: 260  
Meetings: 2nd Wednesday &  
3rd Wednesday  
Trade Show: Massachusetts  
Locksmiths Assn. Mini Show,  
4/8/92.

Massachusetts Locksmiths  
Association, Central Group  
P.O. Box 262  
Worcester, MA 01613  
Phone: (508) 757-1434

### Michigan

Locksmith Security Assn.  
Contact: Salvatore Dulcamaro  
19559 14 Mile Rd.  
Fraser, MI 48026  
Phone: (313) 791-5416  
Members from: MI  
Number of members: 100  
Meetings: 1st Thursday of the  
month.

Southeast Michigan, ALOA  
Contact: George Guffey, Jr.  
5504 Schaefer  
Dearborn, MI 48126  
Phone: (313) 581-8440

### Minnesota

Minnesota Chapter, ALOA  
Contact: David Dalby  
14251 Fisher Ave. NE  
Prior Lake, MN 55372  
Phone: (612) 894-1700  
Fax: (612) 894-1850  
Number of members: 75  
Meetings: 1st Wednesday of the  
month.

### Mississippi

Mississippi Chapter, ALOA  
Contact: William Heard  
P.O. Box 1289  
Meridian, MS 39302  
Phone: (601) 482-8525

### Missouri

Gateway Locksmith Association  
P.O. Box 15758  
St. Louis, MO 63163  
Phone: (314) 832-1214

Missouri-Kansas Locksmith Assoc.  
Contact: Ron Barron  
2405 SW Duncan Dr.  
Topeka, KS 66614  
Phone: (913) 271-5212

### Montana

Montana Chapter, ALOA  
Contact: Dale Crosby  
1900 3rd St. NW  
Great Falls, MT 59404  
Phone: (406) 452-0139  
Fax: (406) 452-0139  
Members from: MT, Su. AB  
Number of members: 27  
Meetings: 4 times a year.  
Trade Show: Spring Meet of  
Montana Locksmith, April 1992.

Montana Locksmith Assn.  
Contact: Ella Gaffaney  
130 East 6th Ave.  
Helena, MT 59601  
Phone: (406) 442-2350  
Members from: MT, ID, WY,  
Canada  
Number of members: 34  
Meetings: semi annually  
Trade Show: M.L.A. Annual  
Convention, 4/24/92 to  
10/26/92.

### Nebraska

Nebraska Chapter, ALOA  
Contact: Keith Delano  
P.O. Box 145  
McCook, NE 69001  
Phone: (308) 345-6174

Nebraska Locksmiths Association  
Contact: Elvis Hammersmit  
706 Allen  
Hayes, KS 67601  
Phone: (913) 625-3969  
Convention: Educational Weekend,  
Last week of March 1992

### Nevada

Sierra Nevada Chapter, ALOA  
Contact: Dean Yount  
P.O. Box 5387

Sparks, NV 89432-5382  
Phone: (702) 329-6059  
Members from: 200 mile  
radius from Reno  
Number of members: 200  
Meetings: 3rd Tuesday of the  
month.  
Trade Show: Rendezvous,  
November 1992.

### New Hampshire

New Hampshire Locksmiths Assn.  
Contact: Robert Wyman, II  
315 Sherwood Glen  
Sommersworth, NH 03878  
Phone: (603) 693-3694  
Members from: NH  
Number of members: 40

**NATIONAL**  
**AUTO LOCK SERVICE, INC.**

***National Auto Lock Service, Inc.  
offers a wide range of equipment  
and services for the Automotive  
Locksmith. From tools and hard to  
find key blanks to transponder  
programming, we can take the  
mystery out of car service. We  
accept credit card orders, and  
can ship COD. Contact us for the  
latest in automotive technology.***

[www.laserkey.com](http://www.laserkey.com)



### New Jersey

#### **Master Locksmith Association of New Jersey**

P.O. Box 2441  
Morristown, NJ 07962  
Phone: (201) 538-1588  
Trade Show: MLANJ Show, March 5 to 9, 1992

#### **New Jersey Locksmiths' Assn.**

Contact: Ray Favocci, Jr.  
P.O. Box 941  
Piscataway, NJ 08854  
Phone: (908) 780-1558  
Fax: (908) 780-1553  
Members from: NJ  
Meetings: 2nd Wednesday of the month, September thru June.

#### **South Jersey Locksmith Assn.**

Contact: Richard Hess  
108 White Horse Rd.  
Voorhees, NJ 08043  
Phone: (609) 772-5840  
Members from: So. NJ  
Number of members: 75  
Meetings: 4th Tuesday of the month.

### New Mexico

#### **New Mexico Chapter, ALOA**

Contact: William Fadgen  
4200 Wyoming Blvd. NE  
Albuquerque, NM 87111  
Phone: (505) 293-6555

#### **New Mexico Locksmiths Assn.**

Contact: W.A. Fadgen  
4200 Wyoming Blvd., NE  
Albuquerque, NM 87111  
Phone: (505) 293-6555  
Fax: (505) 292-1215  
Members from: NM  
Number of members: 170  
Meetings: Central Chapter, 2nd Saturday of the month, SE Chapter & So. Chapter, Quarterly.  
Trade Show: NMLA, August 1992.

### New York

#### **Adirondack Hudson Master Locksmiths Association**

351 Central Ave.  
Albany, NY 12206  
Phone: (518) 462-5467

#### **Central New York Locksmiths Assn.**

Contact: Don Rapp  
467 Burnet Ave.  
Syracuse, NY 13203  
Phone: (315) 472-6988  
Fax: (315) 472-0958  
Members from: 75 mile radius from Syracuse  
Meetings: 3rd Sunday of the month.

#### **Nassau Suffolk Master Locksmith Assn. Inc.**

Contact: Gregory Scala  
71 A Merrick Rd.  
Amityville, NY 11701  
Phone: (516) 691-5837  
Members from: Nassau County & Suffolk County  
Number of members: 92  
Meetings: Last Tuesday of the

month.

#### **New York Locksmiths Association**

Contact: Brian Star  
1558 Second Ave.  
New York, NY 10028  
Phone: (212) 535-2289

### North Carolina

#### **North Carolina Locksmith Assn. Inc.**

Contact: Kathy Stewart  
809 Wicker St.  
Burlington, NC 27217  
Phone: (919) 227-7559  
Members from: NC, SC, VA, FL, OH, AL  
Number of members: 300  
Meetings: Quarterly  
Trade Show: North Carolina Locksmith Assn. 2/22/92.

### North Dakota

#### **North Dakota Chapter, ALOA**

Contact: Todd Ladwig  
1102 Main Ave.  
Fargo, ND 58103  
Phone: (701) 232-9440  
Fax: (701) 232-9446  
Members from: ND, NW MN  
Number of members: 16  
Meetings: Quarterly.

#### **Northern Prairie Locksmith Assoc.**

83 S. Terrace  
Fargo, ND 58102  
Phone: (701) 232-8579

### Ohio

#### **Ohio Valley Chapter, ALOA**

Contact: Thomas R. Smith  
705 W. Sandusky Ave.  
Bellefontaine, OH 43311  
Phone: (513) 593-9596  
Members from: OH, KY, IN  
Number of members: 35-40  
Meetings: 1st Wednesday of the month.

### Oklahoma

#### **Oklahoma Master Locksmith Assoc.**

304 S. Lynn Riggs Rd.  
Claremore, OK 74107  
Phone: (918) 341-1077

### Pennsylvania

#### **Greater Philadelphia Locksmith Association**

P.O. Box 11101  
Philadelphia, PA 19136

#### **Keystone State Chapter, ALOA**

Contact: Barry K. Leas  
P.O. Box 261  
Eagleview, PA 19408-0261  
Phone: (215) 539-9292  
Fax: (215) 539-4418  
Members from: PA  
Number of members: 40  
Meetings: 3rd Tuesday of the month.

#### **Penn-Ohio Locksmiths' Association**

307 Locust St.  
Perrysburg, OH 43551  
Phone: (419) 874-2717

#### **Western Pennsylvania Locksmith Assn.**

Contact: Leo S. Firanski  
1009 4th Ave.

Coraopolis, PA 15108  
Phone: (412) 262-5625  
Members from: W. PA  
Number of members: 75  
Meetings: 1st Wednesday of the month.

### South Carolina

#### **South Carolina Locksmith Association**

P.O. Box 425  
Easley, SC 29641  
Phone: (803) 859-2649

### Tennessee

#### **East Tennessee Locksmiths Association**

201 W. Main St.  
Johnson City, TN 37604  
Phone: (615) 928-0926

#### **Smokey Mountain, ALOA**

Contact: Marian Hutchison  
P.O. Box 3398  
Knoxville, TN 37917  
Phone: (615) 522-0841

#### **Tri-State Locksmith Association**

P.O. Box 171241  
Memphis, TN 38187  
Phone: (901) 365-4365  
Members from: TN, MS, AR

#### **West Tennessee Chapter, ALOA**

Contact: Pat Walker  
1643 Bartlett Rd.  
Memphis, TN 38134  
Phone: (901) 372-7464  
Fax: (901) 372-7464  
Members from: W. TN, E.A.R, No. MS  
Number of members: 30  
Meetings: 2nd Thursday of the month.

### Texas

#### **Greater Dallas Locksmith Association**

Contact: Hans Johnson Co.  
8901 Chancellor Row, Dallas TX 75247  
Phone: (214) 631-1566

#### **Greater Houston Locksmiths Assoc.**

Contact: Paul Cheatham  
1100 Blackhawk  
Houston, TX 77079  
Phone: (713) 493-4855

#### **Locksmith Association of San Antonio**

Contact: Dee Bucha  
518 Junction Highway  
Kerrville, TX 78028  
(512) 896-6133

#### **Northeast Texas Chapter, ALOA**

Contact: Pamela L. Albright  
1106 S. Main, Suite 3  
Duncanville, TX 75137  
Phone: (214) 296-6602  
Fax: (214) 296-6785  
Members from: Northeast TX  
Number of members: 220  
Meetings: 1st Tuesday of the month.

#### **Sunbelt Chapter, ALOA**

Contact: James W. McElwee  
1420 East 2nd

*Continued on page 136*

Sunbelt Chapter, ALOA

Continued from page 134

Odessa, TX 79761  
Phone: (915) 335-0072  
Members from: SW. TX, SE. NM  
Number of members: 30  
Meetings: 1st Saturday of  
every quarter.

**Texas Locksmith Association**  
Contact: Paul Newell  
8414 Silver Star  
San Antonio, TX 78218  
Phone: (512) 646-6918

Vermont

**Green Mountain Locksmiths  
Assn. Inc.**  
Contact: D.A. Keenan  
P.O. Box 246  
Essex, VT 05451  
Phone: (802) 878-4694  
Members from: VT  
Number of members: 40  
Meetings: every other  
month.

Washington

**Northwest Locksmith Assn.**  
Contact: Jeanne Lodge  
238 S. Wenatchee Ave.  
Wenatchee, WA 98801  
Phone: (509) 663-5610  
Fax: (509) 662-8652  
Members from: NW. WA  
Number of members: 350  
Meetings: 3rd Tuesday after  
the 2nd Wednesday  
Trade Show: NW Tri Regional  
Locksmith Conference,  
10/20/92 to 10/25/92.

West Virginia

**West Virginia Tri-State  
Area Locksmith Assn. Inc.**  
Contact: Roger A. Casey  
2846 Overlook Dr.  
Huntington, WV 25705  
Phone: (304) 522-2499  
Members from: Tri-State  
Area, KY, OH, WV  
Meetings: As called.

Wisconsin

**Wisconsin Locksmith Association**  
Contact: Frank Pranghoefer  
811 Milwaukee Ave.  
S. Milwaukee, WI 53172  
(414) 762-6560

Wyoming

**Wyoming Locksmith Association**  
413 Randall Ave.  
Cheyenne, WY 82001  
Phone: (307) 634-2915

**Wyoming Locksmith  
Assn., ALOA**

Contact: Allen McCumber  
1026 Alger Ave.  
Cody, WY 82414  
Phone: (307) 587-3035  
Members from: WY, NE, SD,  
CO, MT  
Number of members: 45  
Meetings: Every 3rd quarter.



Make Sargent  
& Greenleaf's  
Comptronic  
locks your  
choice for  
electronic  
safe locking  
solutions.

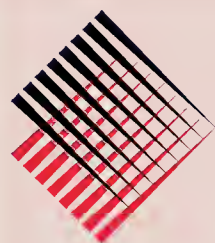

**STRATTEC™**

*It's your  
reputation.*

*Trust the  
original.*

[Click here for more information](#)

[Click here for more information](#)



## Corbin-Russwin Uniloc

"The Uniloc has long been one of the heaviest of heavy duty locks, and the recently introduced model is even heftier at nine pounds."



Send your lock and key questions to Jack Roberts, The National Locksmith, 1533 Burgundy Parkway, Streamwood, IL 60107.

by Jack Roberts

Many of today's progressive hardware stores, in an effort to broaden their scope of service, are training personnel in basic locksmithing such as picking locks, rekeying cylinders, simple installations, and even master keying. We are all aware of discount store prices which are, in many cases, lower than the prices we receive from our distributors for the same American-made products, and the influx of imported products has brought prices even lower.

These products and services are targeted to the home consumer market, the very market in which many of us had our own start and still derive a large portion of our income. It is difficult to compete in this type of market and show a reasonable profit and is just reason for us to expand our own horizons to bigger and better things that will produce more income and higher profits for our efforts.

It is advisable to learn more high security and/or electronic locking systems in an effort to replace income which may be lost due to the competition for our bread and butter. These suggestions are well taken but I will include here that many opportunities also exist for heavy duty lockset service and installations. New commercial, industrial and institutional structures as well as remodeling of existing facilities has, due to many new regulations, increased the demand for heavy duty hardware which requires increased training for service.

Most new construction installations are performed by or under the control of a general contractor, but service after the structure is accepted by the owner is

wide open for the aggressive locksmith. Many times, even with the most careful planning by architects and system designers, the traffic flow does not meet the actual requirements of occupancy. Changes are inevitable and our services can meet management requirements, if management is aware of our capabilities, and, if we are capable of performing the type service we are offering.

Remodeling existing structures and upgrading existing hardware to meet the requirements of numerous governmental agencies and regulations offers an opportunity for us to sell, install and service heavy-duty, high security and/or electronic systems, but, we must prepare ourselves by constantly upgrading our knowledge and skills.

The Corbin-Russwin Uniloc has long been one of the heaviest of the heavy duty locksets and the recently introduced 912R, *Moderalev*, (see photograph 1) is even heftier at 9 plus pounds. (Note that the body jacket has been removed for clarity.) With a redesigned lever handle, featuring inswept ends and a more comfortable gripping surface, the *Moderalev* meets all regulatory requirements and is built to provide long trouble free service.

Mechanically, the 912R has the same design and functions found on previous Uniloc models and if you are familiar with those models you will have no

problem with the *Moderalev*.

All Uniloc installations require a cut-out in the edge of the door rather than a bored hole as normally used for tubular locksets. The unit slips into the cut-out and is held in place by three through-bolts which clamp the inner and outer escutcheon plates to the door. Removal of the unit for service is rather straightforward; simply remove the through-bolts and the unit is in your hands. Service beyond that gets a little tougher.

Getting the cylinder in your hands can be a chore and the time involved must be considered when making a quote. Following is a step-by-step disassembly process:

First, the inside handle must be removed. Uniloc handles and knobs are secured to the lock body by a key which fits into a slot in the spindle and rests in a similar slot in the spindle tube. A spring retainer ring holds the key in place on knob sets and is moved out of position with the tip of a small screwdriver.

On lever handle locksets the key is retained by the lever stop which must be moved, against spring pressure, to gain access to the key. The tip of a small screwdriver can be wedged between the lock body and the lever stop and the key removed with an ice pick or similar tool. (See photograph 2.) The retaining key and its relative position in the spindle can be seen in photograph three.

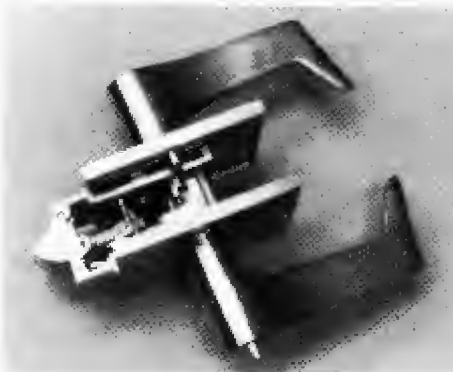

1. The Corbin-Russwin *Moderalev*.



2. Key removal.





3. The key retaining ring is visible here.

The lever handle can now be removed very carefully from the lock body, with a slight pull. The handle will move 180 degrees from its operating position as it is removed from the spindle tube. The handle return spring is strong and can cause the handle to give you a good slap on the wrist as spring tension is released. The lever handle, return spring, lever stop and retaining key are shown in photograph four. Set these parts aside and remove the exterior escutcheon plate holding screw. (See photograph 5.)

The outside lever can now be removed in the same manner as described for the inside lever. With the outside lever in hand the lever return spring must now be removed. *Do not* use excessive force in removing this spring. It will come out! A slight turn in

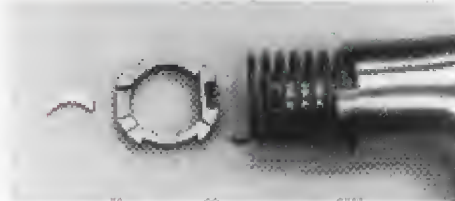

4. The lever handle, return spring, lever stop and retaining key.

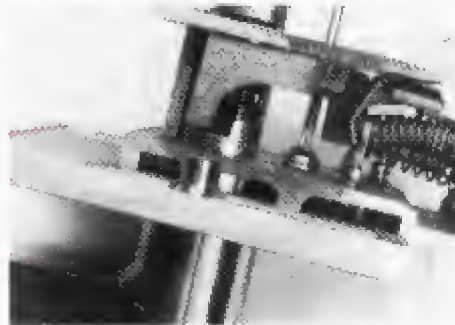

5. Removal of the escutcheon plate screw.

the opposite direction from compression, about 3/16", will line up the long hook of the spring with a slot in the lever shank and a gentle pull will get that rascal out of there.

You may be lucky and it will come right out, you may not be lucky and you will have to persuade it a bit, but not much. Any distortion of this spring and you will have some difficulty when you start to replace it and major problems the next time that it has to be removed.

There is a slot in the lever shank and the tip of a small screwdriver can be placed under the last visible winding to help get it started moving, just don't pull and yank. We have serviced Uniloc lever locks where it was apparent that the previous servicemen had absolutely no knowledge of the unit and springs were distorted to the point of being almost impossible to remove.

If we are aware of previous service we add 15 minutes to our estimate of charges for service. If we don't need it, we don't charge for it but it is much better to add the extra time that may be involved in the up front estimate.

With the return spring removed it is now necessary to remove a Waldes retainer ring which is located deep within the limited confines of the lever handle. We have tried making our own Waldes Truearc plier, but believe me, it is much better to spend the dollars for a tool that has been shaped and ground to do this job. (See photograph 6.) The

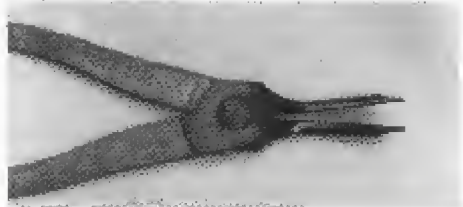

6. Waldes Truearc plier.

**SRI**  
SECURITY  
RESOURCES INC.

SRI and Steve Young are working together to bring you the best in locksmith tools and supplies.

[Click here for more information](#)



tool is about \$50.00 and is well worth the cost in time saved when servicing these units. Looking into the handle you will see the ring and note that the open ends straddle the return spring slot.

Insert the Waldes tool, (see photograph 7), grip the ring ends, and lift the ring from the handle. Note that this ring, like those used on Uniloc knob sets, has a flat side and a beveled side. When reinstalling, the flat side goes down. If you put it in the wrong way the unit may operate for a day or two but you will get a call that the lever came off in someone's hand. Do it right the first time!

When the Waldes ring has been removed, the lever shank, or spindle, will lift out of the lever housing exposing the cylinder. Using a pair of short nose pliers, remove the cylinder retainer with a slight tug. The cylinder can now be removed and serviced as required. (See photograph 8.)

Reassembly is just the reverse of disassembly. Take it slowly, step-by-step, and everything will gradually fall into place. Place the cylinder in position inside the handle and then insert the lever shank. The shank will only fit one way and the cut-out in the end must line up with the cut-out inside the handle.

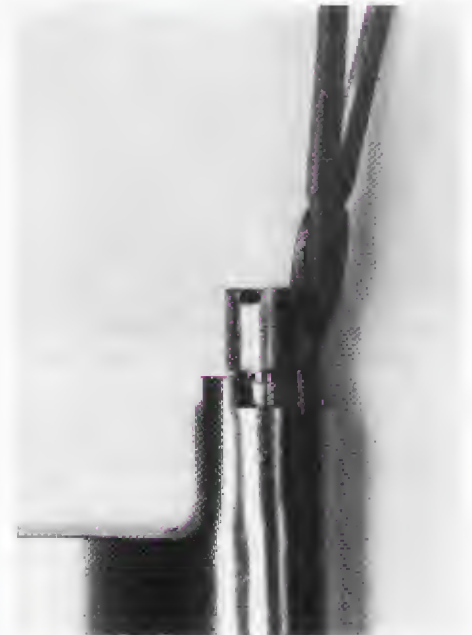

7. Removing the Waldes retainer ring.

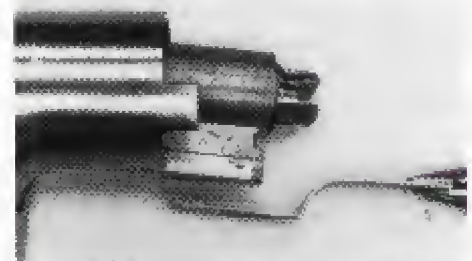

8. Removal of the cylinder retainer and cylinder.

This is where the long hook of the return spring goes.

Next, install the Waldes retainer ring, flat side down making sure that the ring is properly seated in its groove and that the open ends of the ring straddle the spring cut-out. Although this step is out of sequence, we usually make sure that the ring is seated before reinstalling the cylinder retainer. There is a slot in the spindle where the cylinder retainer fits and you can see the Waldes ring slot to insure that the ring is indeed in place. Be sure to install the cylinder retainer at this point. It can be rather exasperating to get the entire unit assembled and then notice this one part laying off to one side.

Next, the lever return spring is inserted into the handle with the long hook first. The hook fits into the slot and a slight twist in the direction of compression will seat it in place. Put the exterior escutcheon plate on the handle, place the lever stop on the short hook of the spring and slide everything onto the spindle hub of the lock body. (See photograph 9.) (The escutcheon plate is not shown in this photograph to allow for a better view of the spring and lever stop.)

Now with the handle 180 degrees



## **ASP - Your Auto Service Center for the World**

[Click here for more information](#)



9. Everything slid onto the spindle hub. out of operating position (see photograph 10), push the assembly onto the hub while turning the handle in the direction of spring compression. When it is in the right place it will slide into its proper operating position. Move

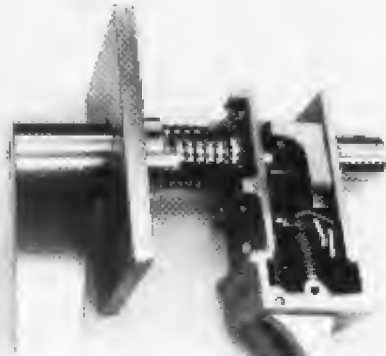

10. Assembly shown with the handle 180 degrees out of operating position.

the lever stop back with the tip of a small driver and replace the spindle retainer. A tweezer or small magnet and deft manipulation will get the retainer in place. It must be seated in the slot before the lever stop will move into position. Operation of the lever should now retract the latch. Install the inside lever in the same manner, starting with the lever 180 degrees out of synch.

Now, a few words about the lever return springs. Note in photograph 11 that there is a short hook on one end and a long hook on the other end. The long hook goes inside the lever body and the short hook goes in the lever stop. These springs are made right and left hand are not interchangeable. Always keep the spring with its lever handle. The relative position of each handle and spring is seen in photograph 12.

Study illustration 13 to get a better idea of the interior of the lever hub with the Waldes ring and return spring installed. Go

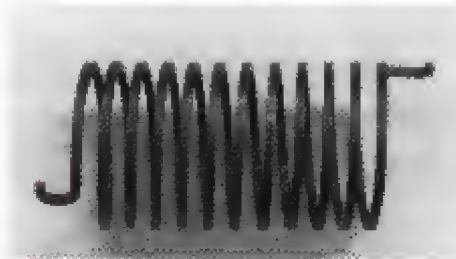

11. Lever return spring.



12. Proper positioning of handles and springs.

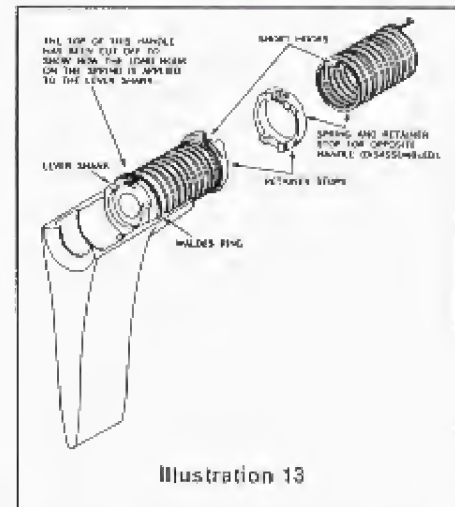

for some heavy-duty jobs, but make sure you know what you are doing and how to price your services.

Thanks to Corbin & Russwin Architectural Hardware for line drawings and technical assistance in the preparation of this article. §



**SCHWAB CORP.**

*Fire protection for your vital records.*

It's not safe unless  
it's Schwab Safe.

[Click here for more information](#)





# U.S. Security Safe

"On the newer door there is a removable cover which lets you service all the lock parts. In the older door service is more complicated."



by Dale Libby

The U.S. Security Safe is one of the more popular safe lines found in retail shoe stores. They make in-the-ground units used by JP and Meilink, and used to make the quad-bolt LaGard door. In fact, I call these safe doors LaGard doors for the lock they use. They appear under many names.

The major difference between the two bolt and the quad bolt doors is serviceability. The quad bolt doors are serviceable, and the dual bolt doors (old style) are not. The lock was installed and the unit was welded together. Because of a modification to the combination lock bolt when assembling the unit, the combination lock is not removable from the old-line doors.

Photograph one shows a door with everything removed. Hole #1 is the spindle hole, hole #2 is the 97 hole used for drilling and opening and #3 is the relock lever hole, used to de-activate the relocker. Hole #2 is large because it is necessary to remove the ball bearings in the hardplate assembly matrix to make a hole to get to the inner unit.

The way to determine if this is a dual bolt or quad-bolt door is simple. If the dial is in the middle of the door, it is a quad bolt door. If the dial and handle are offset towards the opening edge of the door, it is a new or old dual bolt door.

The main thing to keep in mind about the older type door is that it is welded together so that the combination lock cannot be removed or fully serviced. This is because of the slotted combination bolt seen in photograph two. When the lock is working, the crossbar of the bolt assembly fits into this slot, and so that it cannot become



1. The U.S. Security safe door: #1 is the spindle hole, #2 is the approx. 97 opening hole and #3 is the relock lever hole.



2. Side view of the LaGard bolt with groove.

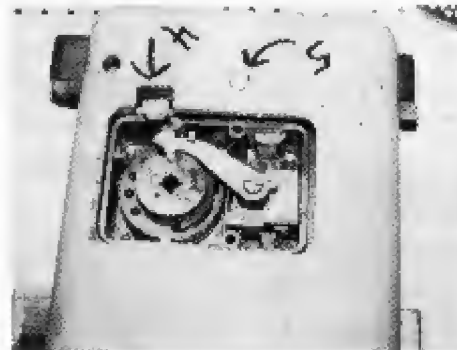

3. Inside view of non-servicable combination lock; #4 is the relock lever and #5 is the lever attaching rivet.

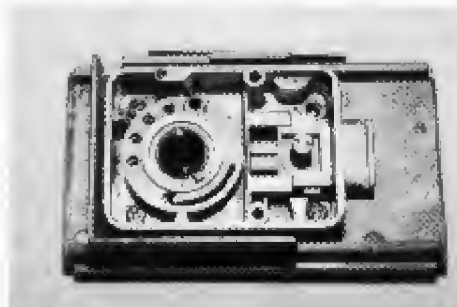

4. View of mounted combination lock mounting and hardplate assembly.

out-of-time, it is made unserviceable.

On the new door, there is a removable cover which lets you service all the lock parts. Photograph three shows the back of the door with the combination lock cover removed. The arrow labeled #4 is the relock lever activator button and #5 is the relock rivet which allows the relock bar to pivot and engage the upper bolt bar.

In this older type door the dial, drive cam, wheel pack, and the locking lever, are all that can be serviced. It is impossible to remove the lock case or lock bolt for replacement without grinding off the outside welds. The relocker is activated when the back cover is pushed up against the activator button.

The following pictures show what the unit would look like if we had x-ray vision. Photograph four shows the mounted combination lock on the hardplate assembly. My opening hole is shown through the wheel gates. The bolt with slot can be seen to the right ready to accept the lip of the opening bar assembly.

Photograph five shows the bolt bar assembly and how it fits into the slot of the combination lock bolt. Also not in this picture at about 11 o'clock there is a slot in the upper bolt bar. This slot is for the relock lever to fit into. This slot is only in the upper bar. Now, on to the relocker itself.

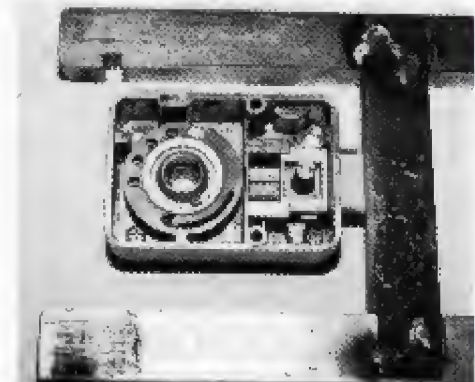

5. This is how the bolt and cross bolt assembly is installed on these locks.

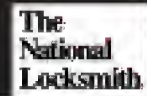

We have it all.

Quality, Value,  
& Service

[Click here for more information](#)

*Continued from page 142*

The following pictures are shot from under the previously welded-on cover. This is what you would see from the outside of the safe with proper orientation. Photo six shows the relock lever in the un-activated position. The bolts are free to slide back and forth with no restriction.

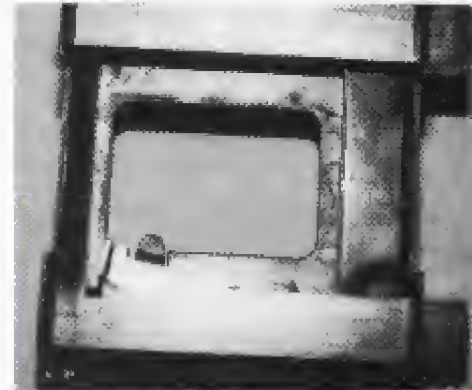

6. Bottom view of relock lever in the non-activated position.

Photograph seven shows what would happen if the lock was punched. When the cover goes past the button, it pushes the lever into the bolt bar and very effectively relocks the bolts. This can be undone from the front of the safe with a 1/4" hole. No hardplate will be encountered, and once the hole is made, it is easy to insert a small screwdriver and unseat this non-spring activated lever. Just pry it out of the way.

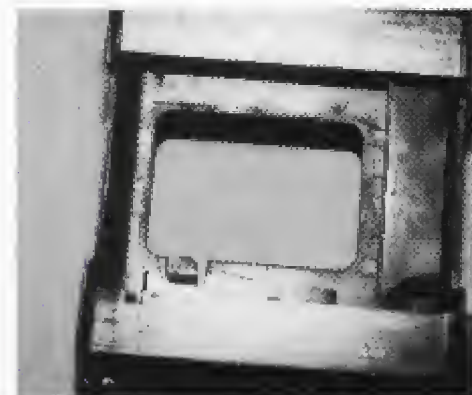

7. Relock lever activated in this position.

Again looking at the front of the combination lock mounting assembly (with our X-ray vision) from the front or outside of the safe, we would see the ball bearing nest with cover shown in photograph eight. The cover is numbered 1-20, and the hole I drilled into the lock to open can be seen at #17 on the index. The combination lock is mounted directly above this nest of ball bearings.

Now, let us remove the cover, and we see the ball bearings. These are smallish bearing about the size of

*Continued on page 161*



# The Lighter Side

Dress Codes of the Not so Rich and Famous



by Sara Probasco

I've been hearing a lot of comments, lately, about the way members of our profession dress at various meetings and conventions. A friend who was not involved in locksmithing once accompanied me to a meeting in another state. Upon entering the meeting hall, she glanced about at the locksmiths gathered there and whispered, "Not your average clean-cut business folk, are they?"

Her comment stunned and offended me. Many of those present were friends and acquaintances of mine. However, so is she, and she is not someone I consider snobbish.

Looking again, I tried to see them through her eyes. Many of the men were dressed in jeans or overalls and T-shirts. Some wore work shirts. A few had on slacks and open-neck sport shirts. The majority of women wore knit slacks or jeans and T-shirts or blouses with the shirt-tails out. Although there was nothing wrong in what they wore, as a group they didn't appear to have "spiffed up" any for the occasion.

Putting the comment in context, I had to remember that my friend was a professional woman, accustomed to dressing smartly among others who did likewise at her office. A convention or seminar meant, to her, looking her best in a dress or suit, hosiery, and "sensible" mid-heels, with her hair attractively coiffed and her make-up and nail polish properly applied.

Needless to say, most members of the

group before us did not reflect the image of the business professional.

"We work hard all week. After hours and on the weekends, we want to dress comfortably and relax," I hear myself and others say. Fine. That's understandable, if we plan to remain around the house. However, I have seen fellow locksmiths and their wives or husbands staying at luxury hotels and attending dinner outings and suppliers' hospitality hours at state and national conventions dressed in sloppy shirts and cut-offs, long past the cut-off age! And we want the world to recognize us as professionals!?! Come on, now, fellows and gals. We can't have it both ways.

There's the dilemma. How can we be "comfortable" without creating a wrong impression of ourselves as professionals?

We could resort to masks.

On Halloween many business people around our town wear costumes to work,

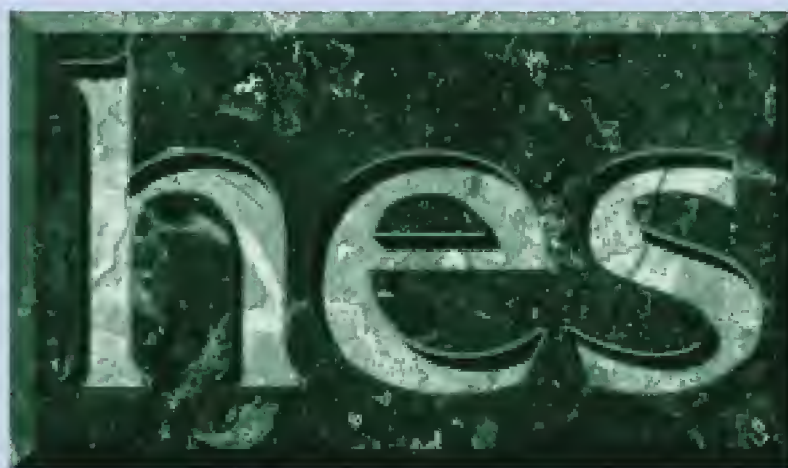

**The Innovation You Expect, with the  
Flexibility You Need!**

[Click here for more information](#)

There is a parade, right after school, and the town is filled with spooks and goblins from morning until bedtime. So far, I've never managed to fool anyone with my costumes.

One year, I dressed as a horrible witch, complete with elongated, wart-covered nose, red-rimmed eyes and a vicious cackle. I thought I had done a good job of disguising myself with make-up and costume until a few days later, when I ran into a woman and her young son at the shopping center.

They had come into our locksmith store on Halloween day and had seen me in my full regalia. On that later day, the boy promptly hid behind his mother's skirt when he saw me coming across the parking lot. As I approached, he kept her between us.

"Johnny, what's the matter with you?" his mother said. "That nice lady is not going to hurt you."

"Yes, she is!" he cried. "I saw her on Halloween. She's a witch!"

So much for the make-up.

It's interesting, how people sometimes identify us by what we wear. When working, Don usually dresses in dark blue work pants and a red and white striped uniform shirt with his company name embroidered on it. To one pocket, he clips his picture-identification badge. He also wears one of his many "Gatsby" caps, most of which are of bold, flowered fabric in outrageous colors. These caps have become his trademark.

Recently, his photograph appeared in the local newspaper along with a news article regarding his Certified Master Locksmith status. When photographed he was not wearing his cap.

"Congratulations. Saw the article about you in the paper, yesterday. That's quite an accomplishment," commented one of our customers the following morning. "But they put the wrong fellow's picture with it."

"That was me, all right," Don said.

"Nope, it was some other fellow," the man insisted. "You always wear that funny-looking cap."

Not always, I could have told him.

You may remember my relating events of the evening when we hosted a murder-mystery party. The "crime" was set in the Orient, and our guests had been encouraged to dress in costumes befitting the characters they would be portraying as we attempted to solve the murder.

I had braided black pantyhose into a "pigtail" for Don, and he wore a long, blue "Happy Coat." Complete with appropriate make-up, he looked the part of an ancient, Oriental sage.

One of our guests, portraying a military personage, arrived for the occasion in a

rented General Chang costume.

Needless to say, a lockout call came during the course of the evening, and the two of them departed in Don's service van to assist the lady in distress.

That really blew the dress code.

"Do you gentlemen live here, in Uvalde?" the elderly lady inquired, squinting to get a better look. "I don't believe I know you."

Perhaps it was just as well, under the circumstances.

In all fairness, while evaluating the dress code among locksmiths, we should reiterate the experience of the locksmith in Seguin, Texas whose wife runs a luxury limousine service. They had decided to drive one of their vehicles to a formal affair they were invited to attend in San Antonio. As they were about to leave home, they received a lockout call. Stopping en route, the locksmith stepped from the sparkling white

stretch limo in full tuxedo and gave his customer "white glove" service he'll not soon forget.

Perhaps clothes aren't so important in this business, after all. At least, that was what a locksmith on Padre Island, Texas, apparently decided. He's been a member of "Naturalists of South Padre Island" for ten years. In fact, when you dial the telephone number listed for the organization, the locksmith is the one who answers, according to a recent article in the Valley Freedom Newspapers. When enjoying nude sunbathing on the beach, he and his fellow naturalists try not to be obtrusive, he says.

His business card features a nude man holding a large key.

One can't help wondering what this man might not wear to a locksmith convention, or where he would clip his...Well, never mind. §



**LOCKMASTERS  
SECURITY  
MANAGEMENT**  
TM

*Click here  
for more  
information*

Providing  
quality tools,  
parts, and  
service for  
the security  
professional.



## Letters

*Continued from page 6*

who gets here first gets the job."

2) "I don't have that amount, will you trust me for it?"

3) Twice I have been asked to take it out in trade.

4) No one is there, when you are.

5) The address is wrong, and there's no phone.

6) They say they're in town and they're 20 miles out.

7) I'll meet you there (maybe)?"

8) "Oh, that's the wrong car, I'm sorry."

9) It won't work. "Before you touch it exactly how much will it cost?"

10) "I found my keys after I called you, sorry about that."

11) "I need you right now. How long will it take you to get there? 10 minutes? Too long, bye."

12) "I need you right now, I've had this problem for two weeks."

13) "The man in the tow truck said he couldn't open it and a locksmith charges too much."

14) "I just want to borrow one of those tools for a minute."

15) "Do you have a coat hanger I can borrow?"

16) "Just tell me how to do it."

These are some of my favorite phone call comments:

1) "Do you sell skeleton keys?" "Which one?" I ask. "Well let me have them all and I'll bring back the ones that don't work."

2) "Well if you don't want to help me, I'll call your competition."

3) "I might need you at 4:00 tomorrow, so leave your schedule open."

4) "Is the owner in?"

I found my old tool box the other day. In it was a slim jim, coat hanger, screwdriver, and four assorted car locks. Now I can't find a van big enough. In my old shop I had two key machines, three key racks, pin kits, assorted locks. Now I have six key machines, nine key racks, a code cutter, an attache full of car opening tools, two book cases full, two encyclopedias and a bunch of assorted locks.

The auto manufacturers are constantly changing their products. If they kept everything the same, there would be no need for designers, new

manufacturers, increased profits, etc.

It's a necessary part of life. We must keep expanding and increasing inventory. Expanding knowledge, raising our prices, convincing the customer we are here to help solve their problems, and keep them coming back for more.

God I love this business!

Brad & Paul's Lock & Key

Ohio

## U.S. Security Safe

*Continued from page 144*

B.B.'s. They are also the same size as the ball detent ball bearing in the case of the lock below the combination bolt. These are nasty little things to try and drill through, and in fact, you cannot.

The procedure to by-pass these little "hardies" is to drill a large hole, 3/8" to 7/16" and remove them with a punch and a magnet. After they are removed, you can continue drilling for a read and transfer, or a direct read at #97. The beauty of this is that you do not need a hardplate drill to effect an opening. After removing the bearings, the rest of the material is soft.

Remember the numbered cover to the nest in photograph eight? Well these numbers probably correspond to the through-drilled holes shown in photograph nine. It is almost impossible to grind this door and remove this welded unit to see if any of the ball bearings were left out of the matrix.

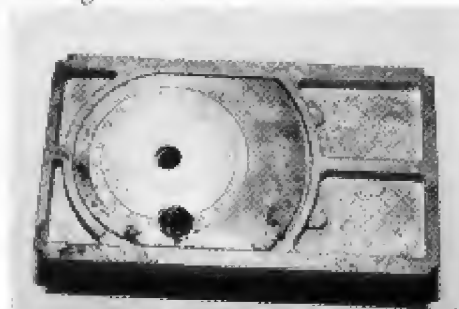

8. View from the front of the hardplate/mounting assembly. Note the "nest" cover is numbered from 1-20. Hole at #17.

I heard unfounded rumors that some of the ball bearings are left out so that no hard plate or bearing drilling would be encountered if you knew the exact and precise point to penetrate my safe. My hole was precisely on the end of the lever, and I thought that there were no bearing at this point. I made the hole larger, however, and removed 5 ball

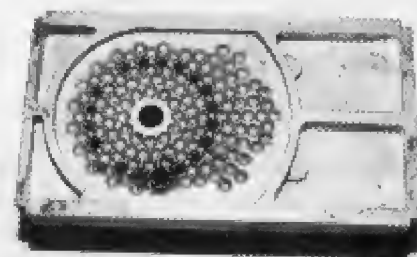

9. Ball bearings removed showing several through holes in the nest.

bearings so I could see and photograph the inside of the unit. It made drilling much easier.

Now, for repair of the unit. There isn't any. When I drill open a safe these days, at least on the newer units, I always replace the entire lock and fill or weld the hole I made. On this unit, one cannot replace the lock, but you can replace the door. Doors from Larry McCall are all interchangeable. The dual-bolts will replace the quad-bolts, and the newer dual bolts will replace the old quad bolts.

The door measures 12-3/4" square, not including the hinge mechanism extension. These doors are used in both in-the-floor and above-floor safes. They are quite popular. When I get to open a newer dual bolt door I will discuss complete servicing and the new type spring-activated relock device that these newer doors incorporate.

Open and Prosper. §

## Pittsburg Safes

*Continued from page 156*

with the fence. The handle is now rotated counterclockwise; the safe is open.

Photograph eight shows us the lock arrangement in the Pittsburg. You can see my drilled hole just above the wheels. This OB-type lock was manufactured by Sargent & Greenleaf many moons ago. It actually operates more like a Yale HE, in that the dial does not come to a stop on the last turn. After the wheel gates are lined

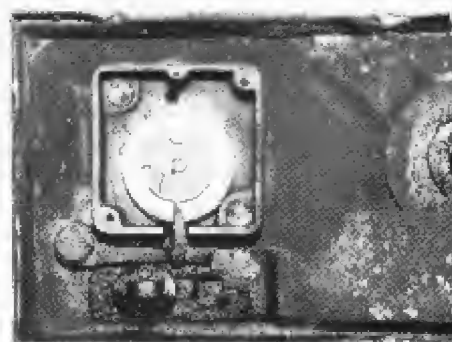

8. Lock arrangement is shown here.

up, you must set the dial on 100 to line up the driver gate with the fence. When the handle is rotated it forces the fence up into the gates. It is that characteristic that makes manipulation a very viable method of entry on these safes. And the truth is that the only reason I didn't manipulate this one is that I had reservations about the customer coughing up the dough. He had complained enough, and I wanted him to feel he was getting his money's worth. Given the absence of hardplate, which makes drilling a Pittsburg a piece of cake, is hard to argue convincingly that either method is objectively preferable. Suffice it to say that I prefer a moving stage to a still one.

Photograph nine gives us a close-up of the lock that I cannot find in any of my antique S&G catalogs. In this photograph we can see the lever at the bottom of the lock. There are three 2 1/8" diameter wheels and a rear-mounted driver. Remember, the dial does not come to a stop; you have to rotate the handle and force the lever up into the wheels.

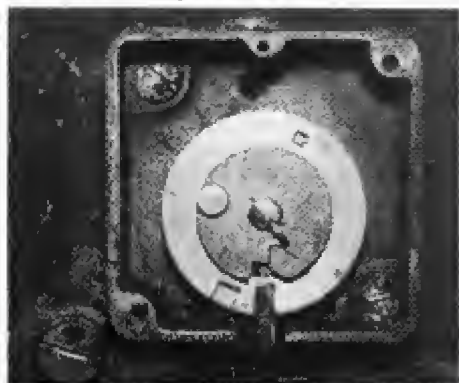

9. Close-up of the Pittsburg lock.

In photograph 10 all the parts of the lock have been removed for our inspection. Look at all those spacing washers!

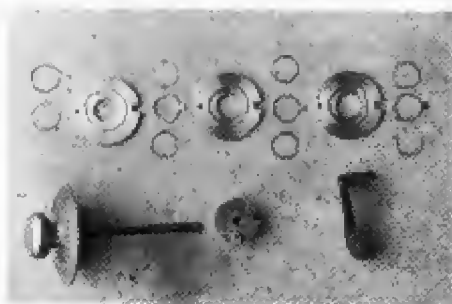

10. The components of the lock

Well, that about wraps it up for this month. I have never been there, but Pittsburg was a great place to visit. Where shall we travel to next month ?§



**HPC has it all:  
Key Machines, Software,  
Books, Car Openers, Pick  
Sets, Tools, Door Guards,  
and Key Cabinets**

[Click here for more information](#)